

DS1000 Series Displacement Sensors Reference



2020 September 11
Revision: 9.6.0.SR2.1

Legal Notices

The software described in this document is furnished under license, and may be used or copied only in accordance with the terms of such license and with the inclusion of the copyright notice shown on this page. Neither the software, this document, nor any copies thereof may be provided to, or otherwise made available to, anyone other than the licensee. Title to, and ownership of, this software remains with Cognex Corporation or its licensor. Cognex Corporation assumes no responsibility for the use or reliability of its software on equipment that is not supplied by Cognex Corporation. Cognex Corporation makes no warranties, either express or implied, regarding the described software, its merchantability, non-infringement or its fitness for any particular purpose.

The information in this document is subject to change without notice and should not be construed as a commitment by Cognex Corporation. Cognex Corporation is not responsible for any errors that may be present in either this document or the associated software.

Companies, names, and data used in examples herein are fictitious unless otherwise noted. No part of this document may be reproduced or transmitted in any form or by any means, electronic or mechanical, for any purpose, nor transferred to any other media or language without the written permission of Cognex Corporation.

2020 September 11 7:10 PM

Revision: 9.6.0.SR2.1

Copyright © 2016. Cognex Corporation. All Rights Reserved.

Portions of the hardware and software provided by Cognex may be covered by one or more U.S. and foreign patents, as well as pending U.S. and foreign patents listed on the Cognex web site at: cognex.com/patents.

The following are registered trademarks of Cognex Corporation:

Cognex, 2DMAX, Advantage, AlignPlus, Assemblyplus, Check it with Checker, Checker, Cognex Vision for Industry, Cognex VSOC, CVL, DataMan, DisplayInspect, DVT, EasyBuilder, Hotbars, IDMax, In-Sight, Laser Killer, MVS-8000, OmniView, PatFind, PatFlex, PatInspect, PatMax, PatQuick, SensorView, SmartView, SmartAdvisor, SmartLearn, UltraLight, Vision Solutions, VisionPro, VisionView

The following are trademarks of Cognex Corporation:

The Cognex logo, 1DMax, 3D-Locate, 3DMax, BGAll, CheckPoint, Cognex VSoC, CVC-1000, FFD, iLearn, In-Sight (design insignia with cross-hairs), In-Sight 2000, InspectEdge, Inspection Designer, MVS, NotchMax, OCRMax, PatMax RedLine, ProofRead, SmartSync, ProfilePlus, SmartDisplay, SmartSystem, SMD4, VisiFlex, Xpand

Portions copyright © Microsoft Corporation. All rights reserved.

Portions copyright © MadCap Software, Inc. All rights reserved.

Other product and company trademarks identified herein are the trademarks of their respective owners.

Preface

This document describes the Cognex Displacement DS1000 series sensors.

Symbols

The following symbols indicate safety precautions and supplemental information:

 **WARNING:** This symbol indicates a hazard that could cause death, serious personal injury or electrical shock.

 **CAUTION:** This symbol indicates a hazard that could result in property damage.

 **Note:** This symbol indicates additional information about a subject.

 **Tip:** This symbol indicates suggestions and shortcuts that might not otherwise be apparent.

Cognex 3D Displacement Sensors

Cognex 3D displacement sensors combine GigE Vision and laser-stripe illumination to generate information about three-dimensional objects that cannot easily be generated by cameras that acquire two-dimensional images. Each sensor projects a triangular laser plane onto an object as it passes within view.

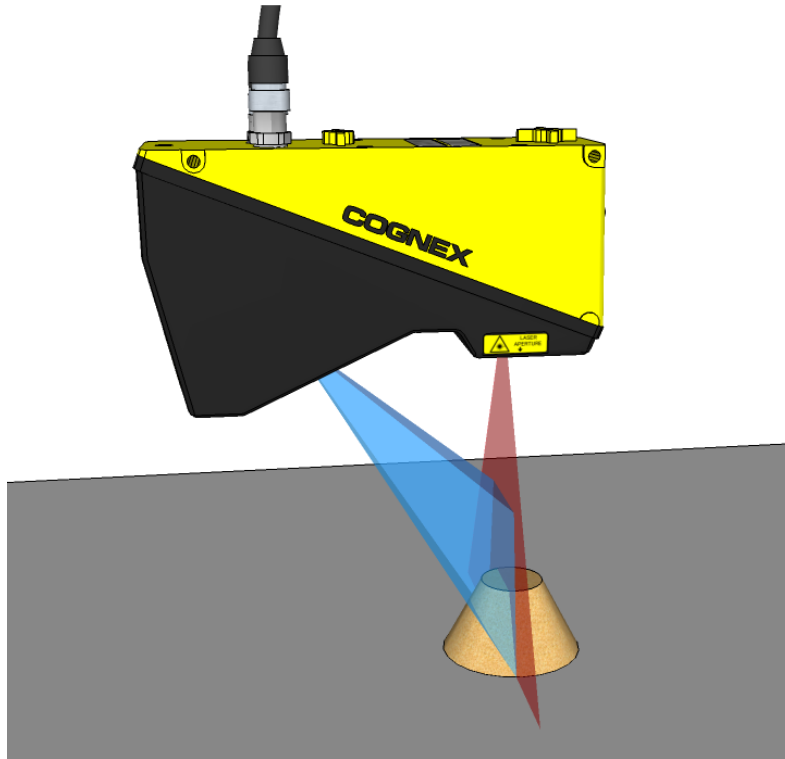

The illumination of the laser plane generates a laser stripe whose shape is determined by the surface of the object.

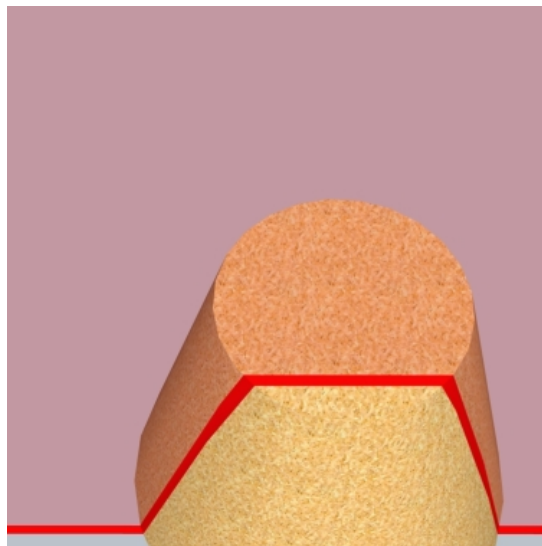

The integrated camera uses a red long-pass filter to capture an intensity image of the laser stripe:

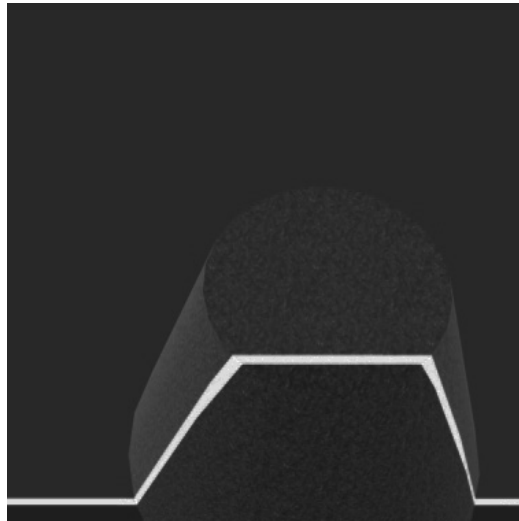

The image of the laser stripe represents a cross-section of the object under inspection. Your application might use this cross-section data, or you can use a 3D displacement sensor to acquire a series of images while the object moves past and then combine the height data of each image to generate a synthetic 2D image containing height profile information in real-world coordinates.

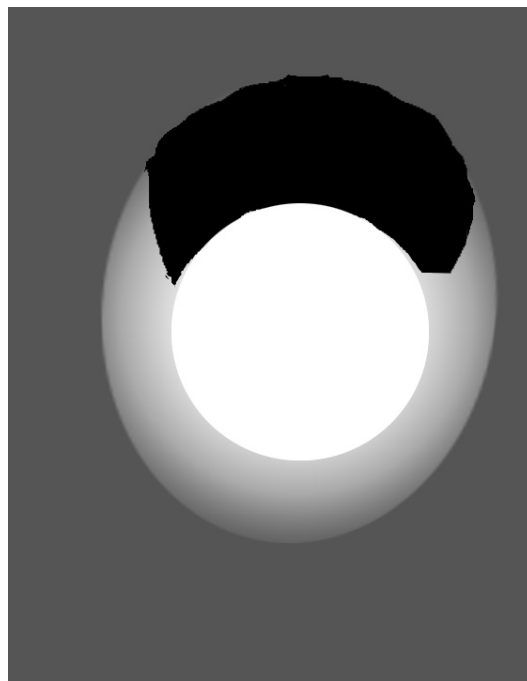

Your Cognex software supports a variety of 3D vision tools for performing tasks such as:

- Generating information about a planar surface
- Generating height or volume calculations
- Analyzing a cross-section of the object

The synthetic image can also be passed to any number of traditional vision tools to perform tasks such as pattern matching or optical character recognition.

Precautions

To reduce the risk of injury or equipment damage, observe the following precautions when you install the Cognex product:

- Route cables and wires away from high-current wiring or high-voltage power sources to reduce the risk of damage or malfunction from the following causes: over-voltage, line noise, electrostatic discharge (ESD), power surges, or other irregularities in the power supply.
- Changes or modifications not expressly approved by the party responsible for regulatory compliance could void the user's authority to operate the equipment.
- Ensure that the cable bend radius begins at least six inches from the connector. Cable shielding can be degraded or cables can be damaged or wear out faster if a service loop or bend radius is tighter than 10X the cable diameter.
- This device is certified for office use only and if used at home, there can be frequency interference problems.
- This device should be used in accordance with the instructions in this manual.
- All specifications are for reference purposes only and can change without notice.

DS1000 Series Models

The following sensors contain a class 2M laser:

Model	Class 2M Laser
DS1050 (821-0116-5R)	√
DS1101 (821-0116-3R)	√
DS1300 (821-0116-4R)	√

Accessories

The following optional components can be purchased separately. For a list of options and accessories, contact your Cognex sales representative.

Cables

Note: Cables are sold separately.

Power and I/O

For more information, refer to [I/O Cable on page 26](#) for the pin-out of the unterminated flying leads.

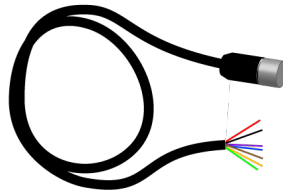

Length	Description	Part Number
5m	Cable Power and I/O, M12 to flying lead, straight	CBL-05P2-S1
20m		CBL-20P2-S1

Refer to [DB15 Connector on page 27](#) for the pin-out of the DB15 connector.

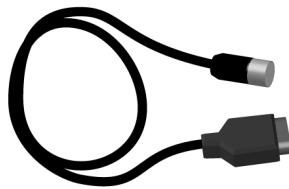

Length	Description	Part Number
5m	Cable Power and I/O, M12 to DB15, straight	CBL-05P2-S2
20m		CBL-20P2-S2

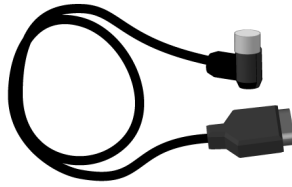

Length	Description	Part Number
5m	Cable Power and I/O, M12 to DB15, right-angle	CBL-05P2-R2
20m		CBL-20P2-R2

Ethernet Cables

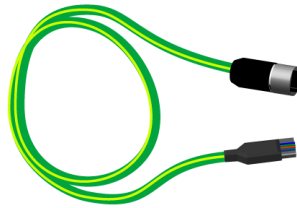

Length	Description	Part Number
0.6m	M12 to RJ-45, straight	CCB-84901-1001-00
2m		CCB-84901-1002-02
5m		CCB-84901-1003-05
10m		CCB-84901-1004-10
15m		CCB-84901-1005-15
30m		CCB-84901-1006-30

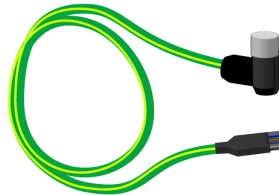

Length	Description	Part Number
2m	M12 to RJ-45, right-angle	CCB-84901-6005-02
5m		CCB-84901-6001-05
10m		CCB-84901-6002-10
15m		CCB-84901-6003-15
30m		CCB-84901-6004-30

Mounting Hardware

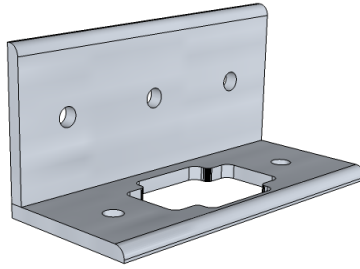

Description	Part Number
Mounting bracket and M6 screws.	DS-BKT-000

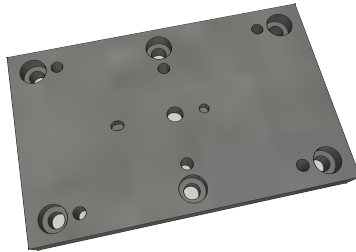

Description	Part Number
High-accuracy mounting plate and M6 screws.	DS-MPHA-00

Steel Enclosure



Description	Part Number
IP69K stainless steel enclosure	DS-ENC-SS-00

Laser Safety Warnings

DS1050
DS1101
DS1300



**LASER LIGHT, DO NOT STARE INTO BEAM:
CLASS 2M LASER PRODUCT
FAILURE TO FOLLOW THESE
INSTRUCTIONS MAY CAUSE SERIOUS
INJURY**

Cognex places the following labels on every 3D displacement sensor:

DS1000 Series

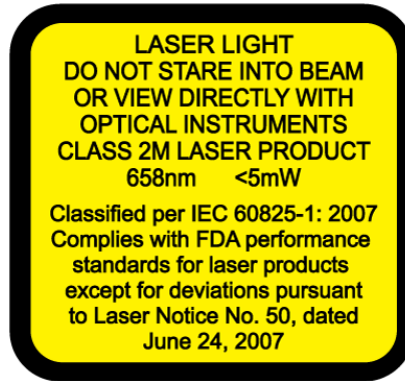

If you need more information on the collection, reuse, and recycling systems, please contact your local or regional waste administration. You may also contact your supplier for more information on the environmental performance of this product.



Note: AVOID EXPOSURE - LASER RADIATION IS EMITTED FROM THIS APERTURE

Warnings and Notices

Cognex provides the following warnings and notices:

- Do not stare into the beam.
- Do not view directly with optical instruments (magnifiers).
- Do not place optical components (mirrors) into the beam.
- Design test fixtures in such a way that unintentional viewing of the beam is prevented.
- Switch off the laser when not in use.
- Avoid the use of highly reflective materials. If you cannot, try to angle the part so unintentional viewing of the reflection is prevented.
- Terminate (block) unused beams.
- Keep the laser plane horizontal or pointing downwards.
- Report any issues that may have an impact on laser safety to your supervisor or Laser Safety Officer.
- There is no scheduled maintenance necessary to keep the product in compliance.
- Under no circumstances should you operate the sensor if it is defective or the seal damaged. Cognex Corporation cannot be held responsible for any harm caused by operating a faulty unit.
- Under no circumstances should you modify in any way the sensor or its housing.
- Use of controls or adjustments or performance of procedures other than those specified herein may result in hazardous radiation exposure.
- When moving the unit from a very hot environment to a cold environment please allow the unit to equalize in a room temperature environment for 2 hours between temperature extremes.

If you need more information on the collection, reuse, and recycling systems, please contact your local or regional waste administration. You may also contact your supplier for more information on the environmental performance of this product.

DS1050 Sensor Specifications

Refer to the following sections for DS1050 hardware and laser specifications.

Hardware Specifications

Weight	700 g
Operating Temperature	0 °C to 50 °C (32 °F to 122 °F)
Storage Temperature	-10 °C to 80 °C (14 °F to 176 °F)
Maximum Humidity	10% to 85%, non-condensing (Operating and Storage)
Environmental	IP65 (with Cognex recommended IP65 Ethernet and Power and I/O cables)
Power Supply Requirements	Voltage: +24 VDC +/- 10% Current: 500 mA max
Trigger	Input voltage limits: Trig+ - Trig - = - 24VDC to +24VDC Input ON: > 10 VDC (> 6 mA) Input OFF: < 2 VDC (< 1.5 mA)
Encoder Input Specification	Differential: A+/B+: 5-24V (50 kHz max) A-/B-: Inverted (A+/B+) Single Ended: A+/B+: 5-24V (50 kHz max) A-/B-: VDC = ½ (A+/B+)
Working Distance	87 to 163 mm
Ethernet	<ul style="list-style-type: none"> • Gigabit Ethernet interface • Integrated link and traffic LEDs • Standard M12-8 female connector
Shock	50 G's Half-Sine with a pulse of 11 milliseconds duration. Test conducted while instrumented in a shipping package dropped from a maximum of 36 inches
Vibration	8 G's RMS Random Between 10-500 Hz for a duration of 30 minutes.
Certification	
Altitude rating	2 km / 6561 ft

Laser Specifications

This laser product is designated as Class 2M.

Wavelength	658 nm	
Laser Power for Classification	< 5 mW	
Laser Maximum Total Power	< 40 mW	
Minimum Divergence	vertical: < 1.5 mrad horizontal: 32 degrees	
Laser Line Thickness (FWHM)	< 0.4 mm	
Sensor Size	1024x768 pixels	
X Resolution	Top	0.059 mm
	Bottom	0.090 mm

Y Resolution	This value depends on Encoder Resolution, the Distance per Cycle and the Steps per Line settings.	
Z Resolution	Top	0.005 mm
	Bottom	0.014 mm

DS1101 Sensor Specifications

Refer to the following sections for DS1101 hardware and laser specifications.

Hardware Specifications

Weight	700 g
Operating Temperature	0 °C to 50 °C (32 °F to 122 °F)
Storage Temperature	-10 °C to 80 °C (14 °F to 176 °F)
Maximum Humidity	10% to 85%, non-condensing (Operating and Storage)
Environmental	IP65 (with Cognex recommended IP65 Ethernet and Power and I/O cables)
Power Supply Requirements	Voltage: +24 VDC +/- 10% Current: 500 mA max
Trigger	Input voltage limits: Trig+ - Trig - = - 24VDC to +24VDC Input ON: > 10 VDC (> 6 mA) Input OFF: < 2 VDC (< 1.5 mA)
Encoder Input Specification	Differential: A+/B+: 5-24V (50 kHz max) A-/B-: Inverted (A+/B+) Single Ended: A+/B+: 5-24V (50 kHz max) A-/B-: VDC = ½ (A+/B+)
Working Distance	135 mm to 355 mm
Ethernet	<ul style="list-style-type: none"> • Gigabit Ethernet interface • Integrated link and traffic LEDs • Standard M12-8 female connector
Shock	50 G's Half-Sine with a pulse of 11 milliseconds duration. Test conducted while instrumented in a shipping package dropped from a maximum of 36 inches
Vibration	8 G's RMS Random Between 10-500 Hz for a duration of 30 minutes.
Certification	
Altitude rating	2 km / 6561 ft

Laser Specifications

This laser product is designated as Class 2M.

Wavelength	658 nm	
Laser power for classification	< 5 mW	
Laser maximum total power	< 40 mW	
Minimum Divergence	vertical: < 1.5 mrad horizontal: 32 degrees	
Laser Line Thickness (FWHM)	< 0.5 mm	
Sensor Size	1024x768 pixels	
X Resolution	Top	0.079 mm
	Bottom	0.181 mm
Y Resolution	This value depends on Encoder Resolution, the Distance per Cycle and the Steps per Line settings.	
Z Resolution	Top	0.010 mm
	Bottom	0.052 mm

DS1300 Sensor Specifications

Refer to the following sections for DS1300 hardware and laser specifications.

Hardware Specifications

Weight	700 g
Operating Temperature	0 °C to 50 °C (32 °F to 122 °F)
Storage Temperature	-10 °C to 80 °C (14 °F to 176 °F)
Maximum Humidity	10% to 85%, non-condensing (Operating and Storage)
Environmental	IP65 (with Cognex recommended IP65 Ethernet and Power and I/O cables)
Power Supply Requirements	Voltage: +24 VDC +/- 10% Current: 500 mA max
Trigger	Input voltage limits: Trig+ - Trig - = - 24VDC to +24VDC Input ON: > 10 VDC (> 6 mA) Input OFF: < 2 VDC (< 1.5 mA)
Encoder Input Specification	Differential: A+/B+: 5-24V (50 kHz max) A-/B-: Inverted (A+/B+) Single Ended: A+/B+: 5-24V (50 kHz max) A-/B-: VDC = ½ (A+/B+)
Working Distance	180 mm to 905 mm
Ethernet	<ul style="list-style-type: none"> • Gigabit Ethernet interface • Integrated link and traffic LEDs • Standard M12-8 female connector
Shock	50 G's Half-Sine with a pulse of 11 milliseconds duration. Test conducted while instrumented in a shipping package dropped from a maximum of 36 inches
Vibration	8 G's RMS Random Between 10-500 Hz for a duration of 30 minutes.
Certification	
Altitude rating	2 km / 6561 ft

Laser Specifications

This laser product is designated as Class 2M.

Wavelength	658 nm	
Laser Power for Classification	< 5 mW	
Laser Maximum Total Power	< 40 mW	
Minimum Divergence	vertical: < 1.5 mrad horizontal: 32 degrees	
Laser Line Thickness (FWHM)	< 0.8 mm	
Sensor Size	1024x768 pixels	
X Resolution	Top	0.101 mm
	Bottom	0.457 mm
Y Resolution	This value depends on Encoder Resolution, the Distance per Cycle and the Steps per Line settings.	
Z Resolution	Top	0.016 mm
	Bottom	0.265 mm

System Layout

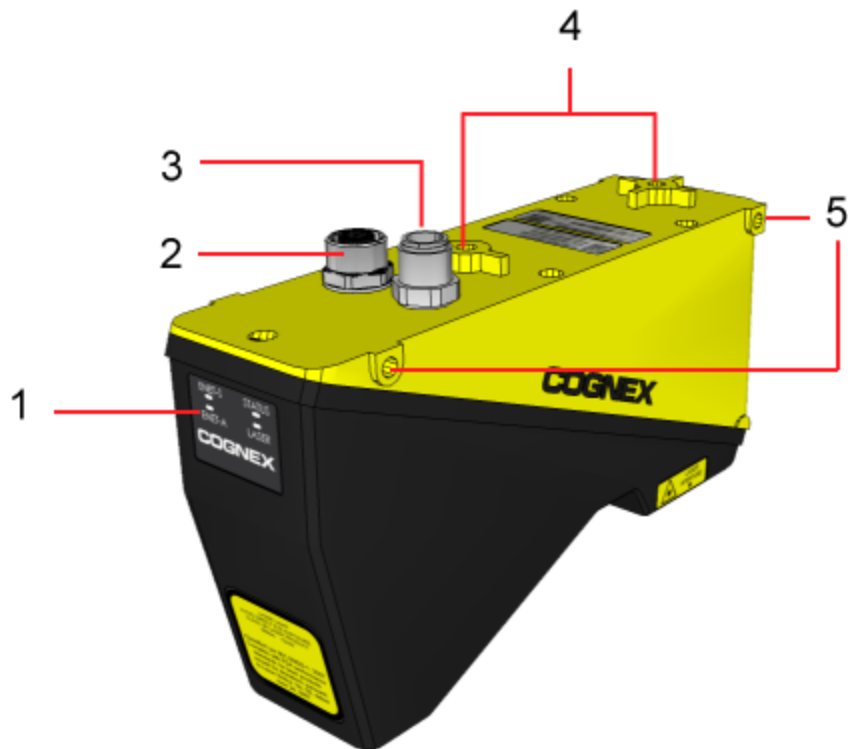

Component	Description
1	Status LEDs
2	Ethernet connector
3	24V DC power + I/O + Encoder connector
4	M6 mounting boss
5	M4 through-body mounting holes

Safe Handling

- Retain the original packaging supplied by Cognex and re-use it whenever you ship your sensor.
- Follow the instructions in [Sensor Maintenance on page 20](#) for details on cleaning the sensor.
- Refer to the topic [Safety and Regulatory on page 49](#) for electrical safety information.
- Always observe the environmental limits. Subjecting the unit to shock, vibration or rough handling in excess of the specified limits can cause the sensor to fail.

System LEDs

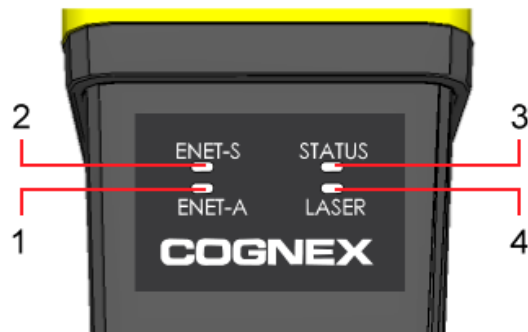

Connector	Indicator	Description
1	Ethernet Link	Blinks when there is Ethernet activity on the link, or is off to indicate there is no link with the host.
2	Ethernet Link Status	Blinks in groups of three when a 1000 Mbps connection is established with the host.
3	Sensor Status	Blinks approximately every 5 seconds when the sensor is running normally.
4	Laser Enabled	Lights while the laser is triggered.

Bottom View



Component	Description
1	High-accuracy planar mounting pins
2	Laser window CAUTION: AVOID EXPOSURE - LASER RADIATION IS EMITTED FROM THIS APERTURE
3	Camera window

Sensor Maintenance



LASER LIGHT, DO NOT STARE INTO BEAM OR VIEW DIRECTLY WITH OPTICAL INSTRUMENTS: CLASS 2M LASER PRODUCT

Component	Description
1	Laser window CAUTION: AVOID EXPOSURE - LASER RADIATION IS EMITTED FROM THIS APERTURE
2	Camera window

The windows to the camera and laser must be kept clean and free of defects to ensure proper operation. Any scratches, dust or dirt will impact the accuracy of acquired images.

CAUTION: Use care not to damage the anti-reflective coating on the windows.

Cognex makes the following recommendations for cleaning the laser and camera windows:

- Unplug the unit so the laser cannot be enabled.
- Use lint-free tissue or an optical grade cotton swab ("Q-tip").
- Use reagent-grade isopropyl alcohol.
- Use minimal pressure.
- Use several tissues or swabs.
- Start at the center of each window and spiral out to the edges.
- Rotate the tissue or swab during cleaning so dirt is not dragged across the surface.

Product Service



- Bring any performance issues to the attention of your Cognex sales representative.
- The sensor can only be serviced by a trained Cognex representative. Return the unit to Cognex for any service or repairs.
- Do not operate the sensor if the enclosure appears damaged.

Mounting the Sensor

Firmly mount the sensor so that the laser is perpendicular to the motion of travel. The accuracy and reliability of your 3D images relies on the three-dimensional coordinate system defined by the position of the sensor and the movement of objects that pass within its view.

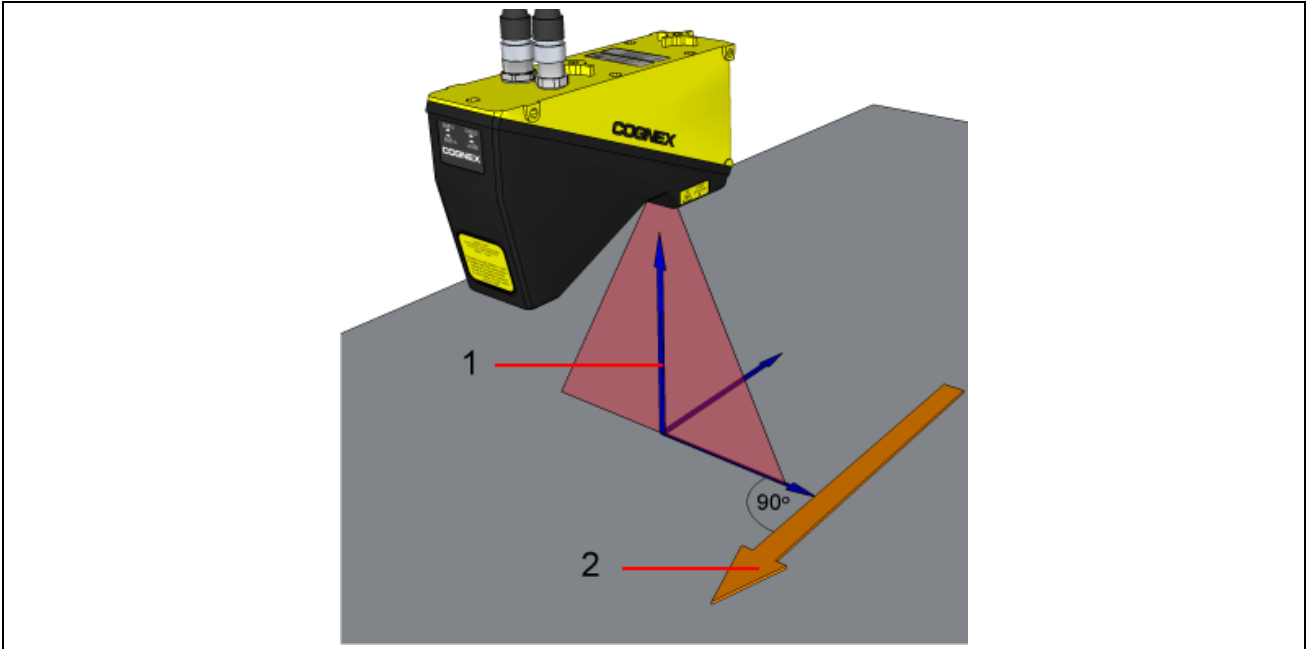

Feature	Description
1	A three-dimensional coordinate system where the origin is at the center of the laser plane on the surface of movement.
2	For best results, movement should be perpendicular to the laser plane.

Multiple sensors should be mounted coplanar with each other, spaced apart so that there is sufficient overlap between the laser plans to cover the required distance.

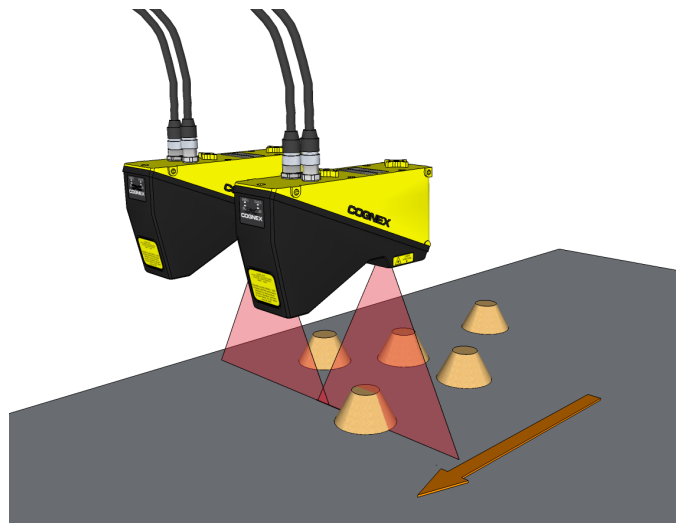

The sensor offers three mounting options:

- Recommended: Attach the sensor to the DS1000 series high-accuracy mounting plate. See the topic [High-Accuracy Mounting on page 22](#) for more information.
- Use the mounting bosses on the top of the device. See the topic [Top Mounting on page 25](#) for more information.
- Use the mounting through-body holes on the side of the device. See the section [Through-Body Mounting on page 25](#) for more information.

High-Accuracy Mounting

The mounting plate (part number DS-MPHA-00) accessory offers the following advantages when anchoring your sensor to your production environment:

- The laser plane will always be parallel to the mounting plate.
- Removing and replacing a sensor requires fewer steps and allows you to mount a new sensor in exactly the same position as the previous unit.

Be aware of the following mounting features for use with the mounting plate:

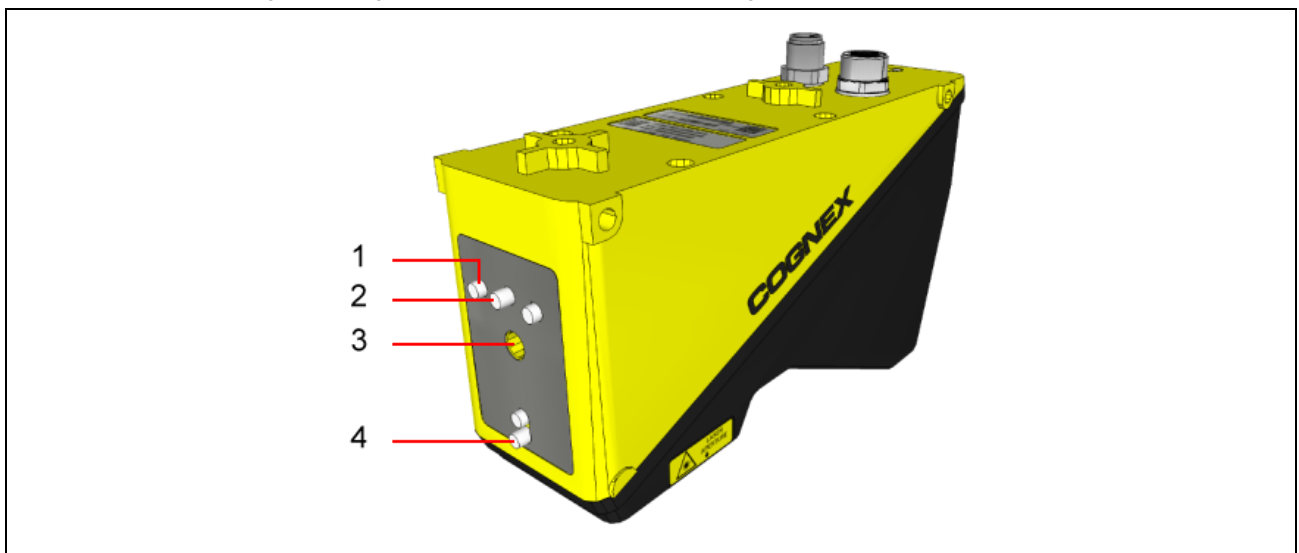

Feature	Description	Usage
1	Plane Pins (3 total)	Ensures that the laser plane is parallel to the mounting plate.
2	Location Pin	Constrains the rotation of the sensor around the Master Pin.
3	M6 screw thread	
4	Master Pin	

The mounting plate supports the corresponding holes:

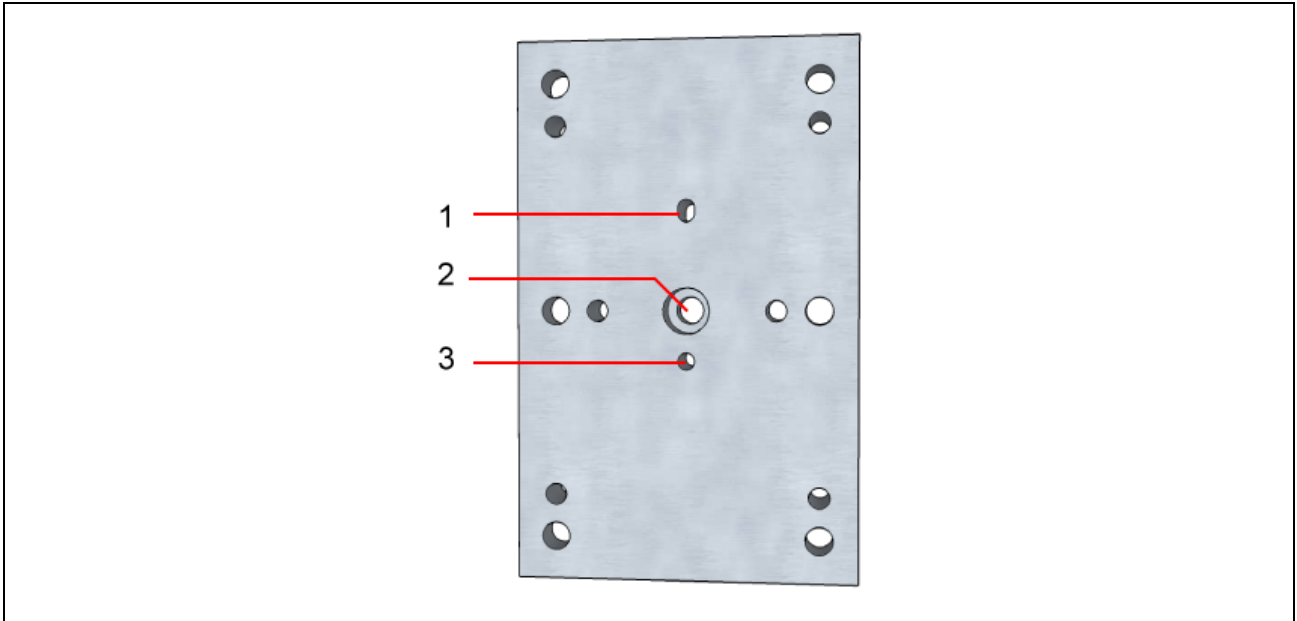

Feature	Description
1	Hole for Location Pin
2	Through-hole for M6 screw
3	Hole for Master Pin

To mount the sensor to the plate:

1. Align the Master Pin, the Location Pin and the through-hole for the M6 screw with the holes in the mounting plate.

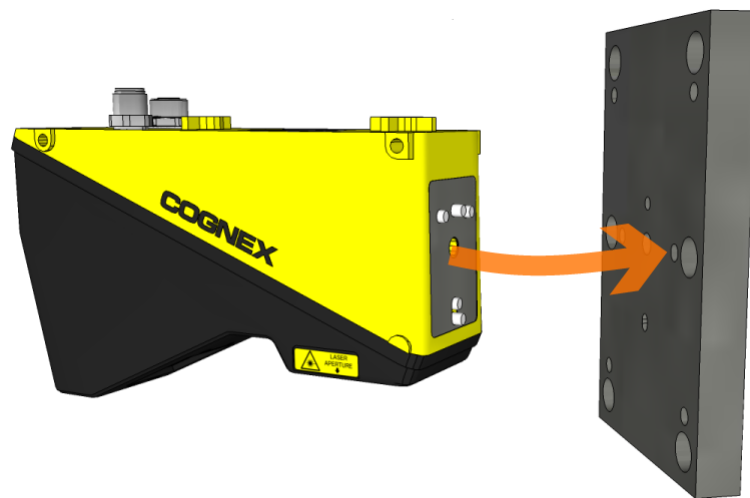

2. Confirm the three plane pins make contact with the mounting plate.

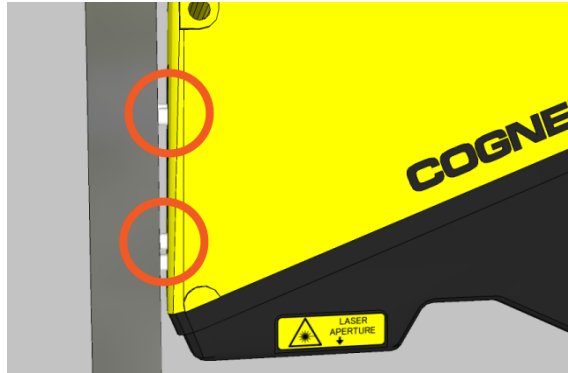

3. Insert and tighten the M6 screw.

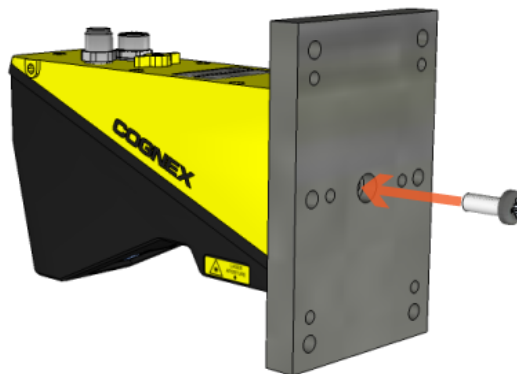

CAUTION: Observe torque limit: 2.2 Nm (19 Lb-In).

4. Mount the plate perpendicular to the direction of moment of the objects to be inspected.

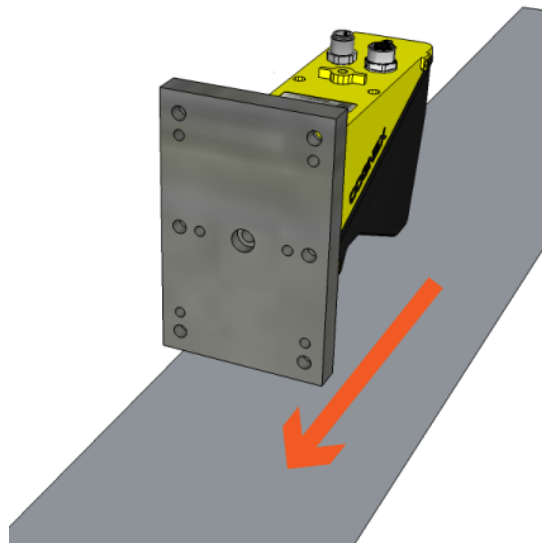

Top Mounting

Align the top-mounting bracket (DS-BKT-000) with the mounting bosses on top of the device, and attach the bracket with the M6 screws.

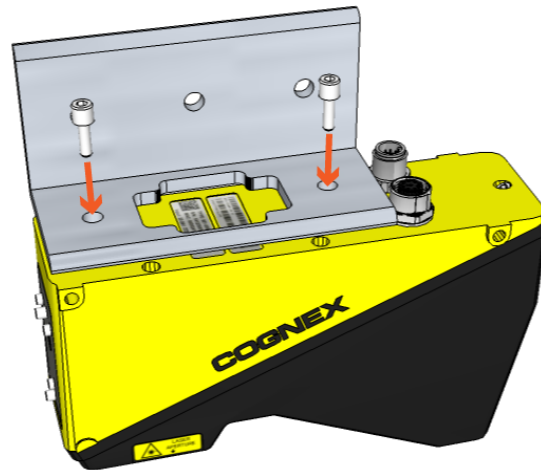

CAUTION: Observe torque limit: 2.2 Nm (19 Lb-In).

Through-Body Mounting

To mount your sensor using the through-body mounting option, insert rods or appropriate hardware through the sensor unit and use a clamping mechanism to prevent the sensor from shifting during operation.

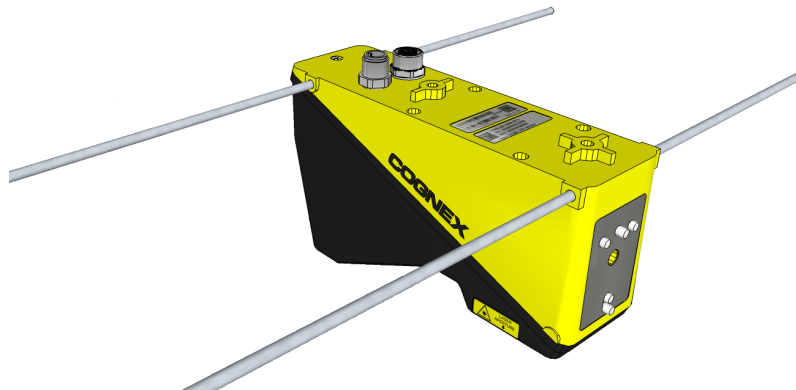

Note: For mounting multiple sensors with a coplanar view, Cognex recommends using mounting plates (part number DS-MPHA-00) for the highest accuracy.

I/O Cable

The Power and I/O cable provides access to trigger and inputs. You can clip unused wires short or use a tie made of non-conductive material to tie them back.

Pin #	Signals Name	Notes	Color
1	PhB+	Encoder "B" input (twisted pair)	Yellow
2	PhB-		White/Yellow
3	PhA+	Encoder "A" input (twisted pair)	Brown
4	PhA-		White/Brown
5	Trig+	Trigger	Violet
6	Trig-		White/Violet
7	+24VDC	Power	Red
8	GND	Ground	Black
9	Laser+	Not Used	Green
10	Laser-	Not Used	Orange
11	Ctrl+	Not Used	Blue
12	Ctrl-	Not Used	Grey

When wiring the sensor, observe the following precautions:

- Use a listed power supply with an output rated 24VDC, at least 500 mA, and marked Class 2, Limited Power Source (LPS). Any other voltage creates a risk of fire or shock and can damage the sensor. Refer to the following wiring diagram for connecting the sensor to power:

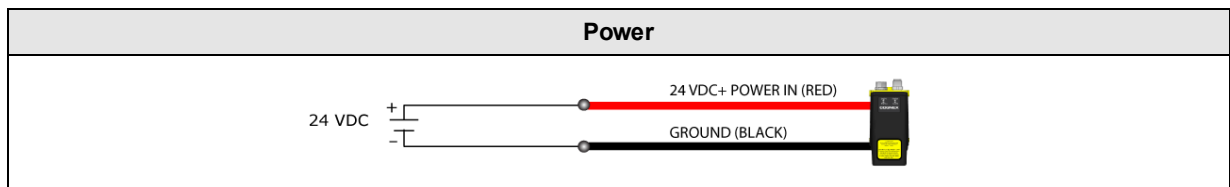

- Connect the cable or connector shield to earth ground.
- Pins 1, 2, 3, and 4 may be used for an encoder connection. The configuration that you set for your sensor using the Cognex software determines how those lines are used.



Tip: Cognex recommends unused encoder connections be tied to ground. If encoder signal inputs are left unconnected and your Cognex software is configured to use an encoder, the behavior of the encoder counter is undetermined.

- Route cables and wires away from high-current wiring or high-voltage power sources to reduce the risk of damage or malfunction from the following causes: over-voltage, line noise, electrostatic discharge (ESD), power surges, or other irregularities in the power supply.

DB15 Connector

The DB15 port provides power and trigger connections to the sensor through the I/O cable.

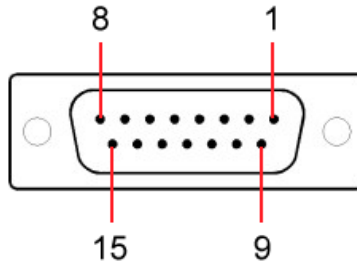

Pin Number	Signal Name
1	+24VDC power
2	Laser- (Not Used)
3	Laser+ (Not Used)
4	Ctrl+ (Not Used)
5	Ctrl- (Not Used)
6	Not Used
7	Not Used
8	-24VDC
9	Encoder A+
10	Encoder A-
11	Trigger+
12	Trigger-
13	Encoder B+
14	Encoder B-
15	Not Used

Ethernet Connector

The Ethernet connection uses an M12-8 female connector.

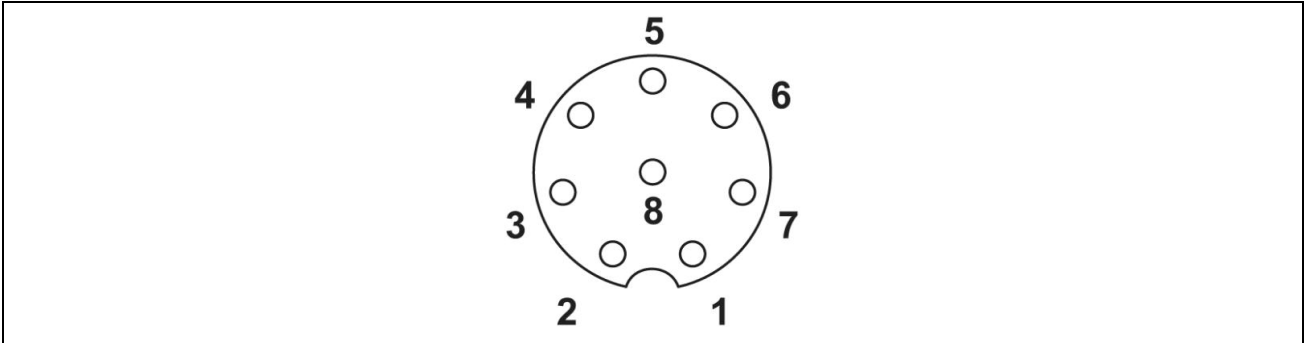

Ethernet Signal	RJ-45 Pin Number	M12-8 Pin Number
DA+	1	6
DA-	2	4
DB+	3	5
DB-	6	8
DC+	4	7
DC-	5	1
DD+	7	2
DD-	8	3

Image Acquisition

Your Cognex vision software captures image information and generates a synthetic image containing height profile information of each object that passes within view of the laser and camera contained within the DS1000 series sensor, as shown in the following example using a 3D display utility:

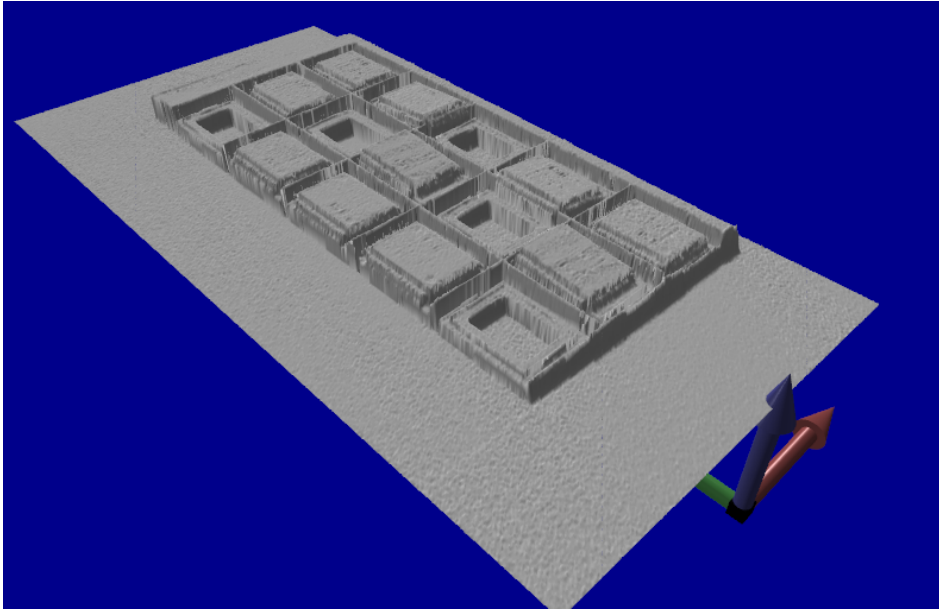

Image acquisition combines the use of the following:

- Encoders - electrical devices that convert movement of the conveyor system into electrical pulses
- Acquisition triggers - hardware devices that signal the start of an image acquisition
- Acquisition parameters - settings in your Cognex vision software that determine the size and resolution of each acquired image

Encoders

The DS1000 series sensor typically relies on electrical signals from an encoder to generate images, allowing the sensor to capture image information based on the speed of the moving object rather than predetermined exposure settings. Many vision applications use a rotary encoder attached to the conveyor system.

Note:

- The frequency of encoder pulses must not exceed 50 kHz.
- Using an encoder allows you to specify input and output delay values in pulse counts instead of real time units.
- The sensor supports a test encoder that generates encoder pulses internally. The test encoder can be used to acquire images without connecting a physical encoder, which can be useful as you develop your application or if you need to verify the operation of the sensor while debugging encoder connection issues.



A rotary encoder typically uses two output channels (A and B) to provide cyclical outputs as the encoder rotates. The signals are *quadrature* outputs - 90 degrees out of phase with each other. Each complete quadrature cycle consists of four rising or falling *pulse* edges. The number of cycles per encoder rotation depends on the specific encoder you use.

Signal A and B in Quadrature

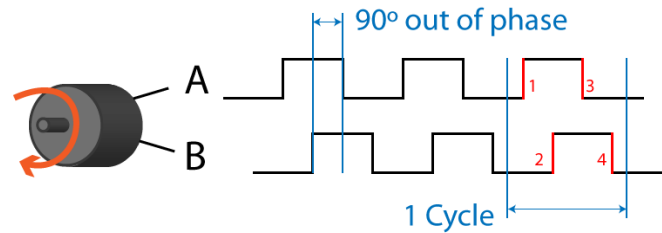

The *distance per cycle* is the physical distance that the conveyor system must travel to cause the encoder to output one full cycle. This distance can be calculated based on the dimensions of your encoder and the length of the image you want to acquire.

As you configure your Cognex vision software, you determine how encoder cycles affect image acquisition. See the topic [Encoder Resolution and Steps Per Line on page 32](#) for more information or refer to your Cognex software documentation.

The DS1000 series sensors support single-channel and dual-channel encoders.

- Single-channel encoders generate only one signal (A). Cognex recommends you use only the PhA+ input of the I/O cable with a single-channel encoder. Be aware that single-channel encoders cannot determine which direction the conveyor system is moving, and they are more susceptible to electrical noise than other types of encoders. See the topic [I/O Cable on page 26](#) for details on the I/O cable.
- *Single-ended* dual-channel encoders use one wire each for signals A and B. Be aware single-ended encoders are still susceptible to electrical noise.
- *Differential* dual-channel encoders use two lines each for signals A and B. Differential encoders greatly reduce susceptibility to electrical noise.

Single-ended Encoder

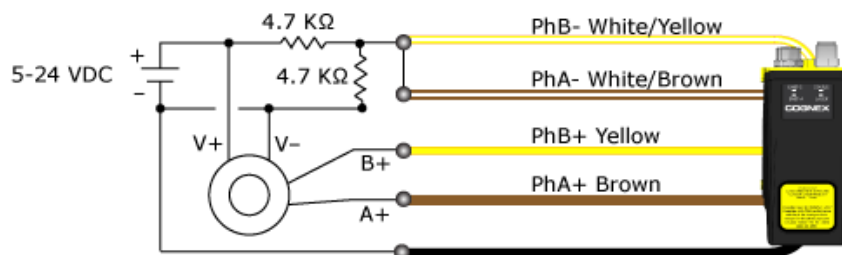

Connect PhA+ and PhB+ to the encoder outputs. Derive PhA- and PhB- from the encoder voltage source and make them equal to 50% of the encoder reference voltage. For example, if the encoder is connected to 24V, set PhA- and PhB- to 12V.

Differential Encoder

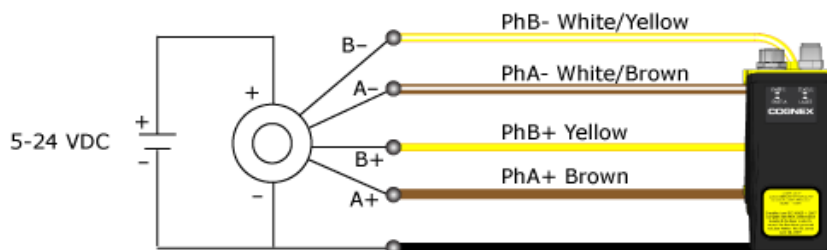

Acquisition Trigger

The acquisition trigger input to the sensor is opto-isolated, and the sensor will respond to a trigger event when the voltage difference between the Trig+ and Trig- inputs exceeds 10V.

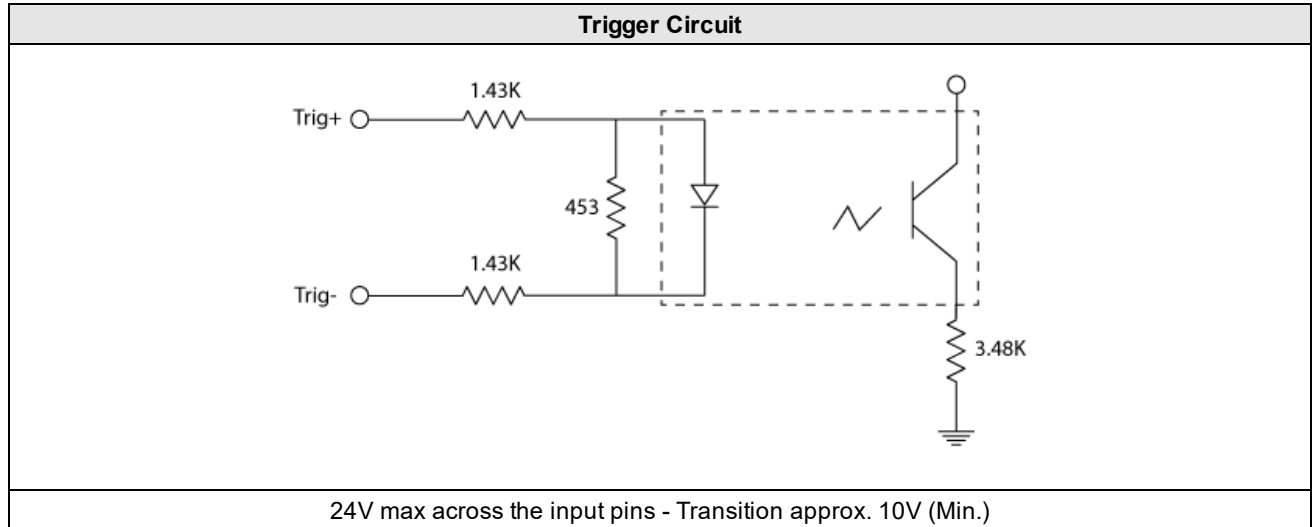

To configure the acquisition trigger as a sourcing input, connect the Trig+ terminal to the high-voltage reference (24 VDC) and the Trig- terminal to the output of the photo-electric sensor.

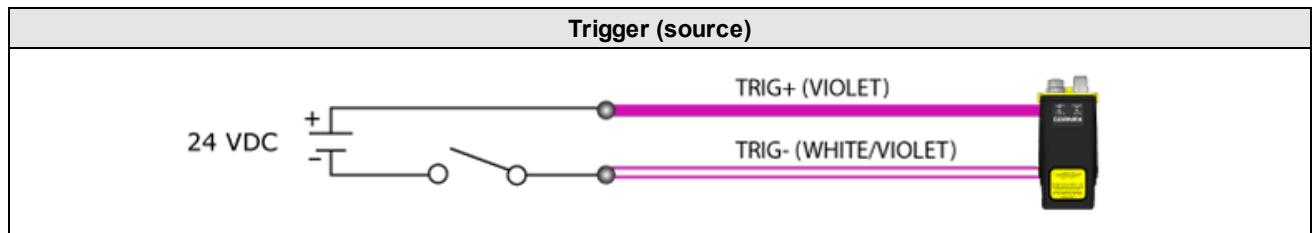

To configure the acquisition trigger as a sinking input, connect the Trig- terminal to the low voltage reference (ground) and the Trig+ terminal to the output of the photo-detector or PLC.

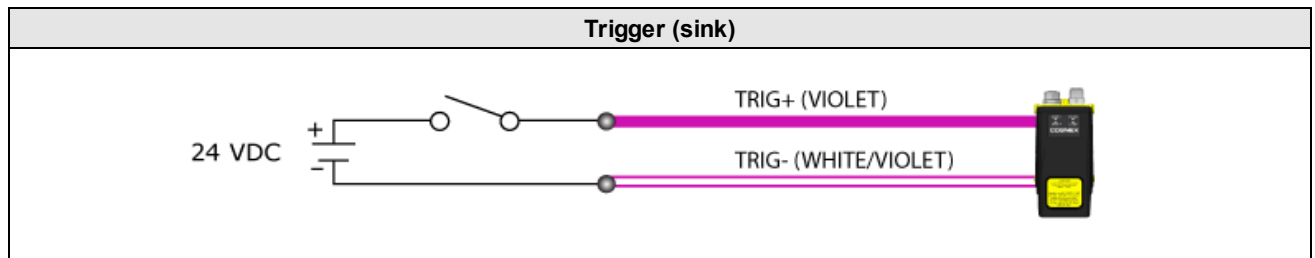

Acquisition Parameters

A DS1000 sensor typically uses a rotary encoder attached to the conveyor system in the process of generating 2D synthetic images containing height profile information for objects under inspection.

Configuring your Cognex vision software to generate images with the best size and resolution requires several parameters that you must specify.

Encoder Resolution and Steps Per Line

Each encoder cycle consists of four rising or falling pulse edges between the two channels, as shown:

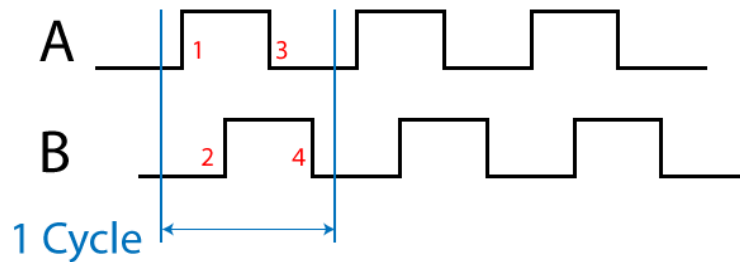

The vision software divides each cycle into *steps*, and allows you to specify the number of steps that must be detected for the sensor to acquire each row of the total image.

By default, one cycle is one step. For many vision applications, this default value allows too much of the object to pass by the sensor, potentially missing important features.

Your Cognex software allows you to increase the number of steps within a single cycle. Basing a step on the rising and falling edge of a pulse from one channel effectively doubles the number of steps per cycle, while basing it after each rising and falling edge of both channels will quadruple the number of steps per cycle.

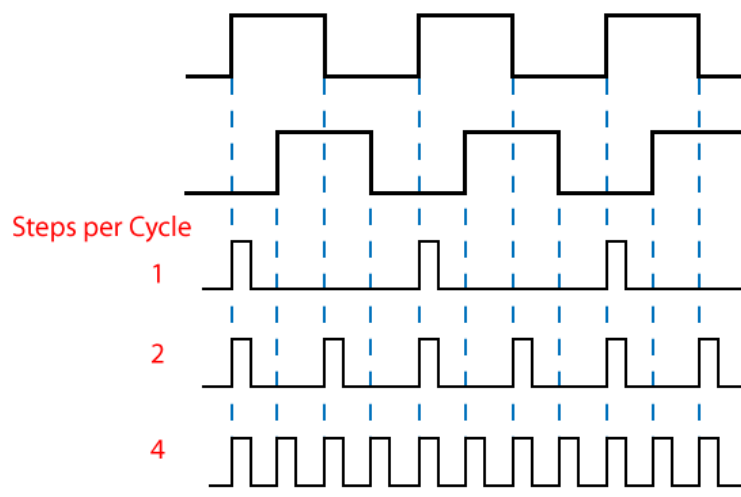

Cognex recommends using an encoder resolution of 4 to ensure your application has the highest possibility of capturing the necessary details of your objects under inspection.

Choosing the best value for the number of steps per line for your acquired images can be an iterative process. If you configure a value that is too low, the sensor acquires too much data and the resulting image will appear stretched:

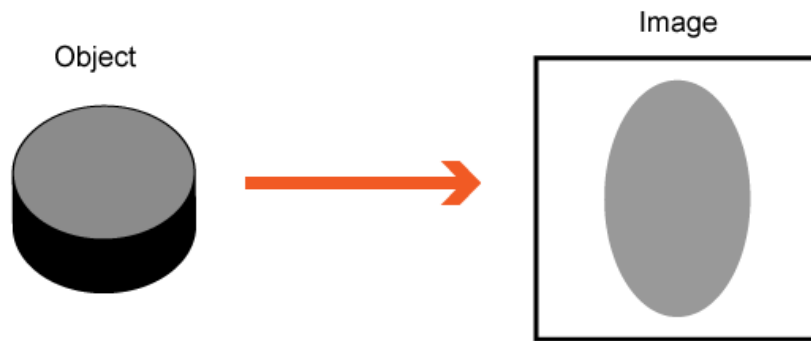

If you specify a value that is too high, the sensor does not acquire enough image information and the resulting image will appear flattened:

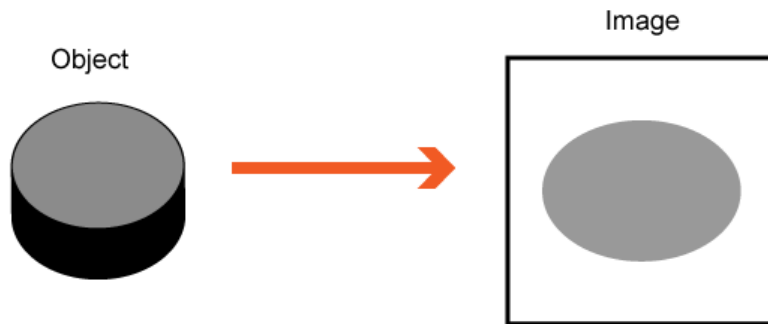

Cognex recommends you experiment with this value for the best results.

Acquisition Wizard

Your Cognex software provides the Displacement Sensor Acquisition Wizard to assist you in configuring the necessary acquisition parameters for your 3D displacement sensor.

The following figure shows one part of the wizard:

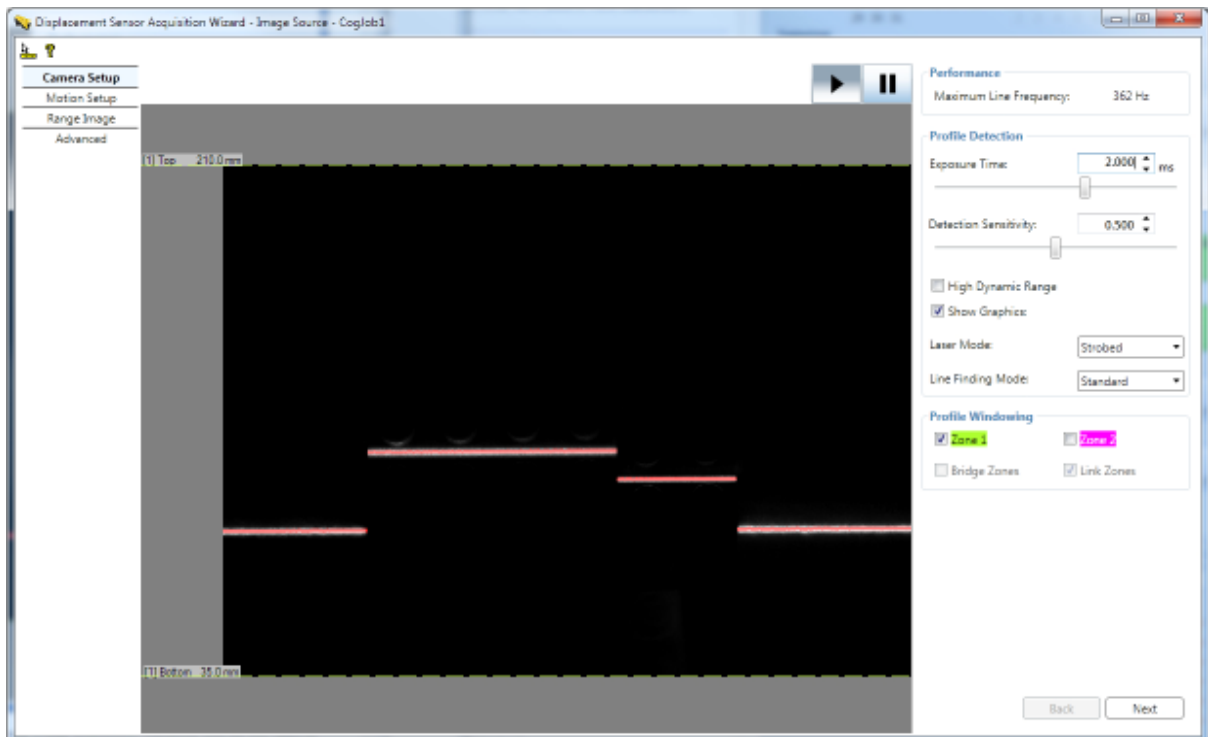

See your Cognex software documentation for details.

Working Section

The *working section* is the subset of the overall laser plane visible to the camera field of view.

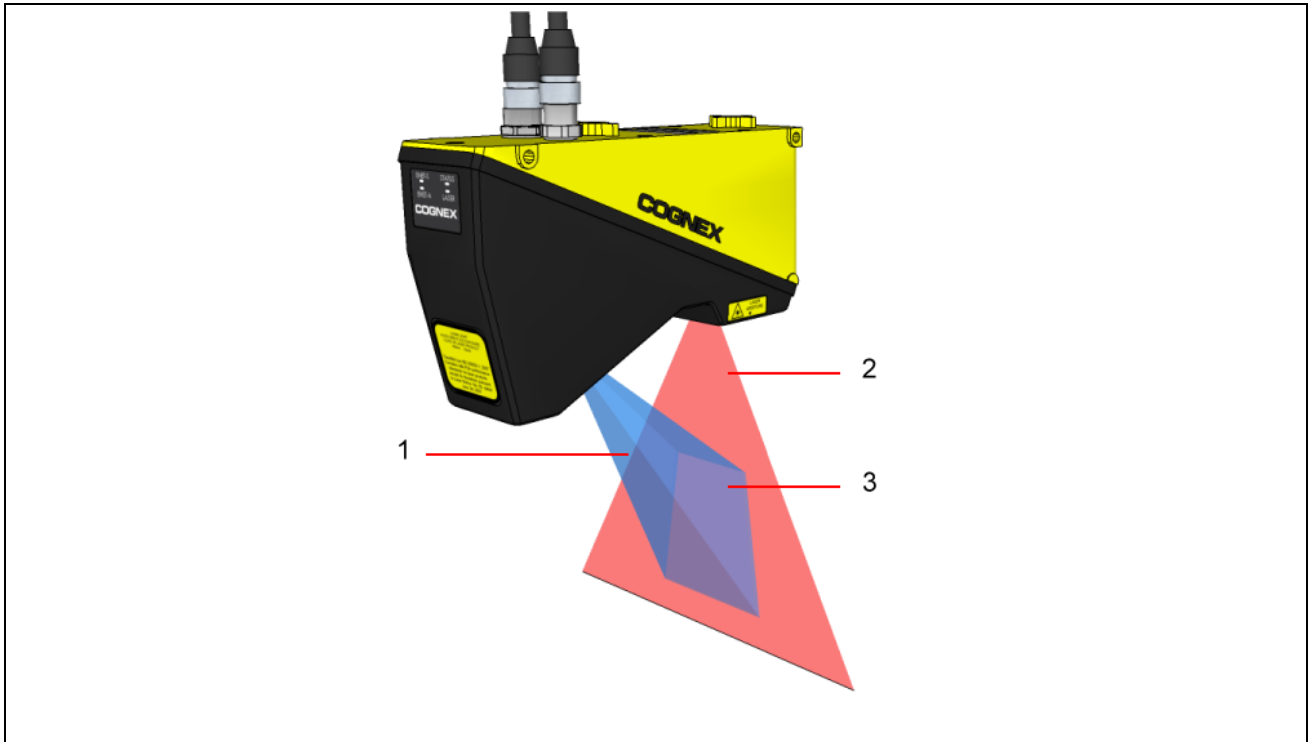

Area	Description
1	Camera field of view
2	Laser
3	Working Section

Each DS1000 series sensor supports a different field of view and working section.

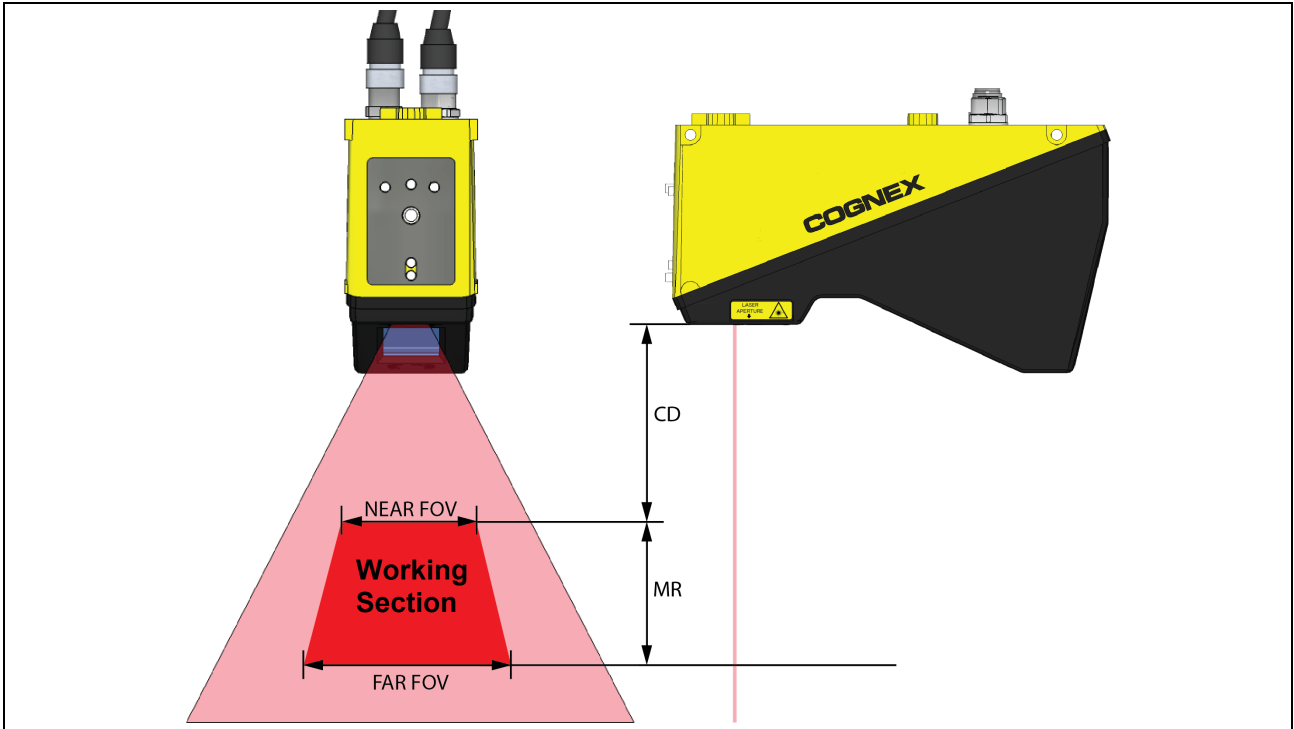

Specification	Model Numbers		
	DS1050	DS1101	DS1300
Clearance Distance (mm)	87	136	181
Near Field of View (mm)	43	64	90
Far Field of View (mm)	79	162	410
Measurement Range (mm)	76	220	725

Range Images

Note: Only DS1000 series sensors acquire range images capable of being analyzed by Cognex 3D vision tools. Some of the content in this section may not apply to the profile images acquired by the DL1000 series sensors.

A range image is a 16-bit greyscale image containing height profile information in real-world coordinates. A range image can be viewed on a typical 2D display or the Cognex 3D Viewer application:

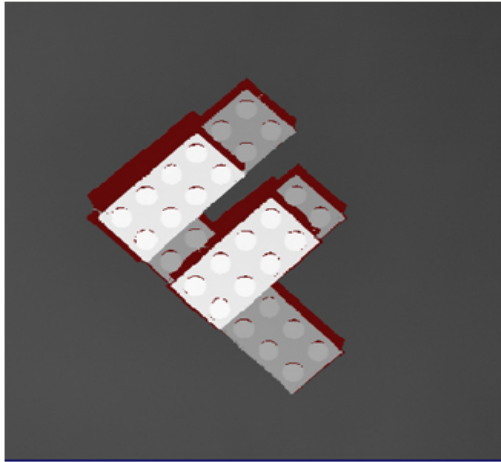

Range image on 2D Display

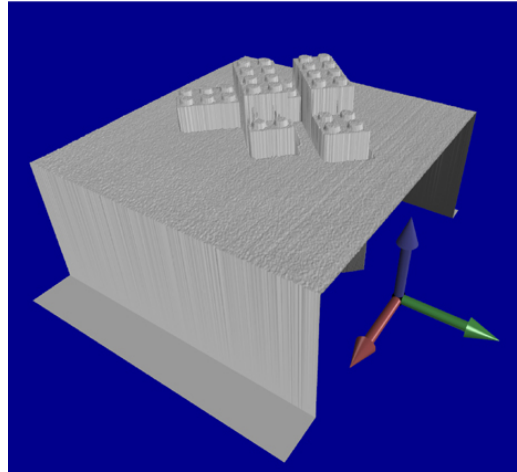

Range Image on 3D Viewer

Your Cognex software generates the range image from a series of acquired intensity images.

Intensity Images

To create an intensity image, the sensor first projects a triangular laser plane onto the object under inspection, creating a laser stripe whose shape is determined by the height of the object features.

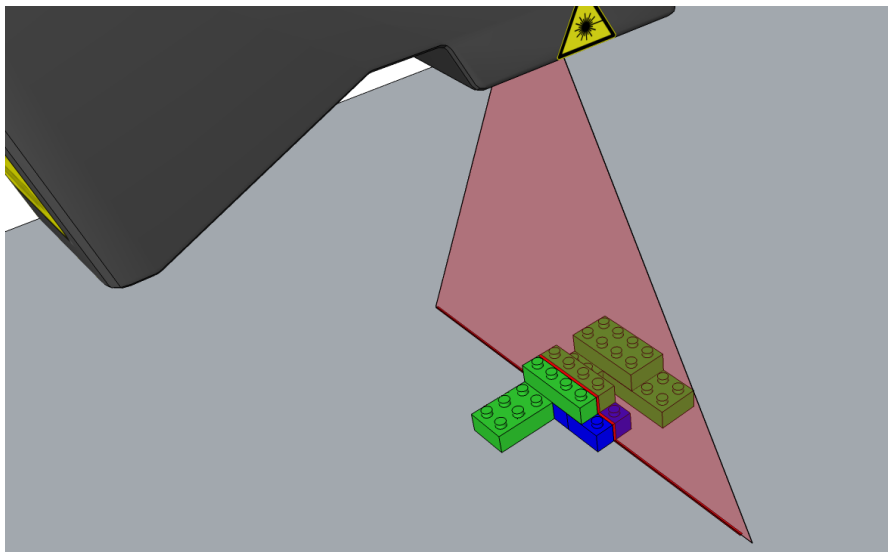

The following figure illustrates the laser stripe as seen from the position of the camera and the intensity image the camera captures:

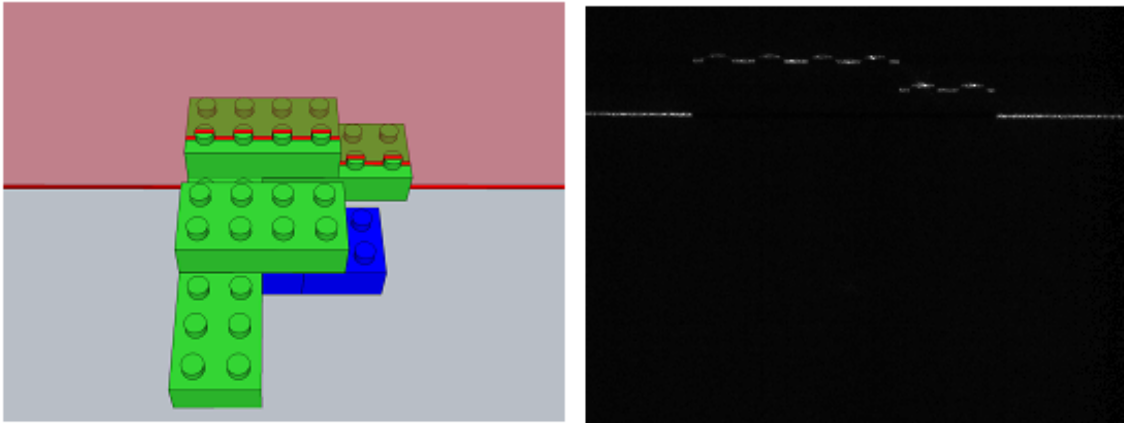

The sensor locates the brightest pixels in the intensity image in order to extract peak information. Your Cognex software combines successive intensity images to generate a synthetic image containing height profile information.

Profile Window

Your Cognex software allows you to define a profile window to limit the working section to a specific zone. For example, the following figure shows one working section with no profile window and another with a profile window to limit where features of interest are expected:

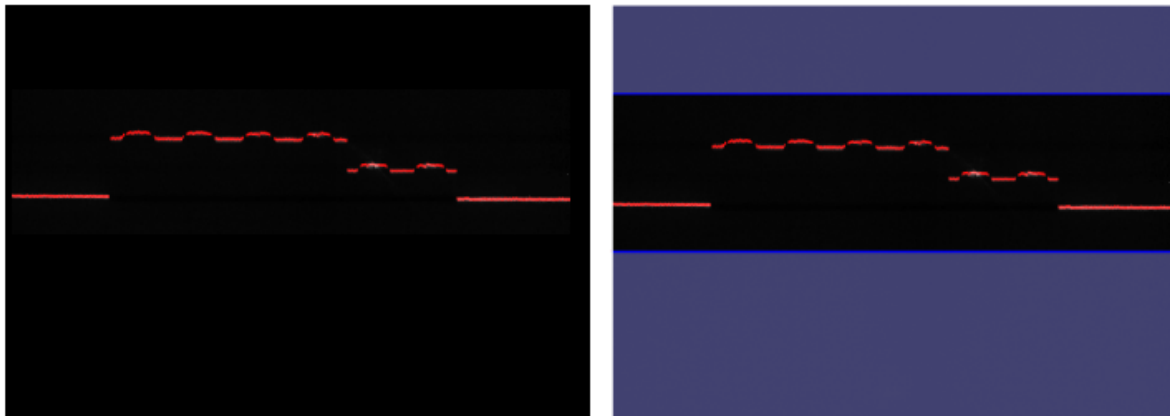

Working Section

Working Section with Profile Window

Using a profile window configures the sensor to ignore any data outside the defined zone, which allows the application to generate a synthetic 3D image faster and gives you the ability to increase the line speed of your vision solution.

While many vision applications use at least one profile window to limit where the sensor searches for peak data information, you can define two separate zones for each image. Use multiple zones when your application can ignore height data from the middle of the object.

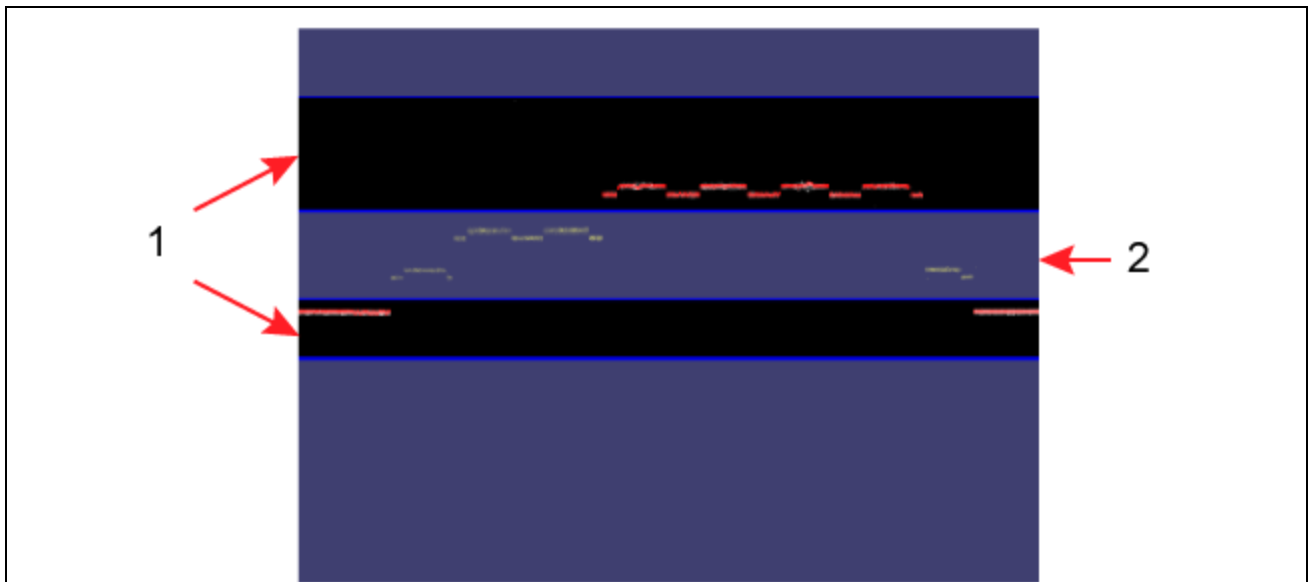

Feature	Description
1	Regions where the software searches for peak data.
2	A gap in the region where the software ignores peak data.

Missing Pixels

Based on the shape of the object and because the camera in the sensor views it at angle from the laser plane, some areas will be hidden from view. By default, any hidden areas are given a missing pixel value of 0 in the range image and are displayed in red within a standard 2D display.

For example, the following figure shows an object being scanned by a sensor:

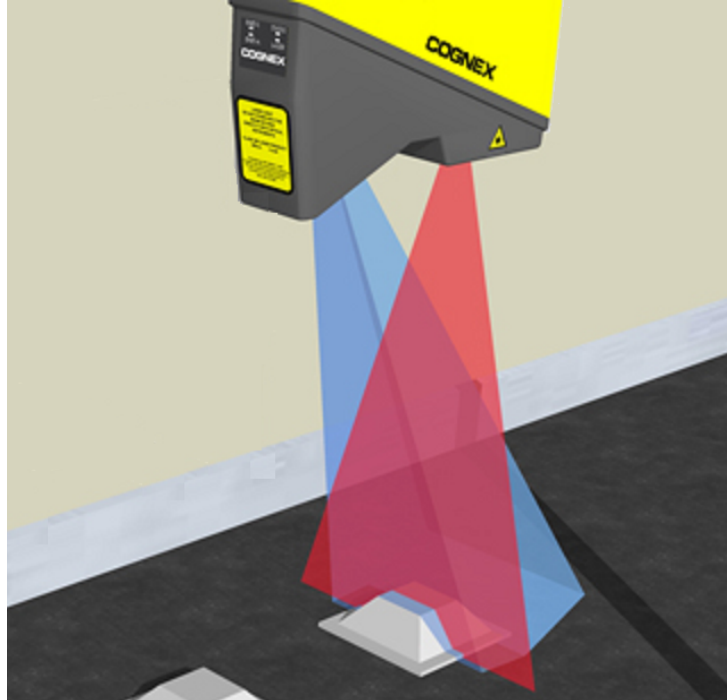

The following figure shows the range image on 2D display with the missing pixels in red:



Missing pixels lack valid values on height profile information for your object, but your Cognex software provides a Missing Pixel operator to replace missing pixels by estimated or interpolated values.

Color Maps

Your Cognex software allows you to modify the default 2D display of range images based on the needs of your application. You can choose to display images:

- Within a limited set of grey values
- To an industry standard for height information
- With values specific to your vision solution

Use a *color map* to change the 2D display of range images. For example, the following figure shows a typical range image and the same image using a color map to display higher data in brighter colors:

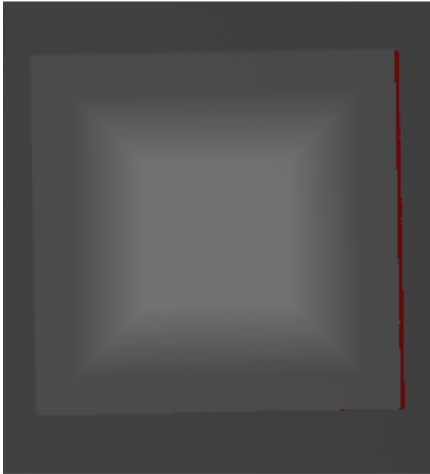

Range Image

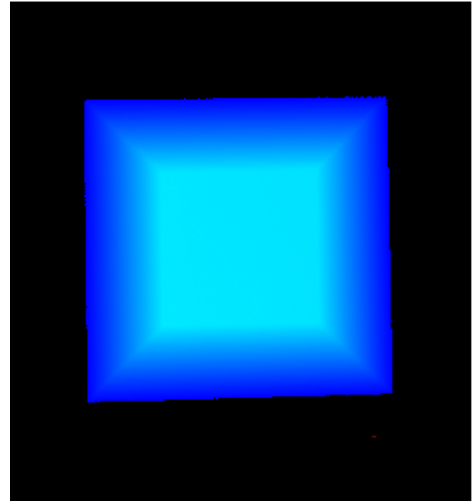

Range Image with Color Map

The values used by a color map are for display purposes and do not change the range image data. See your Cognex software documentation for details.

Calibration

In order to generate a range image which closely represents the physical contours of an object, the sensor must transform raw peak data into real-world coordinates as well as remove the distortion from the camera lens. In addition, the sensor must compensate for perspective distortion, which is illustrated in the following figure:

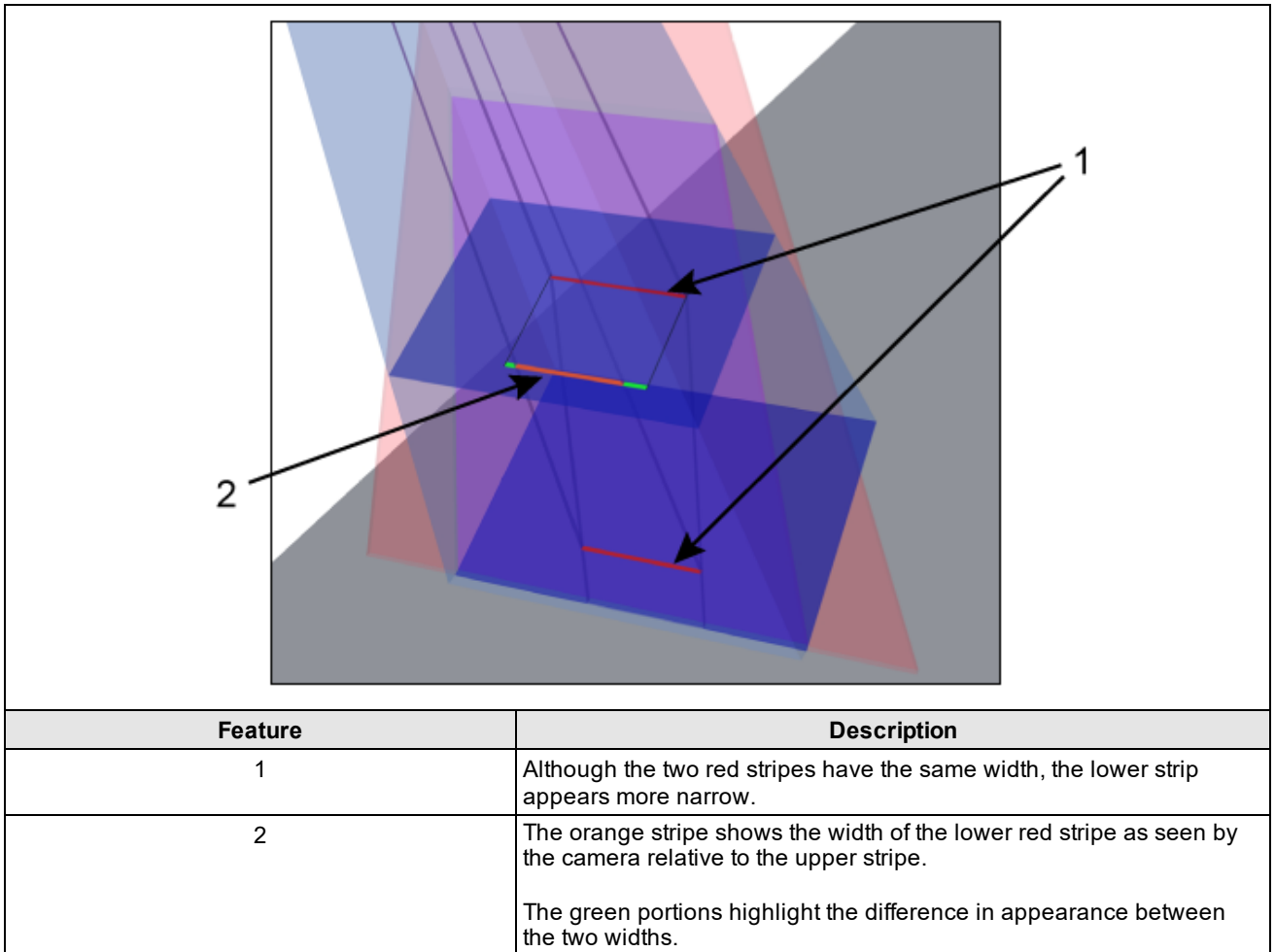

Factory calibration removes any distortion in the calibrated image.

3D Viewer

Your Cognex software provides a 3D Range Image Viewer to view range images in a three-dimensional setting.

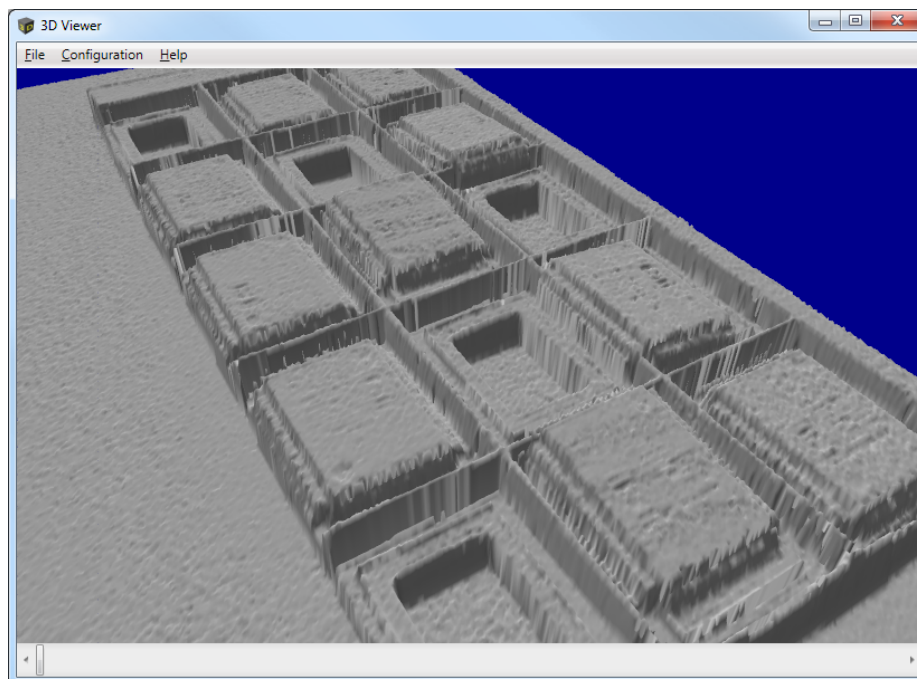

The utility allows you to rotate your view of the image around three-dimensional space. See your Cognex software documentation for more information.

Coordinate Systems

Your Cognex vision software defines two coordinate systems in connection with displacement sensors:

Coordinate System	Description
Sensor 3D Space	Physically accurate / right-handed 3D coordinate system rigidly affixed to the sensor. Units: mm
Image 3D Space	Left-handed, the origin is at the upper-left corner of first pixel in image. Units: pixels (X/Y) pixel values (Z)

Sensor 3D Space

The Sensor 3D coordinate system is defined by:

- The laser plane (X and Y axes)
- The extrapolated position of the mounting pins on the sensor hardware:

The projected laser plane defines the X-axis, while the Y-axis is perpendicular to the X-axis:

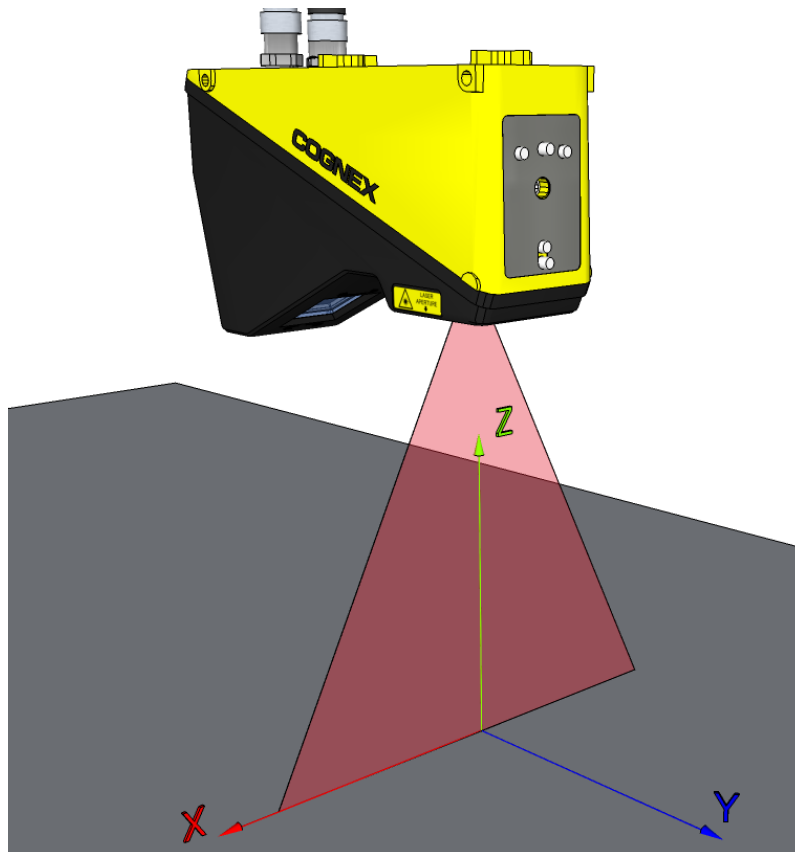
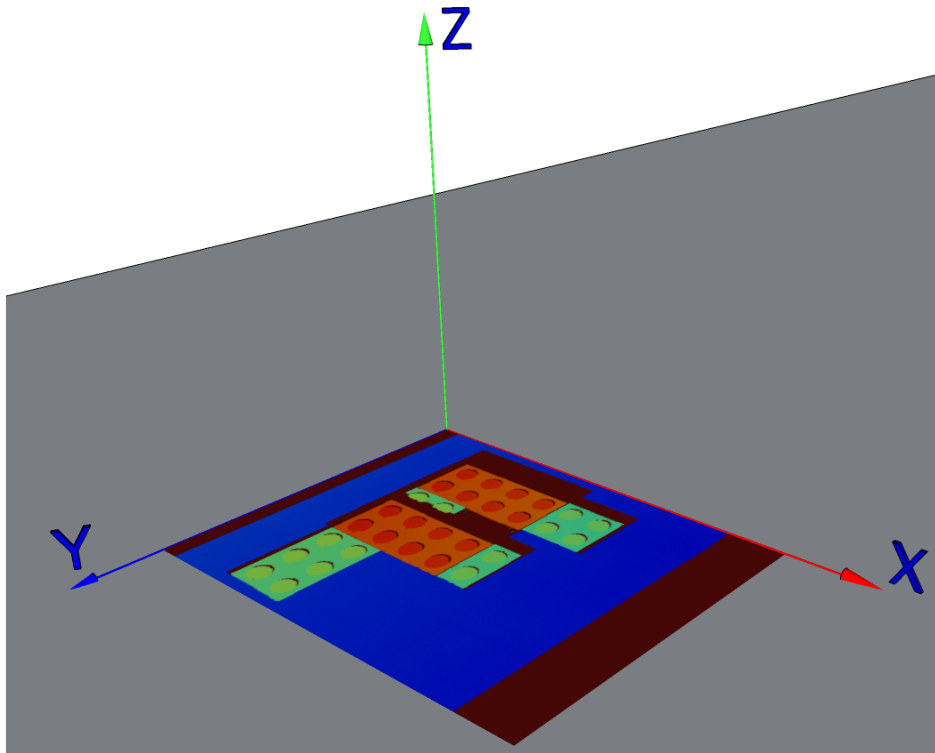

Image 3D Space

Each range image uses a coordinate system defined in Image 3D Space, with units defined in pixel values. The Z-axis contains height information:



Transformation from Image 3D to Sensor 3D Space

A pixel location (X,Y) and height value (Z) in the Image 3D Space of the range image corresponds to a real physical point in the Sensor 3D Space.

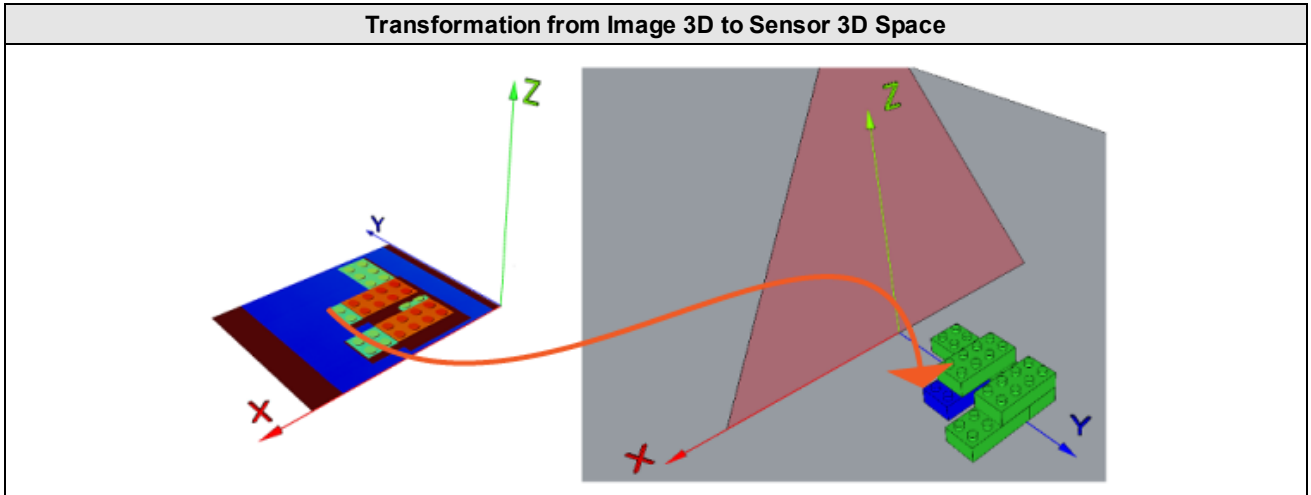

Your Cognex vision software performs the mapping between coordinate spaces.

Motion Direction

The motion direction of your conveyor system changes the origin of the Sensor 3D coordinate system. For example, the following figure shows the origin of both coordinate systems when the direction of motion is lens to laser:

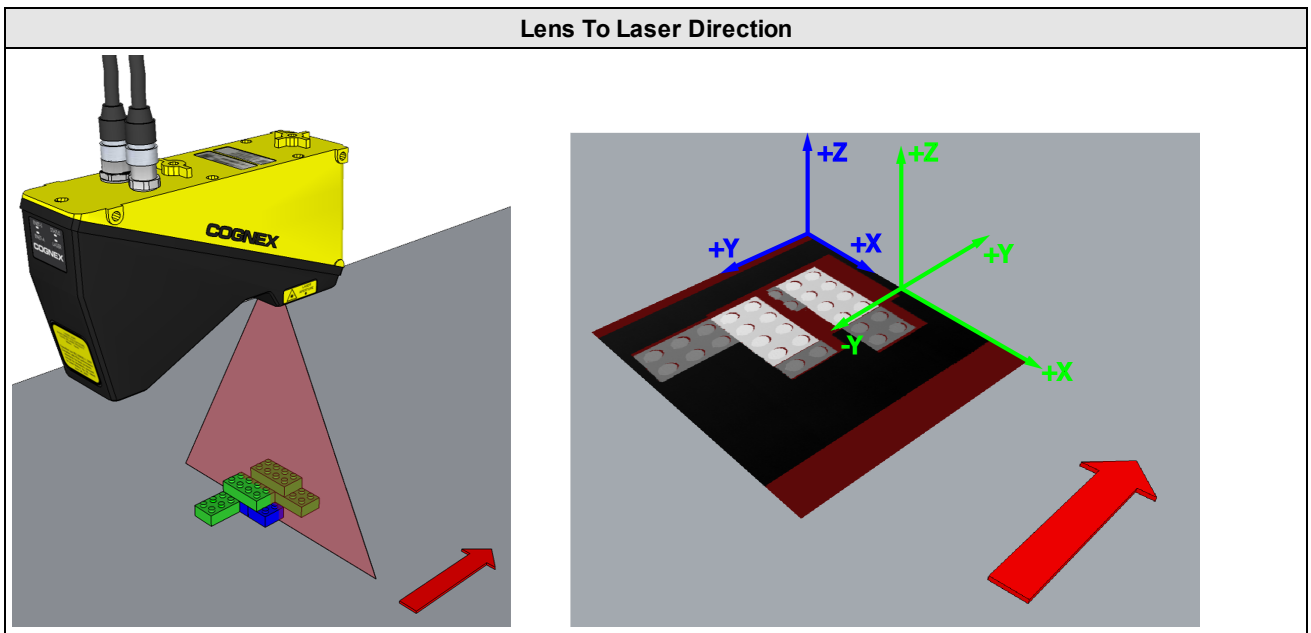

When the direction of motion is laser to lens, the Y-axis points in the opposite direction:

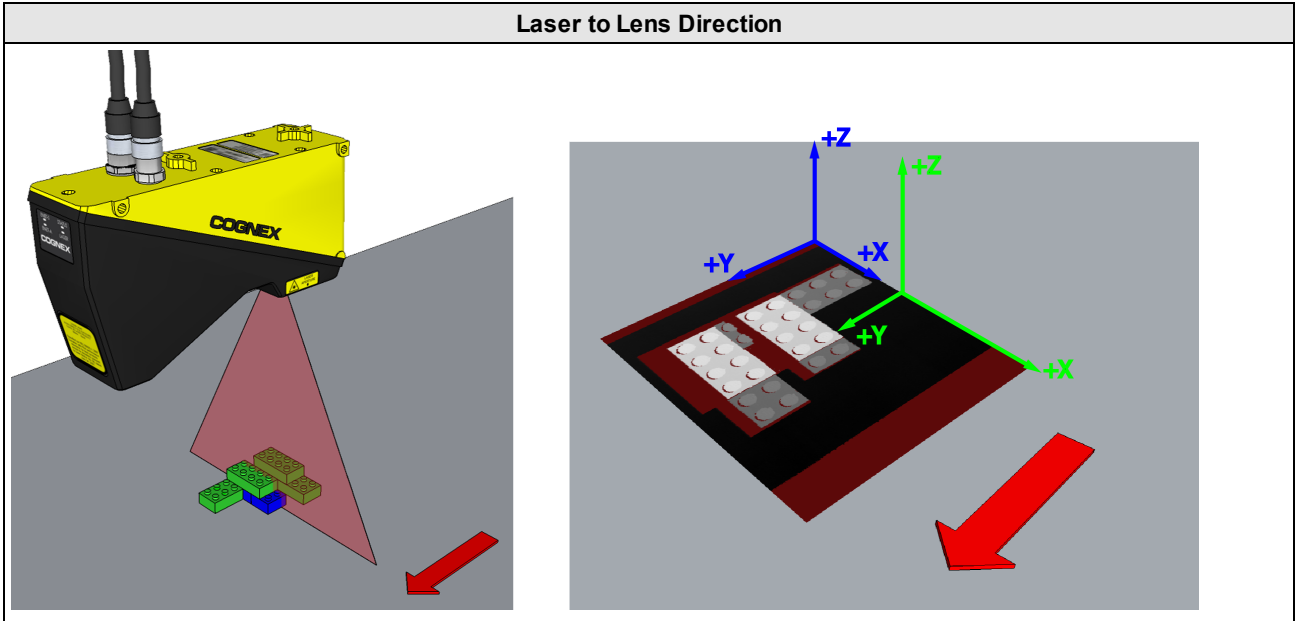

Mirrored Pixels

Be aware that as the same object arrives from opposite directions, the first acquired pixels are made from the other end of the object. As your Cognex software stitches them together in the order of arrival and builds up the image, the result is that the object from one of the two directions looks mirrored.

Here an object arrives in the lens to laser direction and the range image it generates:

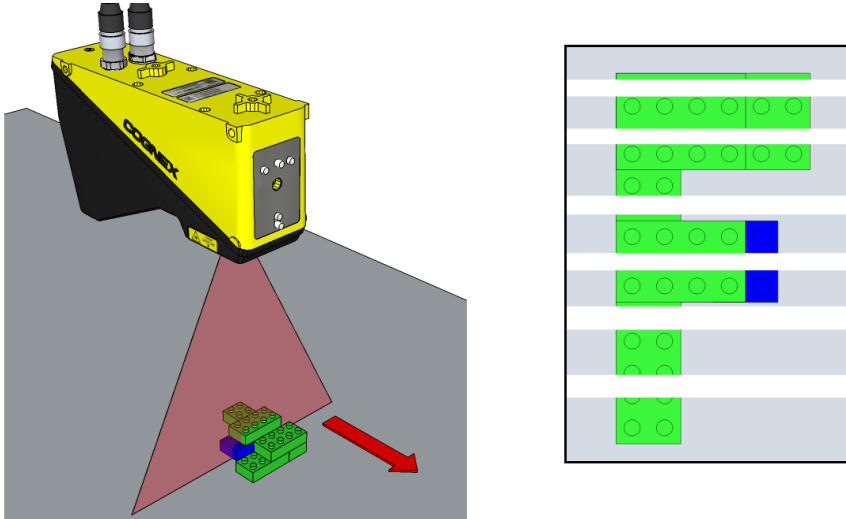

Here an object arrives in the laser to lens direction and its corresponding range image:

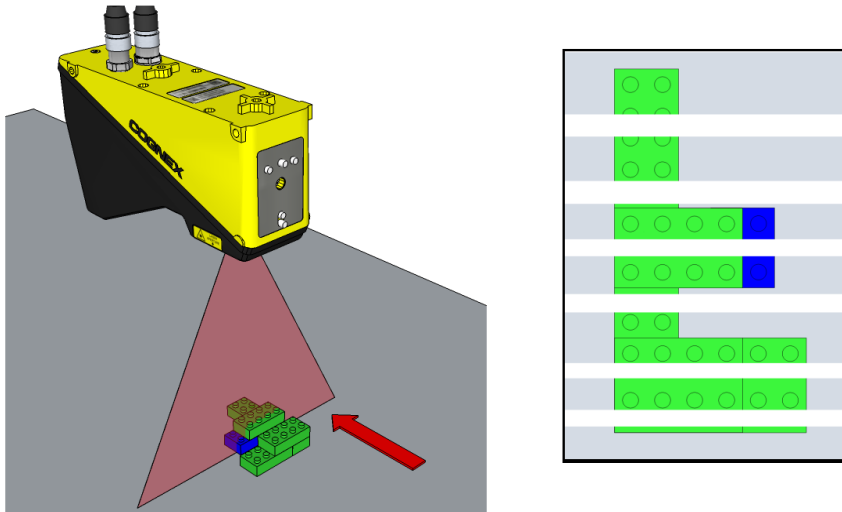

The features of interest in the objects you want to analyze will determine the orientation of the sensor to the direction of motion, although the mirrored range images contain much of the same information about the object.



Compliance Statements

Note: For the most current CE declaration and regulatory conformity information, see the Cognex support site: cognex.com/support.

DS1000 series sensors meet or exceed the requirements of all applicable standards organizations for safe operation. As with any electrical equipment, however, the best way to ensure safe operation is to operate them according to the agency guidelines that follow. Please read these guidelines carefully before using your device.

Regulator	Specification
USA	CFR 47 FCC Part 15 (b) Class A FDA/CDRH Laser Notice No. 50
Canada	ICES-003 Issue 4 Class A
European Community	EN 55022:2006/A1:2007 Class A EN 61000-6-2:2005
Australia	C-TICK, AS/NZS CISPR 22 / EN 55022 for Class A Equipment
Japan	J55022, Class A

Safety and Regulatory

	Regulatory Model 1AAP
	This equipment has been tested and found to comply with the limits for a Class A digital device, pursuant to Part 15 of the FCC rules. These limits are designed to provide reasonable protection against harmful interference when the equipment is operated in a commercial environment. This equipment generates, uses, and can radiate radio frequency energy and, if not installed and used in accordance with the instructions, may cause harmful interference to radio communications. Operation of this equipment in a residential area is likely to cause harmful interference, in which case the user will be required to correct the interference at personal expense.

For European Community Users

Cognex complies with Directive 2012/19/EU OF THE EUROPEAN PARLIAMENT AND OF THE COUNCIL of 4 July 2012 on waste electrical and electronic equipment (WEEE).

This product has required the extraction and use of natural resources for its production. It may contain hazardous substances that could impact health and the environment, if not properly disposed.

In order to avoid the dissemination of those substances in our environment and to diminish the pressure on the natural resources, we encourage you to use the appropriate take-back systems for product disposal. Those systems will reuse or recycle most of the materials of the product you are disposing in a sound way.



The crossed out wheeled bin symbol informs you that the product should not be disposed of along with municipal waste and invites you to use the appropriate separate take-back systems for product disposal.

If you need more information on the collection, reuse, and recycling systems, please contact your local or regional waste administration.

You may also contact your supplier for more information on the environmental performance of this product.

Laser Safety Statement - DS1050



Compliance with FDA performance standards for laser products except for deviations pursuant to Laser Notice No. 50, dated June 24, 2007.

This device has been tested in accordance with IEC60825-1 2nd ed., and has been certified to be under the limits of a Class 2M Laser device.

Use of controls or adjustments or performance of procedures other than those specified herein may result in hazardous radiation exposure.



CAN/CSA-C22.2 No. 61010-1-04 Part 1, UL STD. No. 61010-1, 2nd Edition.

DS1050

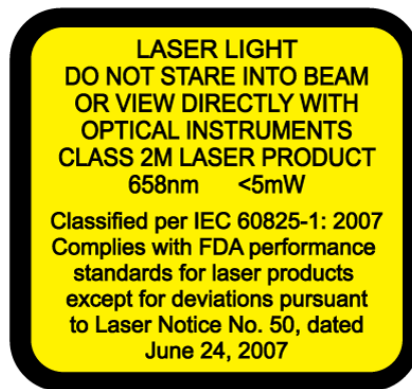

Laser Safety Statement - DS1101



Compliance with FDA performance standards for laser products except for deviations pursuant to Laser Notice No. 50, dated June 24, 2007.

This device has been tested in accordance with IEC60825-1 2nd ed., and has been certified to be under the limits of a Class 2M Laser device.

Use of controls or adjustments or performance of procedures other than those specified herein may result in hazardous radiation exposure.



CAN/CSA-C22.2 No. 61010-1-04 Part 1, UL STD. No. 61010-1, 2nd Edition.



Laser Safety Statement - DS1300



Compliance with FDA performance standards for laser products except for deviations pursuant to Laser Notice No. 50, dated June 24, 2007.

This device has been tested in accordance with IEC60825-1 2nd ed., and has been certified to be under the limits of a Class 2M Laser device.

Use of controls or adjustments or performance of procedures other than those specified herein may result in hazardous radiation exposure.



CAN/CSA-C22.2 No. 61010-1-04 Part 1, UL STD. No. 61010-1, 2nd Edition.

