

3D-A5000™ Series Sensors Hardware Reference



95.0

2019 August 24
Revision: 9.5.0.SR1.5

Table of Contents

Table of Contents	2
Legal Notices	3
Symbols	4
Cognex 3D-A5000 Sensors	5
PC Requirements	6
Windows 10 Network Parameters	7
Supported Sensors	8
Operating Conditions	8
Hardware Installation	10
Precautions	10
Deploy the PC and the 3D Sensor	11
LED Indicators	11
Caution Labels	12
I/O Cable	14
Hardware Triggers	14
Discrete Outputs	15
Cleaning and Handling	17
Fan Accessory	18
Regulations/Conformity: 3D-A5000 Sensors	19
For European Community Users	20

Legal Notices

The software described in this document is furnished under license, and may be used or copied only in accordance with the terms of such license and with the inclusion of the copyright notice shown on this page. Neither the software, this document, nor any copies thereof may be provided to, or otherwise made available to, anyone other than the licensee. Title to, and ownership of, this software remains with Cognex Corporation or its licensor. Cognex Corporation assumes no responsibility for the use or reliability of its software on equipment that is not supplied by Cognex Corporation. Cognex Corporation makes no warranties, either express or implied, regarding the described software, its merchantability, non-infringement or its fitness for any particular purpose.

The information in this document is subject to change without notice and should not be construed as a commitment by Cognex Corporation. Cognex Corporation is not responsible for any errors that may be present in either this document or the associated software.

Companies, names, and data used in examples herein are fictitious unless otherwise noted. No part of this document may be reproduced or transmitted in any form or by any means, electronic or mechanical, for any purpose, nor transferred to any other media or language without the written permission of Cognex Corporation.

Copyright © 2018. Cognex Corporation. All Rights Reserved.

Portions of the hardware and software provided by Cognex may be covered by one or more U.S. and foreign patents, as well as pending U.S. and foreign patents listed on the Cognex web site at: cognex.com/patents.

The following are registered trademarks of Cognex Corporation:

Cognex, 2DMAX, Advantage, AlignPlus, Assemblyplus, Check it with Checker, Checker, Cognex Vision for Industry, Cognex VSOC, CVL, DataMan, DisplayInspect, DVT, EasyBuilder, Hotbars, IDMax, In-Sight, Laser Killer, MVS-8000, OmniView, PatFind, PatFlex, PatInspect, PatMax, PatQuick, SensorView, SmartView, SmartAdvisor, SmartLearn, UltraLight, Vision Solutions, VisionPro, VisionView

The following are trademarks of Cognex Corporation:

The Cognex logo, 1DMax, 3D-Locate, 3DMax, BGAll, CheckPoint, Cognex VSoC, CVC-1000, FFD, iLearn, In-Sight (design insignia with cross-hairs), In-Sight 2000, InspectEdge, Inspection Designer, MVS, NotchMax, OCRMax, PatMax RedLine, ProofRead, SmartSync, ProfilePlus, SmartDisplay, SmartSystem, SMD4, VisiFlex, Xpand

Portions copyright © Microsoft Corporation. All rights reserved.

Portions copyright © MadCap Software, Inc. All rights reserved.

Other product and company trademarks identified herein are the trademarks of their respective owners.

Symbols

The following symbols indicate safety precautions and supplemental information:

 **WARNING:** This symbol indicates a hazard that could cause death, serious personal injury or electrical shock.

 **CAUTION:** This symbol indicates a hazard that could result in property damage.

 **Note:** This symbol indicates additional information about a subject.

 **Tip:** This symbol indicates suggestions and shortcuts that might not otherwise be apparent.

Cognex 3D-A5000 Sensors

Cognex 3D-A5000 sensors combine structured light projection and GigE Vision cameras to generate information about three-dimensional objects. The sensor projects a pattern on an area within the field of view of two enclosed cameras:

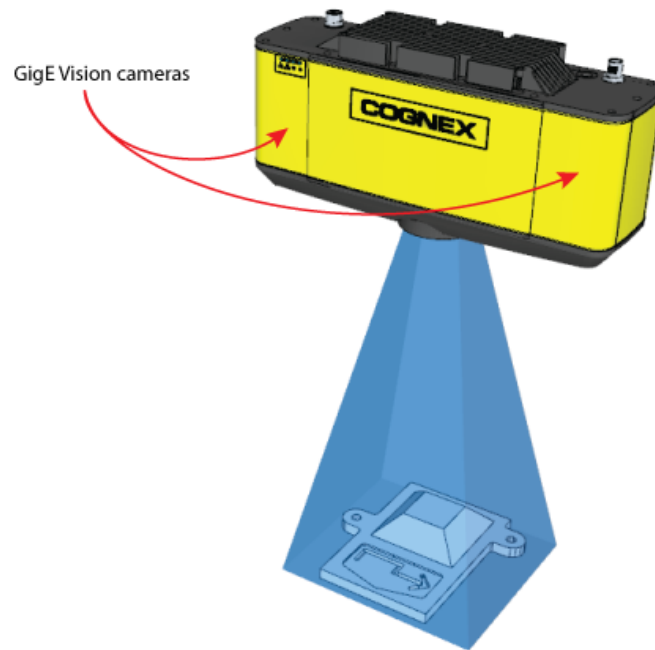

Cognex software builds a 3D data structure representing the object from geometrically distorted images taken from the two cameras, which can then be viewed as a static 2D image or dynamically through a 3D viewing option:

2D Image

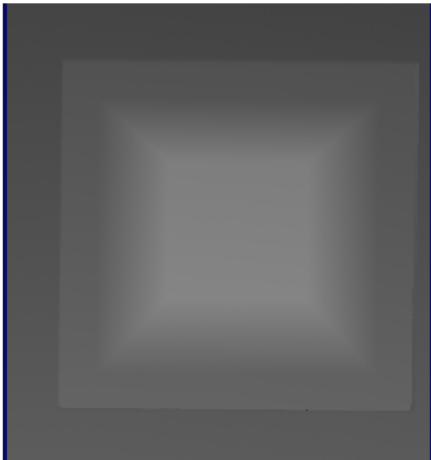

3D Viewer Image

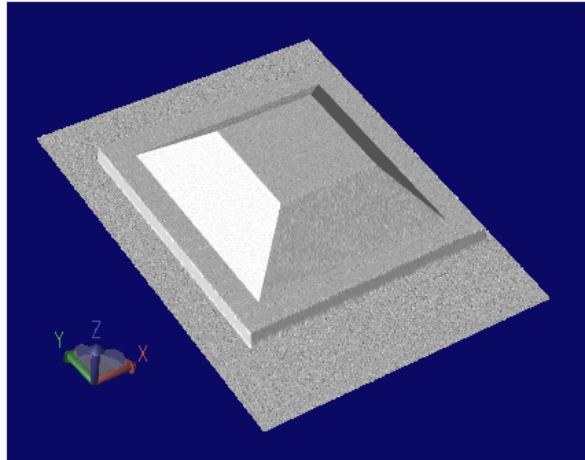

Once you have the 3D data, VisionPro supports a variety of 3D vision tools for performing tasks such as:

- Finding the 3D pose of a trained 3D model
- Generating height or volume calculations
- Analyzing a cross-section of the object

See your installed VisionPro documentation for details.

PC Requirements

Any PC you use with a 3D-A5000 sensor must meet certain minimum requirements. Cognex also makes recommendations for some components.

Components	Requirement
CPU	Minimum: <ul style="list-style-type: none"> 4th generation Intel® Core™ i5 Processor with 4 cores Recommended: <ul style="list-style-type: none"> 8th generation Intel Core i7 Processor with four physical cores (8 logical cores) Intel Xeon E5 Processor with six physical cores (12 logical cores)
Operating System	Windows 10 Pro 64-bit
GPU (mandatory)	Recommended: <ul style="list-style-type: none"> NVIDIA GeForce RTX 2060 NVidia GeForce RTX 2070 NVidia GeForce RTX 2080 NVidia GeForce RTX 2080 Ti
NVIDIA Graphics Driver	Minimum: <ul style="list-style-type: none"> Version 418 Recommended: <ul style="list-style-type: none"> Version 419 or later Download location: https://www.nvidia.com/Download/index.aspx?lang=en-us
10 Gigabit Ethernet Adapters	Chelsio T520-BT Website: https://www.chelsio.com/nic/unified-wire-adapters/t520-bt/ Driver Download: https://service.chelsio.com/downloads/Microsoft/
	Dell QLogic 57810 Dual Port 10Gb Base-T Website: https://www.dell.com/en-us/shop/qlogic-57810-dual-port-10gb-base-t-low-profile-network-adapter/apd/540-bbiu/networking Driver Download: https://www.dell.com/support/home/us/en/04/drivers/driversdetails?driverid=f40v0
	Dell Broadcom NetXtreme II BCM957810A1008G Driver Download: https://www.dell.com/support/home/ie/en/iebsdt1/drivers/driversdetails?driverid=gft61
RAM	Minimum: 8GB Recommended: 16GB
Ethernet Cable	Recommended: Cat6a

Components	Requirement
Power Supply	<p>Required power supply depends on all system components. For typical setups (no additional hardware components [single GPU, single CPU]):</p> <ul style="list-style-type: none"> • 550W power supply for RTX 2060 • 600W power supply for RTX 2070 • 700W power supply for RTX 2080 and RTX 2080 Ti

Windows 10 Network Parameters

The 3D-A5000 requires certain Windows 10 network parameter settings. Perform the following steps to locate the parameters you need to set:

1. Open the Windows 10 **Network and Sharing Center**.
2. Click **Change adapter settings**.
3. Right-click on the network connection corresponding to your 10Gb Ethernet adapter you are using with your 3D-A5000 and choose **Properties**.
4. Under the **Networking** tab, click **Configure**.
5. Click the **Advanced** tab.

Set the following parameters depending on your 10 Gigabit Ethernet adapter:

Adapter	Driver Settings
Chelsio T520-BT	<ul style="list-style-type: none"> • Jumbo packets: 9K • Interrupt moderation: disabled • Max RSS processes: 8 • Max RSS queues: 16 • RX Ethernet queue size: 4096 • RX offload queue size: 2048 • TX Ethernet queue size: 4096 • TX offload queue size: 4096
Dell QLogic 57810 Dual Port 10Gb Base-T	<ul style="list-style-type: none"> • Jumbo packets: 9014 • Interrupt moderation: disabled • Max RSS queues: 16 • Recieve buffers: 3000 • Transmit buffers: 5000 • TX Ethernet queue size: 4096
Dell Broadcom NetXtreme II BCM957810A1008G	<ul style="list-style-type: none"> • Jumbo packets: 9014 • Interrupt moderation: disabled • Max RSS queues: 16 • Recieve buffers: 3000 • Transmit buffers: 5000 • TX Ethernet queue size: 4096

Supported Sensors

Refer to the following table for details on the 3D-A5000 sensors supported by this VisionPro release:

Specification	3D-A5005	3D-A5030	3D-A5060
Resolution	X, Y = 42 - 44 μm	X, Y = 195 - 199 μm	X, Y = 361 - 454 μm
Clearance Distance (mm) The minimum distance required before the sensor will detect 3D features.	300	1465	1400
Near Field of View (mm x mm) The size of the area closest to the sensor where 3D features can be detected. Features above the Near Field of View will not be captured by the sensor.	60 x 44	280 x 210	520 x 390
Measurement Range (mm) The total distance in which the sensor can detect 3D features.	12	80	400
Far Field of View (mm x mm) The size of the area farthest from the sensor where 3D features can be detected. Features below the Far Field of View will not be captured by the sensor.	65 x 46	285 x 215	645 x 490

Refer to the following diagram for physical dimensions of the 3D-A5000 sensor:

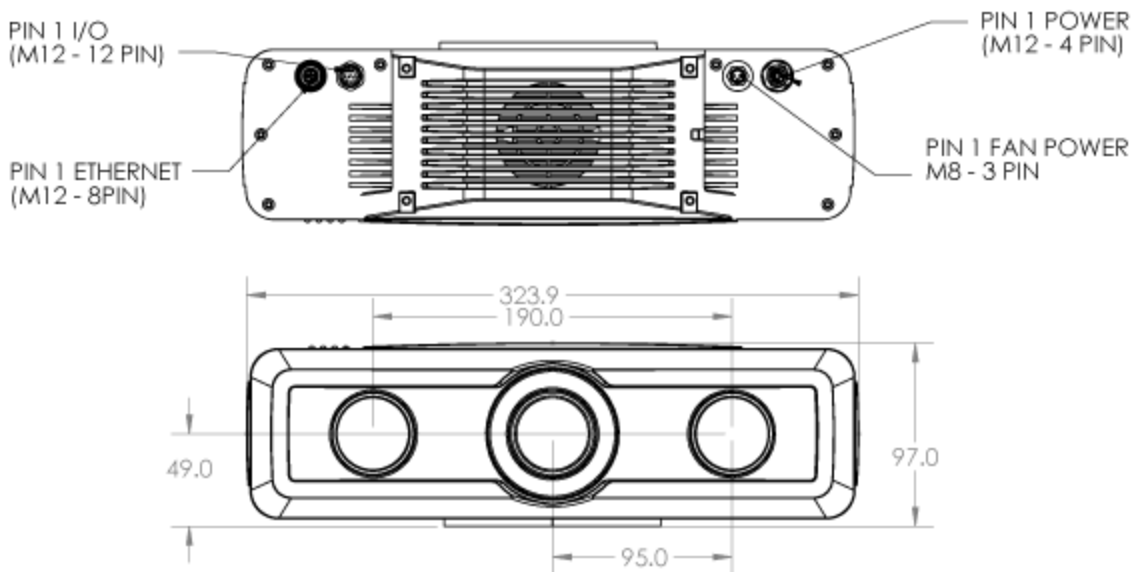

Operating Conditions

Be aware of the general operating conditions of a 3D-A5000 sensor:

Specification	Description	Notes
IP Rating	IP65	

Specification	Description	Notes
Operating temperature range	0 - 40°C	Accurate measurements in trigger mode: 22°C +/- 5°C
Storage Temperature	-10°C to 60°C	
Ambient Temperature	0°C to 40°C	
Power Supply Requirements	+24VDC @ 6.0A (144W) or higher	
Operating Current	Up to 6.0A depending on operation-mode 0,6A with illumination off	
Maximum Humidity	85% non-condensing (maximum)	
Shock (unit in a shipping padded container)	3 Axis, 50 Gs (11ms half-sine pulse)	
Vibration	Non-operating (unit does not acquire images while under vibration): 3 Axis, 4 Gs (10-120Hz for 30 minutes)	
Trigger Inputs	1 opto-isolated acquisition trigger input 4V...24V (High); 0.0V...0.5V (Low) Configurable as current sink (NPN) or current source (PNP)	
Discrete Outputs	3 opto-isolated outputs Configurable as current sink (NPN) or current source (PNP)	

Hardware Installation

Cognex ships your 3D-A5000 sensor with a Cognex security key. Be aware you need the following accessories to complete the installation of your 3D-A5000 series sensor:

- PC
See the section [PC Requirements on page 6](#) for the minimum PC requirements to use with your 3D-A5000 sensor.
- A 1024 x 768 display at 96 DPI
- Power supply and cable
- Power cable to connect to the sensor
- Cat 6a network cables to connect your PC to your corporate network
- (Optional) I/O Cable
- (Optional) Hardware trigger
- A mounting option for your 3D-A5000 sensor.

Refer to the following diagram for physical dimensions (in mm) of the mounting options on the back of the sensor:

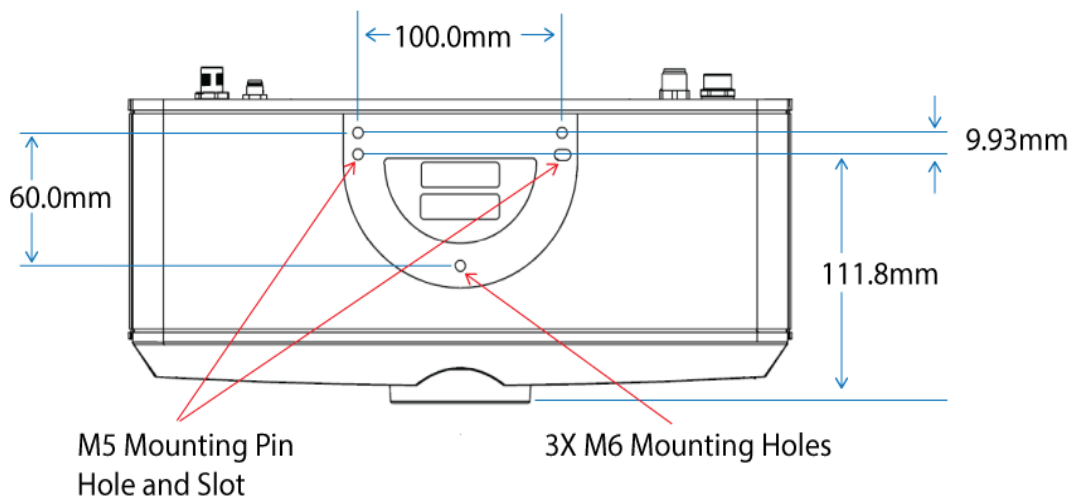

Precautions

To reduce the risk of injury or equipment damage, observe the following precautions when you install the Cognex product:

- Route cables and wires away from high-current wiring or high-voltage power sources to reduce the risk of damage or malfunction from the following causes: over-voltage, line noise, electrostatic discharge (ESD), power surges, or other irregularities in the power supply.
- Changes or modifications not expressly approved by the party responsible for regulatory compliance could void the user's authority to operate the equipment.
- Ensure that the cable bend radius begins at least six inches from the connector. Cable shielding can be degraded or cables can be damaged or wear out faster if a service loop or bend radius is tighter than 10X the cable diameter.
- This device is certified for office use only and if used at home, there can be frequency interference problems.

- This device should be used in accordance with the instructions in this manual. Failure to do so may impair the performance and/or protection provided by the device.
- All specifications are for reference purposes only and can change without notice.

Deploy the PC and the 3D Sensor

Perform the following steps to deploy your PC and 3D-A5000 sensor:

1. Place your PC in a well-ventilated area.
2. Mount your sensor within cable-length of the PC. See [Hardware Installation on page 10](#) for measurements of the mounting plate on the back of the sensor.
3. Connect the GigE cable of the sensor to the 10 Gigabit Ethernet adapter.
4. Connect your 3D-A5000 power cable to a 24V power supply.

Power cable pin assignments:

Pin Number	Signals	Wire Color
1	+24VDC	Red
2	Ground	Black
3	Reserved	
4	Reserved	

5. Connect an optional hardware trigger.

LED Indicators

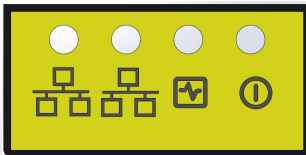

Refer to the following table for a description of the status LED indicators on the front panel of the 3D sensor:

Green (Ethernet)	Yellow (Ethernet)	Red	Green	Details
OFF	OFF	OFF	OFF	Power Off
ON	ON	ON	ON	Powering Up
OFF	OFF	ON	OFF	Booting
OFF	OFF	ON	ON	
ON/OFF	ON (pulses)	OFF	ON (pulses)	System OK Green ON, pulses briefly every 5 seconds Yellow ON if Ethernet link connected at any speed, pulses with Ethernet packets sent or received Green (Ethernet) ON if Ethernet connected at 10 Gbps

Green (Ethernet)	Yellow (Ethernet)	Red	Green	Details
N/A	N/A	FLASH	FLASH	Firmware Update Required Green and Red flash alternately indicating an interrupted firmware update. Sensor will not acquire images until a successful firmware update is complete.
N/A	N/A	ON	FLASH	System Error See the following description.

In the event of a system error, the Green LED fast flashes "N" times, has a long pause, and repeats. The "N" value indicates the error code:

1. File System Corrupt
2. No Calibration File Present
3. Cooling Fan Failure
4. Projector Failure
5. Projector Controller Failure
6. Image Sensor Failure
7. Configuration EEPROM corrupt

If the 3D sensor detects multiple errors, each error is flashed with a pause between each value. For example, for errors 2, 3 and 5 the sequence would be:

- 2 fast flashes and a short pause
- 3 fast flashes and a short pause
- 5 fast flashes and a long pause

Then the cycle would repeat.

Caution Labels

Your 3D-A5000 sensor supports a caution label applied to the side of the sensor:

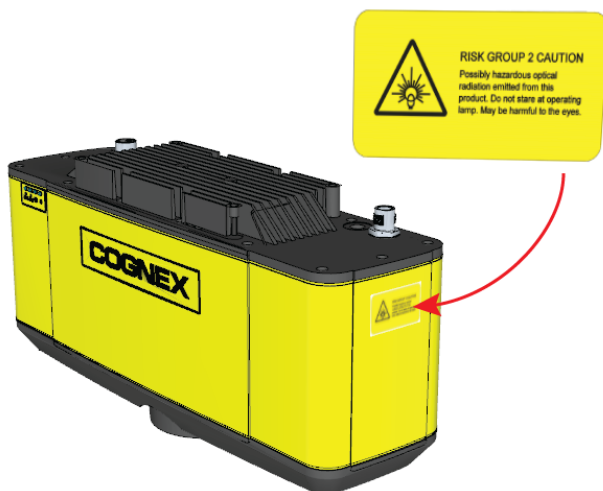

The label contains the following caution:

⚠ CAUTION: Do not stare into operating projector. The intense light may be harmful to the eyes.

Depending on how you mount the hardware in your production environment, the caution label might not be visible to anyone operating the sensor. Find additional English and non-English labels in the packaging with your Cognex hardware.

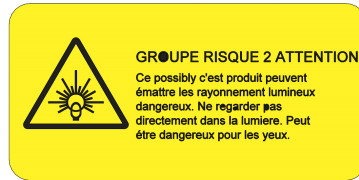
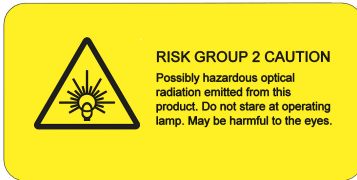

Use the non English label if the English label is not sufficient for your production environment. Place one or both labels in a place visible to anyone operating the sensor:



I/O Cable

The following table describes the 3D-A5000 I/O cable:

Pin Number	Signal	Wire Color
1	READY+	Yellow
2	Reserved	White/Yellow
3	Reserved	Brown
4	READY-	White/Brown
5	TRIGGER_IN+	Violet
6	TRIGGER_IN-	White/Violet
7	Reserved	Red
8	Reserved	Black
9	TRIGGER_OUT+	Green
10	TRIGGER_OUT-	Orange
11	MISSED_TRIGGER+	Blue
12	MISSED_TRIGGER-	Grey

Hardware Triggers

The acquisition trigger input to the 3D sensor is opto-isolated, and the sensor will respond to a trigger event when the voltage difference between the TRIGGER+ and TRIGGER- inputs exceeds 10V.

Specification	Description
V_{IH}	$\pm 10 - \pm 28$ V
V_{IL}	$0 - \pm 5$ V
I_{TYPE}	+12 VDC @ 4 mA
	+24 VDC @ 8 mA
Delay	50 μ s maximum latency between leading edge of trigger and start of acquisition. Input pulse should be a minimum of 1ms wide.

Trigger Circuit

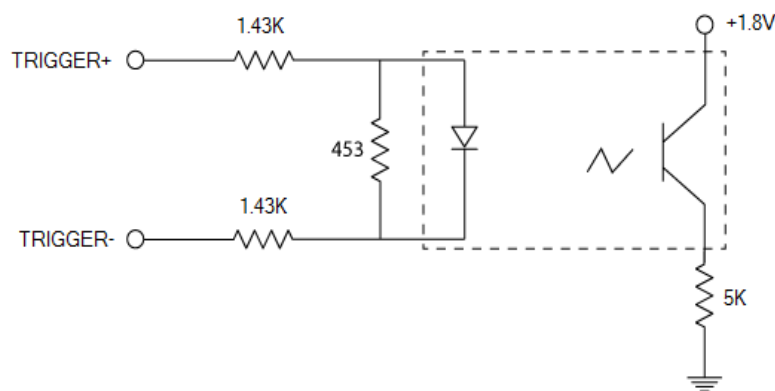

30V max across the input pins - transition approx. 10V (Min.)

To configure the acquisition trigger as a sourcing input, connect the TRIGGER+ terminal to the high-voltage reference (24VDC) and the TRIGGER- terminal to the output of the photo-electric sensor.

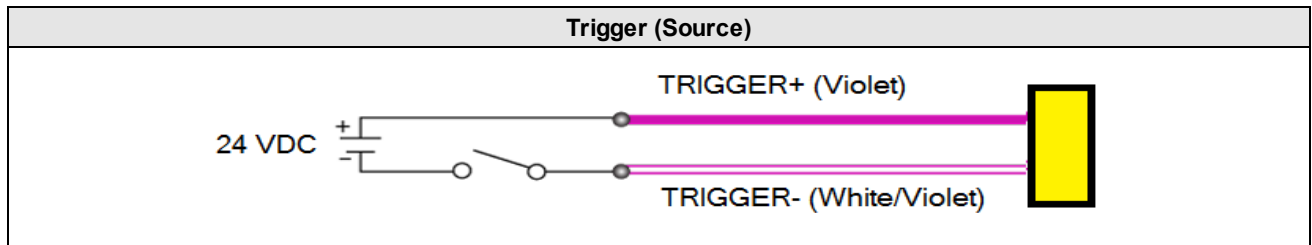

To configure the acquisition trigger as a sinking input, connect the TRIGGER- terminal to the low voltage reference (ground) and the TRIGGER+ terminal to the output of the photo-detector or PLC.

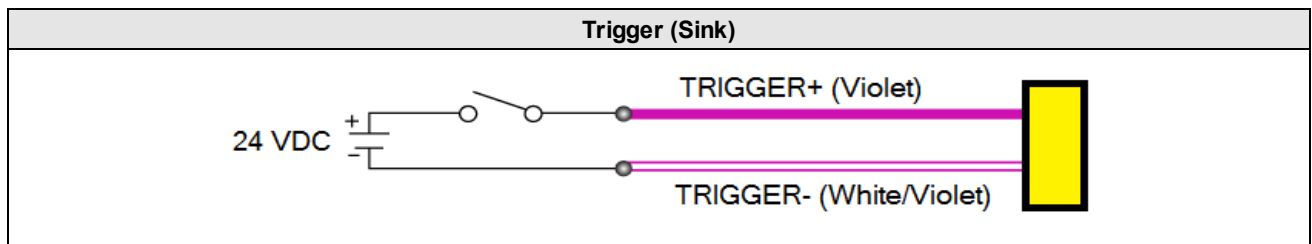

Be aware of the following I/O line behavior during acquisition:

- The sensor asserts the READY line to indicate that it will perform a hardware-triggered acquisition when it detects a rising edge on the TRIGGER_IN line.
The sensor must be configured for hardware triggers, an acquisition start command received, and the sensor must not be currently performing an acquisition.
- The sensor generates a 5.2 ms pulse on the TRIGGER_OUT line at the start of any acquisition sequence (hardware trigger or software trigger)
- The sensor generates a 5.2 ms pulse on the MISSED_TRIGGER line if it detects a TRIGGER_IN signal but the READY line is not asserted

Discrete Outputs

See the topic [Hardware Triggers on page 14](#) for details on the acquisition trigger. Your 3D-A5000 sensor supports three other optically-isolated high-speed outputs that can be used as either NPN (current sinking) or PNP (current sourcing) lines.

Specification	Description
Voltage	+26.4VDC maximum through external load
Current	50mA maximum sink current
	OFF state leakage current 100 μ A
	External load resistance 240 Ohms to 10K Ohms
	Each line rated at a maximum 50mA, protected against over-current, short circuits and transients from switching inductive loads. High current inductive loads require an external protection diode.
Delay ²	10 μ s (maximum due to opto-isolators turning on)

See the topic [I/O Cable on page 14](#) for the pin assignments of the 3D-A5000 sensor I/O cable.

Your 3D-A5000 sensor uses an identical circuit for all the outputs the 3D sensor supports:

- MISSED_TRIGGER
- READY
- TRIGGER_OUT

For example, the following figure contains a block diagram for the MISSED_TRIGGER signal:

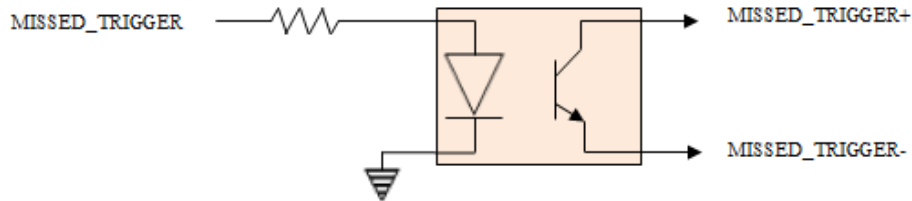

Wiring for sourcing output:

- MISSED_TRIGGER+ to load power (e.g. PLC +24VDC)
- MISSED_TRIGGER- to load (e.g. PLC sinking input) and return (e.g. PLC ground)

Wiring for sinking output:

- MISSED_TRIGGER+ to load (e.g. PLC sourcing input) and power (e.g. +24VDC)
- MISSED_TRIGGER- to load return power (e.g. PLC ground)

Cleaning and Handling

Cognex makes the following recommendations for cleaning your 3D-A5000 sensor.

To clean the outside of the 3D sensor housing, use a small amount of mild detergent cleaner or isopropyl alcohol on a cleaning cloth. Do not pour the cleaner directly onto the 3D sensor housing.

CAUTION: Do not attempt to clean any Cognex product with harsh or corrosive solvents, including lye, methyl ethyl ketone (MEK) or gasoline.

To remove dust from the camera windows, use a pressurized air duster. The air must be free of oil, moisture or other contaminants that could remain on the windows. To clean the window, use a small amount of isopropyl alcohol on a cleaning cloth and gently clean the window surface. Do not scratch the windows. Do not pour the alcohol directly on the windows.

Fan Accessory

The 3D-A5000 supports an optional fan accessory for high-rate acquisition applications:

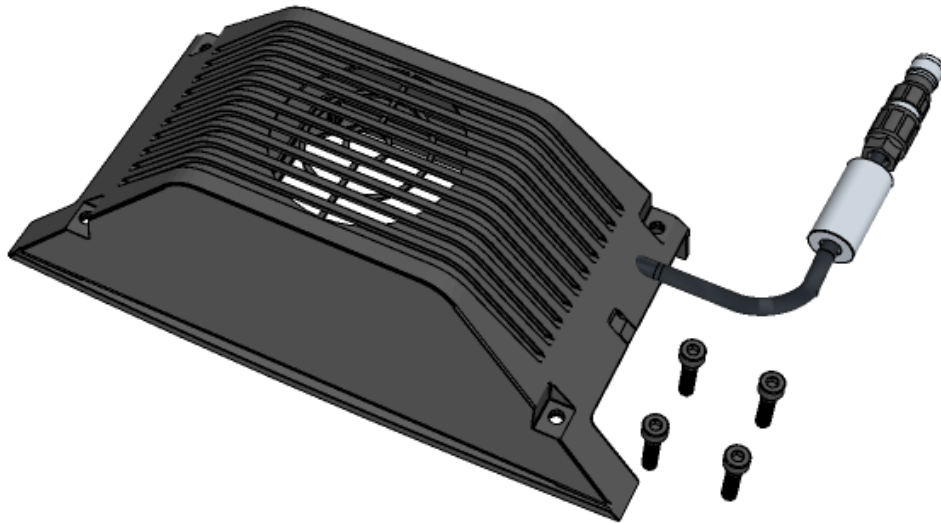





Use the M4 screws to attach the fan to the 3D-A5000 and attach the connector to the socket as shown:



Regulations/Conformity: 3D-A5000 Sensors

Note: For the most current CE declaration and regulatory conformity information, see the Cognex support site: cognex.com/support.

Cognex 3D-A5000 series sensors meet or exceed the requirements of all applicable standards organizations for safe operation. As with any electrical equipment, however, the best way to ensure safe operation is to operate them according to the agency guidelines that follow. Please read these guidelines carefully before using your device.

Safety and Regulatory	
Manufacturer	Cognex Corporation 1 Vision Drive Natick, MA 01760 USA
Canada	ICES-003, Class A
European Community 	<p> CAUTION: This is a class A product. In a domestic environment this product may cause radio interference in which case the user may be required to take adequate measures.</p> <p>This equipment complies with the essential requirements of the EU Directive 2014/30/EU. Declarations are available from your local representative.</p> <p>3D-A5005; Regulatory Model R00094 3D-A5030; Regulatory Model R00095 3D-A5060; Regulatory Model R00092</p>
FCC Class A Compliance Statement 	<p>This equipment has been tested and found to comply with the limits for Class A digital device, pursuant to part 15 of the FCC Rules. These limits are designed to provide reasonable protection against harmful interference when the equipment is operated in a commercial environment.</p> <p>This equipment generates, uses, and can radiate radio frequency energy and, if not installed and used in accordance with the instruction manual, may cause harmful interference to radio communications. Operation of this equipment in a residential area is likely to cause harmful interference in which case the user will be required to correct the interference at his own expense.</p>
KCC 	3D-A5005: Regulatory Model R00094 R-R-CGX-R00094 3D-A5030: Regulatory Model R00095 R-R-CGX-R00095 3D-A5060: Regulatory Model R00092 R-R-CGX-R00092
NRTL	TÜV SÜD AM SCC/NRTL OSHA Scheme for UL/CAN 61010-1
CB	TÜV SÜD AM, IEC/EN 61010-1. CB report available upon request
RoHs	Compliant to the most recent applicable directive

For European Community Users

Cognex complies with Directive 2012/19/EU OF THE EUROPEAN PARLIAMENT AND OF THE COUNCIL of 4 July 2012 on waste electrical and electronic equipment (WEEE).

This product has required the extraction and use of natural resources for its production. It may contain hazardous substances that could impact health and the environment, if not properly disposed.

In order to avoid the dissemination of those substances in our environment and to diminish the pressure on the natural resources, we encourage you to use the appropriate take-back systems for product disposal. Those systems will reuse or recycle most of the materials of the product you are disposing in a sound way.



The crossed out wheeled bin symbol informs you that the product should not be disposed of along with municipal waste and invites you to use the appropriate separate take-back systems for product disposal.

If you need more information on the collection, reuse, and recycling systems, please contact your local or regional waste administration.

You may also contact your supplier for more information on the environmental performance of this product.

