

In-Sight[®] SnAPP Series Reference Manual



2024 February 21
Revision: 23.1.0.7

Legal Notices

The software described in this document is furnished under license, and may be used or copied only in accordance with the terms of such license and with the inclusion of the copyright notice shown on this page. Neither the software, this document, nor any copies thereof may be provided to, or otherwise made available to, anyone other than the licensee. Title to, and ownership of, this software remains with Cognex Corporation or its licensor. Cognex Corporation assumes no responsibility for the use or reliability of its software on equipment that is not supplied by Cognex Corporation. Cognex Corporation makes no warranties, either express or implied, regarding the described software, its merchantability, non-infringement or its fitness for any particular purpose.

The information in this document is subject to change without notice and should not be construed as a commitment by Cognex Corporation. Cognex Corporation is not responsible for any errors that may be present in either this document or the associated software.

Companies, names, and data used in examples herein are fictitious unless otherwise noted. No part of this document may be reproduced or transmitted in any form or by any means, electronic or mechanical, for any purpose, nor transferred to any other media or language without the written permission of Cognex Corporation.

Copyright © 2023. Cognex Corporation. All Rights Reserved.

Portions of the hardware and software provided by Cognex may be covered by one or more U.S. and foreign patents, as well as pending U.S. and foreign patents listed on the Cognex web site at: cognex.com/patents.

The following are registered trademarks of Cognex Corporation:

Cognex, 2DMAX, Advantage, AlignPlus, Assemblyplus, Check it with Checker, Checker, Cognex Vision for Industry, Cognex VSOC, CVL, DataMan, DisplayInspect, DVT, EasyBuilder, Hotbars, IDMax, In-Sight, Laser Killer, MVS-8000, OmniView, PatFind, PatFlex, PatInspect, PatMax, PatQuick, SensorView, SmartView, SmartAdvisor, SmartLearn, UltraLight, Vision Solutions, VisionPro, VisionView

The following are trademarks of Cognex Corporation:

The Cognex logo, 1DMax, 3D-Locate, 3DMax, BGAll, CheckPoint, Cognex VSoC, CVC-1000, FFD, iLearn, In-Sight (design insignia with cross-hairs), In-Sight 2000, InspectEdge, Inspection Designer, MVS, NotchMax, OCRMax, PatMax RedLine, ProofRead, SmartSync, ProfilePlus, SmartDisplay, SmartSystem, SMD4, VisiFlex, Xpand

Portions copyright © Microsoft Corporation. All rights reserved.

Portions copyright © MadCap Software, Inc. All rights reserved.

Other product and company trademarks identified herein are the trademarks of their respective owners.

Precautions

To reduce the risk of injury or equipment damage, observe the following precautions when you install the Cognex product:

- The safety of any system incorporating this product is the responsibility of the assembler of the system.
- Do not install Cognex products where they are exposed to environmental hazards such as excessive heat, dust, moisture, humidity, impact, vibration, corrosive substances, flammable substances, or static electricity.
- Route cables and wires away from high-current wiring or high-voltage power sources to reduce the risk of damage or malfunction from the following causes: over-voltage, line noise, electrostatic discharge (ESD), power surges, or other irregularities in the power supply.
- Do not expose the image sensor to laser light. Image sensors can be damaged by direct, or reflected, laser light. If your application requires laser light that might strike the image sensor, use a lens filter at the corresponding laser wavelength. For suggestions, contact your local integrator or application engineer.
- This product does not contain user-serviceable parts. Do not make electrical or mechanical modifications to product components. Unauthorized modifications can void your warranty.
- Changes or modifications not expressly approved by the party responsible for regulatory compliance could void the user's authority to operate the equipment.
- Include service loops with cable connections.
- Ensure that the cable bend radius begins at least six inches from the connector. Cable shielding can be degraded or cables can be damaged or wear out faster if a service loop or bend radius is tighter than 10X the cable diameter.
- This device should be used in accordance with the instructions in this manual.
- All specifications are for reference purposes only and can change without notice.

Symbols

The following symbols indicate safety precautions and supplemental information:

 **WARNING:** This symbol indicates a hazard that could cause death, serious personal injury or electrical shock.

 **CAUTION:** This symbol indicates a hazard that could result in property damage.

 **Note:** This symbol indicates additional information about a subject.

 **Tip:** This symbol indicates suggestions and shortcuts that might not otherwise be apparent.

Table of Contents

Legal Notices	2
Precautions	3
Symbols	4
Table of Contents	5
Getting Started	7
About the In-Sight SnAPP Series	7
Illumination Options for In-Sight SnAPP	8
Accessories	9
Mounting Brackets	9
Cables	9
Support	9
Setting Up Your In-Sight Vision Sensor	11
Vision Sensor Layout	11
Dimensions	13
In-Sight SnAPP with 16 mm Lens	13
In-Sight SnAPP with 6.2 mm Lens - Right Angle Configuration	14
Field of View and Working Distance	15
In-Sight SnAPP with 6.2 mm Lens	15
In-Sight SnAPP Mini with 16 mm Lens	16
Connecting the Vision Sensor	17
Mounting the Vision Sensor	17
Connecting the Ethernet Cable	21
Connecting the Power and I/O Breakout Cable	22
Indicator LEDs	22
Using Your In-Sight SnAPP Vision Sensor	24
How to Connect to the Vision Sensor	24
Network Settings	24
Factory Reset	25
Trigger Types	27
Industrial Protocols	28
Specifications	29
In-Sight SnAPP Series Vision Sensor	29
In-Sight SnAPP Series Vision Sensor Image Sensor	29
LED and Laser Wavelengths	31
Acquisition Trigger Input	31
High-Speed Outputs	32
High Speed Output Wiring	33
Ethernet Cable	34
Power and I/O Breakout Cable Specifications	34
CCB-PWRIO-05	35
Cleaning and Maintenance	36
Clean the Housing	36

Clean the Vision Sensor Image Sensor Window	36
Clean the Vision Sensor Lens Cover	36
Regulations and Conformity	37
中国大陆 RoHS (Information for China RoHS Compliance)	39
For European Community Users	39

Getting Started

This section provides general information about the In-Sight SnAPP series vision sensor and the accessories and systems.

About the In-Sight SnAPP Series

The In-Sight SnAPP series vision sensors are high-performance, easy hardware and software setup vision sensors that offer:

- Premium class performance in a compact package
- Flexible Industry 4.0 connectivity options
- Unmatched Modularity and Ease of Use
- 1.6 Mp mono color

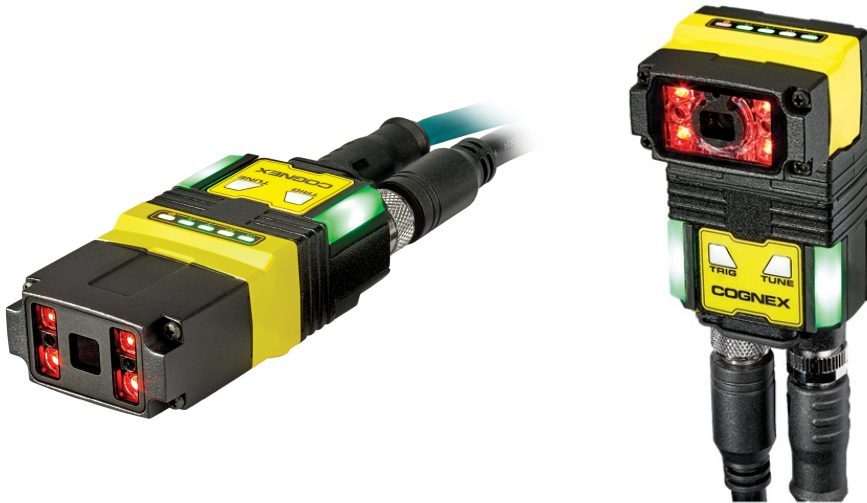

Illumination Options for In-Sight SnAPP

The following illumination options are available for In-Sight SnAPP vision sensors:

- **High Powered Illumination for 16 mm lens:**

High-powered integrated light attachments are available in RED or WHITE color options for In-Sight SnAPP vision sensors using a 16 mm lens.



- **Standard Illumination for 6.2 mm lens:**



Integrated light attachments are available in RED or WHITE options for In-Sight SnAPP vision sensors using a 6.2 mm lens.



Accessories









You can purchase the following components separately. For a list of options and accessories, contact your local Cognex sales representative.

Mounting Brackets

Accessory	Product Number	Illustration
Universal mounting bracket	DM100-UBRK-000	
Pivot mounting bracket	DM100-PIVOTM-01	
Tilted angle pivot bracket	DMBK-DMPIVOT-00	

Cables

Note: Cables are sold separately.

Accessory	Product Number	Illustration
Ethernet Cable, X-coded M12-8 to RJ-45	CCB-84901-2001-xx (straight, xx specifies length: 2m, 5m, 10m, 15m, 30m)	
Ethernet Cable, X-coded M12-8 to RJ-45	CCB-84901-2002-xx (right-angled, xx specifies length: 2m, 5m, 10m)	
Ethernet Cable, Robotic X-Coded M12-8 to RJ-45	CCB-84901-2RBT-xx (straight, xx specifies length: 2m, 5m, 10m)	
X-Coded to A-Coded Ethernet cable adapter, 0.5 m	CCB-M12X8MS-XCAC	
Power and I/O Breakout Cable, M12-12 to Flying Lead	CCB-PWRIO- xx (straight, xx specifies length: 5m, 10m, 15m)	
Power and I/O Breakout Cable, M12-12 to Flying Lead	CCB-PWRIO-xxR (right-angled, xx specifies length: 5m, 10m, 15m)	
I/O Module Cable M12-12 to DB15	CCB-PWRIO-MOD-xx (xx specifies length: 2m, 5m)	
RS-232 Connection Cable	CCB-M12xDB9Y-05	
I/O Extension Cable	CKR-200-CBL-EXT	

Support

Many resources are available to help you use the vision sensor:

-
- For extended software help, please see the *Software Guide*, available on the device.
 - For training videos and additional resources, please visit the SnAPP landing page: cognex.com/in-sight-snapp-support.

 **Note:** For the latest documentation, visit: support.cognex.com/documentation/in-sight.

Setting Up Your In-Sight Vision Sensor

Read this section to learn how the vision sensor connects to its standard components and accessories.

Note:



- Cables are sold separately.
- If a standard component is missing or damaged, immediately contact your Cognex Authorized Service Provider (ASP) or Cognex Technical Support.



CAUTION: All cable connectors are keyed to fit the connectors on the vision sensor. Do not force the connections or damage may occur.

Vision Sensor Layout

The image and table below shows the elements of the vision sensor.

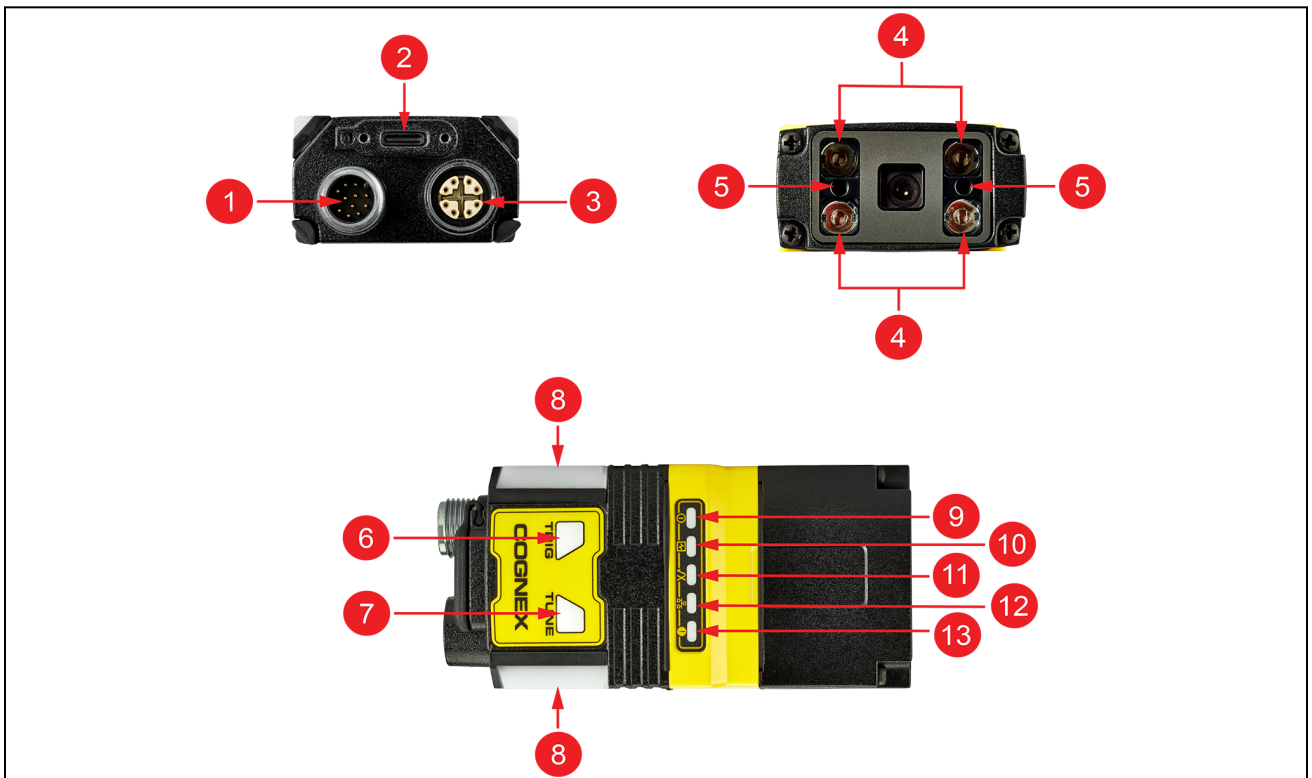

Number	Description
1	Power I/O Breakout cable connector
2	USB-C slot (with plastic cover)
3	Ethernet connector
4	Illumination LEDs
5	LED aimer

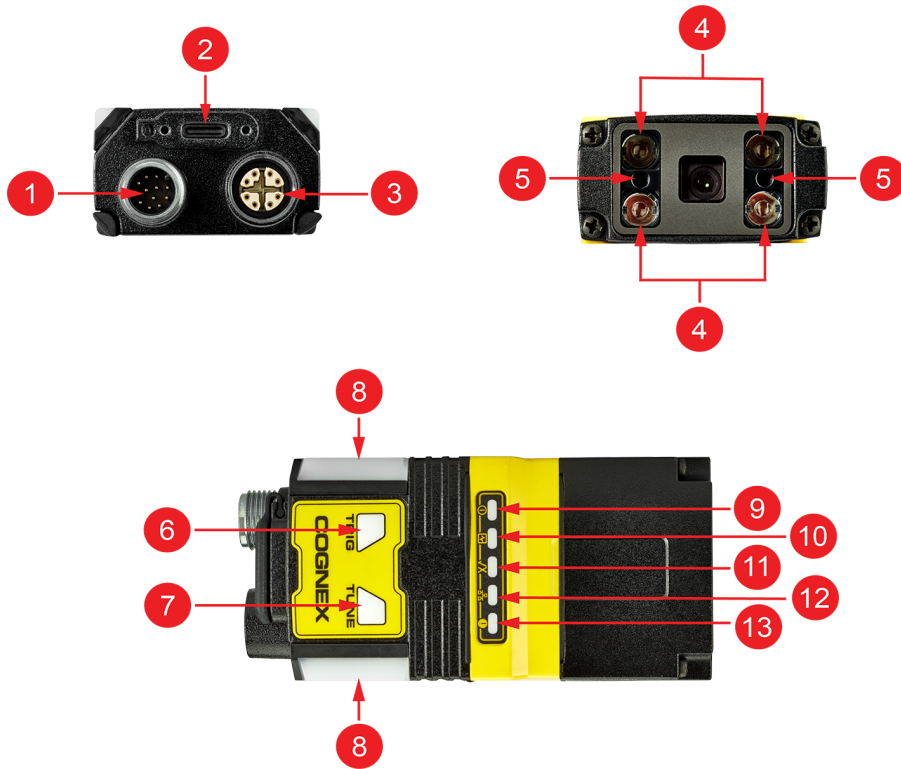

Number	Description
6	Trigger button ⓘ Note: The Trigger Button is not supported.
7	Tune button ⓘ Note: The Tune Button is not supported.
8	Indicator LEDs
9	Power LED indicator
10	Train status/Trigger status LED indicator
11	Good/bad inspection LED indicator
12	Communication LED indicator
13	Error LED indicator

Dimensions

The following sections list dimensions of the vision sensor.

Note:



- Dimensions are in millimeters and are for reference purposes only.
- All specifications are for reference purposes only and can change without notice.

In-Sight SnAPP with 16 mm Lens

The following image shows the dimensions of In-Sight SnAPP equipped with 16 mm lens.

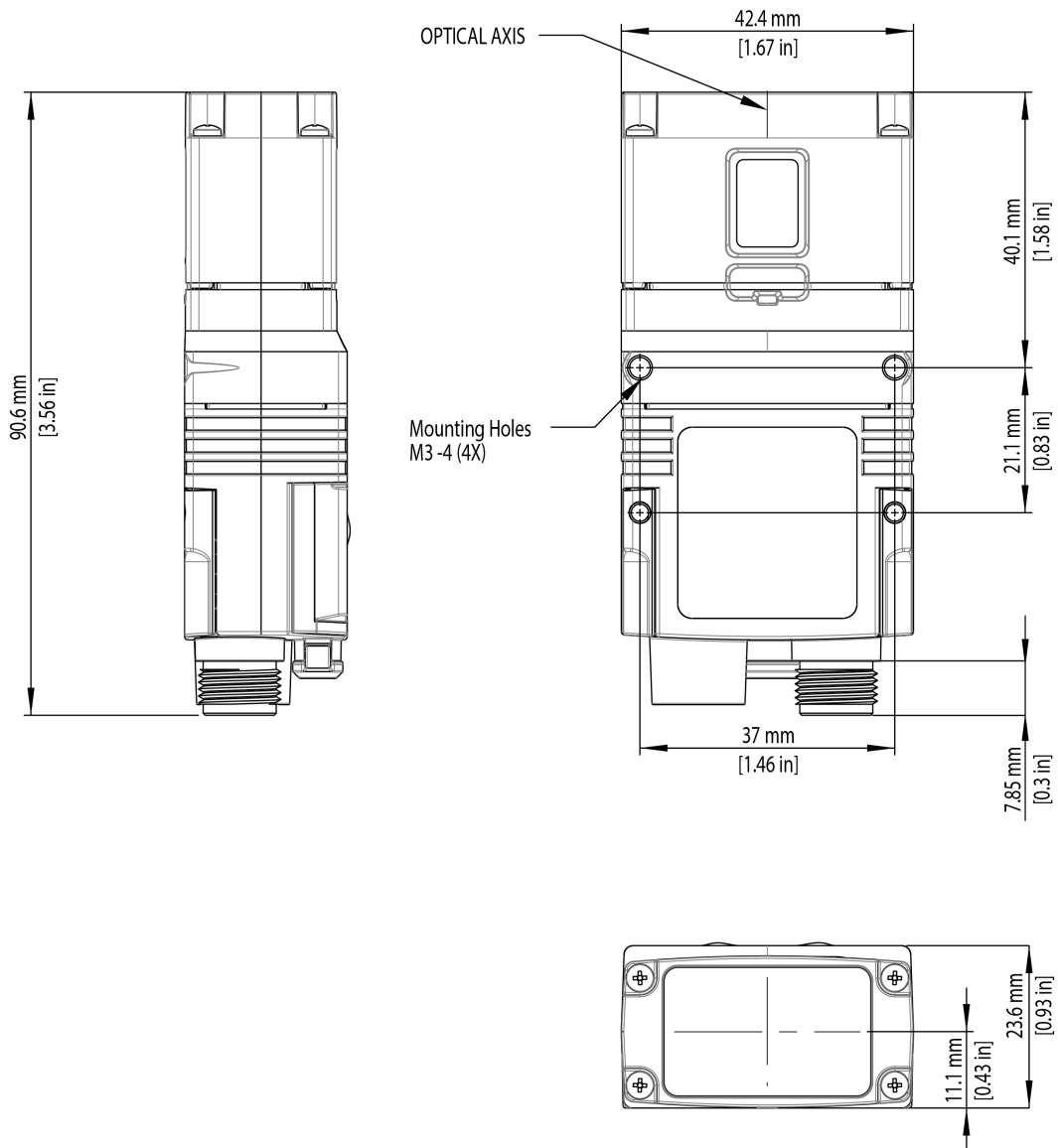

In-Sight SnAPP with 6.2 mm Lens - Right Angle Configuration

The following image shows the dimensions of In-Sight SnAPP equipped with L-shaped extension and 6.2 mm lens.

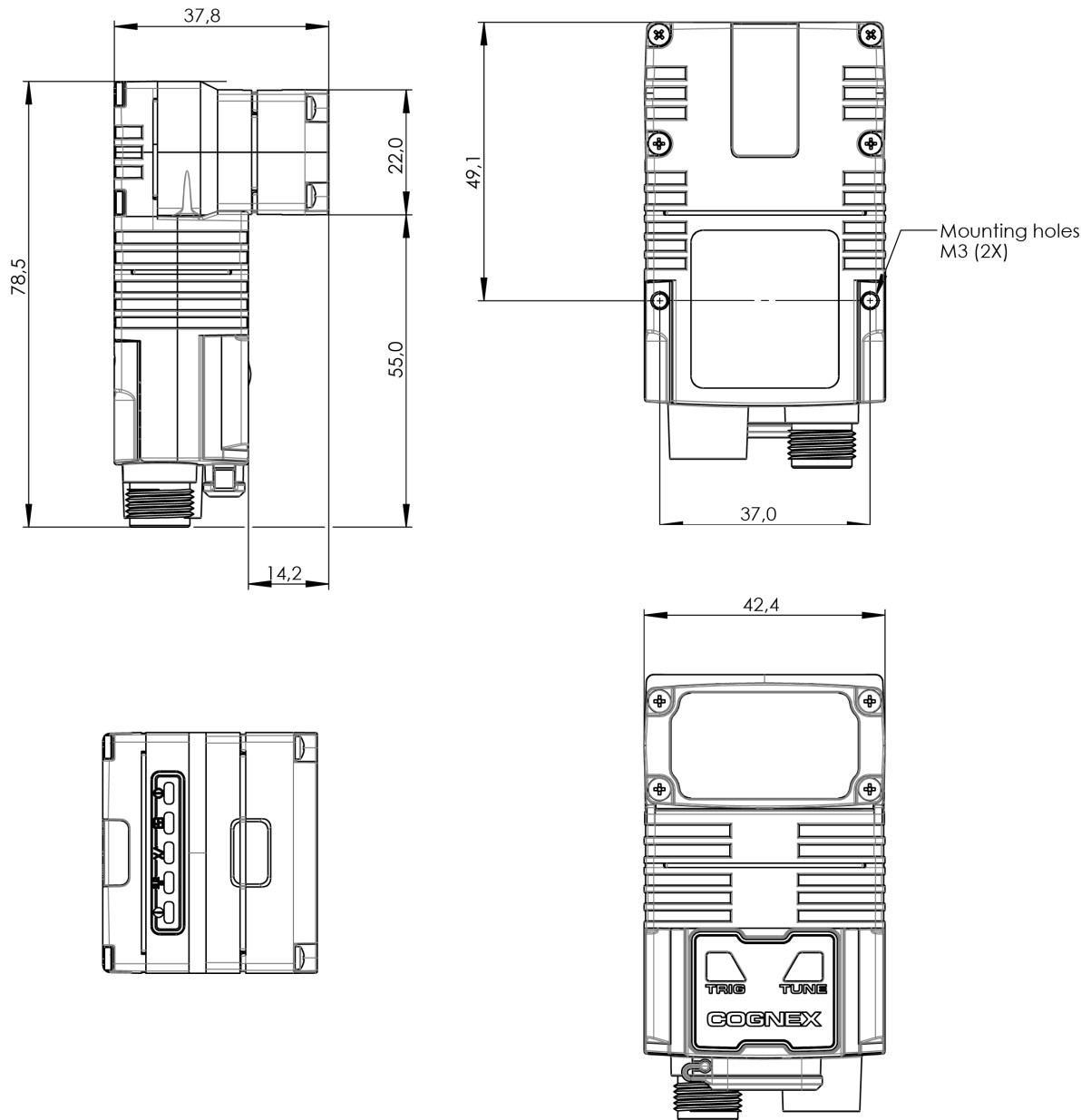

Field of View and Working Distance

This section provides the Field of View (FoV) values for the In-Sight SnAPP configurations. (On the diagrams, the values at the top are in mm and the values at the bottom of the top values in the brackets are in inch).

In-Sight SnAPP with 6.2 mm Lens

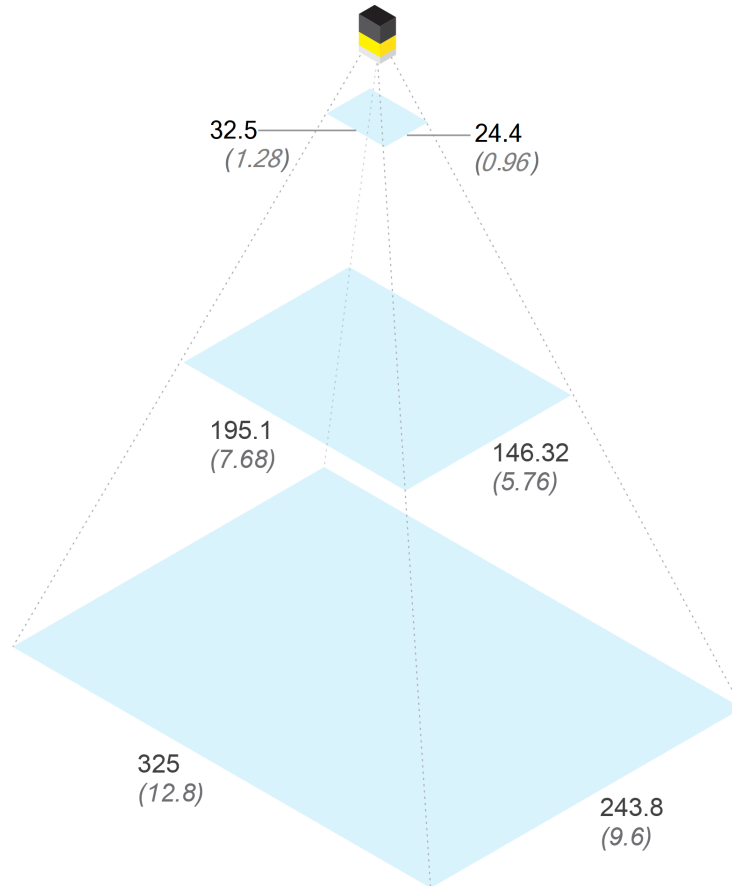

	Working Distance	Horizontal FOV	Vertical FOV
Minimum	50 mm (1.97 in)	32.5 mm (1.28 in)	24.4 mm (0.96 in)
Midpoint	300 mm (11.8 in)	195.1 mm (7.68 in)	146.3 mm (5.76 in)
Maximum	500 mm (19.69 in)	325 mm (12.8 in)	243.8 mm (9.60 in)

In-Sight SnAPP Mini with 16 mm Lens

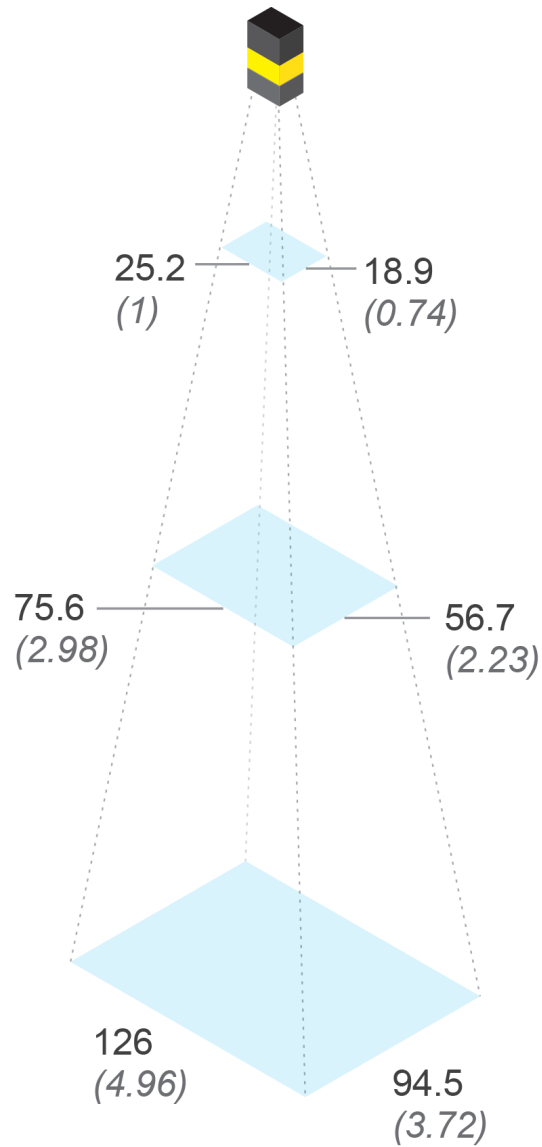

	Working Distance	Horizontal FOV	Vertical FOV
Minimum	200 mm (7.87 in)	25.2 mm (1 in)	18.9 mm (0.74 in)
Midpoint	450 mm (17.72 in)	75.6 mm (2.98 in)	56.7 mm (2.23 in)
Maximum	700 mm (27.56 in)	126 mm (4.96 in)	94.5 mm (3.72 in)

Connecting the Vision Sensor



1	Mounting the Vision Sensor on page 1
2	Connecting the Ethernet Cable on page 21
3	Connecting the Power and I/O Breakout Cable on page 22

Mounting the Vision Sensor

CAUTION: The vision sensor has to be grounded, either by mounting the vision sensor to a fixture that is electrically grounded or by attaching a wire from the vision sensor's mounting fixture to frame ground or Earth ground. If a ground wire is used, it has to be attached to one of the mounting points on the bottom plate of the vision sensor and not to the mounting points on the front of the vision sensor.

1. Align the vision sensor with the holes on the universal mounting bracket.

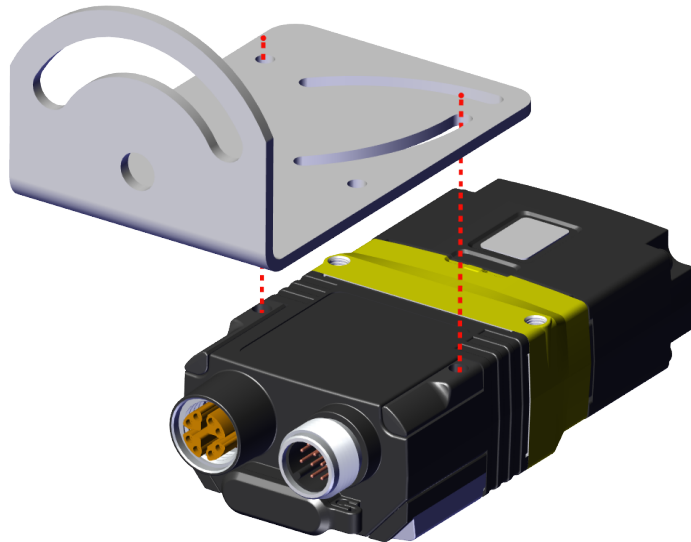
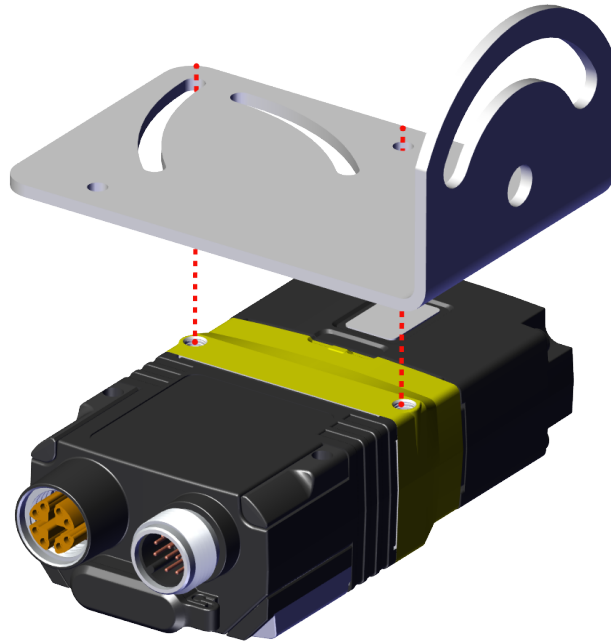

2. Insert the screws.

Note: The vision sensor has two sets of threaded holes for mounting. Use only one set depending on the best configuration for your application. For the threaded holes closer to the front of the vision sensor you need M3X5 screws, for those closer to the connectors M3X9.

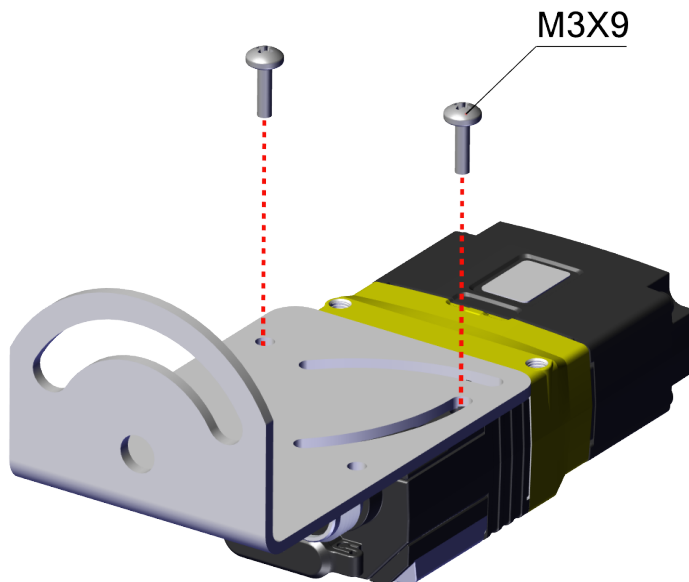
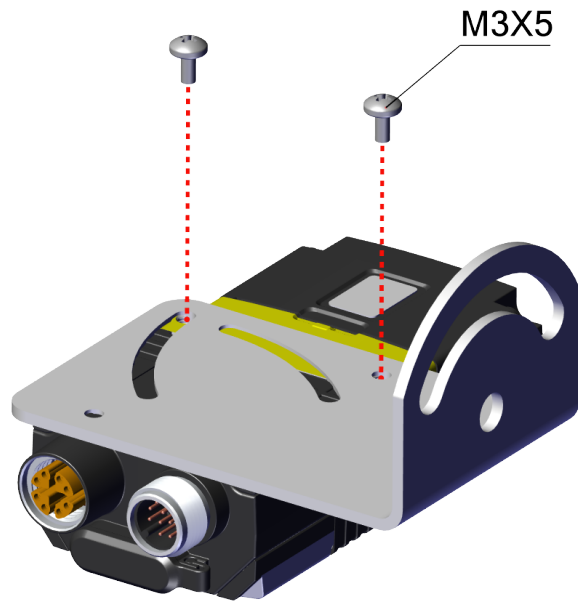

3. If needed, you can rotate the mounting bracket up to 45 degrees. To do so, loosen the screw in the curved slot.

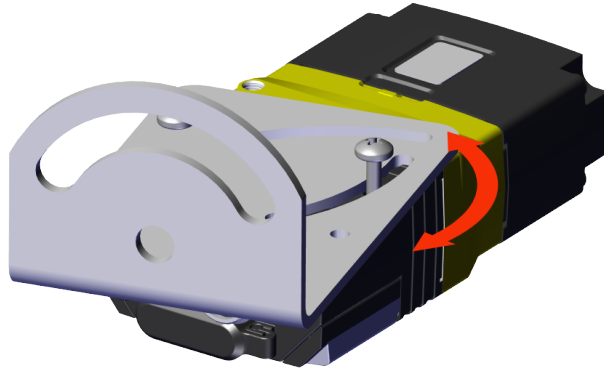
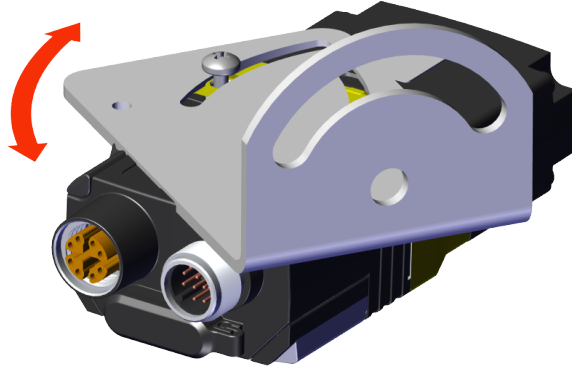

Note:

Mounting the vision sensor at a slight, 15 degree angle reduces reflections and improves performance.

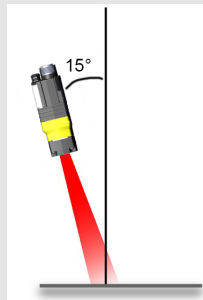

Connecting the Ethernet Cable

CAUTION: The Ethernet cable shield has to be grounded at the far end. Whatever this cable is plugged into (typically a switch or router) should have a grounded Ethernet connector. A digital voltmeter has to be used to validate the grounding. If the far end device is not grounded, a ground wire should be added in compliance with local electrical codes.

1. Connect the Ethernet cable's M12 connector to the vision sensor ENET connector.
2. Connect the Ethernet cable's RJ-45 connector to a switch/router or PC, as applicable.

Note: Besides powering the vision sensor through a Breakout Cable, it is possible to power through PoE (Power over Ethernet) connection as well, in which case it is not necessary to use a Breakout Cable. In-Sight SnAPP configurations support PoE connection.

Connecting the Power and I/O Breakout Cable

⚠ CAUTION: To reduce emissions, connect the far end of the Breakout cable shield to frame ground.

Note:



- Perform wiring or adjustments to I/O devices when the vision sensor is not receiving power.
- You can clip unused wires short or use a tie made of non-conductive material to tie them back. Keep bare wires separated from the +24 V DC wire.

1. Verify that the 24 V DC power supply is unplugged and not receiving power.
2. Attach the +24 V DC connector of the Power and I/O Breakout cable and Ground wires to the corresponding terminals on the power supply. For more information, see [Specifications on page 29](#).
3. Attach the M12 connector of the Power and I/O Breakout Cable to the 24 V DC connector of the vision sensor.
4. Restore power to the 24 V DC power supply and turn it on if necessary.

Indicator LEDs

The table summarizes the functions of the indicator LEDs on In-Sight SnAPP vision sensors.

Indicator	Color/Status	Meaning
User indicator LEDs	GREEN, blinking	Light edges blink in GREEN when the device produces a pass result. i Note: In case of a pass result, the Pass/Fail indicator LED is also blinking in GREEN.
	RED, blinking	Light edges blink in RED when the device produces a fail result when it does not find a decoding after a timeout. i Note: In case of a fail result, the Pass/Fail indicator LED is also blinking in RED.
	WHITE	Light edges are WHITE when you trigger the Identify function in In-Sight SnAPP.
Power indicator LED	ON	The device is ON.
	OFF	The device is OFF.
Train/Trigger status indicator LED	ON	If the device has a trained code, this LED is GREEN.
	OFF	If the device has no trained code, this LED is OFF.
Pass/Fail indicator LED	GREEN, blinking	The device produces a pass result. i Note: In case of a pass result, light edges are also blinking in GREEN.
	RED, blinking	The device produces a fail result when it does not find a decoding after a timeout. i Note: In case of a fail result, light edges are also blinking in RED.
Communication	ON	This LED is on when the In-Sight SnAPP established the Ethernet connection.
	OFF	This LED is OFF when there is no Ethernet connection.
Error	ON	This LED is on if the In-Sight SnAPP vision sensor detects an error.

The Pass and Fail conditions for different applications are the following:

Result	Anomaly Detector	2-Class Classifier
Pass	OK	OK
Fail	<ul style="list-style-type: none">• NG• Fixture or ROI failed	<ul style="list-style-type: none">• NG• Unclassified• Fixture or ROI failed

Using Your In-Sight SnAPP Vision Sensor

This section provides information on the installation of the In-Sight SnAPP, trigger types, and protocols.

How to Connect to the Vision Sensor

To connect to In-Sight SnAPP, perform the following steps:

1. Connect your vision sensor to a power source and the network.
2. Launch Cognex Device Discovery Utility. Make sure your PC is on the same network as your vision sensor.
3. Select your vision sensor from the list of available devices. If you have multiple Cognex products on your network, sort the list of available devices by Model by clicking on **Model**. You can also search for the Serial Number of your vision sensor by typing it into the search bar on the top left. The Serial Number is found on the sticker on your vision sensor, listed as S/N.
4. Click **Connect** to be redirected to the IP address of your vision sensor.

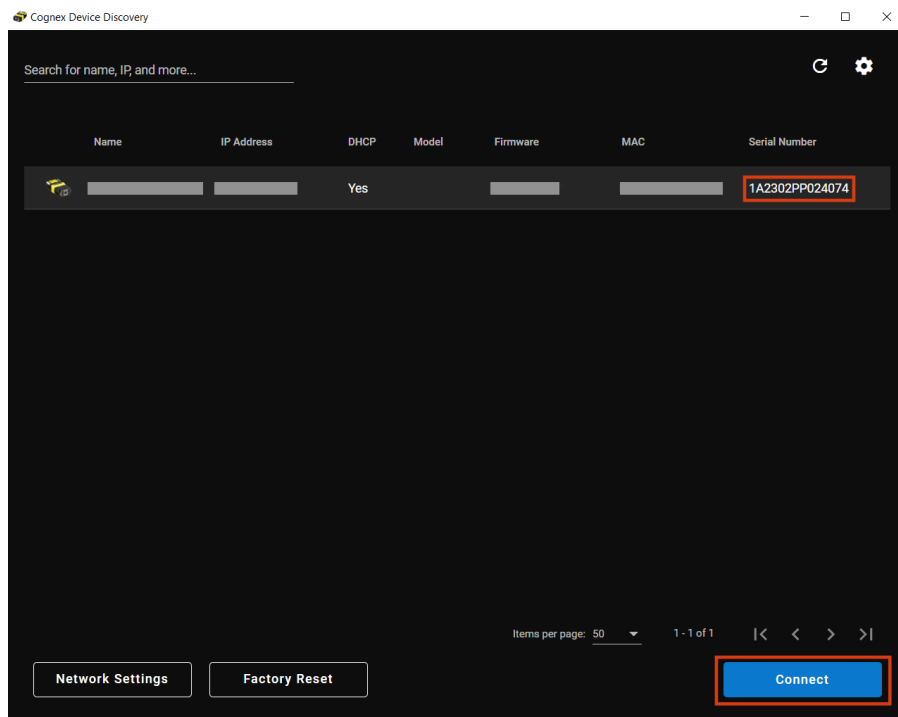

Network Settings

Configure the settings of your vision sensor by clicking on **Network Settings**. You can change the **Host Name** or set a **User Name** and a **Password**. You can also import network settings by clicking on the **Import Settings** button. Click **Apply** to save your changes.

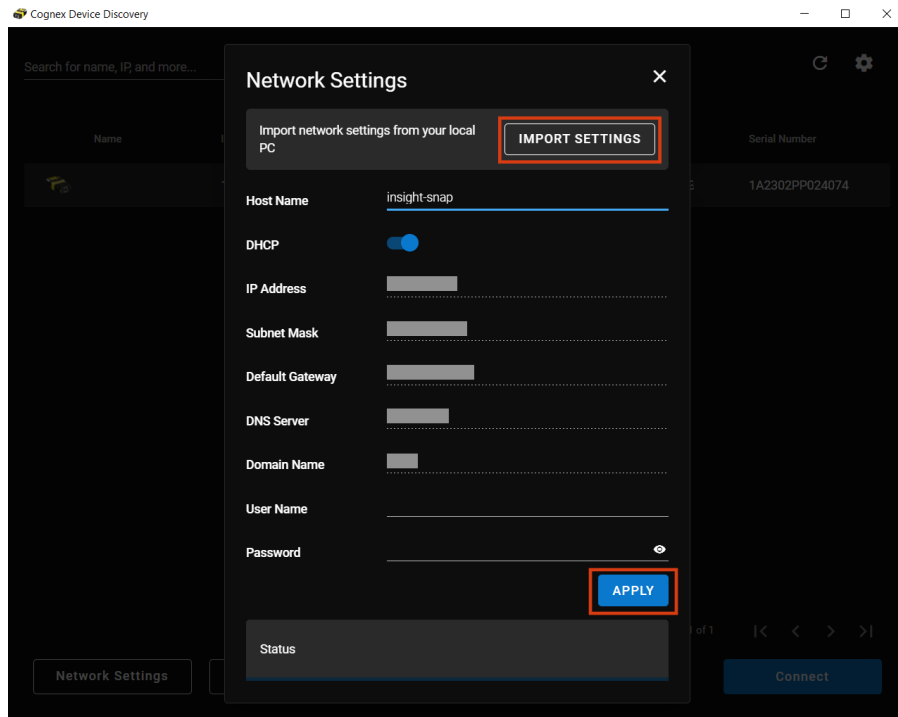

Factory Reset

Reset your vision sensor from Cognex Device Discovery Utility by clicking **Factory Reset**.

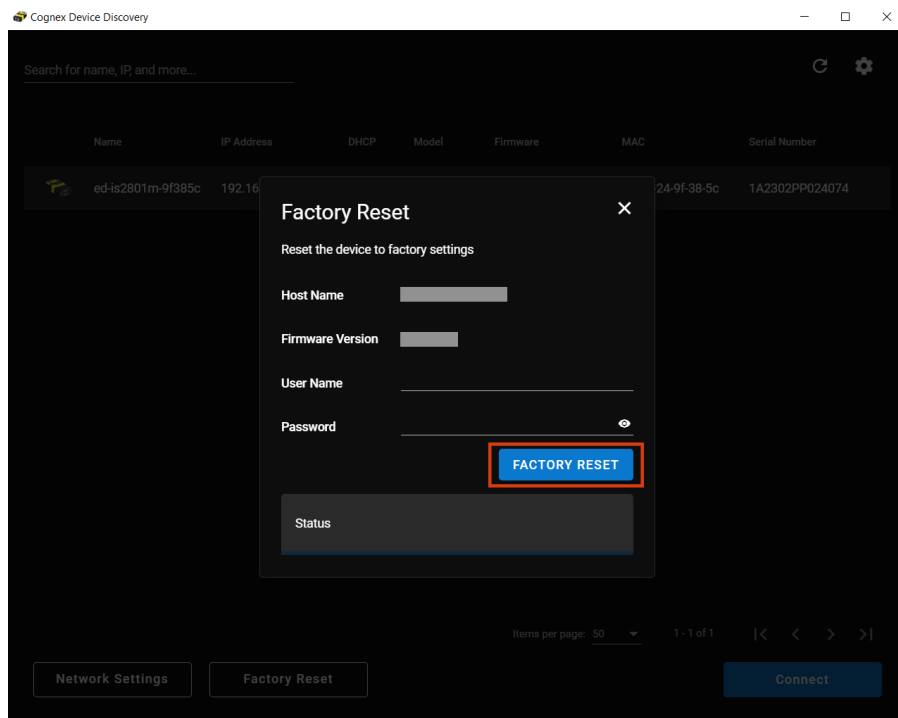

A dialog confirms the completion of resetting your vision sensor to factory settings. Click **OK** to proceed.

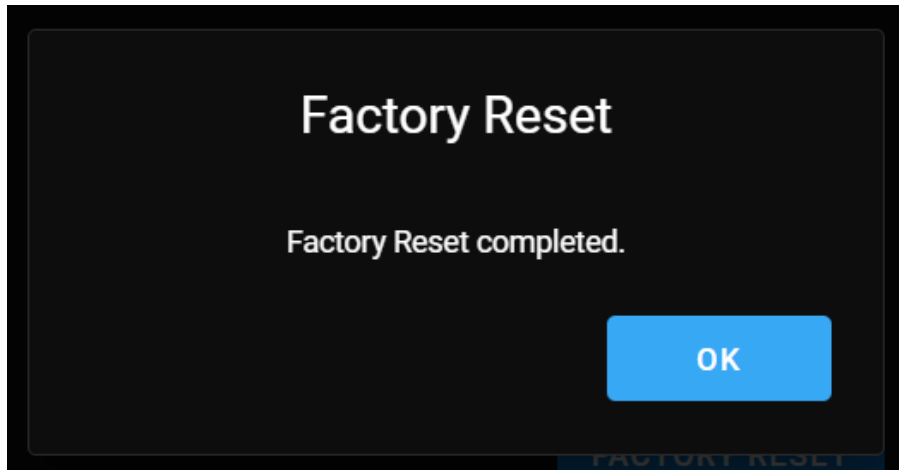

Trigger Types

The In-Sight SnAPP vision sensors support the following trigger modes:

- **Self:** At a time interval you configure between 400 ms and 2000 ms, the vision sensor acquires an image and runs the job continuously.
- **Single:** Using an external trigger source, the vision sensor acquires an image and runs the job.

Industrial Protocols

The vision sensor supports the following industrial protocols:

- EtherNet/IP™, EDS and PLC
- PROFINET (Class B)
- SFTP

Specifications

The following sections list general specifications for the vision sensor.

In-Sight SnAPP Series Vision Sensor

Specification	In-Sight SnAPP
Weight	6.2 mm: 141 g 16 mm: 169 g Right angle configuration adds 50 g
Power	24 V DC +/- 10%, PoE (Power over Ethernet)
Power Consumption	≤ 7.5 W
Operating Temperature	0–40 °C (32–104 °F)
Storage Temperature	-10–60 °C (14–140 °F)
Humidity	<95% non-condensing
Environmental	IP67 Note: IP67 rating applies only if all blind plugs and cables are attached properly, or the provided connector plug is installed. Also, make sure that the IP67-rated cover is installed properly.
Shock (Shipping and Storage)	IEC 60068-2-27: 1000 shocks, semi-sinusoidal, 11 g, 10 ms ISTA-1A Standardized Testing - Packaged Products 150 lb or less
Vibration (Shipping and Storage)	IEC 60068-2-6: vibration test in each of the three main axis for 2 hours @ 10 Gs (10 to 500 Hz at 100m/s ² / 15 mm) FedEx Vibration Testing for packaged products 150 lbs or less
RS-232	RxD, TxD according to TIA/EIA-232-F
High-Speed Outputs 0, 1, 2, 3	I_{MAX} : 50 mA V_{OL} : ≤ ± 3 V @ 50 mA
Inputs 0 (Trigger), 1, 2, 3	V_{IL} : ≤ ± 6 V V_{IH} : ≥ ± 12 V I_{TYP} : 4.2 mA @ 24 V
Ethernet	10/100/1000. Full duplex or half duplex.
Program Storage	20 for each Application

In-Sight SnAPP Series Vision Sensor Image Sensor

Specification	In-SightSnAPP
Image Sensor	1/2.8-inch CMOS monochrome and color
Image Sensor Properties	Pixel size: 2.8 μm (H) x 2.8 μm (V)

Specification	In-SightSnAPP
Image Resolution (pixels)	1440 x 1080 (1.6 mp)
Lens Type	Autofocus: 6.2 mm, 16 mm (High Speed Liquid Lens)

LED and Laser Wavelengths

Model	LED	Wavelength
In-Sight SnAPP Series Vision Sensor with 6.2mm Lens Illumination/with 16mm Lens and High Powered Illumination	White	Chromaticity coordinates acc. to CIE 1931 • Cx 0.34 (typ.) • Cy 0.33 (typ.)
	Red	617 nm

Acquisition Trigger Input

The vision sensor features one acquisition trigger input, which is optically isolated. You can configure the acquisition trigger input to trigger from an NPN (current sinking) or PNP (current sourcing) device.

- To trigger from an NPN type photoelectric sensor or PLC output, connect COMMON IN to +24 VDC and connect IN 0 to the output of the photoelectric sensor. When the output turns ON, it pulls TRIGGER down to 0 VDC, turning the opto-coupler ON.
- To trigger from a PNP photoelectric sensor or PLC output, connect IN 0 to the output of the photoelectric sensor and connect COMMON IN to 0 VDC. When the output turns ON, it pulls TRIGGER up to +24 VDC, turning the opto-coupler ON.

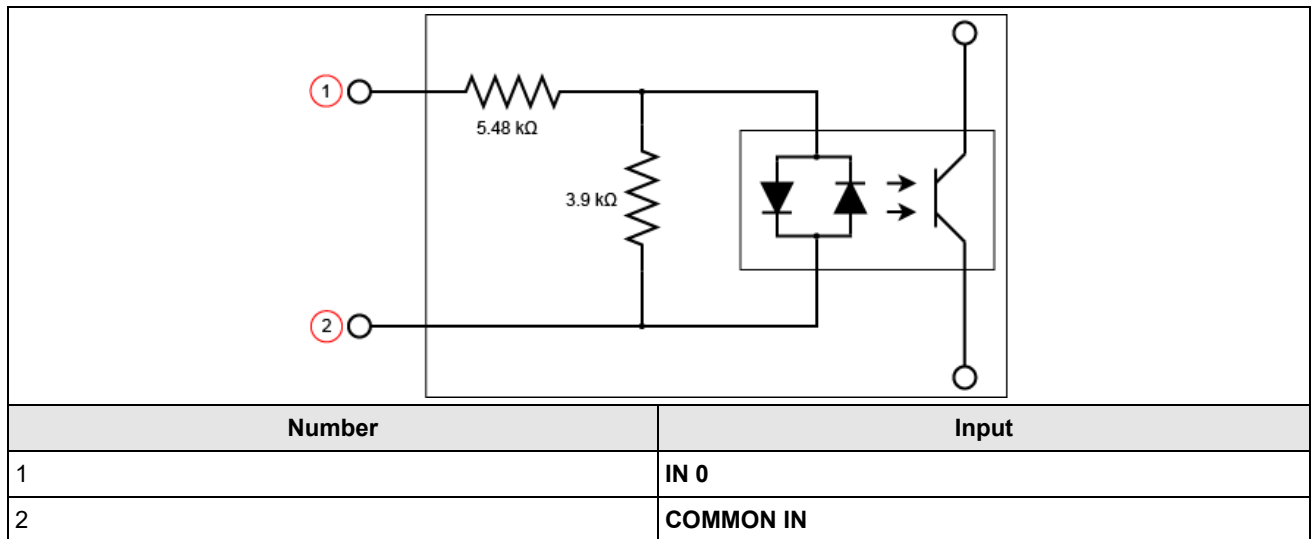

High-Speed Outputs

Specification	Description
Voltages	V_{MAX} : 26 VDC through external load V_{OL} : $\leq \pm 3$ V @ 50 mA
Current	I_{MAX} : 50 mA maximum sink or source current Each line is protected against over-current, short circuits and transients from switching inductive loads. High current inductive loads require an external protection diode.

For NPN lines, the external load should be connected between the output and the positive supply voltage (< 26 VDC). The output pulls down to less than 3 VDC when ON, which causes current to flow through the load. When the output is OFF, no current flows through the load.

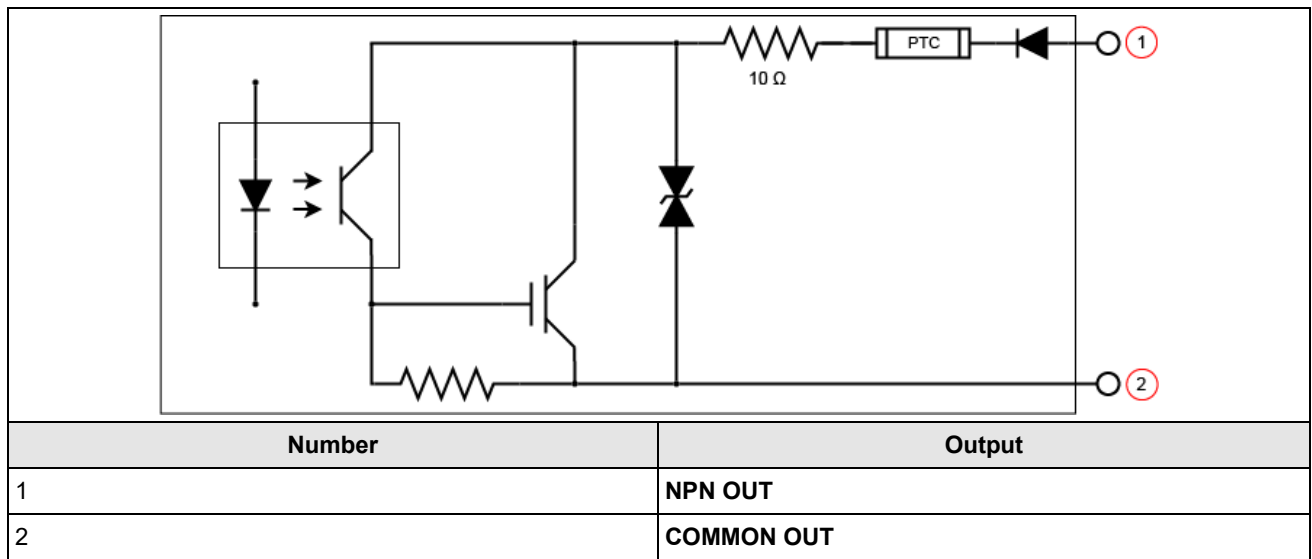

For PNP lines, the external load should be connected between the output and the negative supply voltage (0 VDC). When connected to a 24 VDC power supply, the output pulls up greater than 21 VDC when ON, and current flows through the load. When the output is OFF, no current flows through the load.

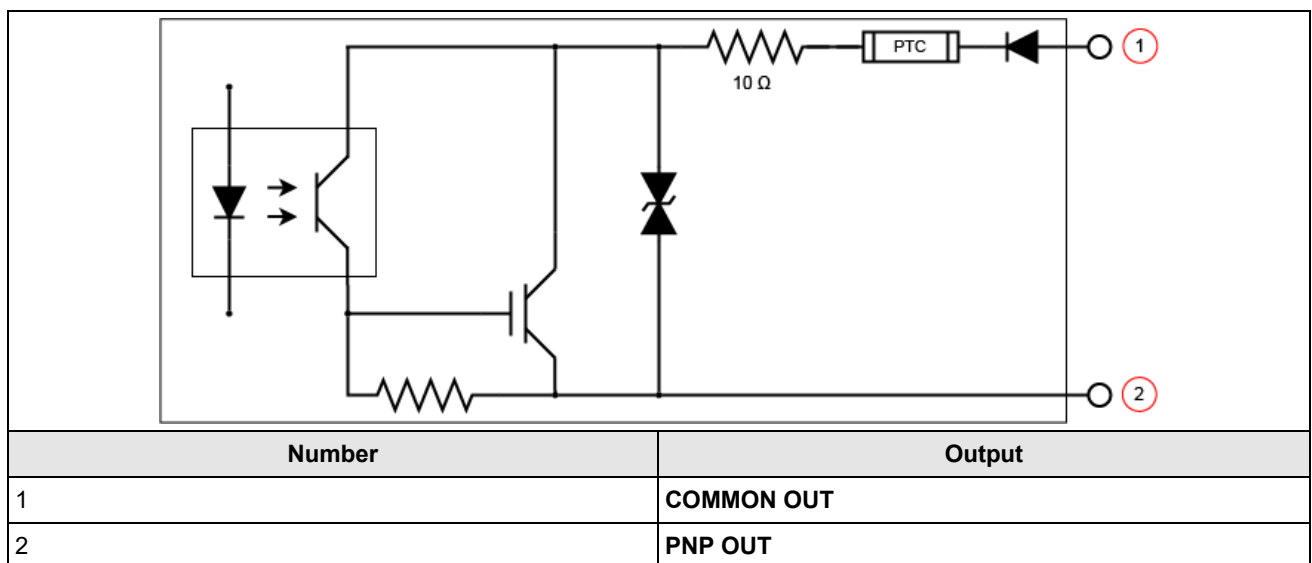

High Speed Output Wiring

To connect to an NPN-compatible PLC input, connect one of the vision sensor's high-speed outputs directly to the PLC input. When enabled, the output pulls the PLC input down to less than 3 VDC.

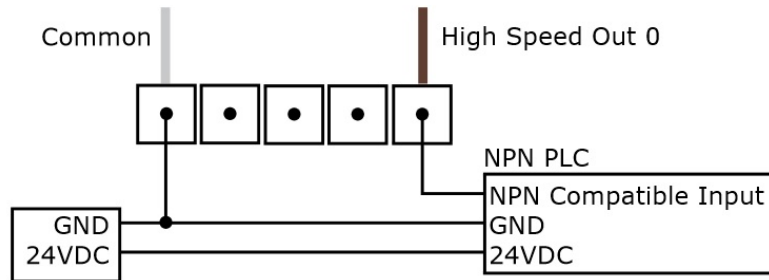

To connect to a PNP-compatible PLC input, connect one of the vision sensor's high-speed outputs directly to the PLC input. When enabled, the output pulls the PLC input up to greater than 21 VDC.

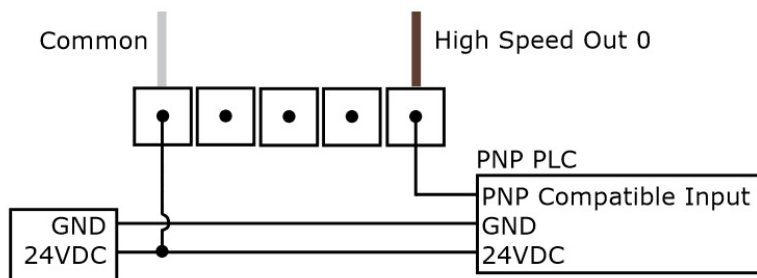

To connect the high-speed outputs to a relay, LED or similar load, connect the negative side of the load to the output and the positive side to +24VDC. When the output switches on, the negative side of the load is pulled down to less than 3 VDC, and 21 VDC appears across the load. Use a protection diode for a large inductive load, with the anode connected to the output and the cathode connected to +24 VDC.

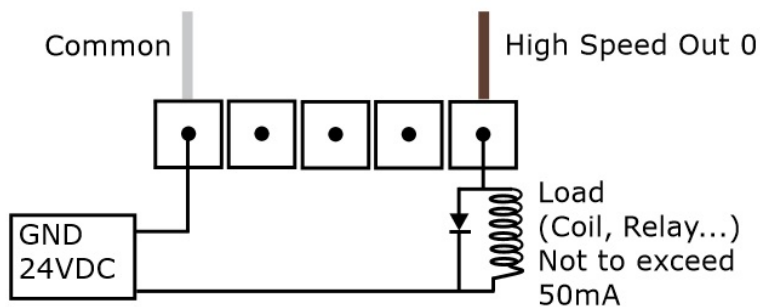

Ethernet Cable

The Ethernet cable provides Ethernet connectivity to the vision sensor. The Ethernet cable is used to connect the vision sensor to other network devices.

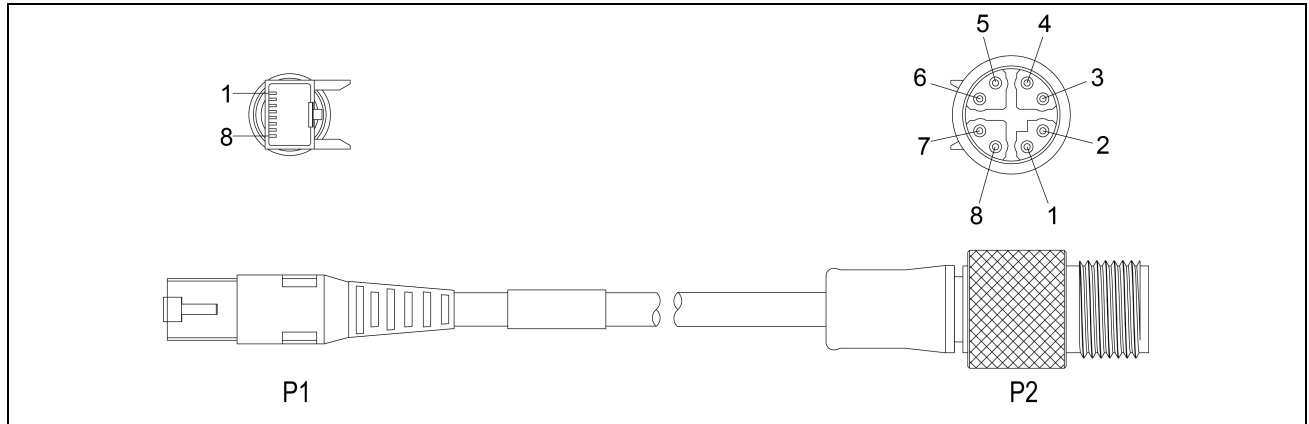

P1 Pin Number	Wire Color	Signal Name	P2 Pin Number
1	White/Orange	TxRx A +	1
2	Orange	TxRx A -	2
3	White/Green	TxRx B +	3
4	Blue	TxRx C +	8
5	White/Blue	TxRx C -	7
6	Green	TxRx B -	4
7	White/Brown	TxRx D +	5
8	Brown	TxRx D -	6

CAUTION: The Ethernet cable shield has to be grounded at the far end. Whatever this cable is plugged into (typically a switch or router) should have a grounded Ethernet connector. A digital voltmeter has to be used to validate the grounding. If the far end device is not grounded, a ground wire should be added in compliance with local electrical codes.

Note:

- Cables are sold separately.
- The wiring for this cable follows standard industrial Ethernet M12 specifications. It differs from the 568B standard.

Power and I/O Breakout Cable Specifications

CCB-PWRIO-05

The Power and I/O Breakout cable provides access to trigger and high-speed outputs. For RS-232, use the Power Supply return path for ground.

The figure on the left shows the plug on the device.

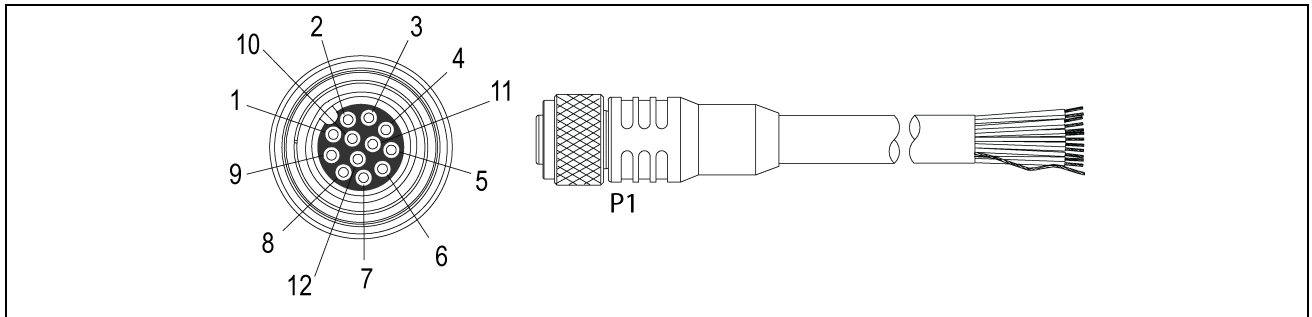

Pin#	Signal Names	Wire Color
1	Out 2/In 2	Yellow
2	TxD	White/Yellow
3	RxD	Brown
4	Out 3/In 3	White/Brown
5	In 1	Violet
6	Common In	White/Violet
7	+24 VDC	Red
8	GND	Black
9	Common Out	Green
10	In 0	Orange
11	Out 0	Blue
12	Out 1	Grey

Note:

- Cables are sold separately.
- Perform wiring or adjustments to I/O devices when the vision sensor is not receiving power.
- You can cut exposed wires short or trim wire ends. You also can tie the wires back if you use a tie made of non-conductive material. Keep bare wires separated from the +24 V DC wire.



Cleaning and Maintenance

Clean the Housing

To clean the outside of the vision sensor housing, use a small amount of mild detergent cleaner or isopropyl alcohol on a cleaning cloth. Do not pour the cleaner on the vision sensor housing.

 **CAUTION:** Do not attempt to clean any In-Sight product with harsh or corrosive solvents, including lye, methyl ethyl ketone (MEK) or gasoline.

Clean the Vision Sensor Image Sensor Window

To remove dust from the outside of the image sensor window, use a pressurized air duster. The air must be free of oil, moisture or other contaminants that could remain on the glass and possibly degrade the image. Do not touch the glass window. If oil or smudges remain, use a cotton bud and alcohol (ethyl, methyl, or isopropyl) to clean the window. Do not pour the alcohol on the window.

Clean the Vision Sensor Lens Cover

To remove dust from the lens cover, use a pressurized air duster. The air must be free of oil, moisture or other contaminants that could remain on the lens cover. To clean the plastic window of the lens cover, use a small amount of isopropyl alcohol on a cleaning cloth. Do not scratch the plastic window. Do not pour the alcohol on the plastic window.

Regulations and Conformity

Note: For the most current CE and UKCA declarations and regulatory conformity information, see the Cognex support site: cognex.com/support.

In-Sight SnAPP vision sensors have Regulatory Model number 50208, 50210, 50215, 50216 and meet or exceed the requirements of all applicable standards organizations for safe operation. However, as with any electrical equipment, the best way to ensure safe operation is to operate them according to the agency guidelines that follow. Please read these guidelines carefully before using your device.

Safety and Regulatory	
Manufacturer	Cognex Corporation One Vision Drive Natick, MA 01760 USA
CE	In-Sight SnAPP 1.6 MP: Regulatory Model 50208 In-Sight SnAPP 1.6 MP L-shaped: Regulatory Model 50210 In-Sight SnAPP 2 MP: Regulatory Model 50215 In-Sight SnAPP 2 MP L-shaped: Regulatory Model 50216 This is a class A product. In a domestic environment this product may cause radio interference in which case the user may be required to take immediate measures. This equipment complies with the essential requirements of the EU Directive 2014/30/EU. Declarations are available from your local representative.
EU RoHS	Compliant to the most recent applicable directive.
FCC	FCC Part 15, Class A This equipment has been tested and found to comply with the limits for a Class A digital device, pursuant to part 15 of the FCC Rules. These limits are designed to provide reasonable protection against harmful interference when the equipment is operated in a commercial environment. This equipment generates, uses, and can radiate radio frequency energy and, if not installed and used in accordance with the instruction manual, may cause harmful interference to radio communications. Operation of this equipment in a residential area is likely to cause harmful interference in which case the user will be required to correct the interference at his own expense.
Korea 	This device is certified for office use only and if used at home, there can be frequency interference problems. A급 기기(업무용 방송통신기자재): 이 기기는 업무용(A급) 전자파적합기기로서 판매자 또는 사용자는 이 점을 주의하시기 바라며, 가정외의 지역에서 사용하는 것을 목적으로 합니다. In-SightSnAPP 1.6 MP: R-R-CGX-50208 In-Sight SnAPP 1.6 MP L-shaped: R-R-CGX-50210 In-Sight SnAPP 2 MP: R-R-CGX-50215 In-Sight SnAPP 2 MP L-shaped: R-R-CGX-50216
TÜV	In-Sight SnAPP 1.6 MP: Regulatory Model 50208 In-Sight SnAPP 1.6 MP L-shaped: Regulatory Model 50210 In-Sight SnAPP 2 MP: Regulatory Model 50215 In-Sight SnAPP 2 MP L-shaped: Regulatory Model 50216 NRTL: TÜV SÜD SCC/NRTL OSHA Scheme for UL/CAN 61010-1. CB report available upon request. TÜV SÜD, IEC/EN 61010-1.

Safety and Regulatory	
UK	<p>Regulatory Model 50208 Regulatory Model 50210 Regulatory Model 50215 Regulatory Model 50216</p> <p>This is a class A product. In a domestic environment, this product can cause radio interference, in which case the user is required to take adequate measures. This equipment complies with the essential requirements of the Electromagnetic Compatibility Regulations 2016. Declarations are available from your local representative.</p>

中国大陆RoHS (Information for China RoHS Compliance)

根据中国大陆《电子信息产品污染控制管理办法》(也称为中国大陆RoHS), 以下部份列出了本产品中可能包含的有毒有害物质或元素的名称和含量。



Part Name 部件名称	Hazardous Substances 有害物质					
	Lead (Pb) 铅	Mercury (Hg) 汞	Cadmium (Cd) 镉	Hexavalent Chromium (Cr (VI)) 六价铬	Polybrominated biphenyls (PBB) 多溴联苯	Polybrominated diphenyl ethers (PBDE) 多溴二苯醚
Regulatory Model 50208	X	O	O	O	O	O
Regulatory Model 50210						
Regulatory Model 50215						
Regulatory Model 50216						

This table is prepared in accordance with the provisions of SJ/T 11364.

这个标签是根据SJ/T 11364 的规定准备的。

O: Indicates that said hazardous substance contained in all of the homogeneous materials for this part is below the limit requirement of GB / T26572 - 2011.

表示本部件所有均质材料中含有的有害物质低于GB / T26572 - 2011 的限量要求。

X: Indicates that said hazardous substance contained in at least one of the homogeneous materials used for this part is above the limit requirement of GB / T26572 - 2011.

表示用于本部件的至少一种均质材料中所含的危害物质超过GB / T26572 - 2011 的限制要求。

For European Community Users

Cognex complies with Directive 2012/19/EU OF THE EUROPEAN PARLIAMENT AND OF THE COUNCIL of 4 July 2012 on waste electrical and electronic equipment (WEEE).

This product has required the extraction and use of natural resources for its production. It may contain hazardous substances that could impact health and the environment, if not properly disposed.

In order to avoid the dissemination of those substances in our environment and to diminish the pressure on the natural resources, we encourage you to use the appropriate take-back systems for product disposal. Those systems will reuse or recycle most of the materials of the product you are disposing in a sound way.



The crossed out wheeled bin symbol informs you that the product should not be disposed of along with municipal waste and invites you to use the appropriate separate take-back systems for product disposal.

If you need more information on the collection, reuse, and recycling systems, please contact your local or regional waste administration.

You may also contact your supplier for more information on the environmental performance of this product.

