

In-Sight[®] D900 Series Vision System Reference Guide

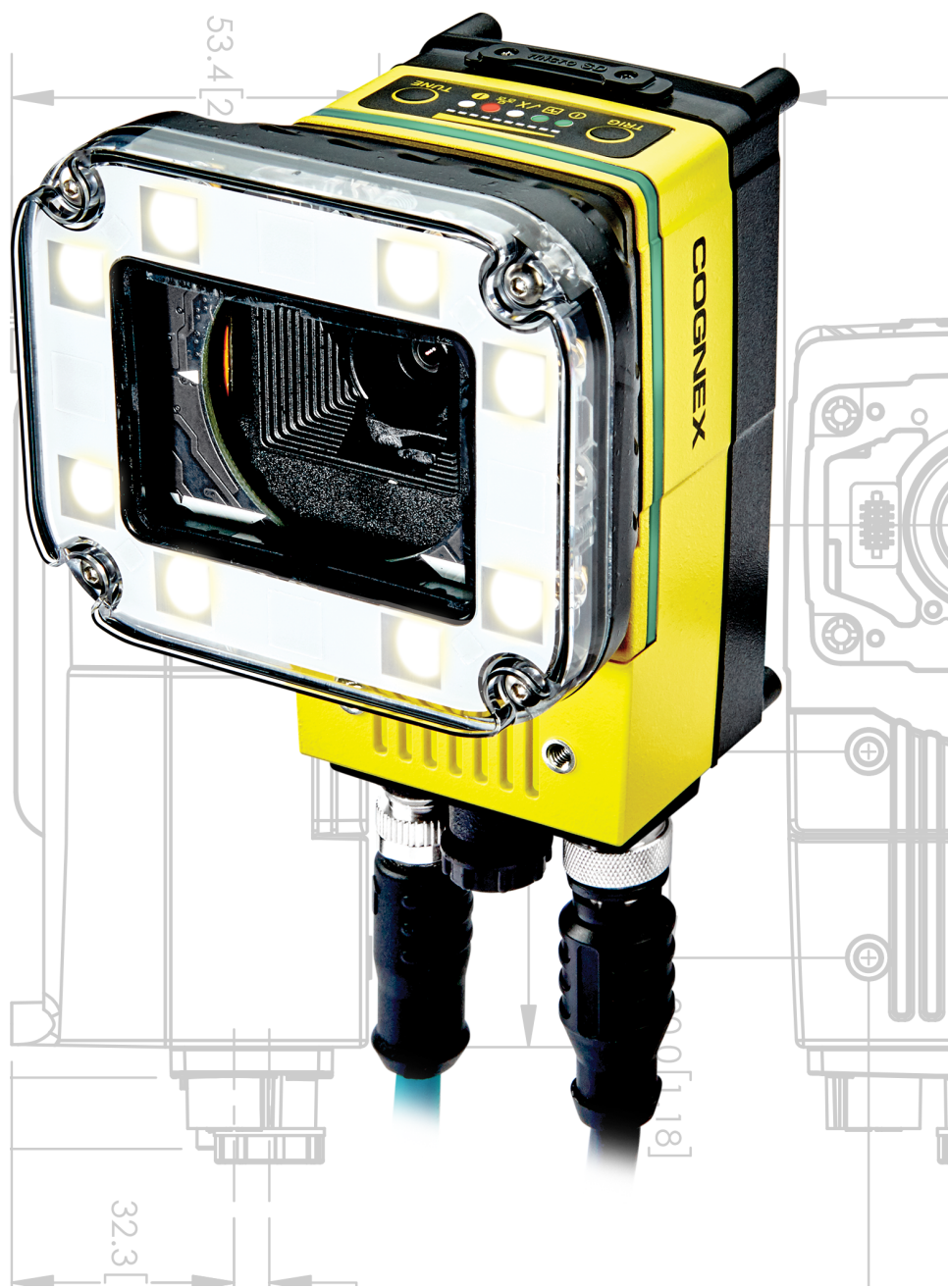

2021 February 01
Revision: 1.3.1.1

Legal Notices

The software described in this document is furnished under license, and may be used or copied only in accordance with the terms of such license and with the inclusion of the copyright notice shown on this page. Neither the software, this document, nor any copies thereof may be provided to, or otherwise made available to, anyone other than the licensee. Title to, and ownership of, this software remains with Cognex Corporation or its licensor. Cognex Corporation assumes no responsibility for the use or reliability of its software on equipment that is not supplied by Cognex Corporation. Cognex Corporation makes no warranties, either express or implied, regarding the described software, its merchantability, non-infringement or its fitness for any particular purpose.

The information in this document is subject to change without notice and should not be construed as a commitment by Cognex Corporation. Cognex Corporation is not responsible for any errors that may be present in either this document or the associated software.

Companies, names, and data used in examples herein are fictitious unless otherwise noted. No part of this document may be reproduced or transmitted in any form or by any means, electronic or mechanical, for any purpose, nor transferred to any other media or language without the written permission of Cognex Corporation.

Copyright © 2020. Cognex Corporation. All Rights Reserved.

Portions of the hardware and software provided by Cognex may be covered by one or more U.S. and foreign patents, as well as pending U.S. and foreign patents listed on the Cognex web site at: cognex.com/patents.

The following are registered trademarks of Cognex Corporation:

Cognex, 2DMAX, Advantage, AlignPlus, Assemblyplus, Check it with Checker, Checker, Cognex Vision for Industry, Cognex VSOC, CVL, DataMan, DisplayInspect, DVT, EasyBuilder, Hotbars, IDMax, In-Sight, Laser Killer, MVS-8000, OmniView, PatFind, PatFlex, PatInspect, PatMax, PatQuick, SensorView, SmartView, SmartAdvisor, SmartLearn, UltraLight, Vision Solutions, VisionPro, VisionView

The following are trademarks of Cognex Corporation:

The Cognex logo, 1DMax, 3D-Locate, 3DMax, BGAll, CheckPoint, Cognex VSoC, CVC-1000, FFD, iLearn, In-Sight (design insignia with cross-hairs), In-Sight 2000, InspectEdge, Inspection Designer, MVS, NotchMax, OCRMax, PatMax RedLine, ProofRead, SmartSync, ProfilePlus, SmartDisplay, SmartSystem, SMD4, VisiFlex, Xpand



Portions copyright © Microsoft Corporation. All rights reserved.

Portions copyright © MadCap Software, Inc. All rights reserved.

Other product and company trademarks identified herein are the trademarks of their respective owners.

Regulations and Conformity

Note: For the most current CE declaration and regulatory conformity information, see the Cognex support site: cognex.com/support.

Safety and Regulatory	
Manufacturer	Cognex Corporation One Vision Drive Natick, MA 01760 USA
	In-Sight D902/D902C: Regulatory Model 50118 In-Sight D905/D905C: Regulatory Model R00099 This is a class A product. In a domestic environment this product may cause radio interference in which case the user may be required to take immediate measures. This equipment complies with the essential requirements of the EU Directive 2014/30/EU. Declarations are available from your local representative.
EU RoHS	Compliant to the most recent applicable directive.
FCC	FCC Part 15, Class A This equipment has been tested and found to comply with the limits for a Class A digital device, pursuant to part 15 of the FCC Rules. These limits are designed to provide reasonable protection against harmful interference when the equipment is operated in a commercial environment. This equipment generates, uses, and can radiate radio frequency energy and, if not installed and used in accordance with the instruction manual, may cause harmful interference to radio communications. Operation of this equipment in a residential area is likely to cause harmful interference in which case the user will be required to correct the interference at his own expense.
Korea 	In-Sight D902/D902C: Regulatory Model 50118: R-R-CGX-50118 In-Sight D905/D905C: Regulatory Model R00099: R-R-CGX-R00099 This device is certified for office use only and if used at home, there can be frequency interference problems.
TÜV	In-Sight D902/D902C: Regulatory Model 50118 In-Sight D905/D905C: Regulatory Model R00099
	NRTL: TÜV SÜD AM SCC/NRTL OSHA Scheme for UL/CAN 61010-1.
	CB report available upon request. TÜV SÜD AM, IEC/EN 61010-1.

China RoHS



Part Name 部件名称	Hazardous Substances 有害物质					
	Lead (Pb) 铅	Mercury (Hg) 汞	Cadmium (Cd) 镉	Hexavalent Chromium (Cr (VI)) 六价铬	Polybrominated biphenyls (PBB) 多溴联苯	Polybrominated diphenyl ethers (PBDE) 多溴二苯醚
Regulatory Model 50118 R00099	X	O	O	O	O	O

This table is prepared in accordance with the provisions of SJ/T 11364.
这个标签是根据SJ/T 11364 的规定准备的。

O: Indicates that said hazardous substance contained in all of the homogeneous materials for this part is below the limit requirement of GB / T26572 - 2011.
表示本部件所有均质材料中含有的有害物质低于GB / T26572 - 2011 的限量要求。

X: Indicates that said hazardous substance contained in at least one of the homogeneous materials used for this part is above the limit requirement of GB / T26572 - 2011.
表示用于本部件的至少一种均质材料中所含的危害物质超过GB / T26572 - 2011 的限制要求。

For European Community Users

Cognex complies with Directive 2012/19/EU OF THE EUROPEAN PARLIAMENT AND OF THE COUNCIL of 4 July 2012 on waste electrical and electronic equipment (WEEE).

This product has required the extraction and use of natural resources for its production. It may contain hazardous substances that could impact health and the environment, if not properly disposed.

In order to avoid the dissemination of those substances in our environment and to diminish the pressure on the natural resources, we encourage you to use the appropriate take-back systems for product disposal. Those systems will reuse or recycle most of the materials of the product you are disposing in a sound way.



The crossed out wheeled bin symbol informs you that the product should not be disposed of along with municipal waste and invites you to use the appropriate separate take-back systems for product disposal.

If you need more information on the collection, reuse, and recycling systems, please contact your local or regional waste administration.

You may also contact your supplier for more information on the environmental performance of this product.

Precautions

To reduce the risk of injury or equipment damage when you install the Cognex product, observe the following precautions:

- The vision system requires a UL or NRTL listed power supply with a 24VDC output that meets the following rating requirements:
 - At least 5A continuous current.
 - Output rated SELV or National Electrical Code (NEC) Class 2.

Any other voltage creates a risk of fire or shock and can damage the components. Applicable national and local wiring standards and rules must be followed.

- This product is intended for industrial use in automated manufacturing or similar applications.
- The safety of any system incorporating this product is the responsibility of the assembler of the system.
- Do not install Cognex products where they are exposed to environmental hazards such as excessive heat, dust, moisture, humidity, impact, vibration, corrosive substances, flammable substances, or static electricity.
- Route cables and wires away from high-current wiring or high-voltage power sources to reduce the risk of damage or malfunction from the following causes: over-voltage, line noise, electrostatic discharge (ESD), power surges, or other irregularities in the power supply.
- Do not expose the image sensor to laser light. Image sensors can be damaged by direct, or reflected, laser light. If your application requires laser light that might strike the image sensor, use a lens filter at the corresponding laser wavelength. For suggestions, contact your local integrator or application engineer.
- This product does not contain user-serviceable parts. Do not make electrical or mechanical modifications to product components. Unauthorized modifications can void your warranty.
- Changes or modifications not expressly approved by the party responsible for regulatory compliance could void the user's authority to operate the equipment.
- Include service loops with cable connections.
- Ensure that the cable bend radius begins at least six inches from the connector. Cable shielding can be degraded or cables can be damaged or wear out faster if a service loop or bend radius is tighter than 10X the cable diameter.
- This device should be used in accordance with the instructions in this manual.
- All specifications are for reference purposes only and can change without notice.

Table of Contents

Legal Notices	2
Regulations and Conformity	3
China RoHS	4
For European Community Users	4
Precautions	5
Table of Contents	6
Symbols	8
Introduction	9
Support	9
Standard Components	9
Accessories	10
In-Sight Lenses, Lights and Covers	10
External Lights	16
Cables	18
Mounting Brackets	19
Power Supplies	19
Connectors and Indicators	20
Installation	21
Install the Lens, Lighting and Cover	21
Install the C-Mount Lens and Cover (COV-7000-CMNT or COV-7000-CMNT-EX)	21
Install the C-Mount Lens and Cover (COV-7000-CMNT-LG)	23
Install the C-Mount Lens and In-Sight Illumination	24
Install the Autofocus Module and In-Sight Illumination	29
Install the S-Mount/M12 Manual Focus Lens	35
Working Distance and Field of View (S-Mount/M12 Lenses)	37
Mount the Vision System	38
Install the Mounting Bracket (BKT-INS-01)	39
Connect the External Light Cable (Optional)	40
Connect the Ethernet Cable	41
Connect the Breakout Cable	42
Replace the SD Card (Optional)	43
Replace the LED Ring Light (Optional)	44
Replace the M12 Autofocus Lens (Optional)	49
Specifications	58
D902 Vision System Specifications	58
D905 Vision System Specifications	61
Acquisition Trigger Input	64
General-Purpose Inputs	65
High-Speed Outputs	66
High-Speed Output Wiring	67
External Light Connector	68
Ethernet Cable	69
Breakout Cable	70
Dimensions	71

D902 Vision System	71
D905 Vision System	72
D900 Series Vision System with Cover (COV-7000-CMNT)	73
D900 Series Vision System with Cover (COV-7000-CMNT-EX)	74
D900 Series Vision System with Cover (COV-7000-CMNT-LG)	75
D900 Series Vision System with Cover (COV-7000-CMNT-LG) and Extender (COV-7000-CMNT-LGX)	76
D900 Series Vision System with Illumination (ISLM-7000-xxx)	77
Mounting Bracket (BKT-INS-01)	78
C-Mount Lens Clearance Dimensions	79
Cleaning/Maintenance	80
Clean the Housing	80
Clean the Image Sensor Window	80
Clean the Cover	80
Appendix	81
Mechanical Vignetting	81
Remove the Illumination Accessory PCB	82

Symbols

The following symbols indicate safety precautions and supplemental information:

 **WARNING:** This symbol indicates a hazard that could cause death, serious personal injury or electrical shock.

 **CAUTION:** This symbol indicates a hazard that could result in property damage.

 **Note:** This symbol indicates additional information about a subject.

 **Tip:** This symbol indicates suggestions and shortcuts that might not otherwise be apparent.

Introduction

The In-Sight[®] vision system is a compact, network-ready, stand-alone machine vision system used for automated inspection, measurement, identification and robot guidance applications on the factory floor. All models can be easily configured remotely over a network using an intuitive user interface.

Support

Many information resources are available to help you use the vision system:

- The *In-Sight[®] ViDi Help* file.
- The *In-Sight[®] Vision Suite Help* file.

Standard Components

Note:



- Cables are sold separately.
- If a standard component is missing or damaged, immediately contact your Cognex Authorized Service Provider (ASP) or Cognex Technical Support.



Component	Description
Vision System	Provides image acquisition, vision processing, job storage, Ethernet connectivity and discrete I/O. The vision system has an 8GB SD card pre-installed.

Accessories

You can purchase the following components separately. For a list of options and accessories, contact your local Cognex sales representative.

In-Sight Lenses, Lights and Covers



The following In-Sight lenses, lights and covers are supported with the vision system.



C-Mount Standard and Extended Covers

Note:

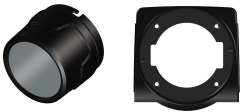
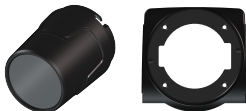
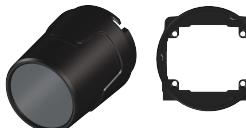
- When using a C-Mount lens, the following restrictions apply:
 - Maximum thread length is 5.25mm.
 - The C-Mount lens threads and body cannot protrude more than 6.5mm in length into the vision system when screwed in unless the diameter of the back lens is smaller than 14.75mm. If the C-Mount lens threads and body protrude more than 6.5mm, you can add a spacer between the lens and vision system. However, the spacer decreases the working distance.
- Refer to [C-Mount Lens Clearance Dimensions on page 79](#) for more information.

CAUTION: If installing a C-Mount cover, the illumination accessory (ISLM-7000-xxx) PCB should not be installed to the vision system. Refer to [Remove the Illumination Accessory PCB on page 82](#) for steps to safely remove the PCB and avoid damage to the vision system.

Accessory	Part Number	Accessory Image
Standard plastic C-Mount cover and lens cover adapter. Note: If using the COV-7000-CMNT cover, the maximum lens length is 41mm, the maximum lens body diameter is 36.5mm and the maximum diameter including locking screws is 47mm.	COV-7000-CMNT	
Standard extended plastic C-Mount cover and lens cover adapter. Note: If using the COV-7000-CMNT-EX cover, the maximum lens length is 62mm, the maximum lens body diameter is 36.5mm and the maximum diameter including locking screws is 46.5mm.	COV-7000-CMNT-EX	
Wide plastic C-Mount cover and lens cover adapter. Note: If using the COV-7000-CMNT-LG cover, the maximum lens length is 77mm, the maximum lens body diameter is 55mm and the maximum diameter including locking screws is 55mm.	COV-7000-CMNT-LG	
Wide plastic 30mm C-Mount extender, compatible with the COV-7000-CMNT-LG cover.	COV-7000-CMNT-LGX	

Accessory	Part Number	Accessory Image
<p>Metal C-Mount lens cover adapter. Compatible with the following In-Sight 5000 series metal C-Mount lens covers:</p> <ul style="list-style-type: none"> • LNS-CVR-EXT01 • LNS-CVR-R-00 • LNS-CVR-UV-00 • LNS-CVR50-AL-2 <p>Note: If using the ADPT-MTL-M55 lens cover adapter, the maximum lens diameter including locking screws is 58.5mm.</p>	ADPT-MTL-M55	
<p>Plugs to cover the integrated light and autofocus connectors on the vision system faceplate. The plugs are used with large lenses that do not fit under C-Mount covers and prevents dust from getting into the vision system. The kit contains:</p> <ul style="list-style-type: none"> • 5 integrated light plugs. • 5 autofocus plugs. <p>Note: The imager is isolated from the rest of the vision system internally, therefore the only way dust will get on the imager is from the C-Mount opening.</p>	IS7000-CON-PLG	

C-Mount Illumination Accessories



Note:





- The vision system supports connecting an integrated illumination accessory to the vision system's faceplate and connecting an external light to the vision system's LIGHT connector, but does not support using both lighting devices simultaneously.
- When using a C-Mount lens, the following restrictions apply:

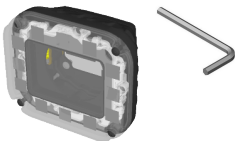

- Maximum thread length is 5.25mm.
- The C-Mount lens threads and body cannot protrude more than 6.5mm in length into the vision system when screwed in unless the diameter of the back lens is smaller than 14.75mm. If the C-Mount lens threads and body protrude more than 6.5mm, you can add a spacer between the lens and vision system. However, the spacer decreases the working distance.

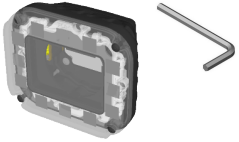
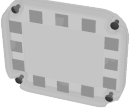
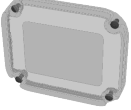
CAUTION: The following C-Mount lenses are supported with vision systems when using the illumination accessory (ISLM-7000-xxx). If using a different C-Mount lens with the illumination accessory, it must be 29.5mm in diameter or smaller. Maximum lens length is 38.5mm without a bandpass filter and 36mm with a bandpass filter. Larger lenses will irreparably damage the vision system.

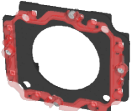



Accessory	Part Number	Accessory Image	
Lenses supported with vision systems with 2.3 mega-pixel resolution and below.	9mm f/1.4 - f/16 aperture lens	LFC-9F1B	
	12.5mm f/1.4 - close aperture lens	LFC-12.5F	
	16mm f/1.4 - f/16 aperture lens	LFC-16F1	
	25mm f/1.4 - f/22 aperture lens	LFC-25F1	
	35mm f/1.6 - f/22 aperture lens	LFC-35F1	
	50mm f/2.3 - f/22 aperture lens	LFC-50F1	
Lenses supported with vision systems with 5 mega-pixel resolution.	8mm f/2.4 - f/16 aperture lens	LMC-ML-M0824-MP5	
	12.5mm f/2.4 - f/16 aperture lens	LMC-ML-M1224-MP5	
	16mm f/1.6 - f/16 aperture lens	LMC-ML-M1616UR	
	25mm f/1.6 - f/16 aperture lens	LMC-ML-M2516UR	
	35mm f/2.0 - f/16 aperture lens	LMC-ML-M3520UR	
Illumination accessory with white LED ring light, cover and hex wrench	ISLM-7000-WHI		

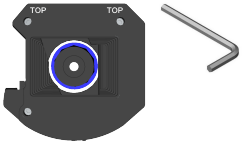

Accessory	Part Number	Accessory Image
Illumination accessory with cover and hex wrench. Does not include an LED ring light.	ISLM-7000-00	
Diffuse cover	COV-7000-DF	
Clear cover	COV-7000-CLR	
Polarized cover Note: When installing the cover, pull the red tab to remove the protective film.	COV-7000-PL-FULL	
Red LED ring light	ISL-7000-RD	
IR LED ring light	ISL-7000-IR	
Blue LED ring light	ISL-7000-BL	
White LED ring light Note: For color vision systems, the white LED ring light should be used.	ISL-7000-WHI	
Red bandpass filter used with the ISL-7000-RD LED ring light	ISF-7000-RDBP605	
IR bandpass filter used with the ISL-7000-IR LED ring light	ISF-7000-IRBP815	
Blue bandpass filter used with the ISL-7000-BL LED ring light	ISF-7000-BLBP435	

S-Mount/M12 Autofocus Accessories

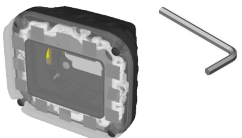
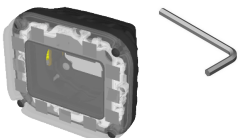
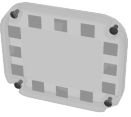
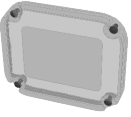
Note:

- The vision system supports connecting an integrated illumination accessory to the vision system's faceplate and connecting an external light to the vision system's LIGHT connector, but does not support using both lighting devices simultaneously.
- For the In-Sight D905, the S-Mount/M12 lens image circle size is smaller than the vision system's image sensor size, resulting in mechanical vignetting in the image when using any S-Mount/M12 lens. Therefore, S-Mount/M12 lenses are not recommended. For more information, see [Mechanical Vignetting on page 81](#).

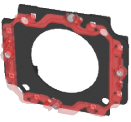
Accessory	Part Number	Accessory Image
Autofocus module with 8mm S-Mount/M12 lens	ISAF-7000-8mm	
Lens removal tool with replacement lens nuts	ISAF-7000-TOOL	
6mm M12 lens	LM12-06-01	
8mm M12 lens	LM12-08-01-F2.2	
12mm M12 lens	LM12-12-01-F2.3	
16mm M12 lens	LM12-16-01	
25mm M12 lens	LM12-25-01	
Illumination accessory with white LED ring light, cover and hex wrench	ISLM-7000-WHI	
Illumination accessory with cover and hex wrench. Does not include an LED ring light.	ISLM-7000-00	
Diffuse cover	COV-7000-DF	
Clear cover	COV-7000-CLR	
Polarized cover	COV-7000-PL-FULL	
Note: When installing the cover, pull the red tab to remove the protective film.		



Accessory	Part Number	Accessory Image
Red LED ring light	ISL-7000-RD	
IR LED ring light	ISL-7000-IR	
Blue LED ring light	ISL-7000-BL	
White LED ring light	ISL-7000-WHI	
<p>Note: For color vision systems, the white LED ring light should be used.</p>		
Red bandpass filter used with the ISL-7000-RD LED ring light	ISF-7000-RDBP605	
IR bandpass filter used with the ISL-7000-IR LED ring light	ISF-7000-IRBP815	
Blue bandpass filter used with the ISL-7000-BL LED ring light	ISF-7000-BLBP435	

S-Mount/M12 Manual Focus Accessories

Note:

- The following S-Mount/M12 lenses are supported. If a different lens is used, the following restrictions apply:
 - At infinity focus, the back focal length must be greater than 5.5mm.
 - Close up, the back focal length of the lens cannot be greater than 13mm.

- i**
- The DataMan clear cover accessory (DM300-CLCOV) is supported with In-Sight S-Mount/M12 manual focus lenses and provides an IP65 rating.
 - For the In-Sight D905, the S-Mount/M12 lens image circle size is smaller than the vision system's image sensor size, resulting in mechanical vignetting in the image when using any S-Mount/M12 lens. Therefore, S-Mount/M12 lenses are not recommended. For more information, see [Mechanical Vignetting on page 81](#).

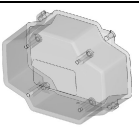
Accessory	Part Number	Accessory Image
6mm M12 lens	LM12-06-01	
8mm M12 lens	LM12-08-01-F2.2	
12mm M12 lens	LM12-12-01-F2.3	
16mm M12 lens	LM12-16-01	
25mm M12 lens	LM12-25-01	
<p>S-Mount/M12 adapter kit:</p> <ul style="list-style-type: none"> S-Mount/M12 adapter 13mm lens locking cone (P/N 1000000178) 14mm lens locking cone (P/N 372-1270R) Installation tool 	ISLN-7000-SMNT	
<p>Note: The S-Mount/M12 adapter kit (ISLN-7000-SMNT) is required when installing In-Sight S-Mount/M12 manual focus lenses.</p>		
Clear cover	DM300-CLCOV	

External Lights

External lights can be connected to the vision system's LIGHT connector using the External Light cable.

Note:

- The vision system supports connecting an integrated illumination accessory to the vision system's faceplate and connecting an external light to the vision system's LIGHT connector, but does not support using both lighting devices simultaneously.
- If daisy-chaining multiple Cognex IVSL-YLW2X-xxx or IVSL-YLW300-xxx external lights:
 - The lights must be powered externally by a separate power supply.
 - A Cognex control cable (CCB-FOV25-MAL-012) can be used to connect the vision system's LIGHT connector to the external light and a Cognex power cable (IVSL-5PM12-5) can be used to connect the light to the separate power supply. Only the power and ground wires from the Cognex power cable (IVSL-5PM12-5) should be connected to the remote power supply.
- ① If using a Cognex IVSL-LX520-xxx external light:
 - The lights must be powered externally by a separate power supply.
 - A Cognex control cable (CCB-FOV25-MAL-012) can be used to connect the vision system's LIGHT connector to the external light and a Cognex power cable (IVSL-5PM12-5) can be used to connect the light to the separate power supply. Only the power and ground wires from the Cognex power cable (IVSL-5PM12-5) should be connected to the remote power supply.
 - The following cables must not be used with IVSL-LX520-xxx external lights: IVSL-5PM12-J300, IVSL-5PM12-J500 and IVS-5PM12-J1000, IVSL-5PM12-J2000.
- The vision system supports Cognex IVSL-YL300-xx external lights with the following External Light cables: IVSL-M12-NSB-300, IVSL-M12-NSB-1000 and IVSL-M12-NSB-2000.

Accessory	Part Number	Supported External Light Cables	Accessory Image
Brick light, narrow blue	IVSL-ODDM-S75-470	IVSL-5PM12-J300 IVSL-5PM12-J500 IVSL-5PM12-J1000 IVSL-5PM12-J2000	
Brick light, narrow red	IVSL-ODDM-S75-625	IVSL-5PM12-J300 IVSL-5PM12-J500 IVSL-5PM12-J1000 IVSL-5PM12-J2000	

Accessory	Part Number	Supported External Light Cables	Accessory Image
Bar light, wide red	IVSL-YLW2X-625	IVSL-5PM12-J300 IVSL-5PM12-J500 IVSL-5PM12-J1000 IVSL-5PM12-J2000	
Bar light, narrow red, linear polarizer	IVSL-YLW2X-625P	IVSL-5PM12-J300 IVSL-5PM12-J500 IVSL-5PM12-J1000 IVSL-5PM12-J2000	
Bar light, narrow infrared	IVSL-YLW2X-850	IVSL-5PM12-J300 IVSL-5PM12-J500 IVSL-5PM12-J1000 IVSL-5PM12-J2000	
Bar light, narrow blue	IVSL-YLW300-470	IVSL-5PM12-J300 IVSL-5PM12-J500 IVSL-5PM12-J1000 IVSL-5PM12-J2000	
Bar light, wide blue	IVSL-YLW300-470 W	IVSL-5PM12-J300 IVSL-5PM12-J500 IVSL-5PM12-J1000 IVSL-5PM12-J2000	
Bar light, narrow red	IVSL-YLW300-625	IVSL-5PM12-J300 IVSL-5PM12-J500 IVSL-5PM12-J1000 IVSL-5PM12-J2000	
Bar light, wide red	IVSL-YLW300-625 W	IVSL-5PM12-J300 IVSL-5PM12-J500 IVSL-5PM12-J1000 IVSL-5PM12-J2000	
Bar light, narrow white	IVSL-YLW300-WHI	IVSL-5PM12-J300 IVSL-5PM12-J500 IVSL-5PM12-J1000 IVSL-5PM12-J2000	
Bar light, wide white	IVSL-YLW300-WHI W	IVSL-5PM12-J300 IVSL-5PM12-J500 IVSL-5PM12-J1000 IVSL-5PM12-J2000	
Bar light, blue	IVSL-LX520-470	CCB-FOV25-MAL-012 for intensity and strobe control. IVSL-5PM12-5 for power.	
Bar light, red	IVSL-LX520-625	CCB-FOV25-MAL-012 for intensity and strobe control. IVSL-5PM12-5 for power.	

Cables

Note:



- If using an integrated or external illumination accessory, the 10 meter and 15 meter Breakout cables are not supported.
- When using the 15 meter Breakout cable, full 24VDC voltage must be maintained at the input leads of the Breakout cable when the vision system is operating.

Accessory	Part Number	Accessory Image
External Light Cable, Yellow Note: This cable supports intensity control.	IVSL-5PM12-J300 IVSL-5PM12-J500 IVSL-5PM12-J1000 IVSL-5PM12-J2000	
External Light Cable, Black Note: <ul style="list-style-type: none"> • This cable supports intensity control. • This cable is used with standard SVL lights. 	IVSL-M12-NSB-300 IVSL-M12-NSB-1000 IVSL-M12-NSB-2000	
External Light Cable, Grey Note: This cable does not support intensity control.	CCB-M12LTF-xx (xx specifies length: 0.5m, 1m, 2m, 5m)	
Ethernet Cable, X-coded M12-8 to RJ-45	CCB-84901-2001-xx (straight, xx specifies length: 2m, 5m, 10m, 15m, 30m)	
Ethernet Cable, X-coded M12-8 to RJ-45	CCB-84901-2002-xx (right-angled, xx specifies length: 2m, 5m, 10m)	
Ethernet Cable, Robotic X-Coded M12-8 to RJ-45	CCB-84901-2RBT-xx (straight, xx specifies length: 2m, 5m, 10m)	
Breakout Cable, M12-12 to Flying Lead	CCB-PWRIO- xx (straight, xx specifies length: 5m, 10m, 15m)	
Breakout Cable, M12-12 to Flying Lead	CCB-PWRIO-xxR (right-angled, xx specifies length: 5m, 10m, 15m)	

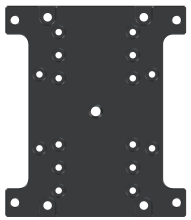
Mounting Brackets

Accessory	Part Number	Accessory Image
<p>Mounting bracket with M3, M4 and 1/4 - 20 mounting holes. Mounting screws are not included. The mounting bracket is supported with In-Sight 5000 series, In-Sight 7000 Gen2 series, In-Sight 9000 series and In-Sight D900 series vision systems.</p>	BKT-INS-01	

Power Supplies

Accessory	Part Number	Accessory Image
<p>DIN rail power supply that converts AC mains power to 24VDC.</p>	ACC-Quint-PS	

Connectors and Indicators



Connector	Function
PWR Connector	Connects the Breakout cable, which provides connections to an external power supply, the acquisition trigger input, general-purpose inputs and high-speed outputs. For more information, refer to Breakout Cable on page 70 .
LIGHT Connector	Connects the vision system to an external lighting device. For more information, refer to External Light Connector on page 68 .
ENET Connector	Connects the Ethernet cable, which provides 10/100/1000 Ethernet connectivity. For more information, refer to Ethernet Cable on page 69 .



Indicator	Function
	Focus Metric LEDs Not supported.
	TRIG Button Not supported.
	Power LED The green LED illuminates to indicate that the vision system is powered on.
	SD Card Status LED <ul style="list-style-type: none"> Off: The SD card is not inserted. Green: The SD card is present, and it is safe to remove the SD card after removing power from the vision system. Yellow: The SD card is present, but it is not safe to remove it.
	Pass/Fail LED and Indicator Ring Green or red when active. User configurable.
	Network LED The yellow LED flashes to indicate network activity.
	Error LED Red when active. User configurable.
	TUNE Button Not supported.

Installation

Read this section to learn how the vision system connects to its standard components and accessories. For a list of options and accessories, contact your Cognex sales representative.

Note: Cables are sold separately.

CAUTION: All cable connectors are keyed to fit the connectors on the vision system. Do not force the connections or damage may occur.

Install the Lens, Lighting and Cover

You can choose between a variety of different C-Mount and S-Mount/M12 lenses and covers to install to the vision system. Refer to [In-Sight Lenses, Lights and Covers on page 10](#) for a complete list of options and accessories.

Install the C-Mount Lens and Cover (COV-7000-CMNT or COV-7000-CMNT-EX)

Complete the following steps to install a C-Mount lens and cover to the vision system. The C-Mount covers are optional accessories and required for IP67 protection.

Note:

- When using a C-Mount lens, the following restrictions apply:
 - Maximum thread length is 5.25mm.
 - The C-Mount lens threads and body cannot protrude more than 6.5mm in length into the vision system when screwed in unless the diameter of the back lens is smaller than 14.75mm. If the C-Mount lens threads and body protrude more than 6.5mm, you can add a spacer between the lens and vision system. However, the spacer decreases the working distance.
- If using the COV-7000-CMNT cover, the maximum lens length is 41mm, the maximum lens body diameter is 36.5mm and the maximum diameter including locking screws is 47mm.
- If using the COV-7000-CMNT-EX cover, the maximum lens length is 62mm, the maximum lens body diameter is 36.5mm and the maximum diameter including locking screws is 46.5mm.

CAUTION: If installing a C-Mount cover, the illumination accessory (ISLM-7000-xxx) PCB should not be installed to the vision system. Refer to [Remove the Illumination Accessory PCB on page 82](#) for steps to safely remove the PCB and avoid damage to the vision system.

1. Remove the rubber faceplate covering the image sensor window, if present.
2. Remove the protective film covering the threaded lens opening, if present.
3. Place the adapter on the faceplate of the vision system. Insert the four adapter screws and tighten. The maximum torque is 0.90 Nm (8 in-lb).
4. Thread the lens into the vision system.

5. Attach the cover to the vision system. Rotate the cover clockwise approximately seven degrees to lock it.

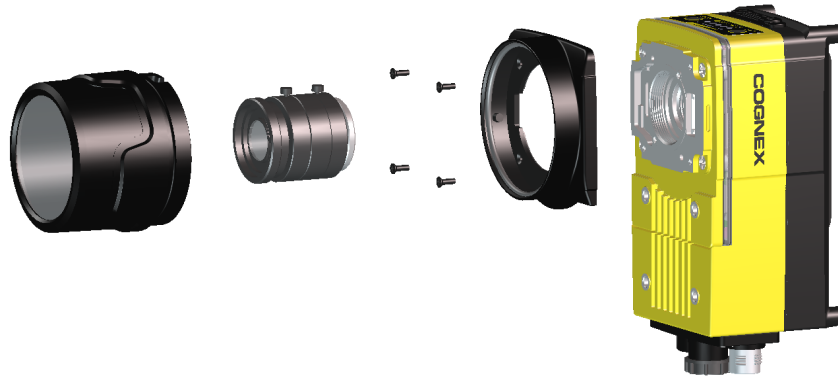

Install the C-Mount Lens and Cover (COV-7000-CMNT-LG)

Complete the following steps to install a C-Mount lens and cover to the vision system. The C-Mount cover is an optional accessory and required for IP67 protection.

Note:

- When using a C-Mount lens, the following restrictions apply:
 - Maximum thread length is 5.25mm.
 - The C-Mount lens threads and body cannot protrude more than 6.5mm in length into the vision system when screwed in unless the diameter of the back lens is smaller than 14.75mm. If the C-Mount lens threads and body protrude more than 6.5mm, you can add a spacer between the lens and vision system. However, the spacer decreases the working distance.
- If using the COV-7000-CMNT-LG cover, the maximum lens length is 77mm, the maximum lens body diameter is 55mm and the maximum diameter including locking screws is 55mm.

CAUTION: If installing a C-Mount cover, the illumination accessory (ISLM-7000-xxx) PCB should not be installed to the vision system. Refer to [Remove the Illumination Accessory PCB on page 82](#) for steps to safely remove the PCB and avoid damage to the vision system.

1. Remove the rubber faceplate covering the image sensor window, if present.
2. Remove the protective film covering the threaded lens opening, if present.
3. Place the adapter on the faceplate of the vision system. Insert the four adapter screws and tighten. The maximum torque is 0.90 Nm (8 in-lb).
4. Thread the lens into the vision system.
5. (Optional) For longer lenses, the C-Mount cover extender accessory (COV-7000-CMNT-LGX) can be used to add 30mm in length to the C-Mount cover. If using the cover extender, attach it to the vision system and rotate the cover extender clockwise approximately thirteen degrees to lock it.
6. Attach the cover to the vision system. Rotate the cover clockwise approximately thirteen degrees to lock it.



Install the C-Mount Lens and In-Sight Illumination

Complete the following steps to install a C-Mount lens and the illumination accessory (ISLM-7000-WHI). The illumination accessory (ISLM-7000-WHI) is an optional accessory and required for IP67 protection.

Note: The vision system supports connecting an integrated illumination accessory to the vision system's faceplate and connecting an external light to the vision system's LIGHT connector, but does not support using both lighting devices simultaneously.

CAUTION:

- Refer to [C-Mount Illumination Accessories on page 12](#) for lenses supported with the illumination accessory (ISLM-7000-WHI). If using a different C-Mount lens with the illumination accessory, it must be 29.5mm in diameter or smaller. Maximum lens length is 38.5mm without a bandpass filter and 36mm with a bandpass filter. Larger lenses will irreparably damage the vision system.
- Do not hot-plug the illumination accessory. Verify the vision system is not receiving power when connecting or disconnecting the illumination accessory. Failure to remove power during this procedure may result in damage to the vision system and/or the illumination accessory.
- The vision system should be grounded, either by mounting the vision system to a fixture that is electrically grounded or by attaching a wire from the vision system's mounting fixture to frame ground or Earth ground. If a ground wire is used, it should be attached to one of the four mounting points on the back plate of the vision system and not to the mounting points on the front of the vision system.
- Tighten all illumination accessory screws in the following sequence.

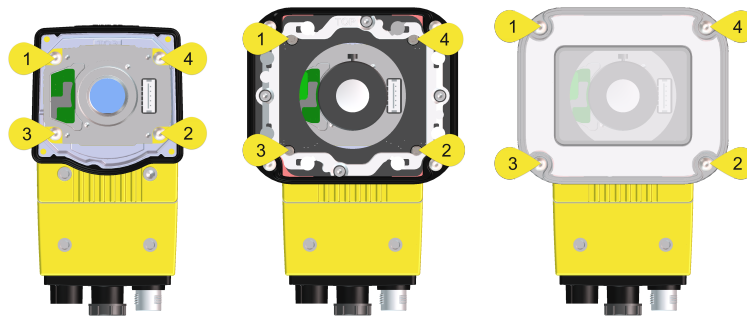

- Remove the rubber faceplate covering the image sensor window, if present.
- Remove the protective film covering the threaded lens opening, if present.

3. Plug the PCB into the lighting connector on the vision system faceplate.

CAUTION: If uninstalling the PCB from the vision system, refer to [Remove the Illumination Accessory PCB on page 82](#) for steps to safely remove the PCB and avoid damage to the vision system.

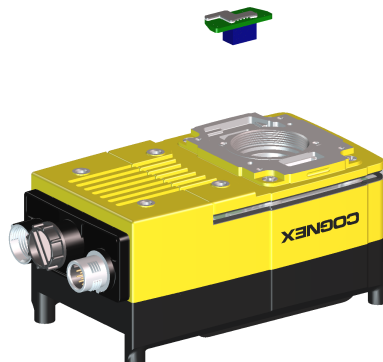

4. Install the spacer.

- a. Place the spacer on top of the vision system with "TOP" oriented upward.
- b. Verify seating of the gasket on the bottom of the spacer.
- c. Insert the four M3 screws and use a 2mm hex wrench to torque screws to 0.34 Nm (3 in-lb). For the D902, use the M3 x 6mm screws. For the D905, use the M3 x 8mm screws.

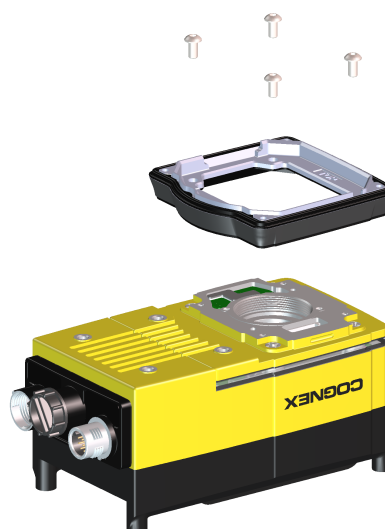

5. Thread the lens into the vision system. Focusing of the C-Mount lens prior to light housing installation is required.

Note: If installing the autofocus module accessory (ISAF-7000-8mm), refer to [Install the Autofocus Module and In-Sight Illumination on page 29](#).



6. Install the light housing.

CAUTION:



- Do not hot-plug the LED ring light. Verify the vision system is not receiving power when connecting or disconnecting the LED ring light.
- A connector protrudes from the underside of the light housing. To prevent damage, it is recommended the light housing not be removed from the box until ready to be assembled.

Note: If a different LED color is required, refer to [Replace the LED Ring Light \(Optional\) on page 44](#).

- Place the light housing with LED ring light on top of the spacer, with "TOP" oriented upward.
- Verify seating of the gasket on the top of the spacer.
- There are four captive screw access holes near the white circles on the LED ring light. Use a 2mm hex wrench to torque the captive screws to 0.34 Nm (3 in-lb).



7. Optionally, install a bandpass filter to the light baffle.

 **Tip:** Wear gloves when installing the filter to prevent leaving fingerprints on the surface of the filter.

- a. Insert the filter in the light baffle so it is held in place between the light baffle's filter retention tabs. Both sides of the filter are the same; either side of the filter can be oriented up or down when inserted in the light baffle.



- b. Push the filter down and snap it into place, ensuring the filter retention tabs are flush with the top surface of the filter.

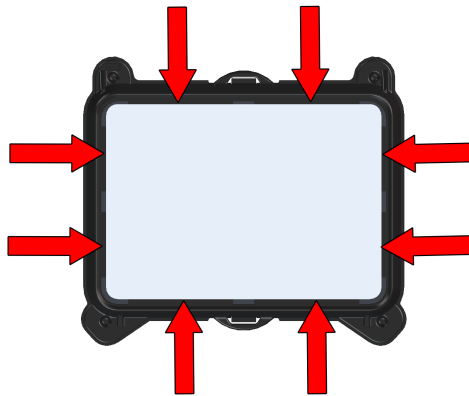

8. Install the light baffle.

- a. Tilt the light baffle toward the light housing and maneuver the light baffle past the top of the LED ring light structure.
- b. Compress the light baffle and maneuver the bottom of the light baffle past the bottom of the LED ring light structure until the light baffle snaps into place, with the keyed tabs sitting flush over each light housing captive screw access hole.

**9. Install the cover.**

- a. Place the cover on the light housing.
- b. Align the central clear region of the cover with the light baffle edges.
- c. Insert the four M3 x 12mm screws and use a 2mm hex wrench to torque screws to 0.31 Nm (2.75 in-lb).

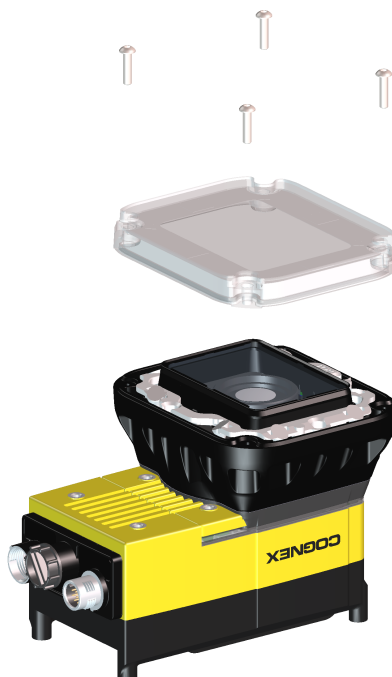

Install the Autofocus Module and In-Sight Illumination

Complete the following steps to install the autofocus module accessory (ISAF-7000-8mm) and illumination accessory (ISLM-7000-WHI).

Note:

- The autofocus module has an 8mm M12 lens pre-installed. If a different lens is required, it should be installed into the autofocus module before the autofocus module is installed to the vision system. For more information, see [Replace the M12 Autofocus Lens \(Optional\) on page 49](#).
- For the In-Sight D905, the S-Mount/M12 lens image circle size is smaller than the vision system's image sensor size, resulting in mechanical vignetting in the image when using any S-Mount/M12 lens. Therefore, S-Mount/M12 lenses are not recommended. For more information, see [Mechanical Vignetting on page 81](#).
- The illumination accessory (ISLM-7000-xxx) is sold separately. It is the only cover available for the autofocus module and is required for IP67 rating.
- The vision system supports connecting an integrated illumination accessory to the vision system's faceplate and connecting an external light to the vision system's LIGHT connector, but does not support using both lighting devices simultaneously.

CAUTION:

- When installing the illumination accessory (ISLM-7000-WHI):
 - Do not hot-plug the illumination accessory. Verify the vision system is not receiving power when connecting or disconnecting the illumination accessory. Failure to remove power during this procedure may result in damage to the vision system and/or the illumination accessory.
 - The vision system should be grounded, either by mounting the vision system to a fixture that is electrically grounded or by attaching a wire from the vision system's mounting fixture to frame ground or Earth ground. If a ground wire is used, it should be attached to one of the four mounting points on the back plate of the vision system and not to the mounting points on the front of the vision system.
- Tighten all illumination accessory screws in the following sequence.

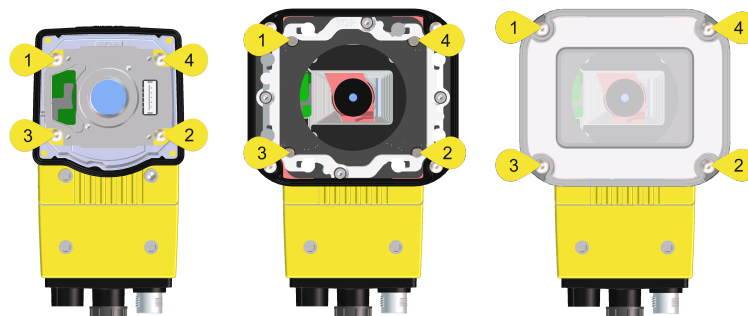

1. Remove the rubber faceplate covering the image sensor window, if present.
2. Remove the protective film covering the threaded lens opening, if present.

3. Plug the PCB into the lighting connector on the vision system faceplate.

CAUTION: If uninstalling the PCB from the vision system, refer to [Remove the Illumination Accessory PCB on page 82](#) for steps to safely remove the PCB and avoid damage to the vision system.

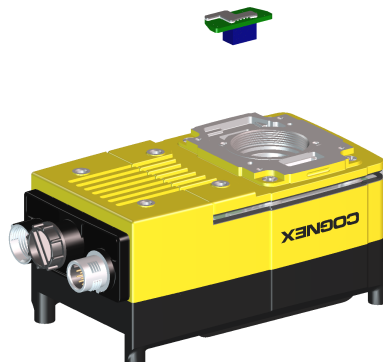

4. Install the spacer.

- a. Place the spacer on top of the vision system with "TOP" oriented upward.
- b. Verify seating of the gasket on the bottom of the spacer.
- c. Insert the four M3 screws and use a 2mm hex wrench to torque screws to 0.34 Nm (3 in-lb). For the D902, use the M3 x 6mm screws. For the D905, use the M3 x 8mm screws.

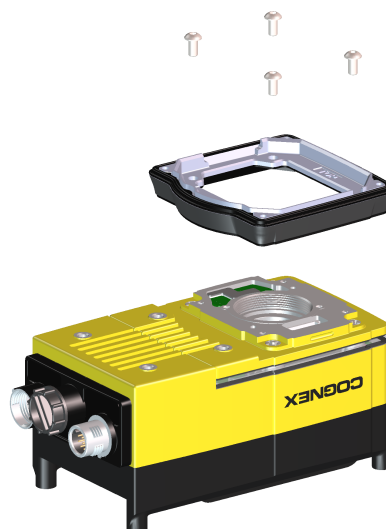

5. Install the autofocus module.

CAUTION: Do not hot-plug the autofocus module. Verify the vision system is not receiving power when connecting or disconnecting the autofocus module.

Note: If a different lens is required, it should be installed in the autofocus module before the autofocus module is installed to the vision system. For more information, see [Replace the M12 Autofocus Lens \(Optional\) on page 49](#).

- a. There are two alignment pins on the base of the autofocus module. Seat the pins into the vision system faceplate.
- b. There are three captive screws in the autofocus module. Partially thread the screws into the vision system faceplate using a 1.5mm hex wrench.
- c. Once threaded, torque the captive screws to 0.5 Nm (4.43 in-lb) using a torque screwdriver with a 1.5mm hex torque bit capable of reaching 15mm into a 2.5mm diameter hole. For example, Wiha Tools 1.5mm Hex Metric Torque Blade (SKU 28545) used with the Adjustable Torque Handle (SKU 28550).



6. Install the light housing.

CAUTION:

- Do not hot-plug the LED ring light. Verify the vision system is not receiving power when connecting or disconnecting the LED ring light.
- A connector protrudes from the underside of the light housing. To prevent damage, it is recommended the light housing not be removed from the box until ready to be assembled.

Note: If a different LED color is required, refer to [Replace the LED Ring Light \(Optional\) on page 44](#).

- a. Place the light housing with LED ring light on top of the spacer, with "TOP" oriented upward.
- b. Verify seating of the gasket on the top of the spacer.
- c. There are four captive screw access holes near the white circles on the LED ring light. Use a 2mm hex wrench to torque the captive screws to 0.34 Nm (3 in-lb).



7. Optionally, install a bandpass filter to the light baffle.



Tip: Wear gloves when installing the filter to prevent leaving fingerprints on the surface of the filter.

- a. Insert the filter in the light baffle so it is held in place between the light baffle's filter retention tabs. Both sides of the filter are the same; either side of the filter can be oriented up or down when inserted in the light baffle.



- b. Push the filter down and snap it into place, ensuring the filter retention tabs are flush with the top surface of the filter.

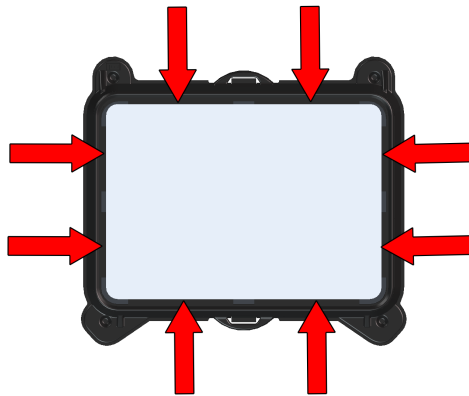

8. Install the light baffle.

- a. Tilt the light baffle toward the light housing and maneuver the light baffle past the top of the LED ring light structure.
- b. Compress the light baffle and maneuver the bottom of the light baffle past the bottom of the LED ring light structure until the light baffle snaps into place, with the keyed tabs sitting flush over each light housing captive screw access hole.



9. Install the cover.

- a. Place the cover on the light housing.
- b. Align the central clear region of the cover with the light baffle edges.
- c. Insert the four M3 x 12mm screws and use a 2mm hex wrench to torque screws to 0.31 Nm (2.75 in-lb).

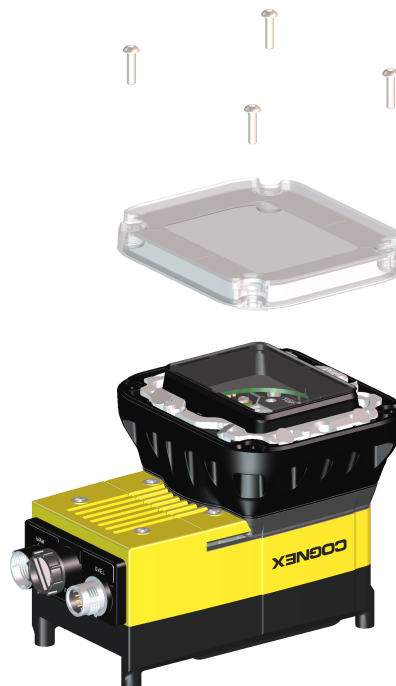

Install the S-Mount/M12 Manual Focus Lens

Complete the following steps to install an In-Sight S-Mount/M12 manual focus lens. The S-Mount/M12 adapter kit (ISLN-7000-SMNT) is required when installing In-Sight S-Mount/M12 manual focus lenses.

Note:

- The DataMan clear cover accessory (DM300-CLCOV) is supported with In-Sight S-Mount/M12 manual focus lenses and provides an IP65 rating.
- For the In-Sight D905, the S-Mount/M12 lens image circle size is smaller than the vision system's image sensor size, resulting in mechanical vignetting in the image when using any S-Mount/M12 lens. Therefore, S-Mount/M12 lenses are not recommended. For more information, see [Mechanical Vignetting on page 81](#).

1. Remove the rubber faceplate covering the image sensor window, if present.
2. Remove the protective film covering the threaded lens opening, if present.
3. Place the S-Mount adapter over the image sensor window.



4. Place the "In-Sight" end of the adapter tool on the adapter. Turn clockwise until tight.



5. Remove the adapter tool.

6. Thread the lens into the vision system. Focusing of lens prior to installation of the rubber lens-locking cone is required.



7. Place the 13mm or 14mm rubber lens-locking cone over the M12 lens until it snaps tightly into place around the nose of the lens. When installing, avoid rotating the M12 lens.



8. If using a lens cover accessory, attach the cover to the vision system.

Working Distance and Field of View (S-Mount/M12 Lenses)

The working distance is the distance from the In-Sight illumination accessory cover (ISLM-7000-xxx) to the part that needs to be inspected. Field of view is what the vision system can see at that distance. As the working distance increases, so does the size of the field of view.

Note:

- The following charts show the design field of view of the In-Sight S-Mount/M12 accessory lenses and is fully mapped onto the image sensor. Additional field beyond the design field of view may have vignetting. For supported In-Sight lenses, refer to [S-Mount/M12 Autofocus Accessories on page 14](#) and [S-Mount/M12 Manual Focus Accessories on page 15](#).
- For the In-Sight D902, the S-Mount/M12 lens image circle size is slightly smaller than the vision system's image sensor size, resulting in mechanical vignetting in the image. This is most noticeable with the smaller S-Mount/M12 6mm, 8mm and 12mm focal lenses.
- For the In-Sight D905, the S-Mount/M12 lens image circle size is smaller than the vision system's image sensor size, resulting in mechanical vignetting in the image when using any S-Mount/M12 lens. Therefore, S-Mount/M12 lenses are not recommended. For more information, see [Mechanical Vignetting on page 81](#).

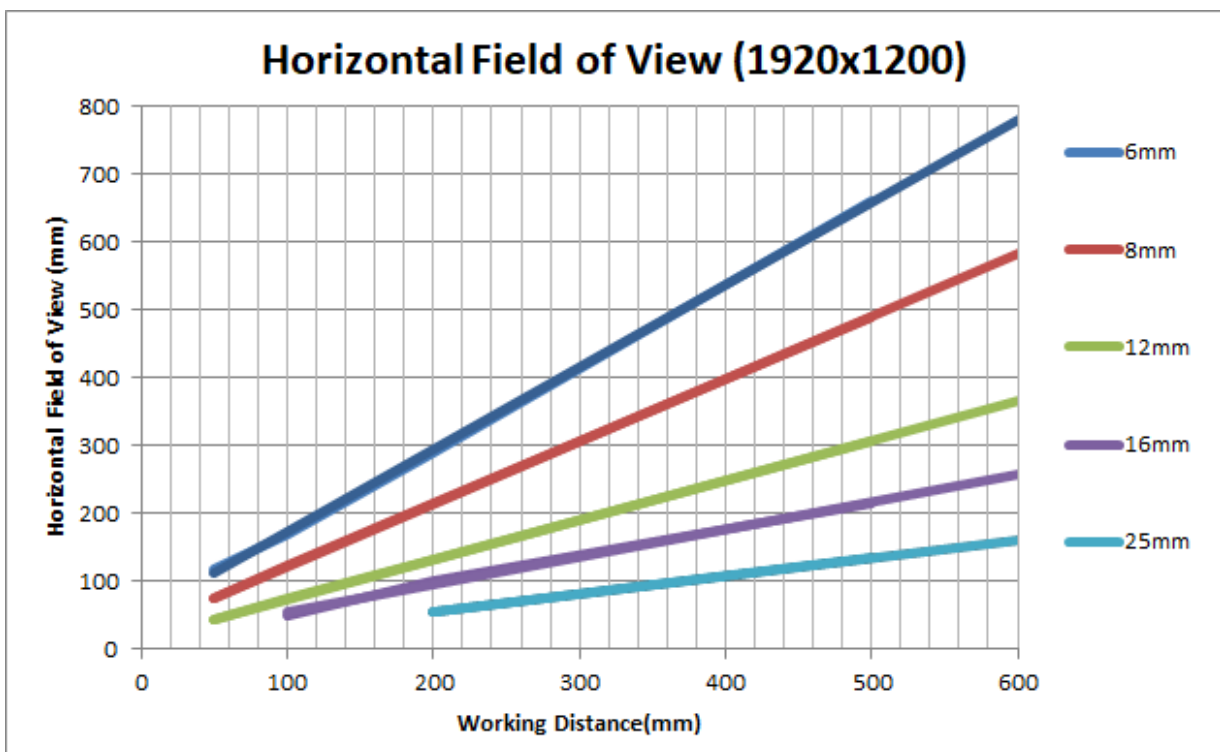

Mount the Vision System

The vision system provides mounting holes for attachment to a mounting surface.

Note:

- In the rear housing, the maximum insertion depth of the M4 screws should not exceed 8mm. This does not include the thickness of the mounting material used.
- In the front housing, the maximum insertion depth of the M4 screws closest to the lens should not exceed 3mm and the M4 screws closest to the connectors should not exceed 4.5mm. This does not include the thickness of the mounting material used.

For more information, see [D902 Vision System on page 71](#) and [D905 Vision System on page 72](#).

CAUTION: The vision system should be grounded, either by mounting the vision system to a fixture that is electrically grounded or by attaching a wire from the vision system's mounting fixture to frame ground or Earth ground. If a ground wire is used, it should be attached to one of the four mounting points on the back plate of the vision system and not to the mounting points on the front of the vision system.

1. Align the holes on the mounting surface with the mounting holes on the vision system.
2. Insert the M4 screws into the mounting holes and tighten using a 2.5mm hex wrench. The maximum torque is 0.90 Nm (8 in-lb).

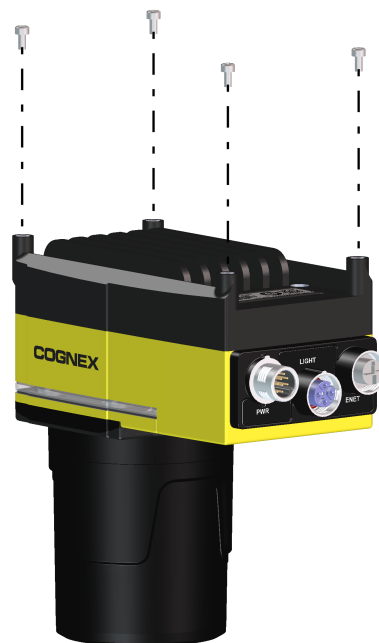

Install the Mounting Bracket (BKT-INS-01)

Complete the following steps to attach the accessory mounting bracket (BKT-INS-01) to the vision system.

Note:

- When attaching the vision system to the mounting bracket:
 - If using the M4 screw holes, the thread length of the M4 screw should not exceed 12mm.
 - If using the 1/4 - 20 screw holes, the thread length of the screw should not exceed 10mm.



For more information, see [Mounting Bracket \(BKT-INS-01\) on page 78](#).

CAUTION: The vision system should be grounded, either by mounting the vision system to a fixture that is electrically grounded or by attaching a wire from the vision system's mounting fixture to frame ground or Earth ground. If a ground wire is used, it should be attached to one of the four mounting points on the back plate of the vision system and not to the mounting points on the front of the vision system.



1. Align the mounting bracket with the mounting holes on the vision system.
2. Insert the M4 screws into the mounting holes and tighten. The maximum torque is 0.90 Nm (8 in-lb).



Connect the External Light Cable (Optional)

The vision system's LIGHT connector is used to connect the External Light cable to an external lighting device, providing power and strobe control. The External Light cable can be connected to either a continuous or strobed lighting device. For a list of supported accessories, refer to [External Lights on page 16](#).

Note: The vision system supports connecting an integrated illumination accessory to the vision system's faceplate and connecting an external light to the vision system's LIGHT connector, but does not support using both lighting devices simultaneously.

1. Remove the protective cap from the LIGHT connector, if present.
2. Connect the External Light cable's M12 connector to the vision system's LIGHT connector.
3. Connect the other end of the Light cable to an external lighting device (for example, a strobe light). For more information, refer to [External Light Connector on page 68](#).



Connect the Ethernet Cable

CAUTION: The Ethernet cable shield must be grounded at the far end. Whatever this cable is plugged into (typically a switch or router) should have a grounded Ethernet connector. A digital voltmeter should be used to validate the grounding. If the far end device is not grounded, a ground wire should be added in compliance with local electrical codes.

1. Connect the Ethernet cable's M12 connector to the vision system ENET connector.
2. Connect the Ethernet cable's RJ-45 connector to a switch/router or PC, as applicable.



Connect the Breakout Cable

⚠ CAUTION: To reduce emissions, connect the far end of the Breakout cable shield to frame ground.

Note:

- Perform wiring or adjustments to I/O devices when the vision system is not receiving power.
- You can cut exposed wires short or trim wire ends. You also can tie the wires back if you use a tie made of non-conductive material. Keep bare wires separated from the +24VDC wire.
- If using an integrated or external illumination accessory, the 10 meter and 15 meter Breakout cables are not supported.
- When using the 15 meter Breakout cable, full 24VDC voltage must be maintained at the input leads of the Breakout cable when the vision system is operating.

1. Verify that the 24VDC power supply is unplugged and not receiving power.
2. Optionally, connect the I/O wires to an appropriate device (for example, a PLC or a trigger sensor). For more information, refer to [Breakout Cable on page 70](#).
3. Attach the Breakout cable's +24VDC (Red wire) and GND (Black wire) to the corresponding terminals on the power supply.

⚠ CAUTION: Never connect voltages other than 24VDC. Always observe the polarity shown.

4. Connect the Breakout cable's M12 connector to the vision system PWR connector.



5. Restore power to the 24VDC power supply and turn it on if necessary.

Replace the SD Card (Optional)

The vision system is equipped with a Micro SD card slot and an 8GB SD card is pre-installed for saving job and image files. Complete the following steps to replace the pre-installed SD card.

Note:

- The vision system supports:



- SDHC cards with a maximum capacity of 32GB, formatted with a FAT32 file system.
- SDXC cards with a maximum capacity of 512GB, formatted with a FAT32 file system.
- Speed classes 2, 4, 6 and 10.

CAUTION:



- Hot-plugging the SD card is not supported and may damage the SD card and/or lead to unexpected behavior.
- IP67 protection requires that all cables are properly attached (or the provided connector plug installed), the IP67-rated lens cover is properly installed and the Micro SD card cover is fastened in place.
- Observe ESD precautions when installing or removing an SD card or other accessories.

1. Remove power from the vision system.
2. Unscrew the screws in the Micro SD card cover and open the card slot.
3. Remove the existing SD card from the Micro SD card slot.
4. Insert the new SD card into the Micro SD card slot, ensuring the card is properly oriented.
5. Replace the SD card cover, reinsert the screws and torque screws to 0.18 Nm (25 in-oz).



6. Restore power to the vision system.

Replace the LED Ring Light (Optional)

The illumination accessory (ISLM-7000-WHI) has a white LED ring light pre-installed. Complete the following steps to replace the pre-installed LED ring light.

CAUTION:

- Do not hot-plug the illumination accessory. Verify the vision system is not receiving power when connecting or disconnecting the illumination accessory. Failure to remove power during this procedure may result in damage to the vision system and/or the illumination accessory.
- Tighten all illumination accessory screws in the following sequence.

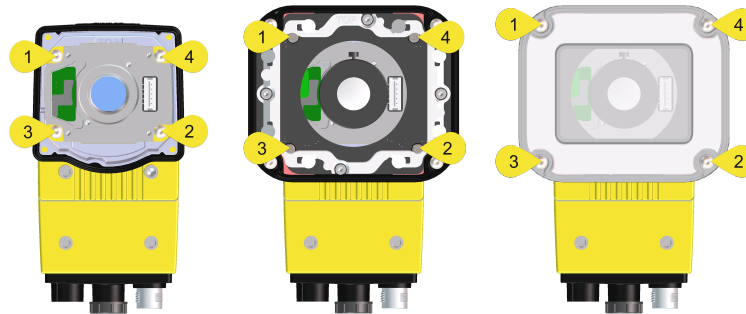

1. Remove power from the vision system.
2. Use a 2mm hex wrench to remove the four M3 x 12mm screws and remove the cover.

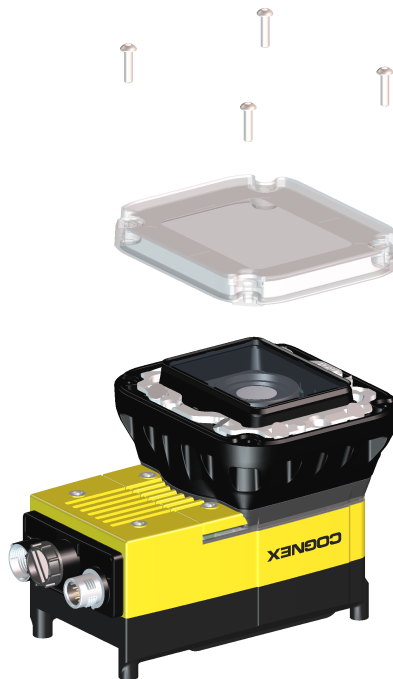

3. Remove the keyed light baffle.

Note: This step includes an optional bandpass filter accessory installed to the light baffle. For more information, refer to [In-Sight Lenses, Lights and Covers on page 10](#).



4. The LED ring light screw holes are indicated by a triangle symbol ▶. Use a 2mm hex wrench to remove the four M2.5 x 6mm screws and remove the LED ring light from the light housing.

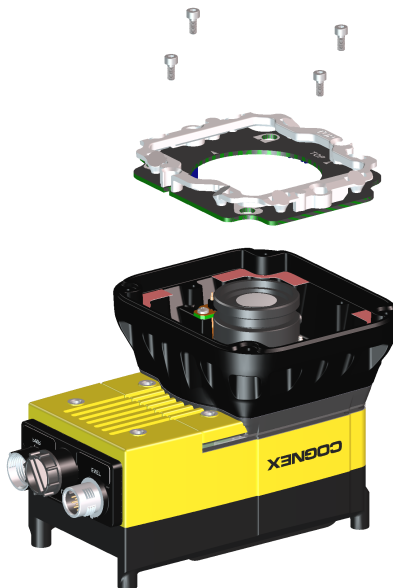

5. Install the new LED ring light.

CAUTION: Do not hot-plug the LED ring light. Verify the vision system is not receiving power when connecting or disconnecting the LED ring light.

- Place the new LED ring light inside the light housing, with "TOP" oriented upward.
- Insert the four M2.5 x 6mm screws into the screw holes indicated by a triangle symbol ►.
- Tighten the screws using a 2mm hex wrench. The maximum torque is 0.34 Nm (3 in-lb).



6. Install the light baffle.

- a. Tilt the light baffle toward the light housing and maneuver the light baffle past the top of the LED ring light structure.
- b. Compress the light baffle and maneuver the bottom of the light baffle past the bottom of the LED ring light structure until the light baffle snaps into place, with the keyed tabs sitting flush over each light housing captive screw access hole.

i **Note:** This step includes an optional bandpass filter accessory installed to the light baffle. For more information, refer to [In-Sight Lenses, Lights and Covers on page 10](#).



7. Install the cover.

- a. Place the cover on the light housing.
- b. Align the central clear region of the cover with the light baffle edges.
- c. Insert the four M3 x 12mm screws and use a 2mm hex wrench to torque screws to 0.31 Nm (2.75 in-lb).

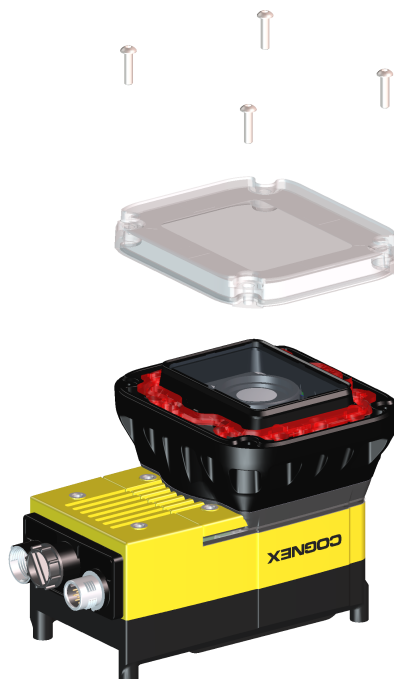

8. Restore power to the vision system.

Replace the M12 Autofocus Lens (Optional)

The autofocus module accessory (ISAF-7000-8mm) has an 8mm M12 lens pre-installed. Complete the following steps to replace the pre-installed M12 lens.

Note: For the In-Sight D905, the S-Mount/M12 lens image circle size is smaller than the vision system's image sensor size, resulting in mechanical vignetting in the image when using any S-Mount/M12 lens. Therefore, S-Mount/M12 lenses are not recommended. For more information, see [Mechanical Vignetting on page 81](#).

CAUTION:

- Do not hot-plug the illumination accessory. Verify the vision system is not receiving power when connecting or disconnecting the illumination accessory. Failure to remove power during this procedure may result in damage to the vision system and/or the illumination accessory.
- Tighten all illumination accessory screws in the following sequence.

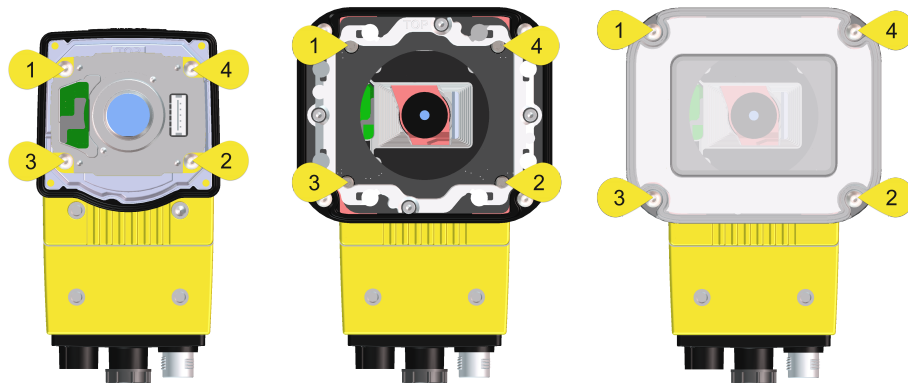

1. If the autofocus module is already installed to the vision system, you must first log onto the vision system using In-Sight Vision Suite software and reset the focus position to 100. For more information, see the *In-Sight® ViDi Help* file.
2. Remove power from the vision system.

- Use a 2mm hex wrench to remove the four M3 x 12mm screws and remove the cover.



- Remove the keyed light baffle.

Note: This step includes an optional bandpass filter accessory installed to the light baffle. For more information, refer to [In-Sight Lenses, Lights and Covers on page 10](#).



- The light housing contains four captive screws that are accessible via captive screw access holes in the LED ring light board. Use a 2mm hex wrench to loosen the four captive screws and remove the light housing.

CAUTION:

- Do not hot-plug the LED ring light. Verify the vision system is not receiving power when connecting or disconnecting the LED ring light.
- A connector protrudes from the underside of the light housing and can be damaged if placed on a hard surface.



- Use a 1.5mm hex wrench to loosen the three captive screws in the autofocus module and remove the autofocus module from the vision system.



CAUTION: Do not hot-plug the autofocus module. Verify the vision system is not receiving power when connecting or disconnecting the autofocus module.

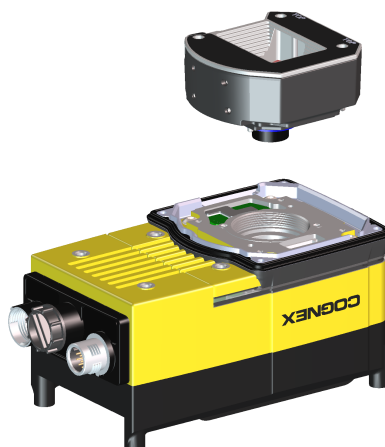

7. Remove the M12 lens from the autofocus module.

a. Remove the blue threaded lens nut on the underside of the autofocus module.

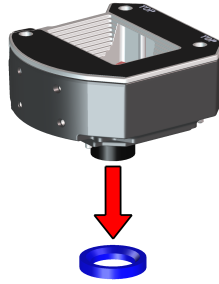

b. Remove the M12 lens from the autofocus module.

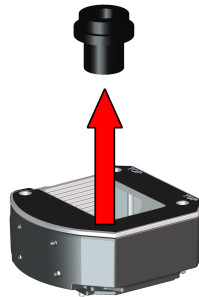

8. Install the new M12 lens.

- a. An extra black lens nut is included with the lens toolkit accessory (ISAF-7000-TOOL). Thread this black lens nut on the new M12 lens until snug.



- b. Drop the new M12 lens into the module.

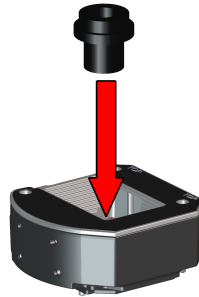

- c. Quarter-turn the thread of the lens clockwise, to ensure the lens is seated in the lens carrier.

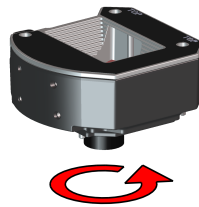

- d. Once the lens is in the module, place the lens tool directly on the lens, with the padded end of the tool pressed against the lens.

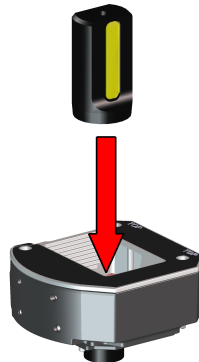

- e. With the lens tool, apply just enough pressure on the front of the lens to prevent the lens from moving. With the chamfer side of the blue lens nut facing the module, screw the blue nut onto the back of the lens. Once the threads of the blue nut are engaged with the lens, remove the lens tool and continue threading the blue nut until it is snug against the focus mechanism. The lens nut should be tight enough that it does not fall off due to vibration.

CAUTION: Use light axial force on the lens tool when installing or removing the lens.

Chamfer Side of Blue Lens Nut:

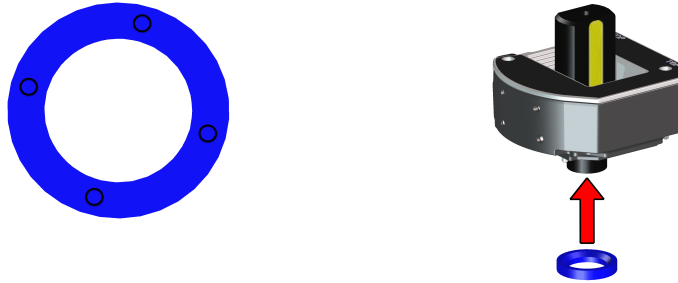

9. Install the autofocus module.

CAUTION: Do not hot-plug the autofocus module. Verify the vision system is not receiving power when connecting or disconnecting the autofocus module.

- There are two alignment pins on the base of the autofocus module. Seat the pins into the vision system faceplate.
- There are three captive screws in the autofocus module. Partially thread the screws into the vision system faceplate using a 1.5mm hex wrench.
- Once threaded, torque the captive screws to 0.5 Nm (4.43 in-lb) using a torque screwdriver with a 1.5mm hex torque bit capable of reaching 15mm into a 2.5mm diameter hole. For example, Wiha Tools 1.5mm Hex Metric Torque Blade (SKU 28545) used with the Adjustable Torque Handle (SKU 28550).

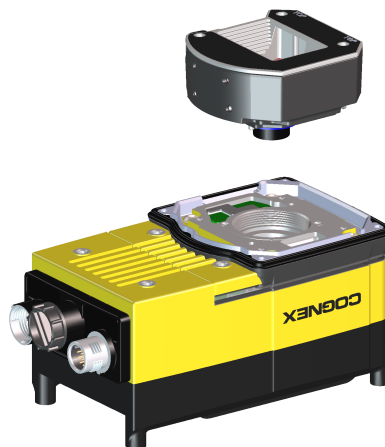

10. Install the light housing.

CAUTION:

- Do not hot-plug the LED ring light. Verify the vision system is not receiving power when connecting or disconnecting the LED ring light.
- A connector protrudes from the underside of the light housing and can be damaged if placed on a hard surface.

Note: If a different LED color is required, refer to [Replace the LED Ring Light \(Optional\) on page 44](#).

- a. Place the light housing with LED ring light on top of the spacer, with “TOP” oriented upward.
- b. Verify seating of the gasket on the top of the spacer.
- c. There are four captive screw access holes near the white circles on the LED ring light. Use a 2mm hex wrench to torque the captive screws to 0.34 Nm (3 in-lb).



11. Install the light baffle.

Note: This step includes an optional bandpass filter accessory installed to the light baffle. For more information, refer to [In-Sight Lenses, Lights and Covers on page 10](#).

- a. Tilt the light baffle toward the light housing and maneuver the light baffle past the top of the LED ring light structure.
- b. Compress the light baffle and maneuver the bottom of the light baffle past the bottom of the LED ring light structure until the light baffle snaps into place, with the keyed tabs sitting flush over each light housing captive screw access hole.



12. Install the cover.

- a. Place the cover on the light housing.
- b. Align the central clear region of the cover with the light baffle edges.
- c. Insert the four M3 x 12mm screws and use a 2mm hex wrench to torque screws to 0.31 Nm (2.75 in-lb).



13. Restore power to the vision system.

Specifications

The following sections list general specifications for the vision system.

D902 Vision System Specifications

Specifications	D902	D902C
Minimum Firmware Requirement	In-Sight version 2.2.0.	In-Sight version 2.3.0.
Job/Program Memory	16GB non-volatile flash memory; unlimited storage via remote network device.	
Image Processing Memory	3GB SDRAM	
SD Card	1 Micro SD card slot with an 8GB SD card pre-installed for saving job and image files. The vision system supports: <ul style="list-style-type: none"> • SDHC cards with a maximum capacity of 32GB, formatted with a FAT32 file system. • SDXC cards with a maximum capacity of 512GB, formatted with a FAT32 file system. • Speed classes 2, 4, 6 and 10. 	
Sensor Type	1/2.3-inch CMOS, global shutter	
Sensor Properties	7.9mm diagonal, 3.45 x 3.45µm sq. pixels	
Maximum Image Resolution (pixels)	1920 x 1200	
Electronic Shutter Speed	24µs to 1000ms	
Acquisition	Rapid reset, progressive scan, full-frame integration. High Dynamic Range (HDR+) available.	Rapid reset, progressive scan, full-frame integration.
Bit Depth	256 grey levels (8 bits/pixel)	24-bit color
Frames Per Second (FPS) ¹	51 FPS	34 FPS
Lens Type	C-Mount or S-Mount/M12	
Trigger	1 opto-isolated, acquisition trigger input.	
Discrete Inputs	3 general-purpose inputs when connected to the Breakout cable. ²	
Discrete Outputs	4 high-speed outputs when connected to the Breakout cable. ³	
Status LEDs	SD Card Status, Pass/Fail LED and Indicator Ring, Network LED and Error LED.	

¹ Maximum frames per second are job-dependent, based on the minimum exposure for a full image frame capture using the dedicated acquisition trigger, and assumes there is no user interface connection to the vision system.

² When connected to the Breakout cable, the vision system allows for bi-directional, general-purpose inputs and high-speed outputs for IN 2 / HSOUT 2 and IN 3 / HSOUT 3. These lines are configured as outputs by default.

³ When connected to the Breakout cable, the vision system allows for bi-directional, general-purpose inputs and high-speed outputs for IN 2 / HSOUT 2 and IN 3 / HSOUT 3. These lines are configured as outputs by default.

Specifications	D902	D902C
Internal LED Ring Light	White, Red, Blue or IR LED ring light used with the illumination accessory (ISLM-7000-xxx). <ul style="list-style-type: none"> • White LED color temperature: 4000 K • Red LED wavelength: 617 nm • Blue LED wavelength: 455 nm • IR LED wavelength: 850 nm 	
	Note: For color vision systems, the white LED ring light should be used.	
In-Sight Illumination Accessory (ISLM-7000-xxx)	Cover is compliant with ANSI Z87.1-2003 Drop-Ball Impact Test (no fracture, 25.4mm diameter steel ball, vertical drop from 127cm).	
In-Sight Autofocus Module Accessory (ISAF-7000-8mm)	Number of Focus Cycles: 20,000	
Network Communication	1 Ethernet port, 10/100/1000 BaseT with auto MDIX. IEEE 802.3 TCP/IP Protocol. Supports DHCP, static and link-local IP address configuration.	
Power Consumption	24VDC ±10%, 1.5A maximum.	
	Note: This product can have repetitive surges with high peak currents. A power source rated for at least 5A continuous current is required to supply these surges and prevent the product from operating unreliably.	
Power Output	24VDC @ 750mA maximum to external light.	
Material	Die-cast and extruded aluminum housing.	
Finish	Painted.	
Mounting	Four M4 threaded mounting holes on front and back of the vision system.	
Dimensions	<ul style="list-style-type: none"> • 53.4mm (2.10in) x 60.5mm (2.38in) x 121.0mm (4.77in). • 99.4mm (3.91in) x 60.5mm (2.38in) x 121.0mm (4.77in) with standard plastic C-Mount cover (COV-7000-CMNT). • 120.4mm (4.74in) x 60.5mm (2.38in) x 121.0mm (4.77in) with standard extended plastic C-Mount cover (COV-7000-CMNT-EX). • 135.7mm (5.34in) x 68.0mm (2.68in) x 121.0mm (4.77in) with wide plastic C-Mount cover (COV-7000-CMNT-LG). • 165.7 (6.52in) x 68.0mm (2.68in) x 121.0mm (4.77in) with wide plastic C-Mount cover (COV-7000-CMNT-LG) and wide plastic C-Mount extender (COV-7000-CMNT-LGX). • 95.1mm (3.74in) x 88.9mm (3.50in) x 121.0mm (4.77in) with Illumination (ISLM-7000-xxx). 	

Specifications	D902	D902C
Weight	<ul style="list-style-type: none"> • Vision system with no accessories attached: 380 g (13.4 oz.) • Standard plastic C-Mount cover (COV-7000-CMNT): 35 g (1.23 oz.) • Standard extended plastic C-Mount cover (COV-7000-CMNT-EX): 43 g (1.52 oz.) • Wide plastic C-Mount cover (COV-7000-CMNT-LG): 75.9 g (2.68 oz.) • Wide plastic C-Mount extender (COV-7000-CMNT-LGX): 25.0 g (0.88 oz.) • Autofocus module (ISAF-7000-8mm): 121.5 g (4.29 oz.) • Illumination (ISLM-7000-WHI): 153.5 g (5.41 oz.) 	
Case Temperature ¹	0°C to 65°C (32°F to 149°F)	
Storage Temperature	-20°C to 80°C (-4°F to 176°F)	
Humidity	< 80% non-condensing	
Protection	IP67 with all cables properly attached (or the provided connector plug installed), the IP67-rated cover properly installed, and the Micro SD card cover fastened in place.	
Shock (Shipping and Storage)	IEC 60068-2-27: 18 shocks (3 shocks in each polarity in each (X, Y, Z) axis) 80 Gs (800m/s ² at 11ms, half-sinusoidal) with cables or cable plugs and a 150 gram or lighter lens attached.	
Vibration (Shipping and Storage) ²	IEC 60068-2-6: vibration test in each of the three main axis for 2 hours @ 10 Gs (10 to 500 Hz at 100m/s ² / 15mm) with cables or cable plugs and a 150 gram or lighter lens attached.	
Regulations/Conformity	CE, FCC, KCC, TÜV SÜD NRTL, EU RoHS, China RoHS	

¹ To verify case temperature, use the GetTemperature spreadsheet function, which returns the vision system case temperature in degrees Celsius. For more information, see the *In-Sight® ViDi Help* file. A thermal scanner can also be used to determine the vision system case temperature. Additional cooling measures are required if the case temperature cannot be kept below 65°C. Examples of such measures include: extra heat sinking and/or air movement.

² Before you ship this product or any machinery that contains it, remove lenses that weigh more than 150 grams.

D905 Vision System Specifications

Specifications	D905	D905C
Minimum Firmware Requirement	In-Sight version 2.2.0.	In-Sight version 2.3.0.
Job/Program Memory	16GB non-volatile flash memory; unlimited storage via remote network device.	
Image Processing Memory	3GB SDRAM	
SD Card	1 Micro SD card slot with an 8GB SD card pre-installed for saving job and image files. The vision system supports: <ul style="list-style-type: none"> • SDHC cards with a maximum capacity of 32GB, formatted with a FAT32 file system. • SDXC cards with a maximum capacity of 512GB, formatted with a FAT32 file system. • Speed classes 2, 4, 6 and 10. 	
Sensor Type	2/3-inch CMOS, global shutter	
Sensor Properties	11.1mm diagonal, 3.45 x 3.45µm sq. pixels	
Maximum Image Resolution (pixels)	2448 x 2048	
Electronic Shutter Speed	21µs to 1000ms	
Acquisition	Rapid reset, progressive scan, full-frame integration. High Dynamic Range (HDR+) available.	Rapid reset, progressive scan, full-frame integration.
Bit Depth	256 grey levels (8 bits/pixel)	24-bit color
Frames Per Second (FPS) ¹	26 FPS	16 FPS
Lens Type	C-Mount or S-Mount/M12 <div style="border: 1px solid black; padding: 5px; margin-top: 10px;"> <p>Note: For the In-Sight D905, the S-Mount/M12 lens image circle size is smaller than the vision system's image sensor size, resulting in mechanical vignetting in the image when using any S-Mount/M12 lens. Therefore, S-Mount/M12 lenses are not recommended. For more information, see Mechanical Vignetting on page 81.</p> </div>	
Trigger	1 opto-isolated, acquisition trigger input.	
Discrete Inputs	3 general-purpose inputs when connected to the Breakout cable. ²	
Discrete Outputs	4 high-speed outputs when connected to the Breakout cable. ³	
Status LEDs	SD Card Status, Pass/Fail LED and Indicator Ring, Network LED and Error LED.	

¹ Maximum frames per second are job-dependent, based on the minimum exposure for a full image frame capture using the dedicated acquisition trigger, and assumes there is no user interface connection to the vision system.

² When connected to the Breakout cable, the vision system allows for bi-directional, general-purpose inputs and high-speed outputs for IN 2 / HSOUT 2 and IN 3 / HSOUT 3. These lines are configured as outputs by default.

³ When connected to the Breakout cable, the vision system allows for bi-directional, general-purpose inputs and high-speed outputs for IN 2 / HSOUT 2 and IN 3 / HSOUT 3. These lines are configured as outputs by default.

Specifications	D905	D905C
Internal LED Ring Light	White, Red, Blue or IR LED ring light used with the illumination accessory (ISLM-7000-xxx). <ul style="list-style-type: none"> • White LED color temperature: 4000 K • Red LED wavelength: 617 nm • Blue LED wavelength: 455 nm • IR LED wavelength: 850 nm <p>i Note: For color vision systems, the white LED ring light should be used.</p>	
In-Sight Illumination Accessory (ISLM-7000-xxx)	Cover is compliant with ANSI Z87.1-2003 Drop-Ball Impact Test (no fracture, 25.4mm diameter steel ball, vertical drop from 127cm).	
In-Sight Autofocus Module Accessory (ISAF-7000-8mm)	Number of Focus Cycles: 20,000 <p>i Note: For the In-Sight D905, the S-Mount/M12 lens image circle size is smaller than the vision system's image sensor size, resulting in mechanical vignetting in the image when using any S-Mount/M12 lens. Therefore, S-Mount/M12 lenses are not recommended. For more information, see Mechanical Vignetting on page 81.</p>	
Network Communication	1 Ethernet port, 10/100/1000 BaseT with auto MDIX. IEEE 802.3 TCP/IP Protocol. Supports DHCP, static and link-local IP address configuration.	
Power Consumption	24VDC ±10%, 1.5A maximum. <p>i Note: This product can have repetitive surges with high peak currents. A power source rated for at least 5A continuous current is required to supply these surges and prevent the product from operating unreliably.</p>	
Power Output	24VDC @ 750mA maximum to external light.	
Material	Die-cast and extruded aluminum housing.	
Finish	Painted.	
Mounting	Four M4 threaded mounting holes on front and back of the vision system.	
Dimensions	<ul style="list-style-type: none"> • 53.4mm (2.10in) x 60.5mm (2.38in) x 121.0mm (4.77in). • 99.4mm (3.91in) x 60.5mm (2.38in) x 121.0mm (4.77in) with standard plastic C-Mount cover (COV-7000-CMNT). • 120.4mm (4.74in) x 60.5mm (2.38in) x 121.0mm (4.77in) with standard extended plastic C-Mount cover (COV-7000-CMNT-EX). • 135.7mm (5.34in) x 68.0mm (2.68in) x 121.0mm (4.77in) with wide plastic C-Mount cover (COV-7000-CMNT-LG). • 165.7 (6.52in) x 68.0mm (2.68in) x 121.0mm (4.77in) with wide plastic C-Mount cover (COV-7000-CMNT-LG) and wide plastic C-Mount extender (COV-7000-CMNT-LGX). • 95.1mm (3.74in) x 88.9mm (3.50in) x 121.0mm (4.77in) with Illumination (ISLM-7000-xxx). 	

Specifications	D905	D905C
Weight	<ul style="list-style-type: none"> • Vision system with no accessories attached: 380 g (13.4 oz.) • Standard plastic C-Mount cover (COV-7000-CMNT): 35 g (1.23 oz.) • Standard extended plastic C-Mount cover (COV-7000-CMNT-EX): 43 g (1.52 oz.) • Wide plastic C-Mount cover (COV-7000-CMNT-LG): 75.9 g (2.68 oz.) • Wide plastic C-Mount extender (COV-7000-CMNT-LGX): 25.0 g (0.88 oz.) • Autofocus module (ISAF-7000-8mm): 121.5 g (4.29 oz.) • Illumination (ISLM-7000-WHI): 153.5 g (5.41 oz.) 	
Case Temperature ¹	0°C to 65°C (32°F to 149°F)	
Storage Temperature	-20°C to 80°C (-4°F to 176°F)	
Humidity	< 80% non-condensing	
Protection	IP67 with all cables properly attached (or the provided connector plug installed), the IP67-rated cover properly installed, and the Micro SD card cover fastened in place.	
Shock (Shipping and Storage)	IEC 60068-2-27: 18 shocks (3 shocks in each polarity in each (X, Y, Z) axis) 80 Gs (800m/s ² at 11ms, half-sinusoidal) with cables or cable plugs and a 150 gram or lighter lens attached.	
Vibration (Shipping and Storage) ²	IEC 60068-2-6: vibration test in each of the three main axis for 2 hours @ 10 Gs (10 to 500 Hz at 100m/s ² / 15mm) with cables or cable plugs and a 150 gram or lighter lens attached.	
Regulations/Conformity	CE, FCC, KCC, TÜV SÜD NRTL, EU RoHS, China RoHS	

¹ To verify case temperature, use the GetTemperature spreadsheet function, which returns the vision system case temperature in degrees Celsius. For more information, see the *In-Sight® ViDi Help* file. A thermal scanner can also be used to determine the vision system case temperature. Additional cooling measures are required if the case temperature cannot be kept below 65°C. Examples of such measures include: extra heat sinking and/or air movement.

² Before you ship this product or any machinery that contains it, remove lenses that weigh more than 150 grams.

Acquisition Trigger Input

The vision system features one acquisition trigger input, which is optically isolated. You can configure the acquisition trigger input to trigger from an NPN (current sinking) or PNP (current sourcing) device.

Specification	Description
Voltage	ON: 15 to 28V DC (24VDC nominal) OFF: 0 to 5VDC (11.5VDC nominal threshold)
Current (Typical)	ON: 2.6mA to 4.9mA from 15 to 28V input OFF: < 830µA for < 5VDC input Resistance: ~6 kOhms
Delay (Typical)	13µs

- To trigger from an NPN type photoelectric sensor or PLC output, connect COMMON IN to +24VDC and connect TRIGGER to the output of the photoelectric sensor. When the output turns ON, it pulls TRIGGER down to 0VDC, turning the opto-coupler ON. For more information, refer to [Breakout Cable on page 70](#).
- To trigger from a PNP photoelectric sensor or PLC output, connect TRIGGER to the output of the photoelectric sensor and connect COMMON IN to 0VDC. When the output turns ON, it pulls TRIGGER up to +24VDC, turning the opto-coupler ON. For more information, refer to [Breakout Cable on page 70](#).

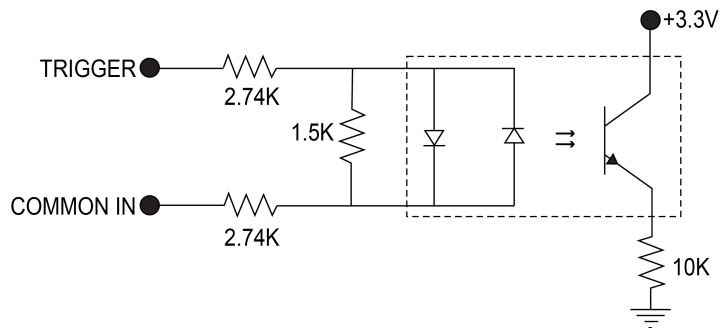

26.4V Max. across input pins - Transition approximately 12V (Min.)

General-Purpose Inputs

The vision system features three built-in general-purpose inputs, which are optically isolated. The inputs can be configured as either NPN (current sinking) or PNP (current sourcing) lines.

Specification	Description
Voltage	ON: 15 to 28V DC (24DC nominal) OFF: 0 to 5VDC (11.5VDC nominal threshold)
Current (Typical)	ON: 2.6mA to 4.9mA from 15 to 28V input OFF: < 830 μ A for < 5VDC input Resistance: ~6 kOhms
Delay (Electrical)	100ns (maximum)

- For NPN lines, connect COMMON IN to +24VDC and connect IN 1 to the output of the photoelectric sensor or PLC. When the output turns ON, it pulls IN 1 down to 0VDC, turning the opto-coupler ON.
- For PNP lines, connect IN 1 to the output of the detector and connect COMMON IN to 0VDC. When the output turns ON, it pulls IN 1 up to +24VDC, turning the opto-coupler ON.

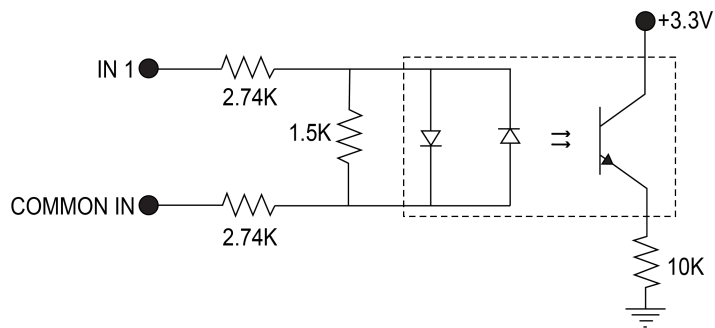

26.4V Max. across input pins - Transition approximately 12V (Min.)

High-Speed Outputs

The vision system features four¹ built-in, high-speed outputs, which are optically isolated. The high-speed outputs can be used as either NPN (current sinking) or PNP (current sourcing) lines.

Specification	Description
Voltage	26.4VDC maximum through external load
Current	50mA maximum sink or source current
	OFF state leakage current 100µA
	External load resistance 470 Ohms to 10K Ohms
	Each line rated at a maximum 50mA, protected against over-current, short circuits and transients from switching inductive loads. High current inductive loads require an external protection diode.
Delay (Electrical)	15ms ON time (maximum) and 40ms OFF time (maximum)

For NPN lines, the external load should be connected between the output and the positive supply voltage (<26.4VDC). The output pulls down to less than 3VDC when ON, which causes current to flow through the load. When the output is OFF, no current flows through the load.

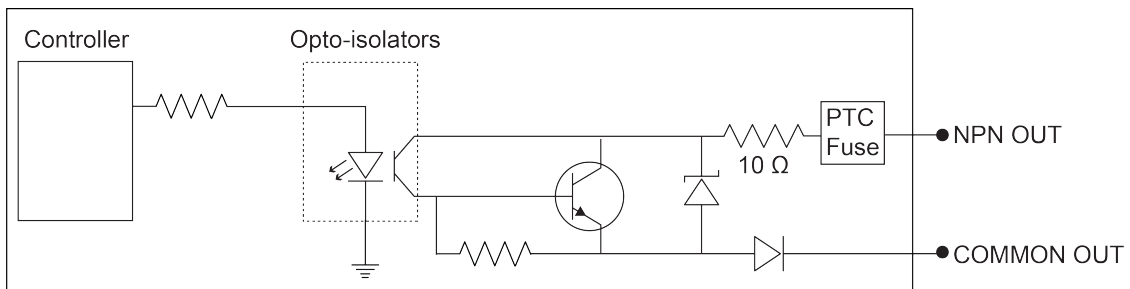

For PNP lines, the external load should be connected between the output and the negative supply voltage (0VDC). When connected to a 24VDC power supply, the output pulls up greater than 21VDC when ON, and current flows through the load. When the output is OFF, no current flows through the load.

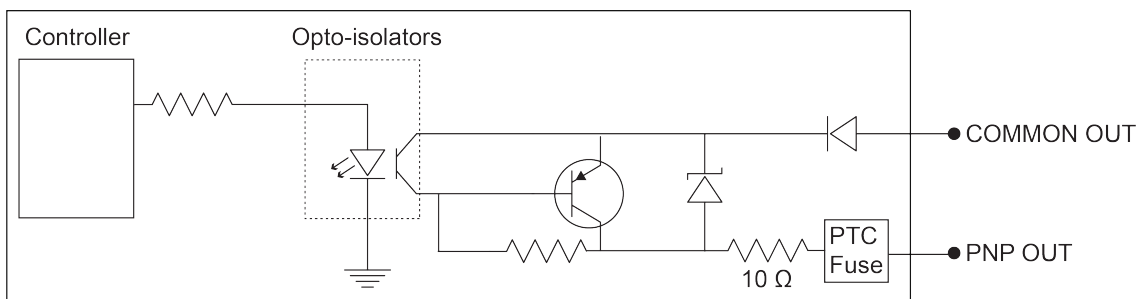

¹ When connected to the Breakout cable, the vision system allows for bi-directional, general-purpose inputs and high-speed outputs for IN 2 / HSOUT 2 and IN 3 / HSOUT 3. These lines are configured as outputs by default.

High-Speed Output Wiring

To connect to an NPN-compatible PLC input, connect one of the vision system's high-speed outputs directly to the PLC input. When enabled, the output pulls the PLC input down to less than 3VDC.

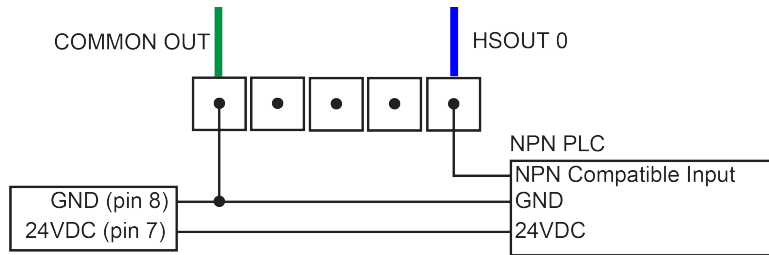

To connect to a PNP-compatible PLC input, connect one of the vision system's high-speed outputs directly to the PLC input. When enabled, the output pulls the PLC input up to greater than 21VDC.

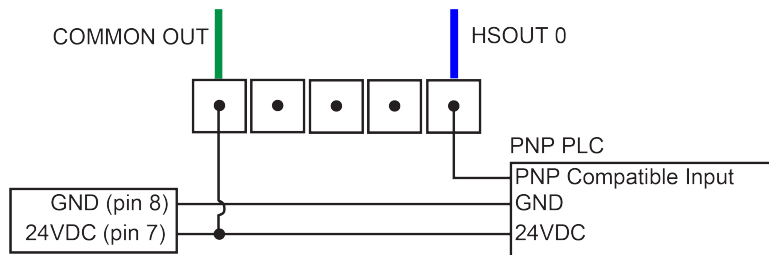

To connect the high-speed outputs to a relay, LED or similar load, connect the negative side of the load to the output and the positive side to +24VDC. When the output switches on, the negative side of the load is pulled down to less than 3VDC, and 24VDC appears across the load. Use a protection diode for a large inductive load, with the anode connected to the output and the cathode connected to +24VDC.

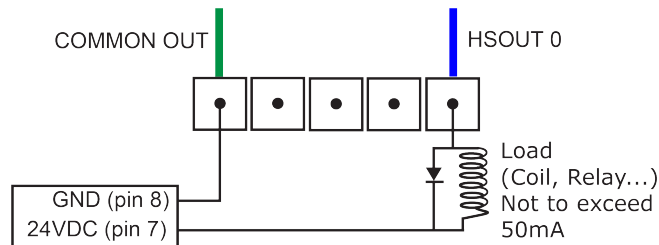

External Light Connector

The vision system's LIGHT connector is used to connect the External Light cable to an external lighting device, providing power and strobe control. The External Light cable can be connected to either a continuous or strobed lighting device. Before using an external lighting device, you must configure the light settings within the In-Sight Vision Suite software.

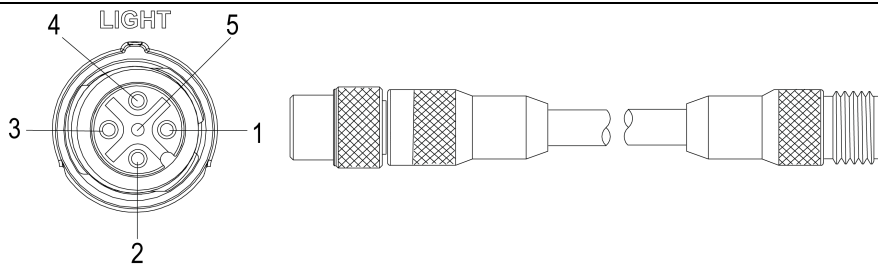

Pin#	Signal Name	Wire Color
1	+24VDC	Brown
2	Intensity Control	White
3	GND	Blue
4	Strobe	Black
5	Chassis	Not Connected

Note:

- Cables are sold separately.
- Current load: 750 mA maximum. Only the +24VDC pin is capable of sourcing 750mA.
- Intensity Control is an analog signal that ranges from 0 to +10VDC, and is configurable within the In-Sight Vision Suite software. It is a control signal only, and must not be used to power an external device. Power should be sourced from +24VDC and GND. Verify the External Light cable and light support intensity control.
- The Strobe output is active low 0VDC and active high +12VDC, with the Polarity configurable within the In-Sight Vision Suite software. It is a control signal only and may not be used for power. Power should be sourced from +24VDC and GND.



Ethernet Cable

The Ethernet cable provides Ethernet connectivity to the vision system.

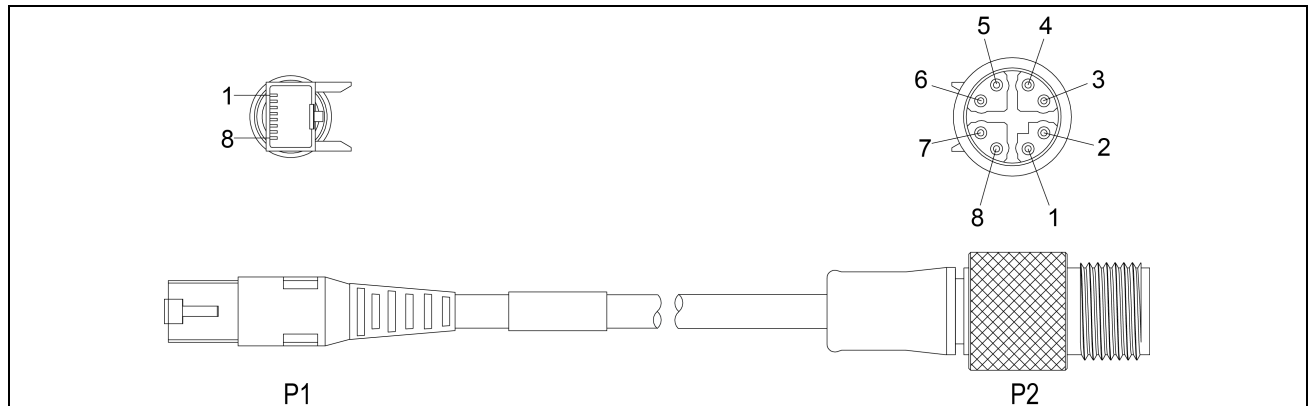

P1 Pin Number	Wire Color	Signal Name	P2 Pin Number
1	White/Orange	TxRx A +	1
2	Orange	TxRx A -	2
3	White/Green	TxRx B +	3
4	Blue	TxRx C +	8
5	White/Blue	TxRx C -	7
6	Green	TxRx B -	4
7	White/Brown	TxRx D +	5
8	Brown	TxRx D -	6

CAUTION: The Ethernet cable shield must be grounded at the far end. Whatever this cable is plugged into (typically a switch or router) should have a grounded Ethernet connector. A digital voltmeter should be used to validate the grounding. If the far end device is not grounded, a ground wire should be added in compliance with local electrical codes.

Note:



- Cables are sold separately.
- The wiring for this cable follows standard industrial Ethernet M12 specifications. It differs from the 568B standard.

Breakout Cable

The Breakout cable provides connections to an external power supply, the acquisition trigger input, general-purpose inputs and high-speed outputs. The Breakout cable is not terminated.

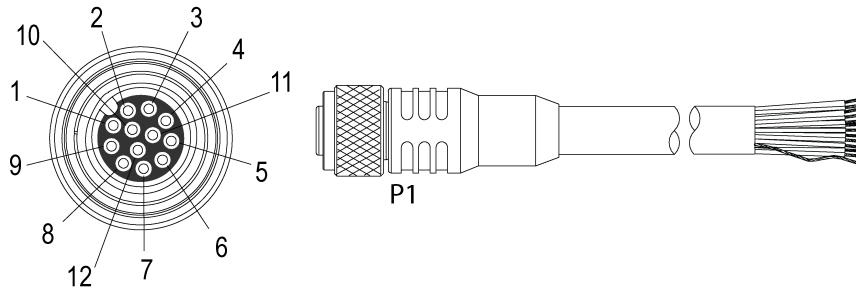

Pin#	Signal Names	Wire Color
1	IN 2 / HSOUT 2	Yellow
2	UNUSED	White/Yellow
3	UNUSED	Brown
4	IN 3 / HSOUT 3	White/Brown
5	IN 1	Violet
6	COMMON IN	White/Violet
7	+24VDC	Red
8	GND	Black
9	COMMON OUT	Green
10	TRIGGER	Orange
11	HSOUT 0	Blue
12	HSOUT 1	Grey

Note:

- Cables are sold separately.
- Perform wiring or adjustments to I/O devices when the vision system is not receiving power.
- You can cut exposed wires short or trim wire ends. You also can tie the wires back if you use a tie made of non-conductive material. Keep bare wires separated from the +24VDC wire.
- If using an integrated or external illumination accessory, the 10 meter and 15 meter Breakout cables are not supported.
- When using the 15 meter Breakout cable, full 24VDC voltage must be maintained at the input leads of the Breakout cable when the vision system is operating.



Dimensions

The following sections list dimensions of the vision system and optional accessories.

D902 Vision System

Note:



- Dimensions are in millimeters [inches] and are for reference purposes only.
- All specifications are for reference purposes only and can change without notice.

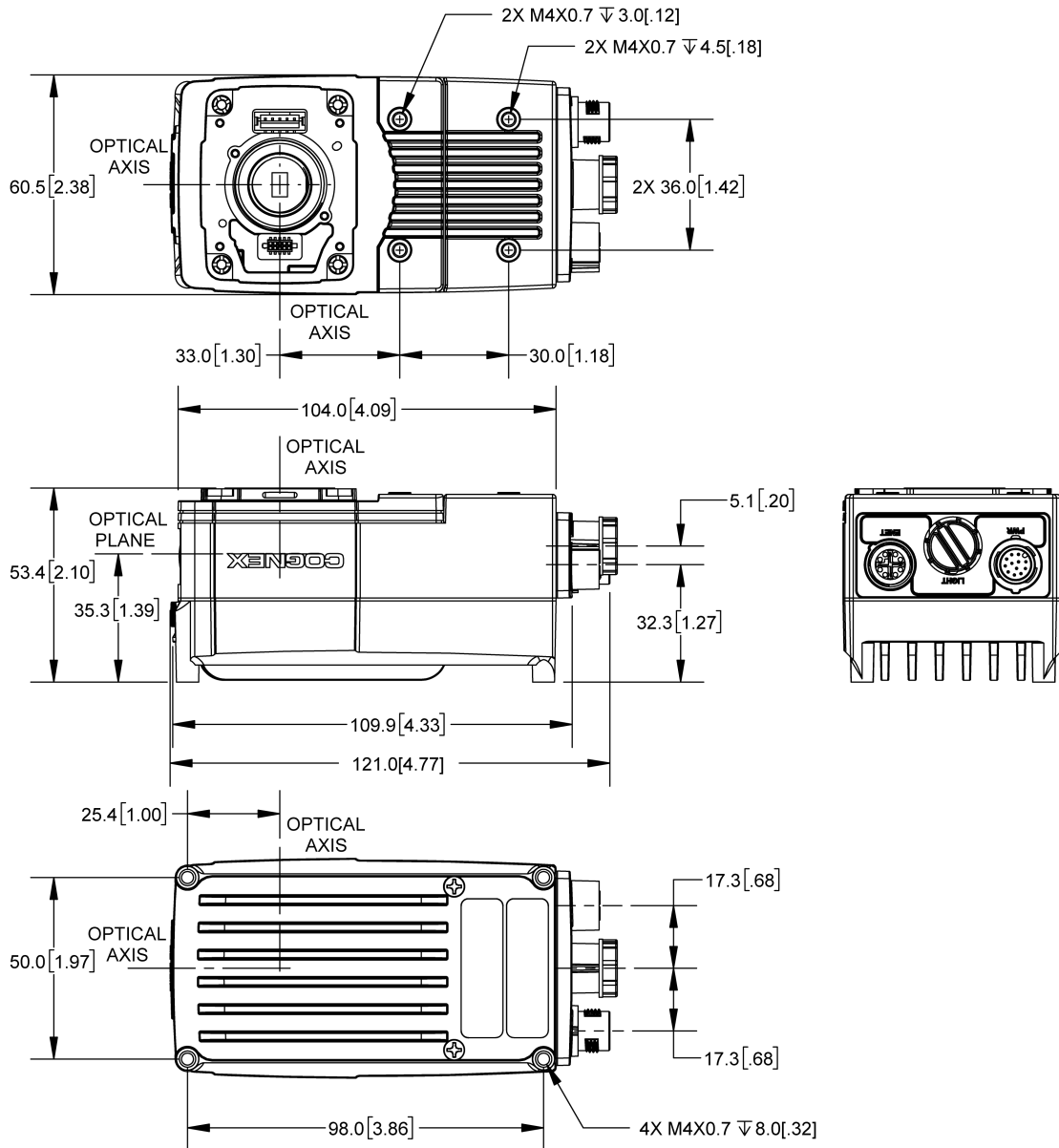

D905 Vision System

Note:



- Dimensions are in millimeters [inches] and are for reference purposes only.
- All specifications are for reference purposes only and can change without notice.

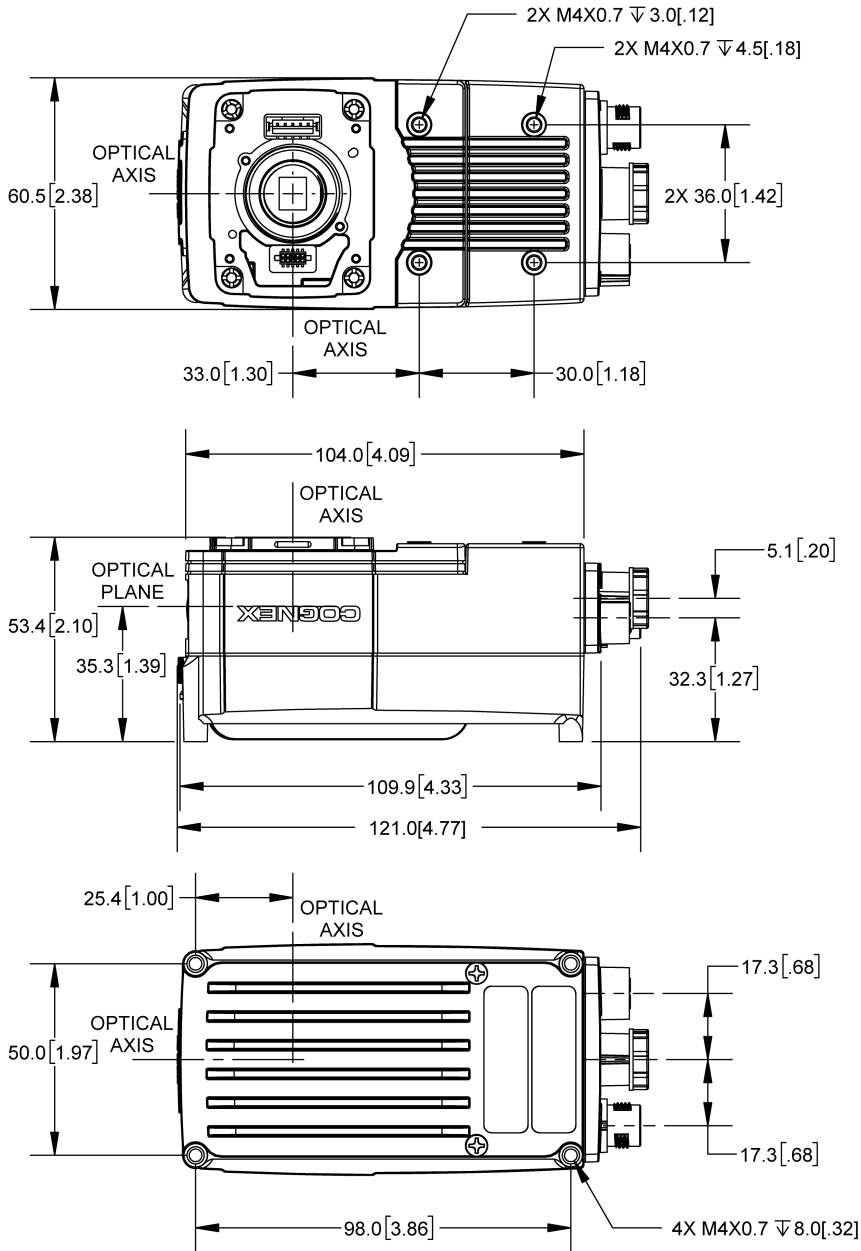

D900 Series Vision System with Cover (COV-7000-CMNT)

Note:



- Dimensions are in millimeters [inches] and are for reference purposes only.
- All specifications are for reference purposes only and can change without notice.

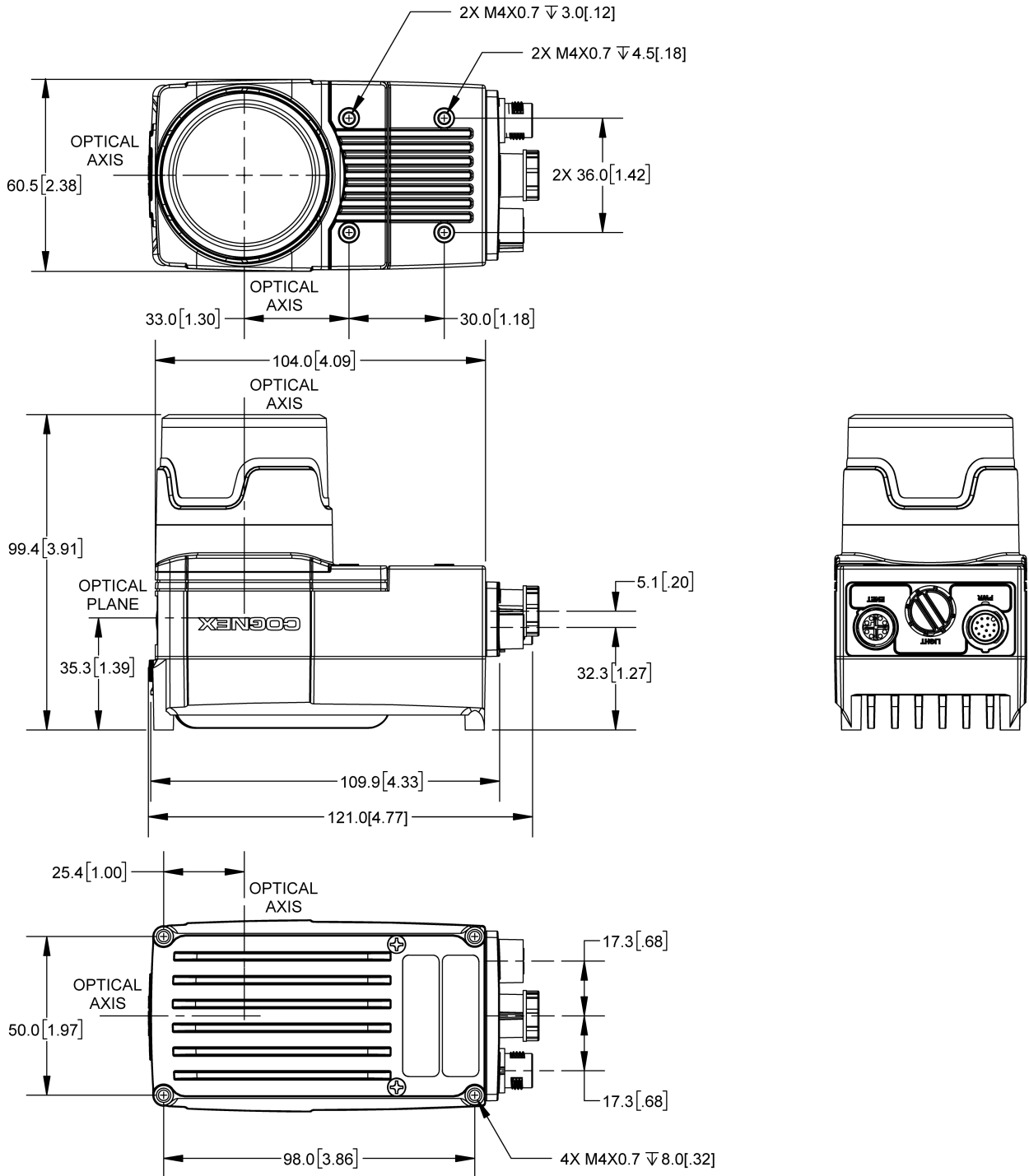

D900 Series Vision System with Cover (COV-7000-CMNT-EX)

Note:



- Dimensions are in millimeters [inches] and are for reference purposes only.
- All specifications are for reference purposes only and can change without notice.

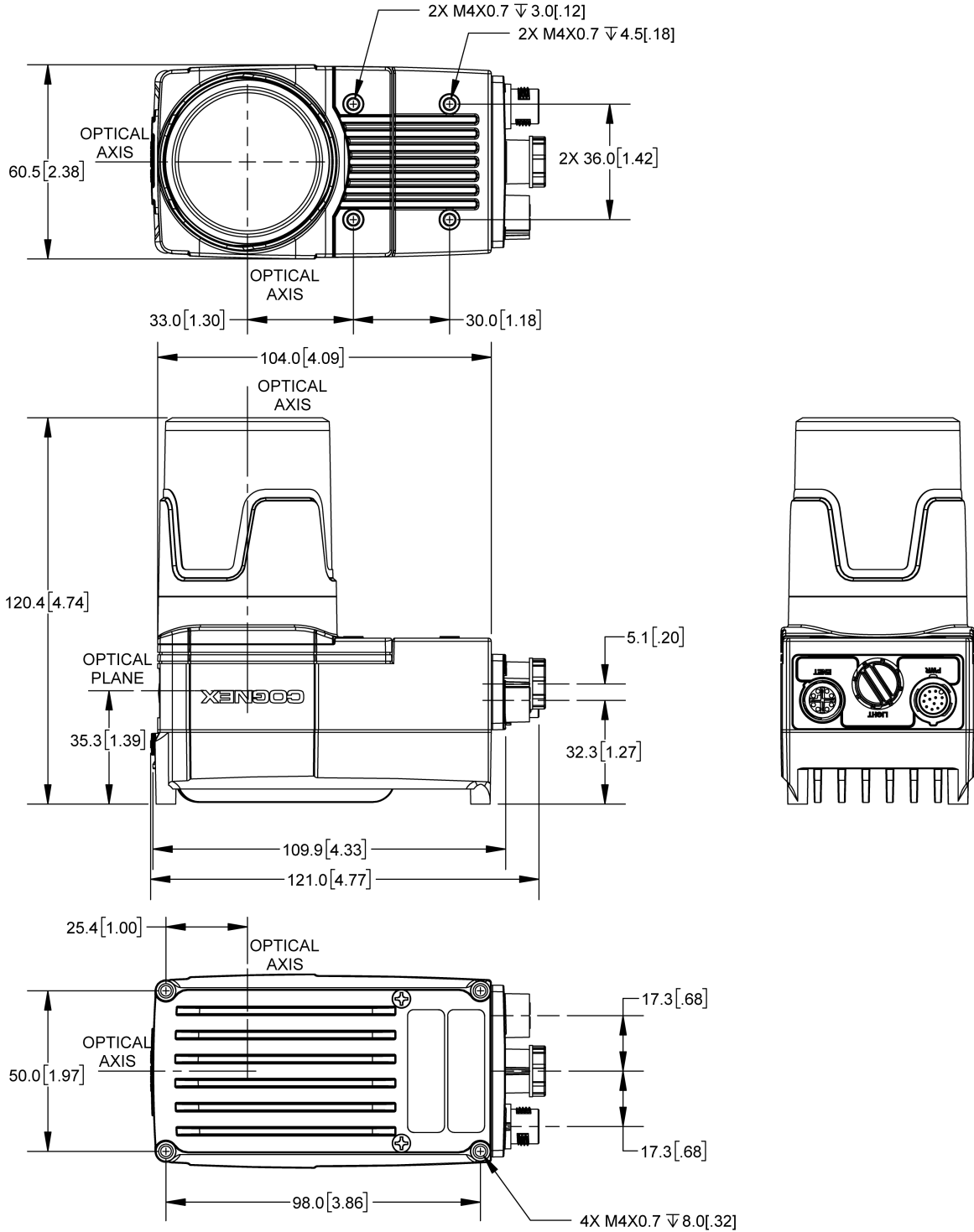

D900 Series Vision System with Cover (COV-7000-CMNT-LG)

Note:



- Dimensions are in millimeters [inches] and are for reference purposes only.
- All specifications are for reference purposes only and can change without notice.

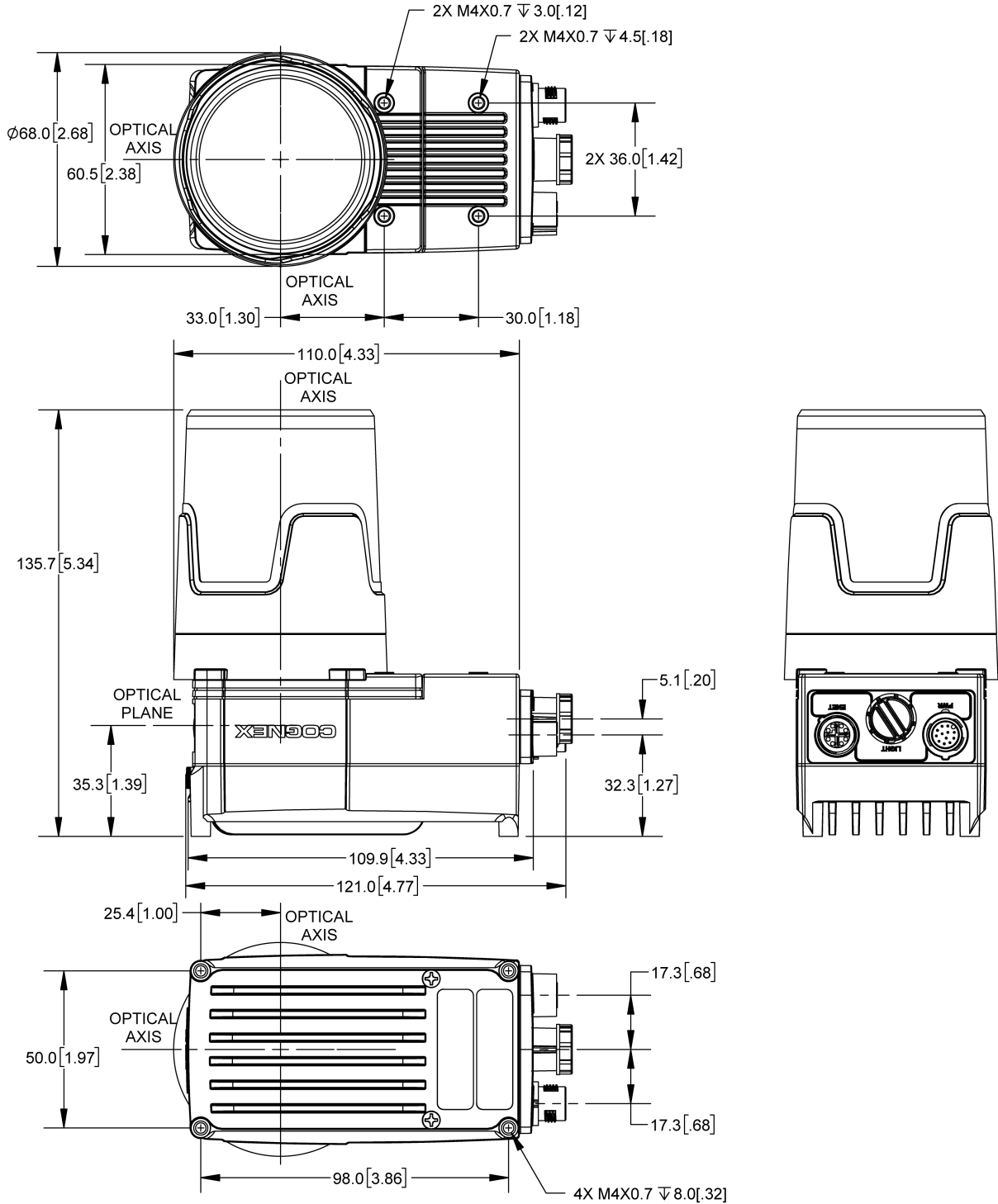

D900 Series Vision System with Cover (COV-7000-CMNT-LG) and Extender (COV-7000-CMNT-LGX)

Note:



- Dimensions are in millimeters [inches] and are for reference purposes only.
- All specifications are for reference purposes only and can change without notice.

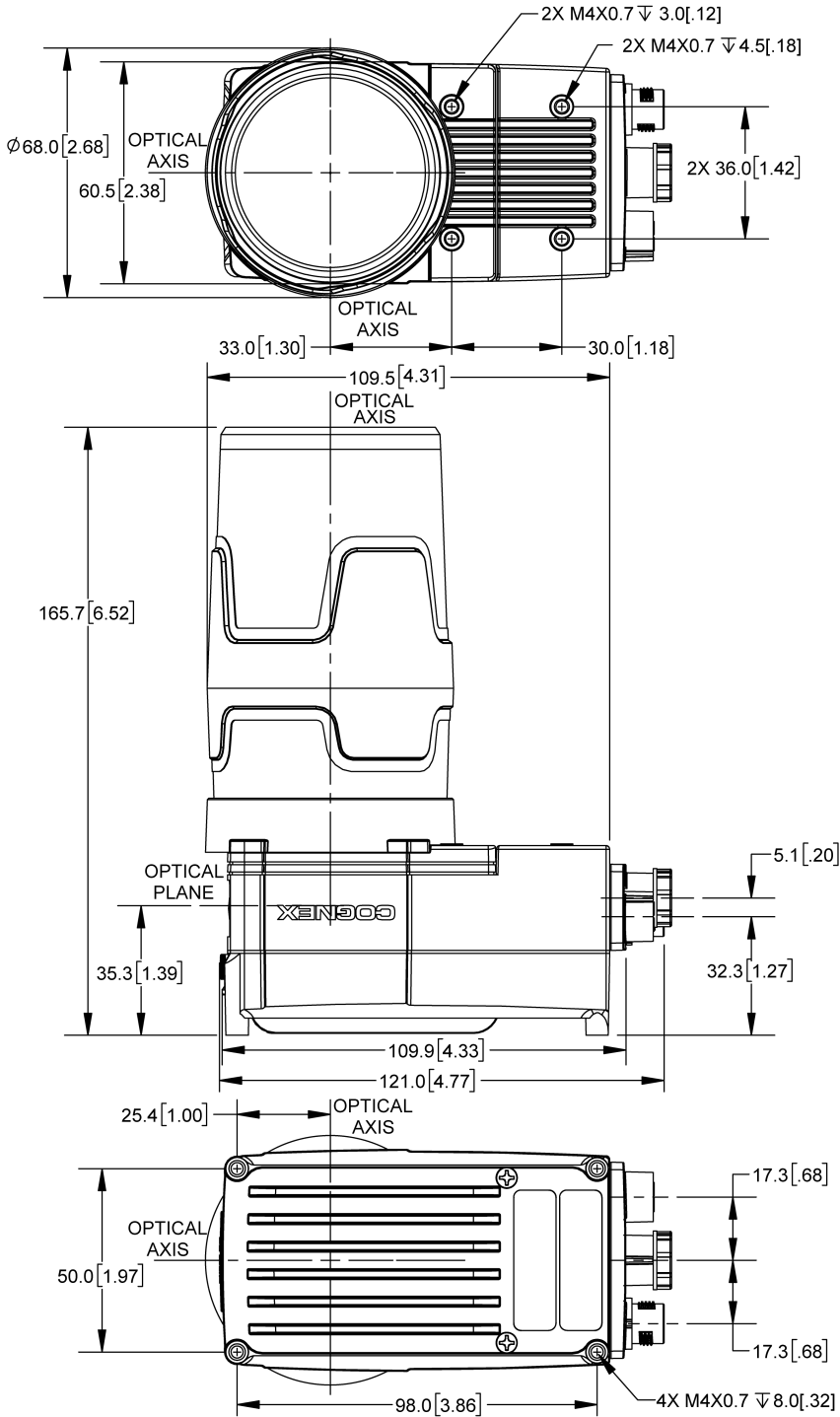

D900 Series Vision System with Illumination (ISLM-7000-xxx)

Note:



- Dimensions are in millimeters [inches] and are for reference purposes only.
- All specifications are for reference purposes only and can change without notice.

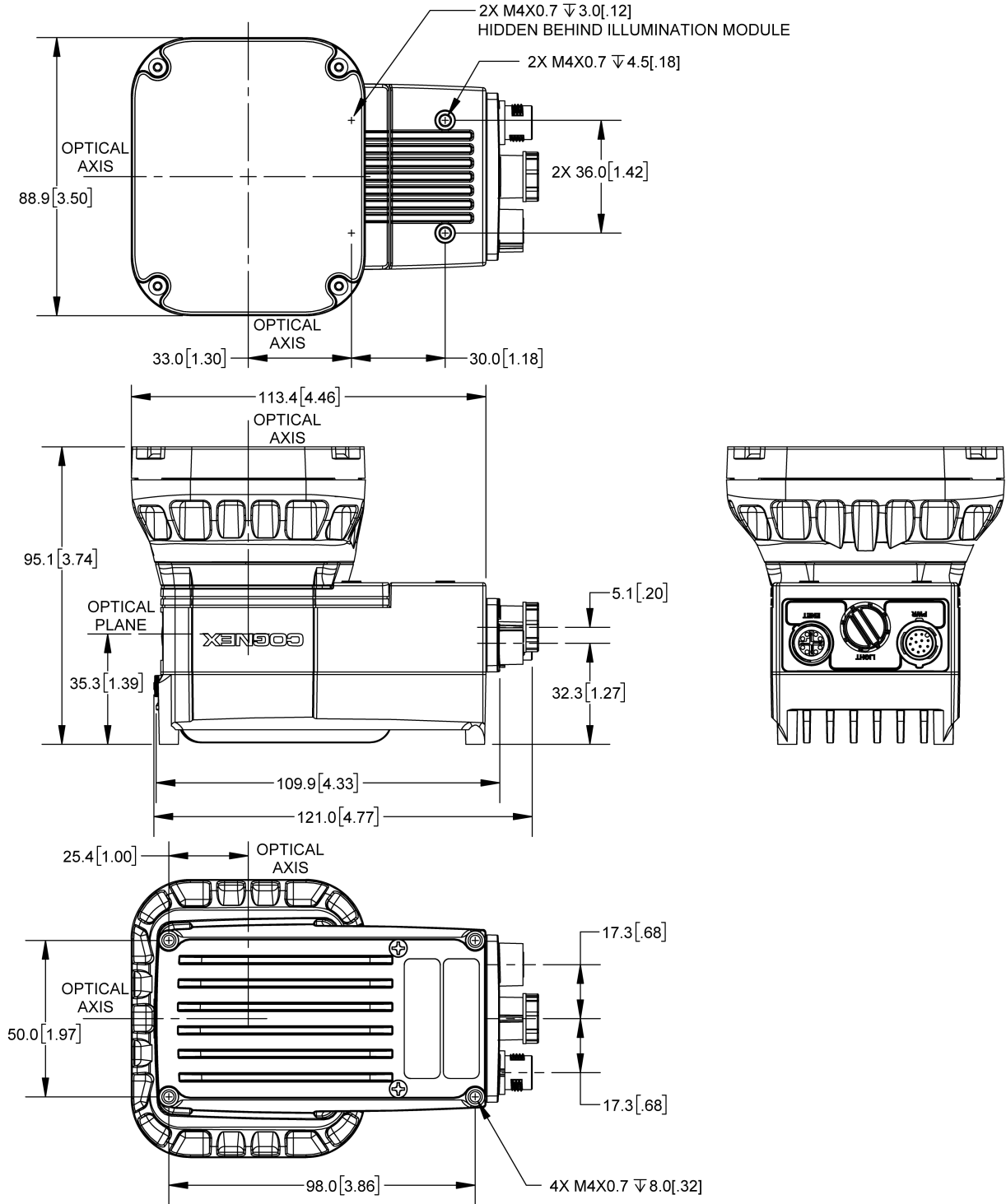

Mounting Bracket (BKT-INS-01)

Note:



- Dimensions are in millimeters [inches] and are for reference purposes only.
- All specifications are for reference purposes only and can change without notice.

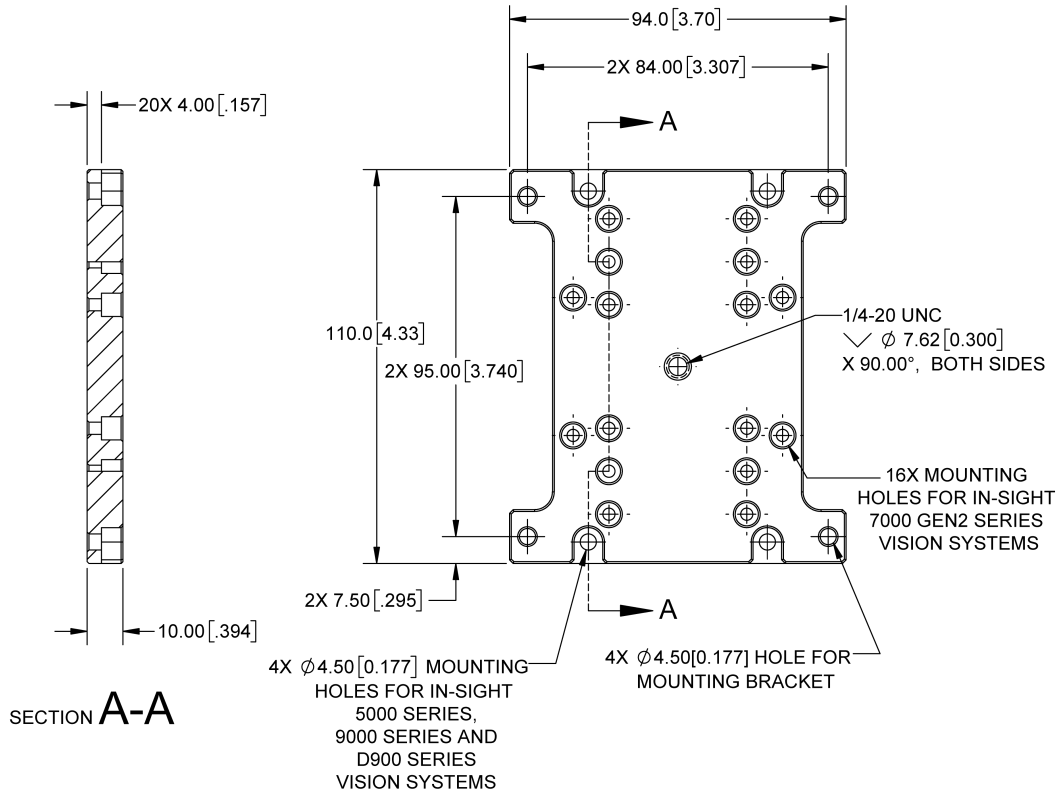

C-Mount Lens Clearance Dimensions

Note:

- When using a C-Mount lens, the following restrictions apply:
 - Maximum thread length is 5.25mm.
 - The C-Mount lens threads and body cannot protrude more than 6.5mm in length into the vision system when screwed in unless the diameter of the back lens is smaller than 14.75mm. If the C-Mount lens threads and body protrude more than 6.5mm, you can add a spacer between the lens and vision system. However, the spacer decreases the working distance.
- Dimensions are in millimeters [inches] and are for reference purposes only.
- All specifications are for reference purposes only and can change without notice.

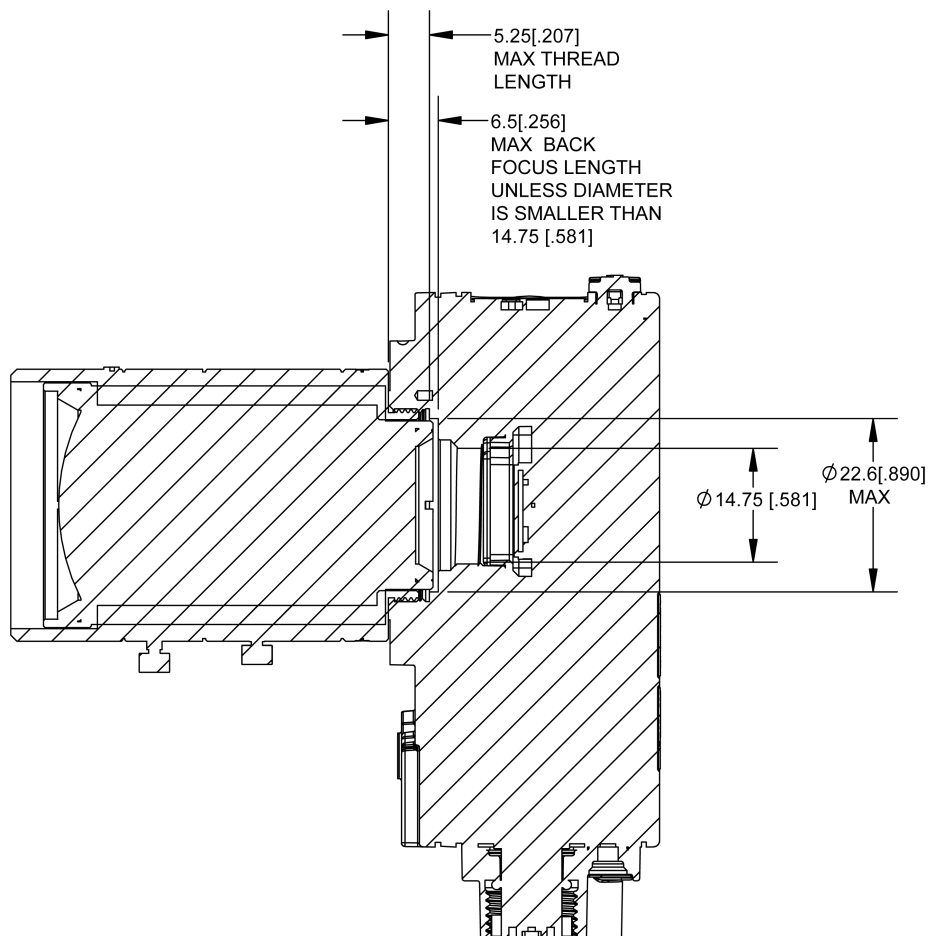

Cleaning/Maintenance

Clean the Housing

To clean the outside of the vision system housing, use a small amount of mild detergent cleaner or isopropyl alcohol on a cleaning cloth. Do not pour the cleaner on the vision system housing.

 **CAUTION:** Do not attempt to clean any DataMan product with harsh or corrosive solvents, including lye, methyl ethyl ketone (MEK) or gasoline.

Clean the Image Sensor Window

To remove dust from the outside of the image sensor window, use a pressurized air duster. The air must be free of oil, moisture or other contaminants that could remain on the glass and possibly degrade the image. Do not touch the glass window. If oil or smudges remain, use a cotton bud and alcohol (ethyl, methyl, or isopropyl) to clean the window. Do not pour the alcohol on the window.

Clean the Cover

To remove dust from the lens cover, use a pressurized air duster. The air must be free of oil, moisture or other contaminants that could remain on the lens cover. To clean the plastic window of the lens cover, use a small amount of isopropyl alcohol on a cleaning cloth. Do not scratch the plastic window. Do not pour the alcohol on the plastic window.

Appendix

Mechanical Vignetting

All lenses are designed to cover a certain “image circle” size, which can be found in the lens manufacturer’s specification. The image circle size is the diameter of the optical image the lens can produce. If a vision system has 2/3” image sensor, you must use a lens that produces at least a 2/3” image circle.

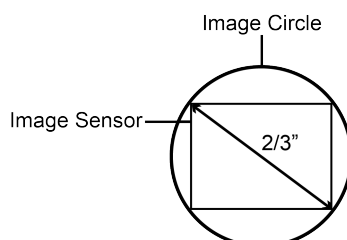

Otherwise, the lens optics will not cover the image sensor, resulting in dark corners. The mismatch of image circle to image sensor size is one cause of mechanical vignetting.

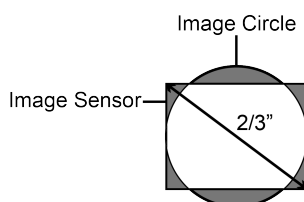

The In-Sight D905 vision system has a 2/3” image sensor. The S-Mount/M12 lenses used in the autofocus module (ISAF-7000-8mm) and the S-Mount/M12 adapter kit (ISLN-7000-SMNT) have a smaller image circle. Therefore, these S-Mount lenses will cause mechanical vignetting when used with the In-Sight D905 vision system, and the corners of the image will be cropped to the size of the lens.

Here is an example of mechanical vignetting when using the In-Sight D905 vision system with an 8mm S-Mount/M12 lens at a 100mm working distance:

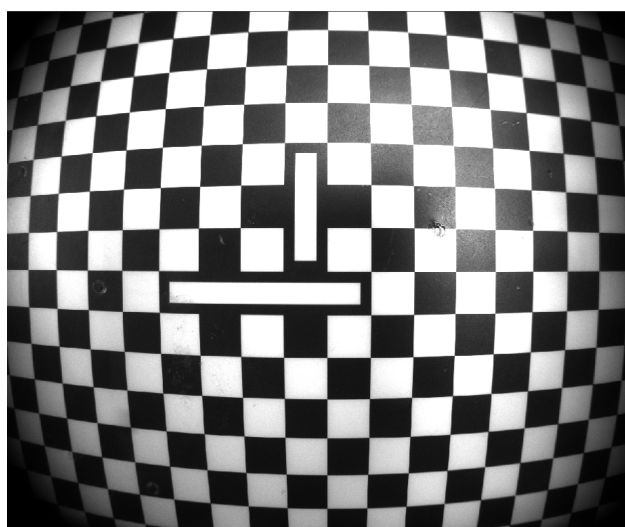

Remove the Illumination Accessory PCB

If the illumination accessory (ISLM-7000-WHI) must be uninstalled from the vision system, complete the following steps to safely remove the PCB and avoid damage to the vision system.

CAUTION: Do not hot-plug the illumination accessory. Verify the vision system is not receiving power when connecting or disconnecting the illumination accessory. Failure to remove power during this procedure may result in damage to the vision system and/or the illumination accessory.

1. Remove power from the vision system.
2. Use a 2mm hex wrench to remove the four spacer screws. Remove the spacer.

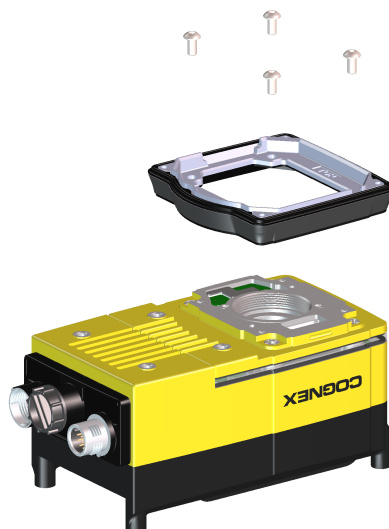

3. The vision system faceplate includes two lift points on either side of the PCB. Position an insulated extractor tool (for example, Jonard Tools S-340 DIP/IC Extractor) under the edges of the PCB.

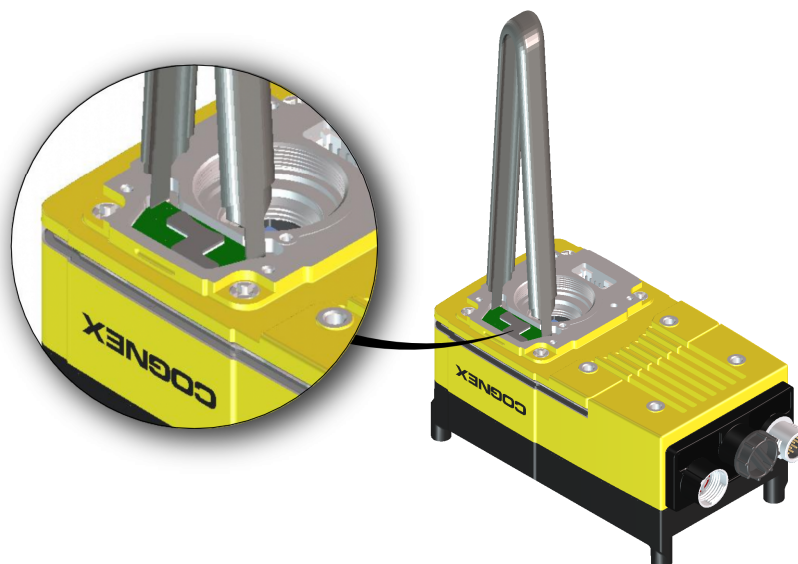

- Once the extractor is engaged under the edges of the PCB, gently pull upward to disengage the PCB from the internal connector and remove the PCB.

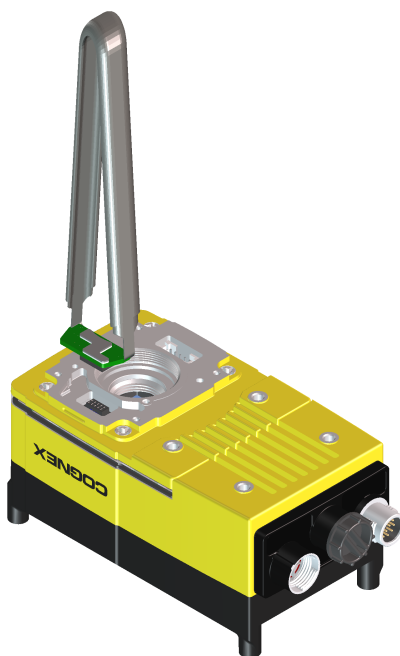

- Verify the removal process did not damage mating components.

