

# COGNEX

## In-Sight<sup>®</sup> 3D-A1000 Series Vision System Manual



2024 January 15  
Revision: 24.1.0.1

# Regulations and Conformity



**Note:** For the most current CE declaration and regulatory conformity information, see the Cognex support site: [cognex.com/support](http://cognex.com/support).

Safety and Regulatory	
Manufacturer	Cognex Corporation One Vision Drive Natick, MA 01760 USA
	In-Sight 3D-A1000 Series: Regulatory Model R00093 This is a class A product. In a domestic environment this product may cause radio interference in which case the user may be required to take immediate measures. This equipment complies with the essential requirements of the EU Directive 2014/30/EU. Declarations are available from your local representative.
EU RoHS	Compliant to the most recent applicable directive.
FCC	FCC Part 15, Class A This equipment has been tested and found to comply with the limits for a Class A digital device, pursuant to part 15 of the FCC Rules. These limits are designed to provide reasonable protection against harmful interference when the equipment is operated in a commercial environment. This equipment generates, uses, and can radiate radio frequency energy and, if not installed and used in accordance with the instruction manual, may cause harmful interference to radio communications. Operation of this equipment in a residential area is likely to cause harmful interference in which case the user will be required to correct the interference at his own expense.
Laser Safety Certification	IEC 60825-1 US FDA CDRH Filing
Korea 	In-Sight 3D-A1000: Regulatory Model R00093: R-R-CGX-R00093 This device is certified for office use only and if used at home, there can be frequency interference problems.

<b>Safety and Regulatory</b>	
NRTL	TÜV SÜD SCC/NRTL OSHA Scheme for UL/CAN 61010-1.
CB	TÜV SÜD, IEC/EN 61010-1. CB report available upon request.

# China RoHS



	Hazardous Substances 有害物质					
Part Name 部件名称	Lead (Pb) 铅	Mercury (Hg) 汞	Cadmium (Cd) 镉	Hexavalent Chromium (Cr (VI)) 六价铬	Polybrominated biphenyls (PBB) 多溴联苯	Polybrominated diphenyl ethers (PBDE) 多溴二苯醚
Regulatory Model R00093	X	O	O	O	O	O
<p>This table is prepared in accordance with the provisions of SJ/T 11364. 这个标签是根据SJ/T 11364的规定准备的。</p> <p>O: Indicates that said hazardous substance contained in all of the homogeneous materials for this part is below the limit requirement of GB / T26572 - 2011. 表示本部件所有均质材料中含有的有害物质低于GB / T26572 - 2011的限量要求。</p> <p>X: Indicates that said hazardous substance contained in at least one of the homogeneous materials used for this part is above the limit requirement of GB / T26572 - 2011. 表示用于本部件的至少一种均质材料中所含的有害物质超过GB / T26572 - 2011的限制要求。</p>						

## For European Community Users

Cognex complies with Directive 2012/19/EU OF THE EUROPEAN PARLIAMENT AND OF THE COUNCIL of 4 July 2012 on waste electrical and electronic equipment (WEEE).

This product has required the extraction and use of natural resources for its production. It may contain hazardous substances that could impact health and the environment, if not properly disposed.

In order to avoid the dissemination of those substances in our environment and to diminish the pressure on the natural resources, we encourage you to use the appropriate take-back systems for product disposal. Those systems will reuse or recycle most of the materials of the product you are disposing in a sound way.



The crossed out wheeled bin symbol informs you that the product should not be disposed of along with municipal waste and invites you to use the appropriate separate take-back systems for product disposal.

If you need more information on the collection, reuse, and recycling systems, please contact your local or regional waste administration.

You may also contact your supplier for more information on the environmental performance of this product.

# Laser Information

**i** **Note:** The information in this section applies to 3D-A1000 systems of type 821-10158-001.

**⚠** **WARNING:** Laser Radiation, Avoid Direct Eye Exposure. Class 1 Laser Product. Failure to follow these instructions may cause serious injury.

Cognex Corporation places the following label on the head of every vision system:

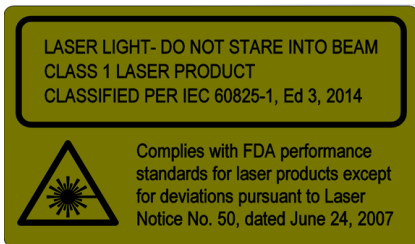

Compliance with FDA performance standards for laser products except for deviations pursuant to Laser notice No.50, dated June 24, 2007. This device has been tested in accordance with IEC 60825-1 Edition 3, and has been certified to be under the limits of a Class I Laser product.

**⚠** **CAUTION:** Use of controls or adjustments or performance of procedures other than those specified herein may result in hazardous radiation exposure.

# Laser Information

**i** **Note:** The information in this section applies to 3D-A1000 systems of type 821-10158-002.

LASER RADIATION - DO NOT STARE INTO  
BEAM. CLASS 1 LASER PRODUCT  
CLASSIFIED PER IEC 60825-1:2014

Laser Characteristic	Value
Maximum output power	2 W
Pulse duration	10 $\mu$ s to 10 ms
Emitted wavelength	850 nm
Classification	Classified per IEC60825-1:2014

# Precautions

To reduce the risk of injury or equipment damage, observe the following precautions when you install the Cognex product:

- The vision system requires a UL or NRTL listed power supply with a 24VDC output that meets the rating requirements below. Any other voltage creates a risk of fire or shock and can damage the components. Applicable national and local wiring standards and rules must be followed.
- The power supply must be capable of supplying a current of 3A MAX with 1A RMS.
- Turn off the 24VDC power supply before connecting or disconnecting the power cable.
- Route cables and wires away from high-current wiring or high-voltage power sources to reduce the risk of damage or malfunction from the following causes: over-voltage, line noise, electrostatic discharge (ESD), power surges, or other irregularities in the power supply.
- Do not install Cognex products where they are exposed to environmental hazards such as excessive heat, dust, moisture, humidity, impact, vibration, corrosive substances, flammable substances, or static electricity.
- Changes or modifications not expressly approved by the party responsible for regulatory compliance could void the user's authority to operate the equipment.
- Include service loops with cable connections.
- Ensure that the cable bend radius begins at least six inches from the connector. Cable shielding can be degraded or cables can be damaged or wear out faster if a service loop or bend radius is tighter than 10X the cable diameter.

- This device should be used in accordance with the instructions in this manual.
- All specifications are for reference purposes only and can change without notice.

# In-Sight 3D-A1000 Series Vision System

1



## Legend

1 = 3D-A1000

2 = Ethernet Cable

3 = Breakout Cable

3



2

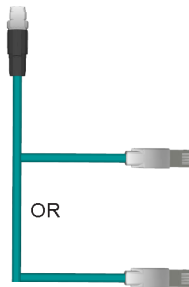

- INPUT 2 (Yellow)
- NC (White/Yellow)
- NC (Brown)
- INPUT 3 (White/Brown)
- INPUT 1 (Violet)
- COMMON IN (White/Violet)
- +24VDC (Red)
- GND (Black)
- COMMON OUT (Green)
- TRIGGER (Orange)
- OUT 0 (Blue)
- OUT 1 (Grey)

# Installation

For a list of options and accessories, contact your Cognex sales representative.

For more information on the software used for configuring the 3D vision system and the vision application, refer to the *In-Sight 3D User Guide* installed with the In-Sight VC Explorer software.

---

 **Note:** Cables are sold separately.

---

 **CAUTION:** All cable connectors are keyed to fit the connectors on the vision system. Do not force the connections or damage may occur.

---

IR Projector

2D Camera

IR Camera



Front View



Side View

Top View (not to scale)

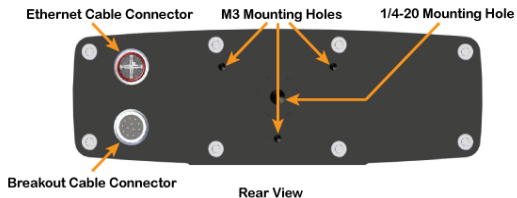

Rear View

## Install the Mounting Bracket

The 3D-A1000 supports various mounting brackets. Contact your sales representative or Cognex Support to select the one best suited to your operational environment.

When mounting the vision system to the mounting bracket, use the M3 screws supplied with the mounting kit.

Allowing the mounting screws to bottom in the mounting hole can damage the vision system.



**CAUTION:** The vision system case should be grounded, either by mounting the vision system to a fixture that is electrically grounded or by attaching a wire from the vision system chassis to frame ground or Earth ground. If a ground wire is used, attach the ground wire to one of the four mounting points on the back plate of the vision system.

---

1. Align the mounting bracket with the mounting holes on the vision system.
2. Insert the M3 screws into the mounting holes and tighten using a 2.5mm hex wrench; the maximum torque is 0.90 Nm (8 in-lb).

## Connect the Ethernet Cable

---



**CAUTION:** The Ethernet cable shield must be grounded at the far end. The device this cable is plugged into (typically a switch or router) should have a grounded Ethernet connector. A digital voltmeter should be used to validate the grounding. If the far end device is not grounded, a ground wire should be added in compliance with local electrical codes.

---

1. Connect the M12 connector of the Ethernet cable to the vision system's ENET connector.
2. Connect the RJ-45 connector of the Ethernet cable to a switch/router or PC, as applicable.

## Connect the Breakout Cable

---



**CAUTION:** To reduce emissions, connect the far end of the breakout cable shield to frame ground.

---



**WARNING:** Wires 2 (White/Yellow) and 3(Brown) are NC and must never be connected to anything.

---

I/O wiring or adjustments to I/O devices should be performed when the vision system is not receiving power. You can cut exposed wires short or trim wire ends. You also can tie the wires back if you use a tie made of non-conductive material. Keep bare wires separated from the +24VDC wire.

1. Verify that the 24VDC power supply is unplugged and not receiving power.
  2. Optionally, connect the I/O wires to an appropriate device.
  3. Attach the +24VDC (Red) wires and digital GND (Black) wires of the Breakout cable to the corresponding terminals on the power supply.
- 



**CAUTION:** Never connect voltages other than 24VDC. Always observe the polarity shown.

---

4. Connect the M12 connector of the Breakout cable to the PWR connector of the vision system.
- 



**WARNING:** Keep bare wires separated from each other and from the 24V power wires.

---

## Install a Hardware Trigger, Encoder or Strobe

The 3D-A1000 supports single-channel encoders with a frequency of 1 kHz. For encoders, use the following leads from the Breakout cable:

- INPUT 1 (Violet)
- COMMON IN (White/Violet)

**i Note:** 3D-A1000 supports encoders only on INPUT 1.

Use the following leads for an external hardware trigger:

- TRIGGER (Orange)
- Common In (White/Violet)

See the topic *Acquisition Trigger Input* on page 17 for details on the trigger line.

Use OUT 0 for general output or strobe.

- OUT 0 (Blue)
- Common out (Green)

**i Note:** 3D-A1000 supports strobes only on OUT 0.

## Acquisition Trigger Input

The 3D-A1000 features one acquisition trigger input, which is optically isolated. Configure the acquisition trigger input to trigger from an NPN (current sinking) or PNP (current sourcing) device.

Specification	Description
Voltage	ON: 15 to 28 VDC (24 VDC nominal) OFF: 0 to 5 VDC
Current (Typical)	4 mA to 7.5 mA OFF: < 830 $\mu$ A for < 5VDC input Resistance: ~6 kOhms
Delay	190 $\mu$ s maximum latency between leading edge of trigger and start of acquisition, when trigger debounce is set to zero. Input pulse should be a minimum of 1ms wide.

- To trigger from an NPN type photoelectric sensor or PLC output, connect COMMON IN to +24VDC and connect TRIGGER to the output of the photoelectric sensor. When the output turns ON, it pulls TRIGGER down to 0VDC, turning the opto-coupler ON.
- To trigger from a PNP photoelectric sensor or PLC output, connect TRIGGER to the output of the photoelectric sensor and connect COMMON IN to 0VDC. When the output turns ON, it pulls TRIGGER up to +24VDC, turning the opto-coupler ON.

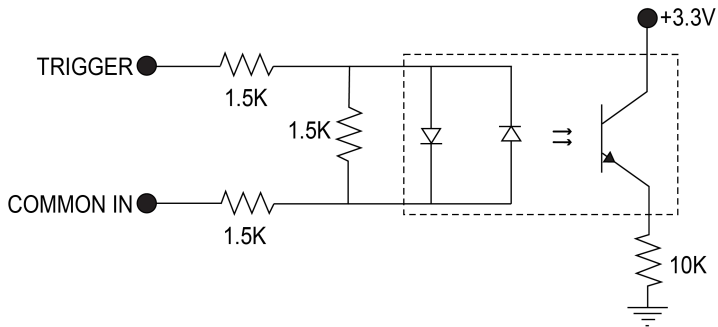

26.4V Max. across input pins

## Power On the Vision System

When power is supplied to the 3D-A1000 by the Breakout cable, the vision system powers on. There is no dedicated power switch for the 3D-A1000.

When power is supplied, the Power LED on top of the unit will light green.

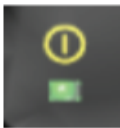

**WARNING:** Do not look directly into the infrared projector during operation.

---

# Install Software and Documentation

To configure your vision system, install the In-Sight VC Explorer software on a networked PC.

Using In-Sight VC Explorersoftware, you develop 2D and 3D vision solutions that run independently, without a PC, on the vision system.

## Log on to the Vision System

1. Select the 3D-A1000 vision system you want to configure from the **Camera Pane** on the left, based on device name or MAC address.
2. Click the **Connect** button.



**Note:** If needed, click the **Utilities** bar and select from one of the options to configure the selected vision system. See the *In-Sight<sup>®</sup> 3D User Guide*, available from the Help menu of the software, for a complete description of all available utilities.

# In-Sight 3D-A1000 Series Vision System Specifications

Specification	3D-A1000
Image Type	Monochrome and 3D
Job/Program Memory	8 GB
Image Processing Memory	2 GB
Acquisition Rate	4 Hz
Clearance Distance	400 mm
Measurement Range (MR)	1600 mm
Near FOV	420 x 300 mm
Far FOV	2100 x 1450 mm
2D Camera Resolution	1280 x 960
Repeatability Z (sigma)	3 mm at 1 m
3D Data Points Per Acquisition	>35,000
Built-in I/O	1 dedicated trigger, 3 inputs, 2 outputs
Industrial M12 Connectors	2: 1 Power / IO, 1 GigE Ethernet
Dimensions	140 mm (5.51 in) x 75 mm (2.95 in) x 45 mm (1.77 in)
Weight	485 g (17.11 oz)

<b>Specification</b>	<b>3D-A1000</b>
Operating Temperature	0° C to 40° C (32° F to 104° F)
Storage Temperature	-10° C to 60° C (14° F to 140° F)
Operating Humidity	<80% (non-condensing)
Protection	IP65
Shock	11 Gs (10 ms half-sinusoidal pulse)
Vibration	8 Gs (10 -500 Hz for 30 minutes)
Power	24 VDC (22 - 26 VDC) 3A MAX, 1A RMS 10 W AVERAGE

Copyright © 2019  
Cognex Corporation. All Rights Reserved.