

## In-Sight<sup>®</sup> 3D-A1000 Series Vision System Reference Guide



2024 January 15  
Revision: 24.1.0.1

COGNEX

# Table of Contents

<b>Table of Contents</b> .....	<b>2</b>
<b>Legal Notices</b> .....	<b>3</b>
<b>Regulations and Conformity</b> .....	<b>4</b>
China RoHS .....	5
For European Community Users .....	5
Laser Information .....	6
Laser Information .....	6
<b>Precautions</b> .....	<b>7</b>
<b>Symbols</b> .....	<b>8</b>
<b>Introduction</b> .....	<b>9</b>
Support .....	9
System Requirements .....	9
Standard Components .....	9
Accessories .....	10
Cables .....	10
Mounting Brackets .....	10
Connectors and Indicators .....	11
Working Distances and Fields of View .....	12
<b>Installation</b> .....	<b>13</b>
Mount the Vision System .....	14
Install the Mounting Bracket .....	14
Connect the Ethernet Cable .....	14
Connect the Breakout Cable .....	14
Install a Hardware Trigger, Encoder or Strobe .....	15
Power On the Vision System .....	15
Log on to the Vision System .....	16
<b>Specifications</b> .....	<b>17</b>
In-Sight 3D-A1000 Series Vision System Specifications .....	17
Acquisition Trigger Input .....	18
Ethernet Cable .....	19
Breakout Cable .....	20
<b>Dimensions</b> .....	<b>21</b>
<b>Maintenance</b> .....	<b>22</b>
Clean the Housing .....	22
Clean the Image Sensor Windows .....	22

# Legal Notices

The software described in this document is furnished under license, and may be used or copied only in accordance with the terms of such license and with the inclusion of the copyright notice shown on this page. Neither the software, this document, nor any copies thereof may be provided to, or otherwise made available to, anyone other than the licensee. Title to, and ownership of, this software remains with Cognex Corporation or its licensor. Cognex Corporation assumes no responsibility for the use or reliability of its software on equipment that is not supplied by Cognex Corporation. Cognex Corporation makes no warranties, either express or implied, regarding the described software, its merchantability, non-infringement or its fitness for any particular purpose.

The information in this document is subject to change without notice and should not be construed as a commitment by Cognex Corporation. Cognex Corporation is not responsible for any errors that may be present in either this document or the associated software.

Companies, names, and data used in examples herein are fictitious unless otherwise noted. No part of this document may be reproduced or transmitted in any form or by any means, electronic or mechanical, for any purpose, nor transferred to any other media or language without the written permission of Cognex Corporation.

Copyright © 2019. Cognex Corporation. All Rights Reserved.

Portions of the hardware and software provided by Cognex may be covered by one or more U.S. and foreign patents, as well as pending U.S. and foreign patents listed on the Cognex web site at: [cognex.com/patents](http://cognex.com/patents).

---

The following are registered trademarks of Cognex Corporation:

Cognex, 2DMAX, Advantage, AlignPlus, Assemblyplus, Check it with Checker, Checker, Cognex Vision for Industry, Cognex VSOC, CVL, DataMan, DisplayInspect, DVT, EasyBuilder, Hotbars, IDMax, In-Sight, Laser Killer, MVS-8000, OmniView, PatFind, PatFlex, PatInspect, PatMax, PatQuick, SensorView, SmartView, SmartAdvisor, SmartLearn, UltraLight, Vision Solutions, VisionPro, VisionView

The following are trademarks of Cognex Corporation:

The Cognex logo, 1DMax, 3D-Locate, 3DMax, BGAll, CheckPoint, Cognex VSoC, CVC-1000, FFD, iLearn, In-Sight (design insignia with cross-hairs), In-Sight 2000, InspectEdge, Inspection Designer, MVS, NotchMax, OCRMax, PatMax RedLine, ProofRead, SmartSync, ProfilePlus, SmartDisplay, SmartSystem, SMD4, VisiFlex, Xpand



Portions copyright © Microsoft Corporation. All rights reserved.

Portions copyright © MadCap Software, Inc. All rights reserved.

Other product and company trademarks identified herein are the trademarks of their respective owners.

# Regulations and Conformity

**Note:** For the most current CE declaration and regulatory conformity information, see the Cognex support site: [cognex.com/support](http://cognex.com/support).

Safety and Regulatory	
Manufacturer	Cognex Corporation One Vision Drive Natick, MA 01760 USA
	In-Sight 3D-A1000 Series: Regulatory Model R00093 This is a class A product. In a domestic environment this product may cause radio interference in which case the user may be required to take immediate measures. This equipment complies with the essential requirements of the EU Directive 2014/30/EU. Declarations are available from your local representative.
EU RoHS	Compliant to the most recent applicable directive.
FCC	FCC Part 15, Class A This equipment has been tested and found to comply with the limits for a Class A digital device, pursuant to part 15 of the FCC Rules. These limits are designed to provide reasonable protection against harmful interference when the equipment is operated in a commercial environment. This equipment generates, uses, and can radiate radio frequency energy and, if not installed and used in accordance with the instruction manual, may cause harmful interference to radio communications. Operation of this equipment in a residential area is likely to cause harmful interference in which case the user will be required to correct the interference at his own expense.
Laser Safety Certification	IEC 60825-1 US FDA CDRH Filing
Korea 	In-Sight 3D-A1000: Regulatory Model R00093: R-R-CGX-R00093 This device is certified for office use only and if used at home, there can be frequency interference problems.
NRTL	TÜV SÜD SCC/NRTL OSHA Scheme for UL/CAN 61010-1.
CB	TÜV SÜD, IEC/EN 61010-1. CB report available upon request.

## China RoHS



Part Name 部件名称	Hazardous Substances 有害物质					
	Lead (Pb) 铅	Mercury (Hg) 汞	Cadmium (Cd) 镉	Hexavalent Chromium (Cr (VI)) 六价铬	Polybrominated biphenyls (PBB) 多溴联苯	Polybrominated diphenyl ethers (PBDE) 多溴二苯醚
Regulatory Model R00093	X	O	O	O	O	O

This table is prepared in accordance with the provisions of SJ/T 11364.

这个标签是根据 SJ/T 11364 的规定准备的。

O: Indicates that said hazardous substance contained in all of the homogeneous materials for this part is below the limit requirement of GB / T26572 - 2011.

表示本部件所有均质材料中含有的有害物质低于 GB / T26572 - 2011 的限量要求。

X: Indicates that said hazardous substance contained in at least one of the homogeneous materials used for this part is above the limit requirement of GB / T26572 - 2011.

表示用于本部件的至少一种均质材料中所含的危害物质超过 GB / T26572 - 2011 的限制要求。

## For European Community Users

Cognex complies with Directive 2012/19/EU OF THE EUROPEAN PARLIAMENT AND OF THE COUNCIL of 4 July 2012 on waste electrical and electronic equipment (WEEE).

This product has required the extraction and use of natural resources for its production. It may contain hazardous substances that could impact health and the environment, if not properly disposed.

In order to avoid the dissemination of those substances in our environment and to diminish the pressure on the natural resources, we encourage you to use the appropriate take-back systems for product disposal. Those systems will reuse or recycle most of the materials of the product you are disposing in a sound way.



The crossed out wheeled bin symbol informs you that the product should not be disposed of along with municipal waste and invites you to use the appropriate separate take-back systems for product disposal.

If you need more information on the collection, reuse, and recycling systems, please contact your local or regional waste administration.

You may also contact your supplier for more information on the environmental performance of this product.

## Laser Information

**Note:** The information in this section applies to 3D-A1000 systems of type 821-10158-001.

**WARNING:** Laser Radiation, Avoid Direct Eye Exposure. Class 1 Laser Product. Failure to follow these instructions may cause serious injury.

Cognex Corporation places the following label on the head of every vision system:

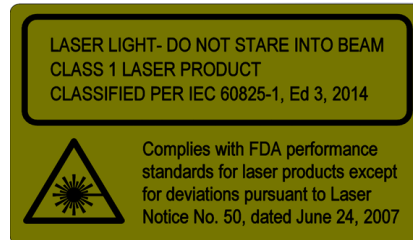

Compliance with FDA performance standards for laser products except for deviations pursuant to Laser notice No.50, dated June 24, 2007. This device has been tested in accordance with IEC 60825-1 Edition 3, and has been certified to be under the limits of a Class I Laser product.

**CAUTION:** Use of controls or adjustments or performance of procedures other than those specified herein may result in hazardous radiation exposure.

## Laser Information

**Note:** The information in this section applies to 3D-A1000 systems of type 821-10158-002.

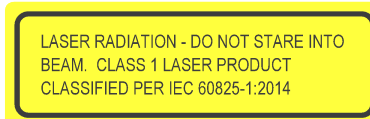

Laser Characteristic	Value
Maximum output power	2 W
Pulse duration	10 $\mu$ s to 10 ms
Emitted wavelength	850 nm
Classification	Classified per IEC60825-1:2014

# Precautions

To reduce the risk of injury or equipment damage, observe the following precautions when you install the Cognex product:

- The vision system requires a UL or NRTL listed power supply with a 24VDC output that meets the rating requirements below. Any other voltage creates a risk of fire or shock and can damage the components. Applicable national and local wiring standards and rules must be followed.
- The power supply must be capable of supplying a current of 3A MAX with 1A RMS.
- Turn off the 24VDC power supply before connecting or disconnecting the power cable.
- Route cables and wires away from high-current wiring or high-voltage power sources to reduce the risk of damage or malfunction from the following causes: over-voltage, line noise, electrostatic discharge (ESD), power surges, or other irregularities in the power supply.
- Do not install Cognex products where they are exposed to environmental hazards such as excessive heat, dust, moisture, humidity, impact, vibration, corrosive substances, flammable substances, or static electricity.
- Changes or modifications not expressly approved by the party responsible for regulatory compliance could void the user's authority to operate the equipment.
- Include service loops with cable connections.
- Ensure that the cable bend radius begins at least six inches from the connector. Cable shielding can be degraded or cables can be damaged or wear out faster if a service loop or bend radius is tighter than 10X the cable diameter.
- This device should be used in accordance with the instructions in this manual.
- All specifications are for reference purposes only and can change without notice.

# Symbols

The following symbols indicate safety precautions and supplemental information:

---

 **WARNING:** This symbol indicates a hazard that could cause death, serious personal injury or electrical shock.

---

---

 **CAUTION:** This symbol indicates a hazard that could result in property damage.

---

---

 **Note:** This symbol indicates additional information about a subject.

---

---

 **Tip:** This symbol indicates suggestions and shortcuts that might not otherwise be apparent.

---

# Introduction

The 3D-A1000 vision system is capable of 2D/3D image acquisition, image processing, and sending vision inspection results to other devices (for example, PLCs) on connected networks.

The vision system uses two fixed-focus vision systems to capture both 2D and 3D information. One vision system captures a monochromatic 2D image. The second vision system captures a proprietary IR pattern projected onto objects and surfaces, which is used to construct a three-dimensional point cloud of the objects and surfaces visible to the device. Both vision systems used fixed-focus lenses, which define the range of the device.

## Support

Many information resources are available to help you use the vision system:

- The *In-Sight® 3D User Guide*, provided with In-Sight software.
- On-demand training: [cognex.com/on-demand-training.aspx](http://cognex.com/on-demand-training.aspx).
- The In-Sight online support site: [cognex.com/support/insight](http://cognex.com/support/insight).

## System Requirements

To configure your vision system, you will need, at minimum:

- Cognex 24 Volt DC Power Supply
- Ethernet X-coded M12-8 to RJ-45 Cable
- Combination power / Breakout cable

## Standard Components

**Note:**



- Cables are sold separately.
- If a standard component is missing or damaged, immediately contact your Cognex Authorized Service Provider (ASP) or Cognex Technical Support.





Component	Description
Vision System	Provides image acquisition, vision processing and Ethernet connectivity.



## Accessories

You can purchase the following components separately. For a list of options and accessories, contact your local Cognex sales representative.

### Cables

Accessory	Product Number	Illustration
Power and I/O Breakout Cable, M12-12 to Flying Lead	CCB-PWRIO- xx (straight, xx specifies length: 5m, 10m, 15m)	
	CCB-PWRIO-xxR (right-angled, xx specifies length: 5m, 10m, 15m)	
Ethernet Cable, X-coded M12-8 to RJ-45	CCB-84901-2001-xx (straight, xx specifies length: 2m, 5m, 10m, 15m, 30m)	
	CCB-84901-2002-xx (right-angled, xx specifies length: 2m, 5m, 10m)	

### Mounting Brackets



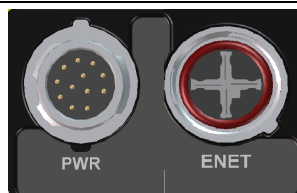

Accessory	Product Number	Illustration
Universal mounting bracket	DM100-UBRK-000	
Pivot mounting bracket	DM100-PIVOTM-00	

## Connectors and Indicators

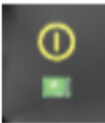
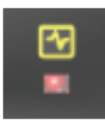

Connector	Function
PWR Connector	Connects the Breakout cable, which provides connections to an external power supply, the acquisition trigger input, general-purpose inputs, and high-speed outputs. For more information, See <a href="#">Breakout Cable on page 20</a> Alternately, this connector is used to attach the I/O Module cable to a compatible In-Sight I/O module, which adds general-purpose discrete I/O.
ENET Connector	Connects the Ethernet cable, which provides 10/100/1000 Ethernet connectivity.



Indicator	Function
Power LED	 <p>The green LED illuminates to indicate that the vision system is powered on.</p>
Acquisition LED	 <p>The orange LED illuminates when the IR Projector is on during image acquisition.</p>
Pass / Fail LED	 <p>Green (pass) or red (fail) when implemented.</p>
Network LED	 <p>The yellow LED flashes to indicate network activity.</p>
Status LED	 <ul style="list-style-type: none"> <li>Blinking green indicates that the vision system is restarting.</li> <li>Solid green indicates the vision system is ready.</li> <li>No light indicates vision system is offline and unavailable.</li> <li>Red indicates an error. The red light displays until the error logs are accessed.</li> </ul>

## Working Distances and Fields of View

The 3D-A1000 supports a three-dimensional working space defined by three properties:

1. The **Measurement Range** is the height of the volume where the 3D-A1000 can detect 3D features.
2. The **Clearance Distance** is the distance from the bottom of the 3D-A1000 to the top of the Measurement Range.
3. The **Field of View (FOV)** is the size of the plane at any point within the Measurement Range. The Field of View grows as the Measurement Range extends from the 3D-A1000. Be aware, however, that features physically closer to the sensor generate more accurate measurements.

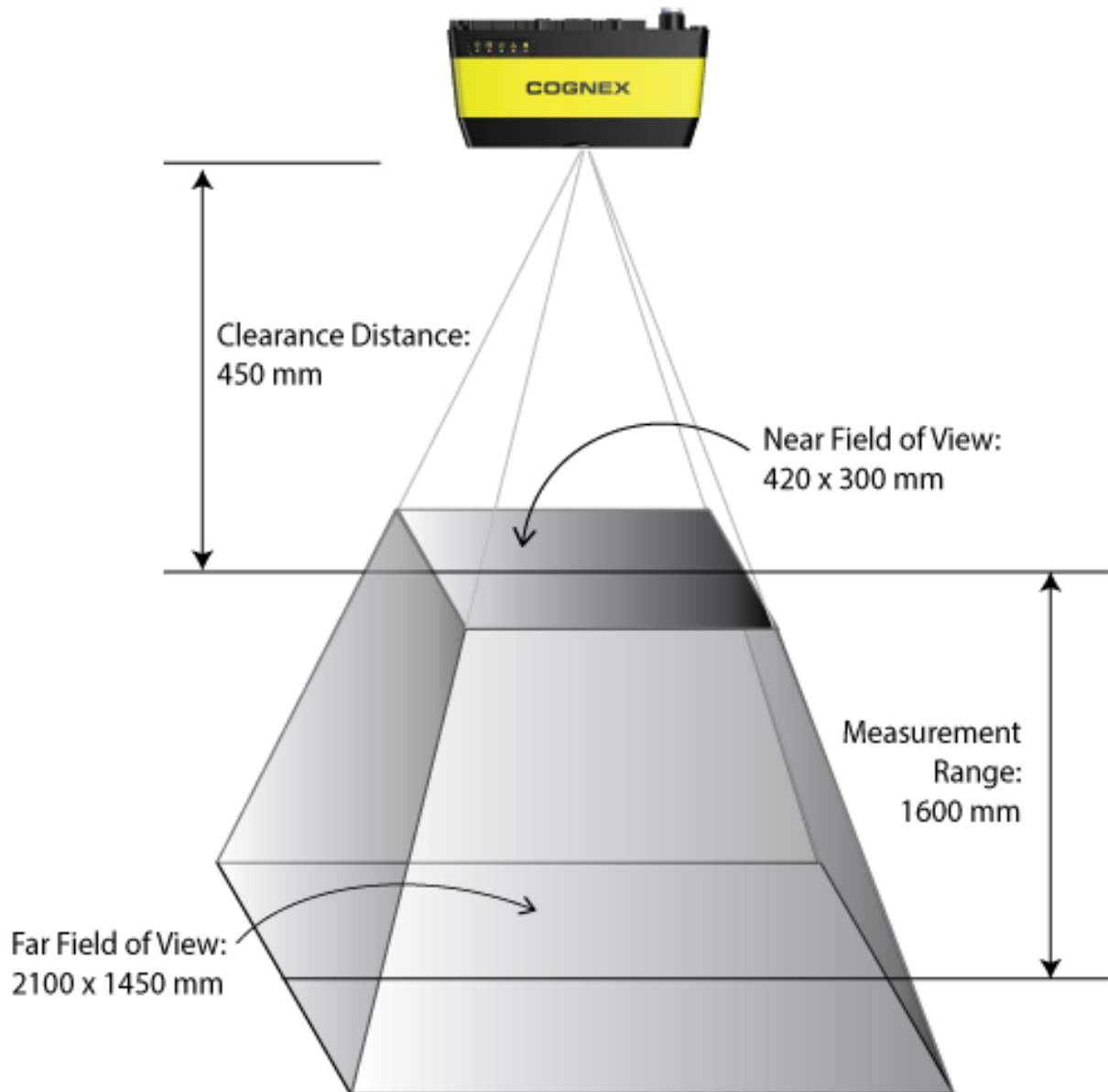

No calibration is needed of either the 2D or 3D components after a 3D-A1000 has been deployed.

# Installation

For a list of options and accessories, contact your Cognex sales representative.

For more information on the software used for configuring the 3D vision system and the vision application, refer to the *In-Sight 3D User Guide* installed with the In-Sight VC Explorer software.

**Note:** Cables are sold separately.

**CAUTION:** All cable connectors are keyed to fit the connectors on the vision system. Do not force the connections or damage may occur.



## Mount the Vision System

The vision system provides mounting holes for attachment to a mounting surface.

**CAUTION:** The vision system should be grounded, either by mounting the vision system to a fixture that is electrically grounded or by attaching a wire from the vision system's mounting fixture to frame ground or Earth ground. If a ground wire is used, it should be attached to one of the four mounting points on the back plate of the vision system and not to the mounting points on the front of the vision system.

1. Align the holes on the mounting surface with the mounting holes on the vision system.
2. Insert the M3 screws into the mounting holes and tighten using a 2.5mm hex wrench; the maximum torque is 0.90 Nm (8 in-lb).

**Note:** The maximum insertion depth of the M3 screws is 3.5mm in the rear housing and 3.75mm in the front housing, plus the thickness of the mounting material used.

## Install the Mounting Bracket

The 3D-A1000 supports various mounting brackets. Contact your sales representative or Cognex Support to select the one best suited to your operational environment.

When mounting the vision system to the mounting bracket, use the M3 screws supplied with the mounting kit.

Allowing the mounting screws to bottom in the mounting hole can damage the vision system.

**CAUTION:** The vision system case should be grounded, either by mounting the vision system to a fixture that is electrically grounded or by attaching a wire from the vision system chassis to frame ground or Earth ground. If a ground wire is used, attach the ground wire to one of the four mounting points on the back plate of the vision system.

1. Align the mounting bracket with the mounting holes on the vision system.
2. Insert the M3 screws into the mounting holes and tighten using a 2.5mm hex wrench; the maximum torque is 0.90 Nm (8 in-lb).

## Connect the Ethernet Cable

**CAUTION:** The Ethernet cable shield must be grounded at the far end. The device this cable is plugged into (typically a switch or router) should have a grounded Ethernet connector. A digital voltmeter should be used to validate the grounding. If the far end device is not grounded, a ground wire should be added in compliance with local electrical codes.

1. Connect the M12 connector of the Ethernet cable to the vision system's ENET connector.
2. Connect the RJ-45 connector of the Ethernet cable to a switch/router or PC, as applicable.

## Connect the Breakout Cable

**CAUTION:** To reduce emissions, connect the far end of the breakout cable shield to frame ground.

**WARNING:** Wires 2 (White/Yellow) and 3 (Brown) are NC and must never be connected to anything.

I/O wiring or adjustments to I/O devices should be performed when the vision system is not receiving power. You can cut exposed wires short or trim wire ends. You also can tie the wires back if you use a tie made of non-conductive material. Keep bare wires separated from the +24VDC wire.

1. Verify that the 24VDC power supply is unplugged and not receiving power.
2. Optionally, connect the I/O wires to an appropriate device.
3. Attach the +24VDC (Red) wires and digital GND (Black) wires of the Breakout cable to the corresponding terminals on the power supply.

---

 **CAUTION:** Never connect voltages other than 24VDC. Always observe the polarity shown.

---

4. Connect the M12 connector of the Breakout cable to the PWR connector of the vision system.

---

 **WARNING:** Keep bare wires separated from each other and from the 24V power wires.

---

## Install a Hardware Trigger, Encoder or Strobe

The topic [Breakout Cable on page 20](#) describes the Breakout cable to connect the 3D-A1000 to external devices such as hardware triggers and strobe lights.

The 3D-A1000 supports single-channel encoders with a frequency of 1 kHz. For encoders, use the following leads from the Breakout cable:

- INPUT 1 (Violet)
- COMMON IN (White/Violet)

---

 **Note:** 3D-A1000 supports encoders only on INPUT 1.

---

Use the following leads for an external hardware trigger:

- TRIGGER (Orange)
- Common In (White/Violet)

See the topic [Acquisition Trigger Input on page 18](#) for details on the trigger line.

Use OUT 0 for general output or strobe.

- OUT 0 (Blue)
- Common out (Green)

---

 **Note:** 3D-A1000 supports strobes only on OUT 0.

---

## Power On the Vision System

When power is supplied to the 3D-A1000 by the Breakout cable, the vision system powers on. There is no dedicated power switch for the 3D-A1000.

When power is supplied, the Power LED on top of the unit will light green.

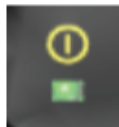

---

 **WARNING:** Do not look directly into the infrared projector during operation.

---

## Log on to the Vision System

1. Select the 3D-A1000 vision system you want to configure from the **Camera Pane** on the left, based on device name or MAC address.
2. Click the **Connect** button.

 **Note:** If needed, click the **Utilities** bar and select from one of the options to configure the selected vision system. See the *In-Sight® 3D User Guide*, available from the Help menu of the software, for a complete description of all available utilities.

# Specifications

The following sections list general specifications for the vision system.

## In-Sight 3D-A1000 Series Vision System Specifications

Specification	3D-A1000
Image Type	Monochrome and 3D
Job/Program Memory	8 GB
Image Processing Memory	2 GB
Acquisition Rate	4 Hz
Clearance Distance	400 mm
Measurement Range (MR)	1600 mm
Near FOV	420 x 300 mm
Far FOV	2100 x 1450 mm
2D Camera Resolution	1280 x 960
Repeatability Z (sigma)	3 mm at 1 m
3D Data Points Per Acquisition	>35,000
Built-in I/O	1 dedicated trigger, 3 inputs, 2 outputs
Industrial M12 Connectors	2: 1 Power / IO, 1 GigE Ethernet
Dimensions	140 mm (5.51 in) x 75 mm (2.95 in) x 45 mm (1.77 in)
Weight	485 g (17.11 oz)
Operating Temperature	0° C to 40° C (32° F to 104° F)
Storage Temperature	-10° C to 60° C (14° F to 140° F)
Operating Humidity	<80% (non-condensing)
Protection	IP65
Shock	11 Gs (10 ms half-sinusoidal pulse)
Vibration	8 Gs (10 -500 Hz for 30 minutes)
Power	24 VDC (22 - 26 VDC) 3A MAX, 1A RMS 10 W AVERAGE

## Acquisition Trigger Input

The 3D-A1000 features one acquisition trigger input, which is optically isolated. Configure the acquisition trigger input to trigger from an NPN (current sinking) or PNP (current sourcing) device.

Specification	Description
Voltage	ON: 15 to 28 VDC (24 VDC nominal) OFF: 0 to 5 VDC
Current (Typical)	4 mA to 7.5 mA OFF: < 830µA for < 5VDC input Resistance: ~6 kOhms
Delay	190µs maximum latency between leading edge of trigger and start of acquisition, when trigger debounce is set to zero. Input pulse should be a minimum of 1ms wide.

- To trigger from an NPN type photoelectric sensor or PLC output, connect COMMON IN to +24VDC and connect TRIGGER to the output of the photoelectric sensor. When the output turns ON, it pulls TRIGGER down to 0VDC, turning the opto-coupler ON.
- To trigger from a PNP photoelectric sensor or PLC output, connect TRIGGER to the output of the photoelectric sensor and connect COMMON IN to 0VDC. When the output turns ON, it pulls TRIGGER up to +24VDC, turning the opto-coupler ON.

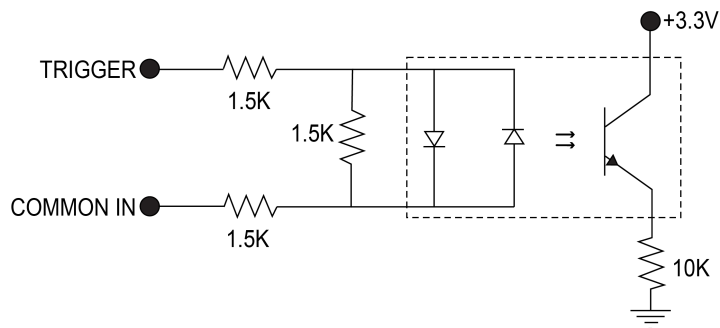

26.4V Max. across input pins

## Ethernet Cable

The Ethernet cable provides Ethernet connectivity to the vision system.

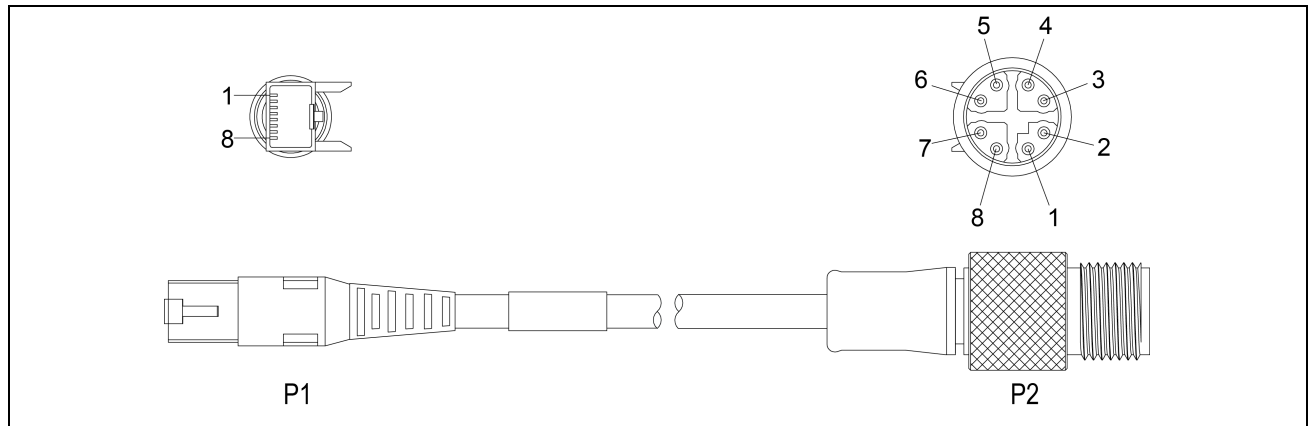

P1 Pin Number	Wire Color	Signal Name	P2 Pin Number
1	White/Orange	TxRx A +	1
2	Orange	TxRx A -	2
3	White/Green	TxRx B +	3
4	Blue	TxRx C +	8
5	White/Blue	TxRx C -	7
6	Green	TxRx B -	4
7	White/Brown	TxRx D +	5
8	Brown	TxRx D -	6

**CAUTION:** The Ethernet cable shield must be grounded at the far end. Whatever this cable is plugged into (typically a switch or router) should have a grounded Ethernet connector. A digital voltmeter should be used to validate the grounding. If the far end device is not grounded, a ground wire should be added in compliance with local electrical codes.

**Note:**

- Cables are sold separately.
- The wiring for this cable follows standard industrial Ethernet M12 specifications. It differs from the 568B standard.



## Breakout Cable

The Breakout cable provides connections to an external power supply, the acquisition trigger input, general-purpose inputs, and high-speed outputs. The vision system's Breakout cable can be connected to devices, such as a trigger sensor or strobe light. The Breakout cable is not terminated.

OUT 0 and OUT 1 can be used for either NPN or PNP lines.

**Note:** OUT 0 can be either general output or strobe. Strobes must be configured on this wire.

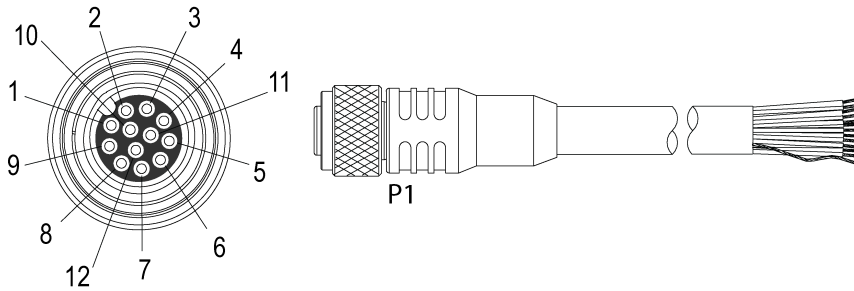

Pin#	Signal Names	Wire Color
1	INPUT 2	Yellow
2	NC	White/Yellow
3	NC	Brown
4	INPUT 3	White/Brown
5	INPUT 1	Violet
6	COMMON IN	White/Violet
7	+24VDC	Red
8	GND	Black
9	COMMON OUT	Green
10	TRIGGER	Orange
11	OUT 0	Blue
12	OUT 1	Grey

**Note:**

- Cables are sold separately.



- You can cut exposed wires short or trim wire ends. You also can tie the wires back if you use a tie made of non-conductive material. Keep bare wires separated from the +24VDC wire.
- Perform wiring or adjustments to I/O devices when the vision system is not receiving power.

# Dimensions

**Note:** Dimensions are in millimeters [inches] and are for reference purposes only.

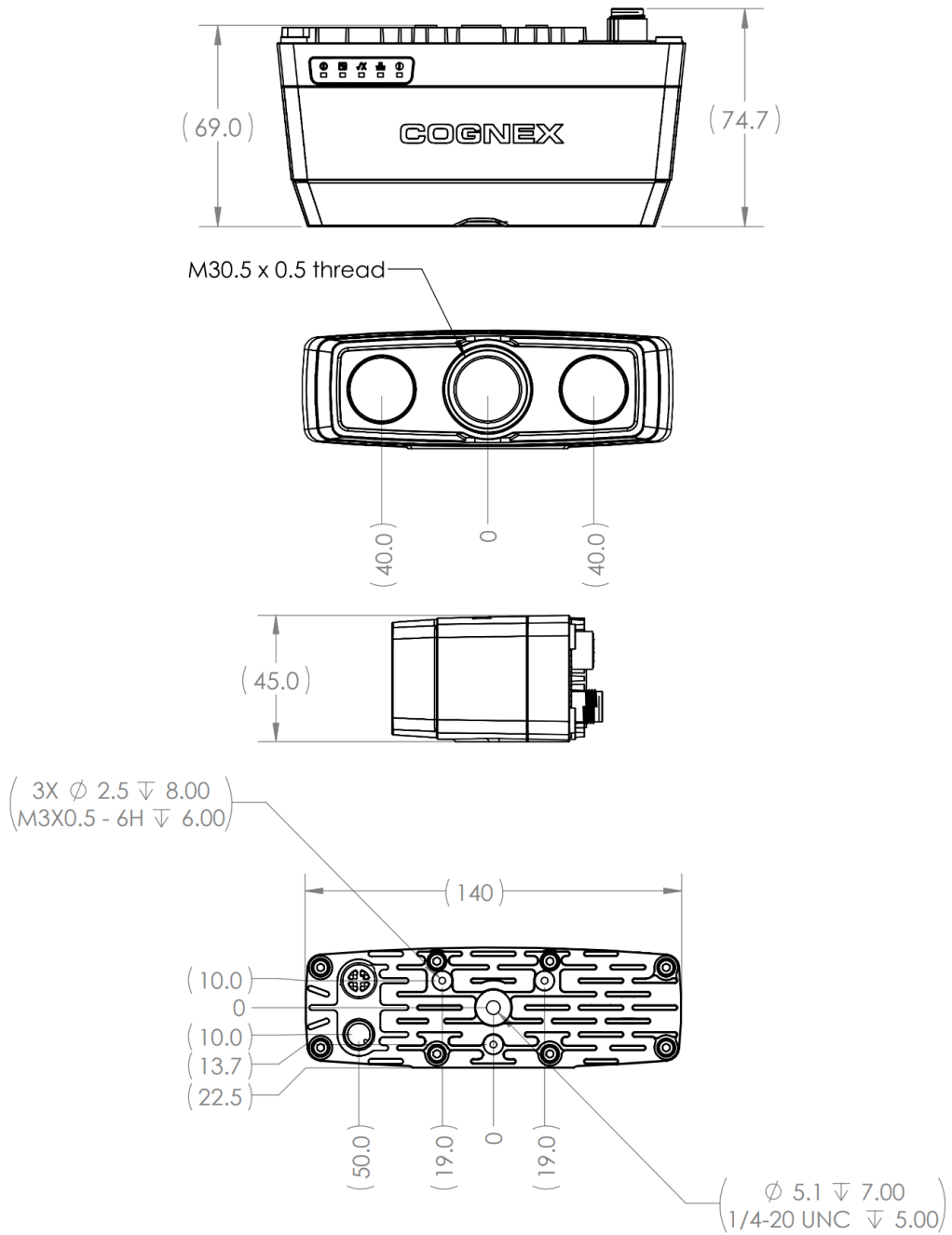

# Maintenance

Use the information in this section to maintain your vision system and get support when you require it.

## Clean the Housing

To clean the outside of the vision system housing, use a small amount of mild detergent cleaner or isopropyl alcohol on a cleaning cloth. Do not pour the cleaner on the vision system housing.



**CAUTION:** Do not attempt to clean any In-Sight product with harsh or corrosive solvents, including lye, methyl ethyl ketone (MEK) or gasoline.

---

## Clean the Image Sensor Windows

To remove dust from the outside of the image sensor windows, use a pressurized air duster. The air must be free of oil, moisture or other contaminants that could remain on the glass and possibly degrade the image. Do not touch the glass windows. If oil or smudges remain, use a cotton bud and alcohol (ethyl, methyl, or isopropyl) to clean the windows. Do not pour the alcohol on the windows.

