

In-Sight[®] 8900 Series Reference Manual



2025 January 27

Legal Notices

The software described in this document is furnished under license, and may be used or copied only in accordance with the terms of such license and with the inclusion of the copyright notice shown on this page. Neither the software, this document, nor any copies thereof may be provided to, or otherwise made available to, anyone other than the licensee. Title to, and ownership of, this software remains with Cognex Corporation or its licensor. Cognex Corporation assumes no responsibility for the use or reliability of its software on equipment that is not supplied by Cognex Corporation. Cognex Corporation makes no warranties, either express or implied, regarding the described software, its merchantability, non-infringement or its fitness for any particular purpose.

The information in this document is subject to change without notice and should not be construed as a commitment by Cognex Corporation. Cognex Corporation is not responsible for any errors that may be present in either this document or the associated software.

Companies, names, and data used in examples herein are fictitious unless otherwise noted. No part of this document may be reproduced or transmitted in any form or by any means, electronic or mechanical, for any purpose, nor transferred to any other media or language without the written permission of Cognex Corporation.

Copyright © 2024. Cognex Corporation. All Rights Reserved.

Portions of the hardware and software provided by Cognex may be covered by one or more U.S. and foreign patents, as well as pending U.S. and foreign patents listed on the Cognex web site at: cognex.com/patents.

The following are registered trademarks of Cognex Corporation:

Cognex, 2DMAX, Advantage, AlignPlus, Assemblyplus, Check it with Checker, Checker, Cognex Vision for Industry, Cognex VSOC, CVL, DataMan, DisplayInspect, DVT, EasyBuilder, Hotbars, IDMax, In-Sight, Laser Killer, MVS-8000, OmniView, PatFind, PatFlex, PatInspect, PatMax, PatQuick, SensorView, SmartView, SmartAdvisor, SmartLearn, UltraLight, Vision Solutions, VisionPro, VisionView

The following are trademarks of Cognex Corporation:

The Cognex logo, 1DMax, 3D-Locate, 3DMax, BGAll, CheckPoint, Cognex VSoC, CVC-1000, FFD, iLearn, In-Sight (design insignia with cross-hairs), In-Sight 2000, InspectEdge, Inspection Designer, MVS, NotchMax, OCRMax, PatMax RedLine, ProofRead, SmartSync, ProfilePlus, SmartDisplay, SmartSystem, SMD4, VisiFlex, Xpand

Portions copyright © Microsoft Corporation. All rights reserved.

Portions copyright © MadCap Software, Inc. All rights reserved.

Other product and company trademarks identified herein are the trademarks of their respective owners.

Precautions

To reduce the risk of injury or equipment damage, observe the following precautions when you install the Cognex product:

- The vision system requires a UL or NTRL listed power supply with a 24 VDC output that meets the following rating requirements:
 - At least 24 V DC (+/- 10%) output connection using a UL or NTRL listed LPS or NEC Class 2 power supplyAny other voltage creates a risk of fire or shock and can damage the components. Applicable national and local wiring standards and rules must be followed.
- This product is intended for industrial use in automated manufacturing or similar applications.
- The safety of any system incorporating this product is the responsibility of the assembler of the system.
- Do not install Cognex products where they are exposed to environmental hazards such as excessive heat, dust, moisture, humidity, impact, vibration, corrosive substances, flammable substances, or static electricity.
- Route cables and wires away from high-current wiring or high-voltage power sources to reduce the risk of damage or malfunction from the following causes: over-voltage, line noise, electrostatic discharge (ESD), power surges, or other irregularities in the power supply.
- Do not expose the image sensor to laser light. Image sensors can be damaged by direct, or reflected, laser light. If your application requires laser light that might strike the image sensor, use a lens filter at the corresponding laser wavelength. For suggestions, contact your local integrator or application engineer.
- This product does not contain user-serviceable parts. Do not make electrical or mechanical modifications to product components. Unauthorized modifications can void your warranty.
- Changes or modifications not expressly approved by the party responsible for regulatory compliance could void the user's authority to operate the equipment.
- Include service loops with cable connections.
- Ensure that the cable bend radius begins at least six inches from the connector. Cable shielding can be degraded or cables can be damaged or wear out faster if a service loop or bend radius is tighter than 10X the cable diameter.
- This device should be used in accordance with the instructions in this manual.
- All specifications are for reference purposes only and can change without notice.

Symbols

The following symbols indicate safety precautions and supplemental information:

 **WARNING:** This symbol indicates a hazard that could cause death, serious personal injury or electrical shock.

 **CAUTION:** This symbol indicates a hazard that could result in property damage.

 **Note:** This symbol indicates additional information about a subject.

 **Tip:** This symbol indicates suggestions and shortcuts that might not otherwise be apparent.

Table of Contents

Legal Notices	2
Precautions	3
Symbols	4
Table of Contents	5
Getting Started	7
About the In-Sight 8900 Series	7
Accessories	8
Lenses	8
Mounting Brackets	9
Cables	10
Setting Up Your In-Sight Vision System	11
Vision System Layout	11
Dimensions	12
In-Sight 8900 Vision System Only	12
In-Sight 8900 with High Speed Liquid Lens Connector	13
In-Sight 8900 with High Speed Liquid Lens Installed	14
Reading Distance and Field of View	15
In-Sight 8900 with 0.5 MP Sensor	15
16 mm Focal Length:	15
25 mm Focal Length:	16
35 mm Focal Length:	17
In-Sight 8900 with 2 MP Sensor	18
16 mm Focal Length:	18
25 mm Focal Length:	19
35 mm Focal Length:	20
In-Sight 8900 with 5 MP Sensor	21
16 mm Focal Length:	21
25 mm Focal Length:	22
35 mm Focal Length:	23
In-Sight 8900 with 12 MP Sensor	24
16 mm Focal Length:	24
25 mm Focal Length:	25
35 mm Focal Length:	26
Install the Mounting Bracket	27
Connecting the Ethernet Cable	28
Connecting the Power and I/O Breakout Cable	29
Using Your In-Sight Vision System	30
Installing In-Sight Vision Suite	30
Trigger Types	31

External Triggers	32
Industrial Protocols	33
Specifications	34
In-Sight 8900 Series Vision System	34
In-Sight 8900 Series Vision System Image Sensor	35
Spectral Response Curves	35
Acquisition Trigger Input	38
High-Speed Outputs	39
Ethernet Cable	40
Breakout Cable	40
Cleaning and Maintenance	42
Clean the Housing	42
Clean the Vision System Image Sensor Window	42
Clean the Vision System Lens Cover	42
Regulations and Conformity	43
中国大陆RoHS (Information for China RoHS Compliance)	44
For European Community Users	44

Getting Started

This section provides general information about the In-Sight 8900 series vision system and the accessories and systems.

About the In-Sight 8900 Series



The In-Sight 8900 series vision systems are high-performance, small form factor vision systems with global shutter. In-Sight 8900 vision systems offer:

- Fast acquisition
- High performance
- Full In-Sight Vision Suite support
- Edge Learning tool support

Accessories

You can purchase the following components separately. For a list of options and accessories, contact your local Cognex sales representative.

Lenses

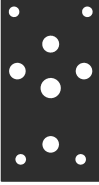
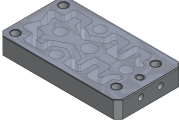

Accessory	Product Number	Illustration	IS8900	IS8902	IS8905	IS8912
6 mm Moritex UR series lens	ML-M0625UR		✓	✓	✓	
8 mm Moritex UR series lens	ML-M0822UR					
12 mm Moritex UR series lens	ML-M1218UR					
16 mm Moritex UR series lens	ML-M1616UR					
25 mm Moritex UR series lens	ML-M2516UR					
35 mm Moritex UR series lens	ML-M3520UR					
50 mm Moritex UR series lens	ML-M5025UR					
16 mm HSSL - high resolution	CLN-C16F65-HSSL-HR		✓	✓	✓	✓
25 mm HSSL - high resolution	CLN-C25F65-HSSL-HR					
35 mm HSSL - high resolution	CLN-C35F06-HSSL-HR					
6 mm Moritex SR series lens	ML-U0618SR-18C					✓
8 mm Moritex SR series lens	ML-U0817SR-18C					
12 mm Moritex SR series lens	ML-U1217SR-18C					
16 mm Moritex SR series lens	ML-U1615SR-18C					
25 mm Moritex SR series lens	ML-U2515SR-18C					
35 mm Moritex SR series lens	ML-U3518SR-18C					
50 mm Moritex SR series lens	ML-U5022SR-18C					

Mounting Brackets

Accessory	Product Number	Illustration
Mounting Bracket	BKT-IS8K-01	
Thermal Cooling Bracket	BKT-IS8K-02	

Cables

Note: Cables are sold separately.

Accessory	Product Number	Illustration
Ethernet Cable, X-coded M12-8 to RJ-45	CCB-84901-2001-xx (straight, xx specifies length: 2m, 5m, 10m, 15m, 30m)	
Ethernet Cable, Robotic X-Coded M12-8 to RJ-45	CCB-84901-2RBT-xx (straight, xx specifies length: 2m, 5m, 10m)	
Breakout cable, M8-8 Flying Lead Cable	CCB-PWRIOM8-S-xx (xx specifies length: 2m, 5m, 10m, 15m)	
M8-5 to M8-8 Adapter Cable	CCB-M8CONVTR	

Setting Up Your In-Sight Vision System

Read this section to learn how the vision system connects to its standard components and accessories.

Vision System Layout

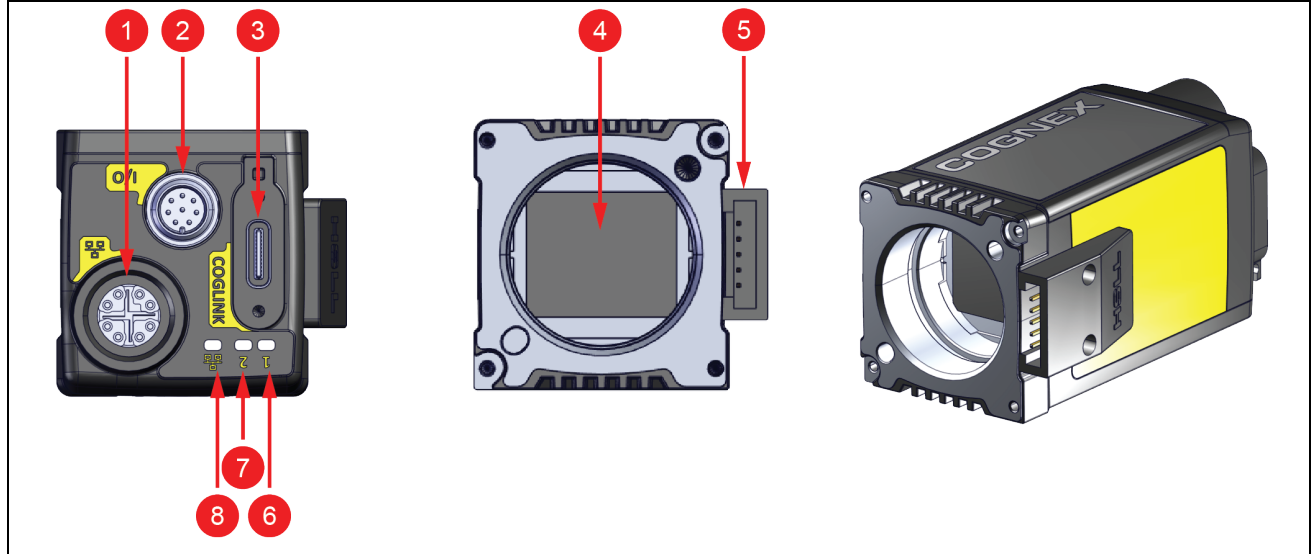

Number	Description
1	Ethernet connector
2	M8x8 Power I/O Breakout cable connector
3	Coglink/USB-C connector
4	Imager/C-mount flange
5	High Speed Liquid Lens connector (optional configuration)
6	LED 1
7	LED 2
8	Ethernet status indicator

Dimensions

The following sections list dimensions of the vision system.

Note:



- Dimensions are in millimeters [inches] and are for reference purposes only.
- All specifications are for reference purposes only and can change without notice.

In-Sight 8900 Vision System Only

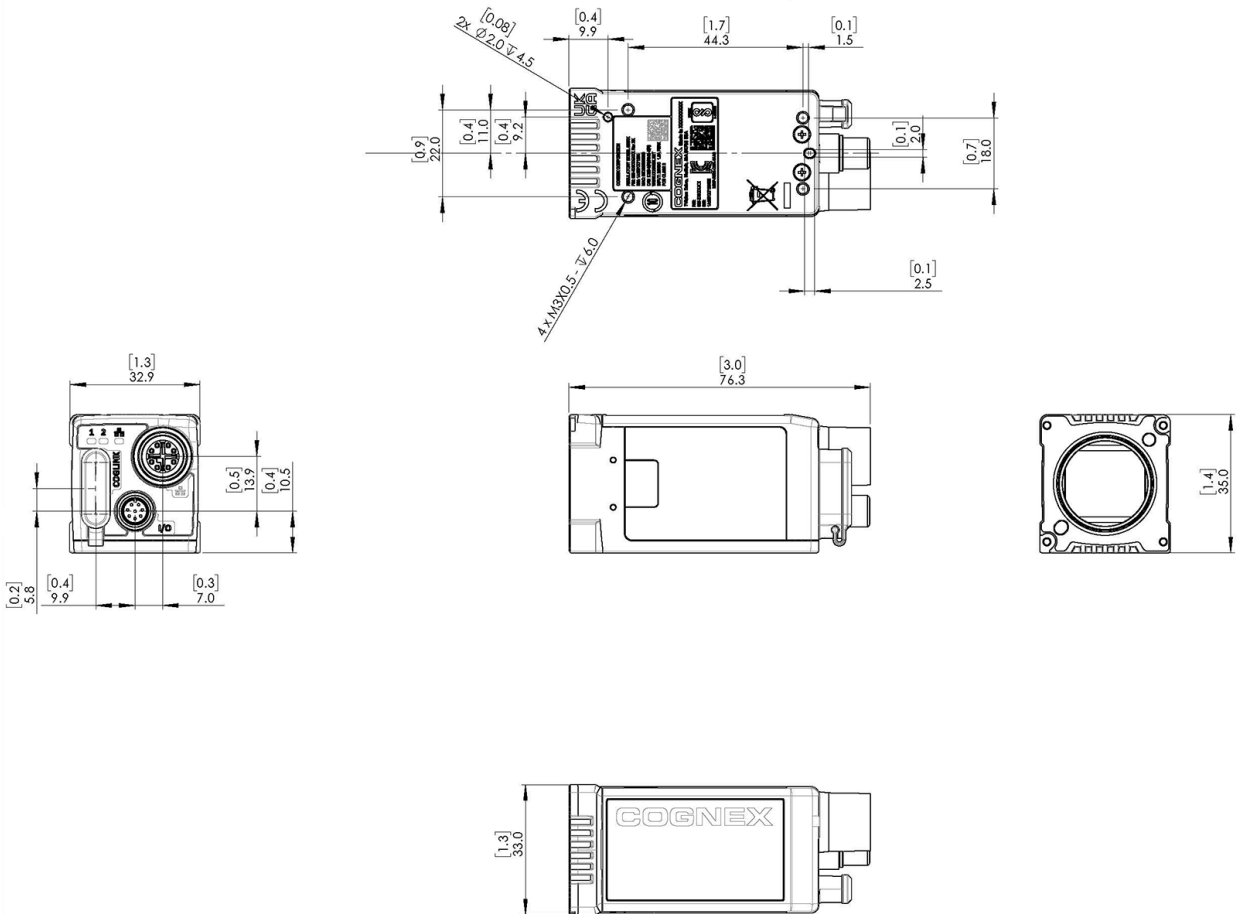

In-Sight 8900 with High Speed Liquid Lens Connector

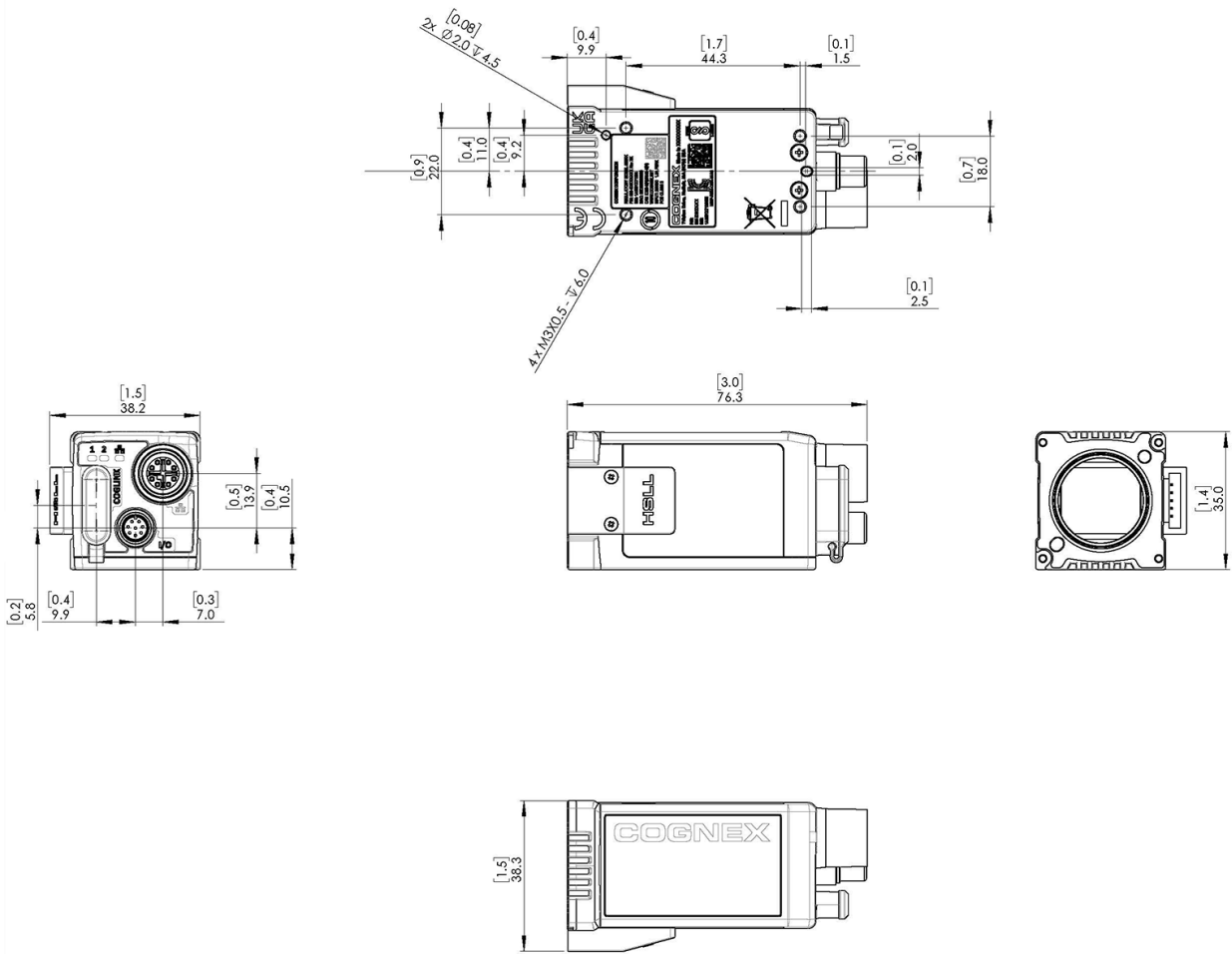

Reading Distance and Field of View

This section provides the Field of View (FoV) values for the various In-Sight 8900 image sensors.

In-Sight 8900 with 0.5 MP Sensor

16 mm Focal Length:

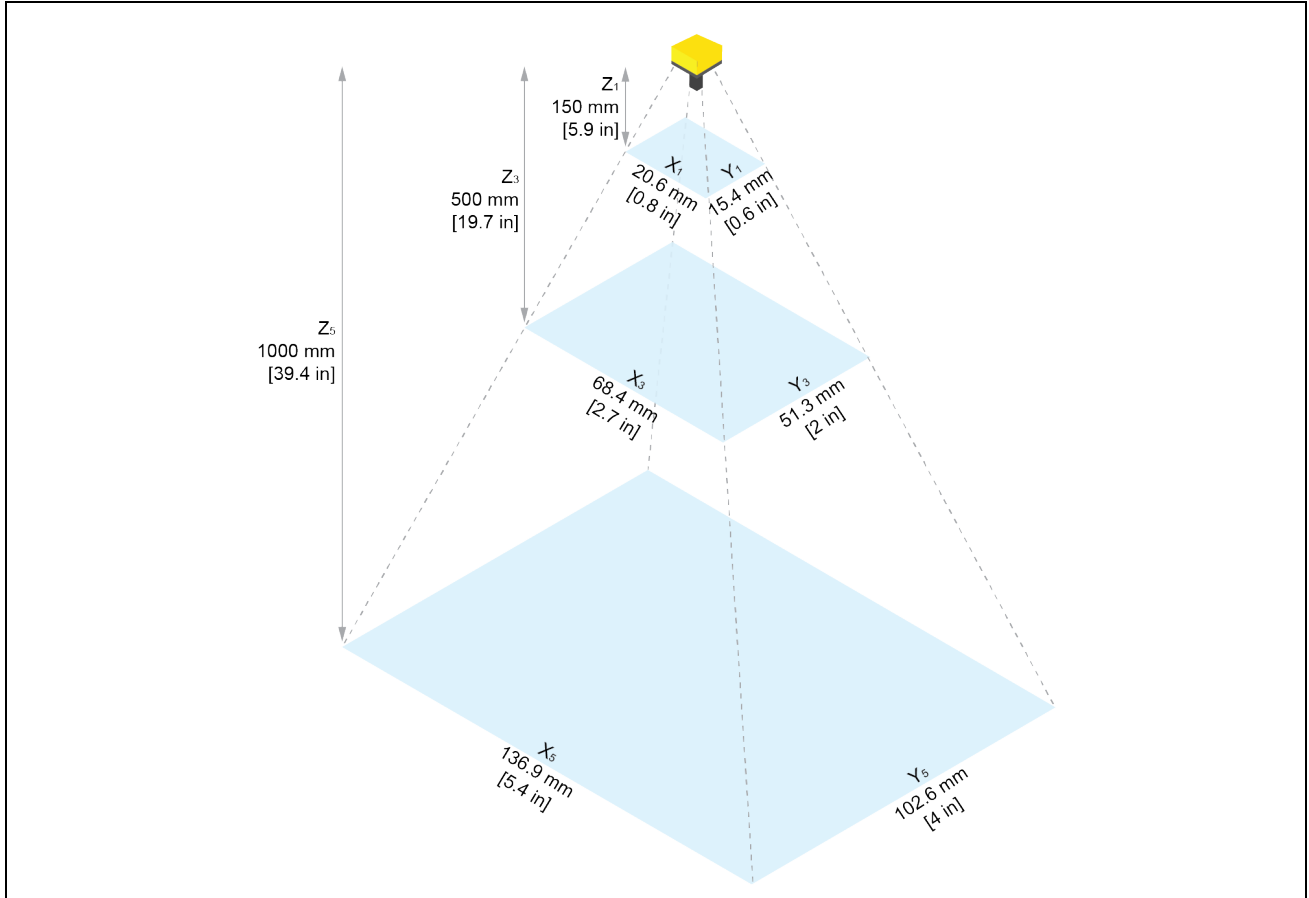

Working Distance	Horizontal Values	Vertical Values	Diagonal Values
150 mm [5.9 in]	20.6 mm [0.8 in]	15.4 mm [0.6 in]	25.7 mm [1 in]
500 mm [19.7 in]	68.4 mm [2.7 in]	51.3 mm [2 in]	85.5 mm [3.4 in]
1000 mm [39.4 in]	136.9 mm [5.4 in]	102.6 mm [4 in]	171.1 mm [6.7 in]

25 mm Focal Length:

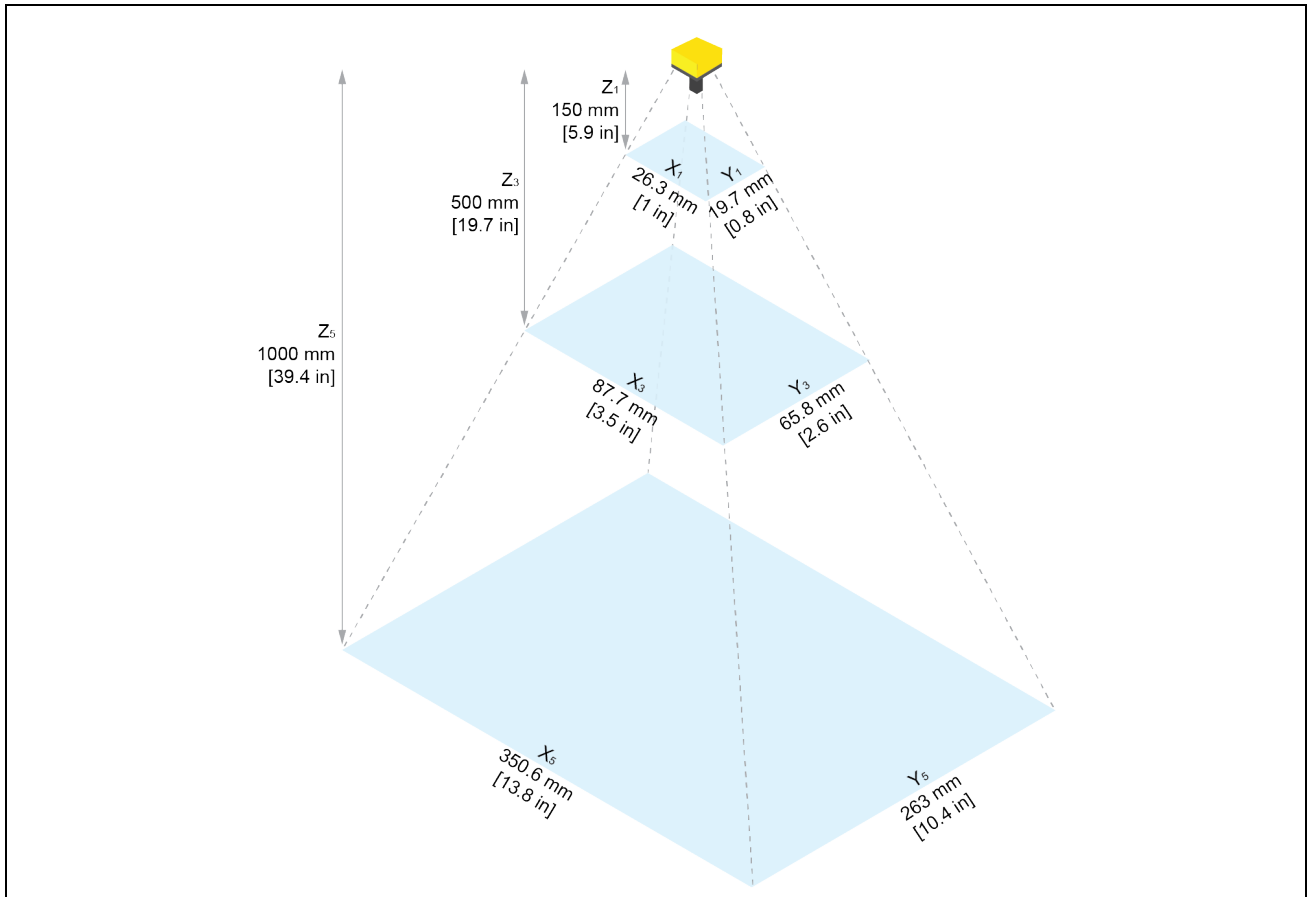

Working Distance	Horizontal Values	Vertical Values	Diagonal Values
150 mm [5.9 in]	26.3 mm [1 in]	19.7 mm [0.8 in]	32.8 mm [1.3 in]
500 mm [19.7 in]	87.7 mm [3.5 in]	65.8 mm [2.6 in]	109.6 mm [4.3 in]
1000 mm [39.4 in]	350.6 mm [13.8 in]	263 mm [10.4 in]	438.3 mm [19 in]

35 mm Focal Length:

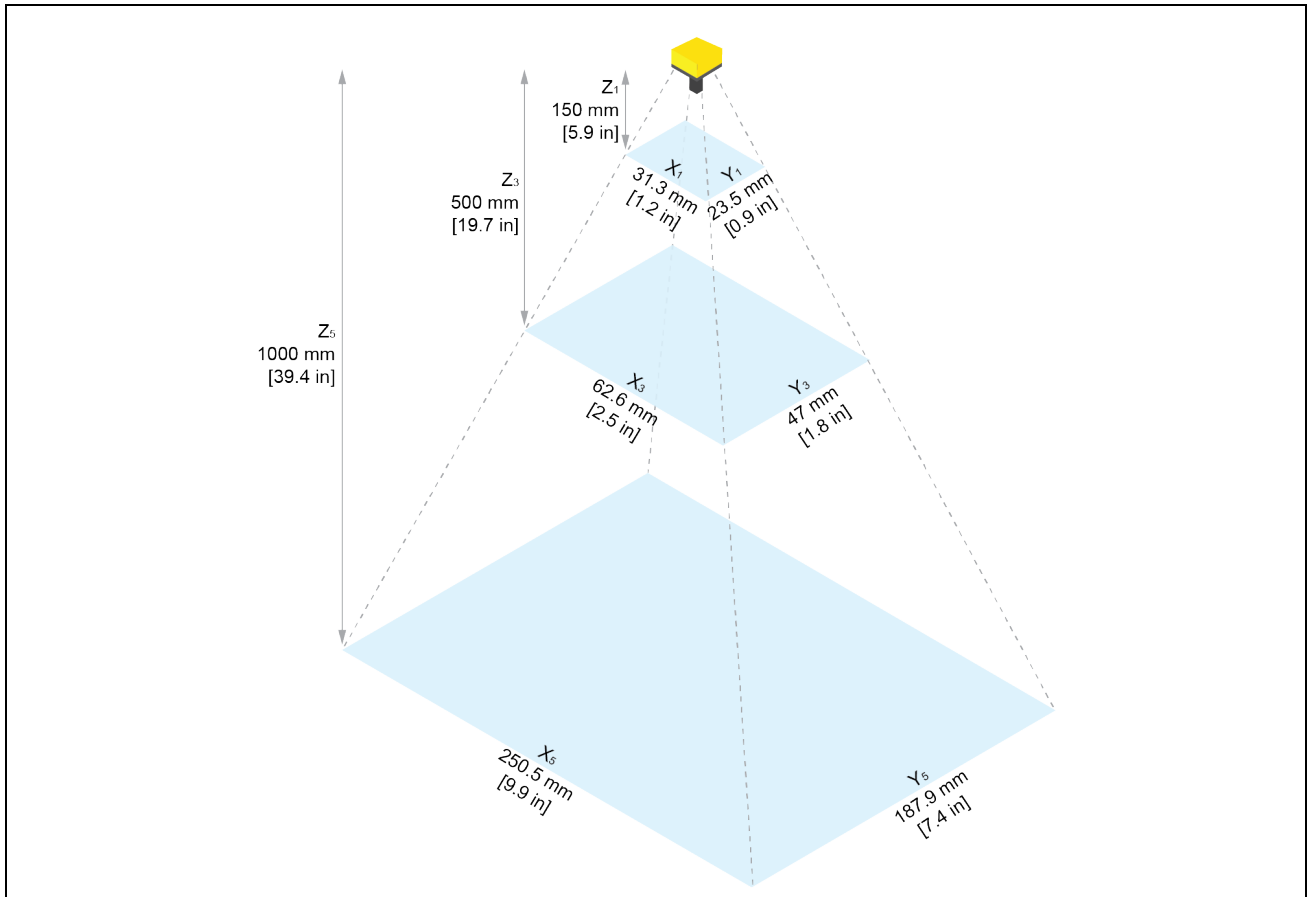

Working Distance	Horizontal Values	Vertical Values	Diagonal Values
150 mm [5.9 in]	31.3 mm [1.2 in]	23.5 mm [0.9 in]	39.1 mm [1.5 in]
500 mm [19.7 in]	62.6 mm [2.5 in]	47 mm [1.8 in]	78.3 mm [3.1 in]
1000 mm [39.4 in]	250.5 mm [9.9 in]	187.9 mm [7.4 in]	313.1 mm [12.3 in]

In-Sight 8900 with 2 MP Sensor

16 mm Focal Length:

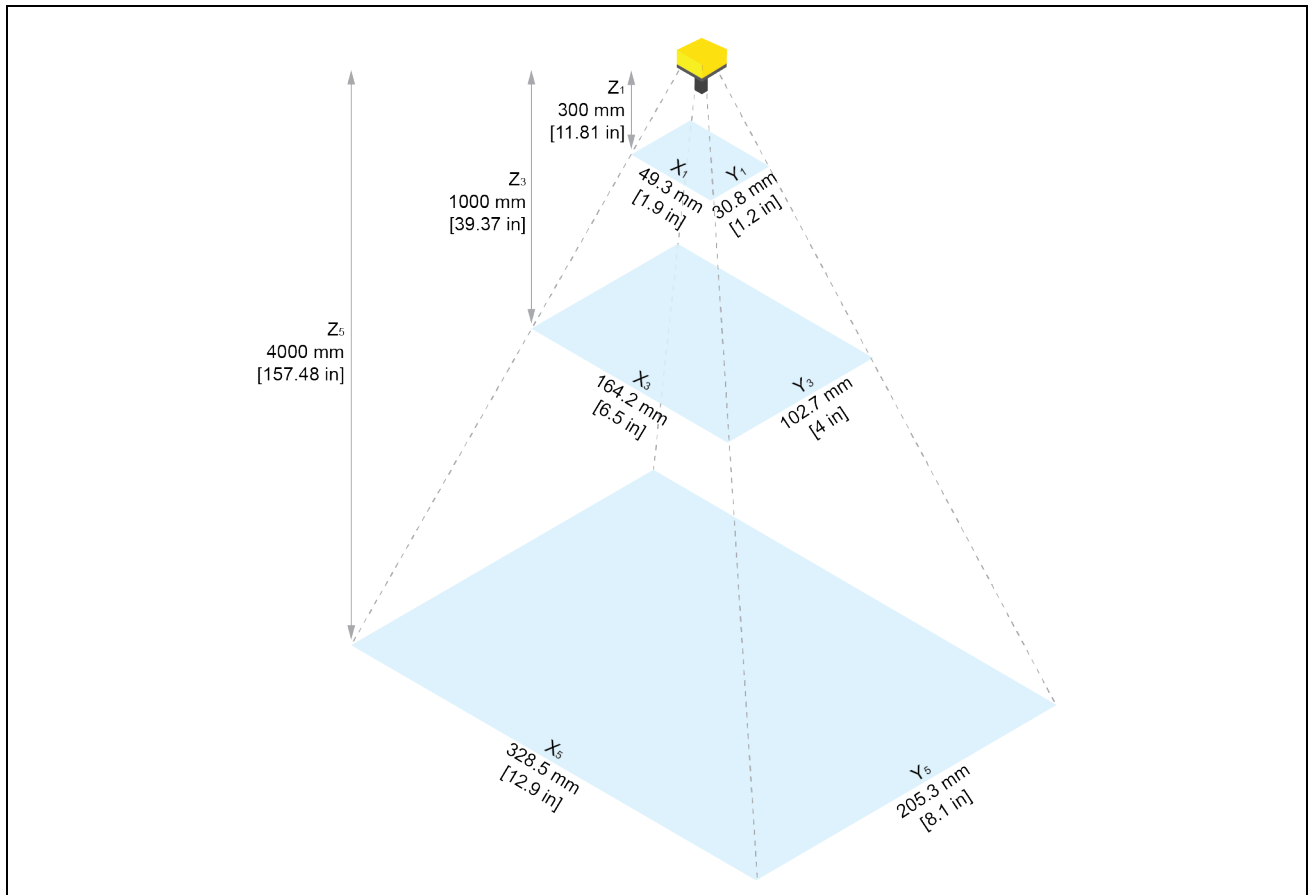

Working Distance	Horizontal Values	Vertical Values	Diagonal Values
150 mm [5.9 in]	49.3 mm [1.9 in]	30.8 mm [1.2 in]	58.1 mm [2.3 in]
500 mm [19.7 in]	164.2 mm [6.5 in]	102.7 mm [4 in]	193.7 mm [7.6 in]
1000 mm [39.4 in]	328.5 mm [12.9 in]	205.3 mm [8.1 in]	387.4 mm [15.3 in]

25 mm Focal Length:

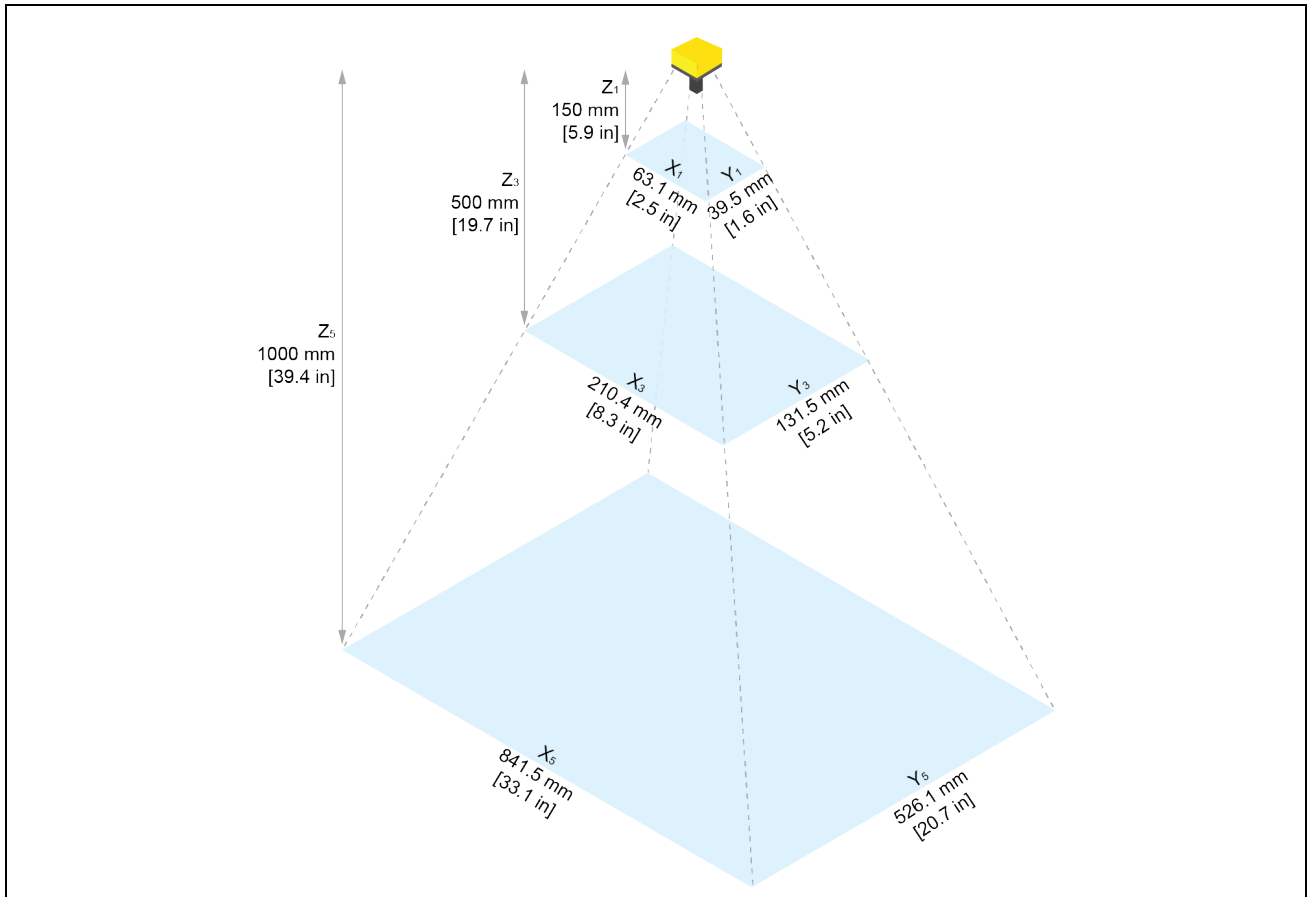

Working Distance	Horizontal Values	Vertical Values	Diagonal Values
150 mm [5.9 in]	63.1 mm [2.5 in]	39.5 mm [1.6 in]	74.4 mm [2-9 in]
500 mm [19.7 in]	210.4 mm [8.3 in]	131.5 mm [5.2 in]	248.1 mm [9.8 in]
1000 mm [39.4 in]	841.5 mm [33.1 in]	526.1 mm [20.7 in]	992.4 mm [39 in]

35 mm Focal Length:

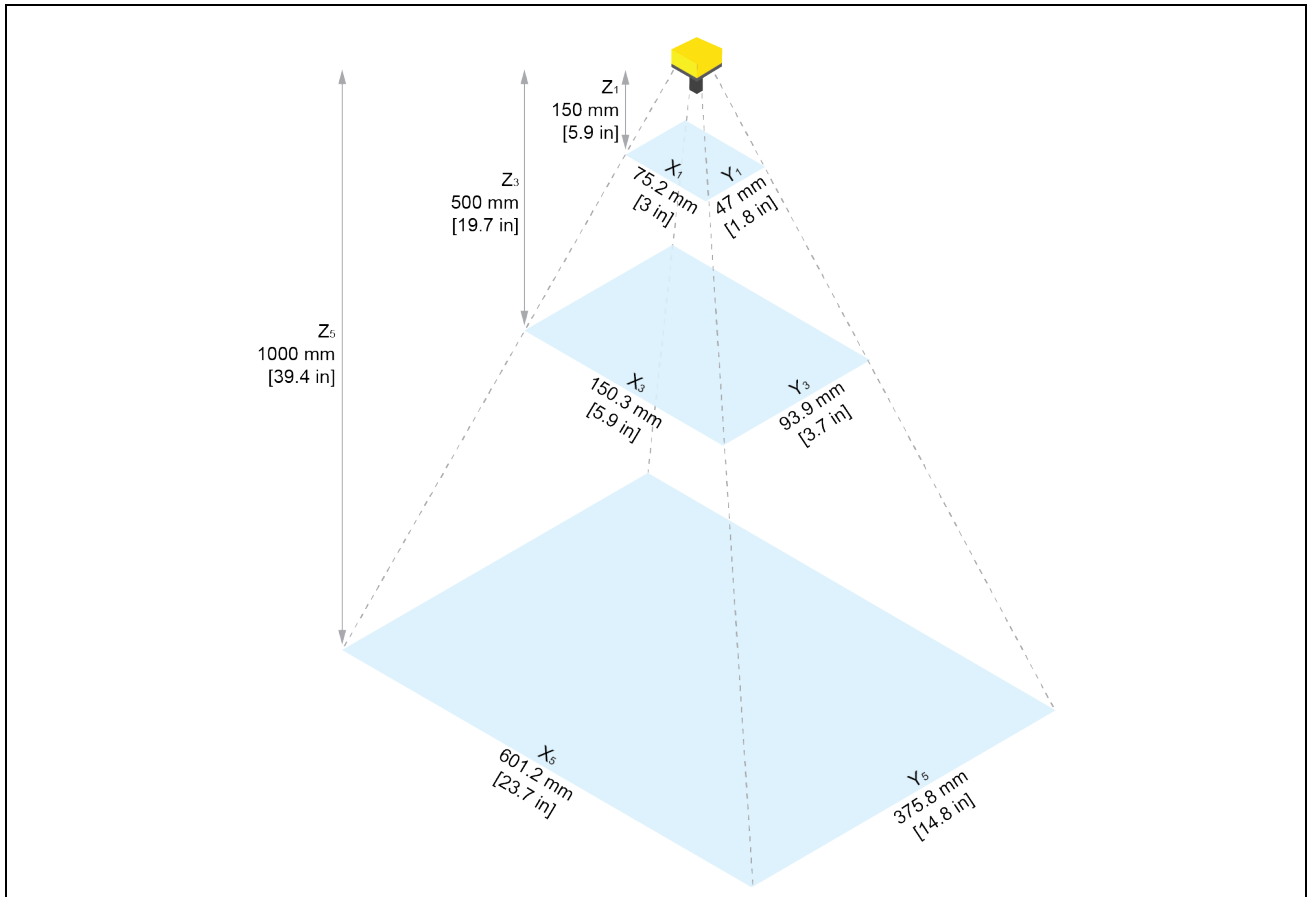

Working Distance	Horizontal Values	Vertical Values	Diagonal Values
150 mm [5.9 in]	75.2 mm [3 in]	47 mm [1.8 in]	88.7 mm [3.5 in]
500 mm [19.7 in]	150.3 mm [5.9 in]	93.9 mm [3.7 in]	177.2 mm [7 in]
1000 mm [39.4 in]	601.2 mm [23.7 in]	375.8 mm [14.9 in]	709 mm [27.9 in]

In-Sight 8900 with 5 MP Sensor

16 mm Focal Length:

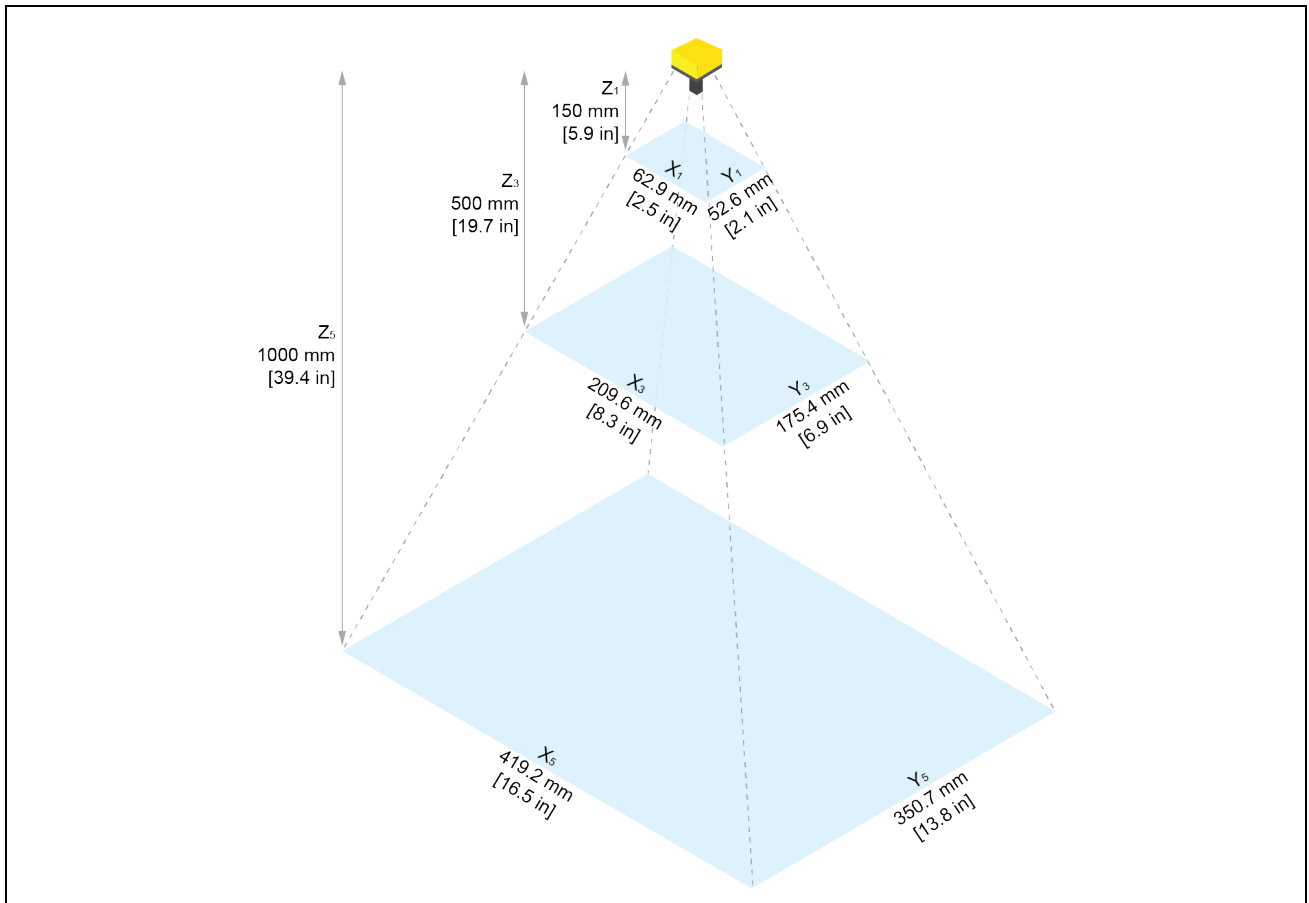

Working Distance	Horizontal Values	Vertical Values	Diagonal Values
150 mm [5.9 in]	62.9 mm [2.5 in]	52.6 mm [2.1 in]	82 mm [3.2 in]
500 mm [19.7 in]	209.6 mm [8.3 in]	175.4 mm [6.9 in]	273.3 mm [10.8 in]
1000 mm [39.4 in]	419.2 mm [16.5 in]	350.7 mm [13.8 in]	546.6 mm [21.5 in]

25 mm Focal Length:

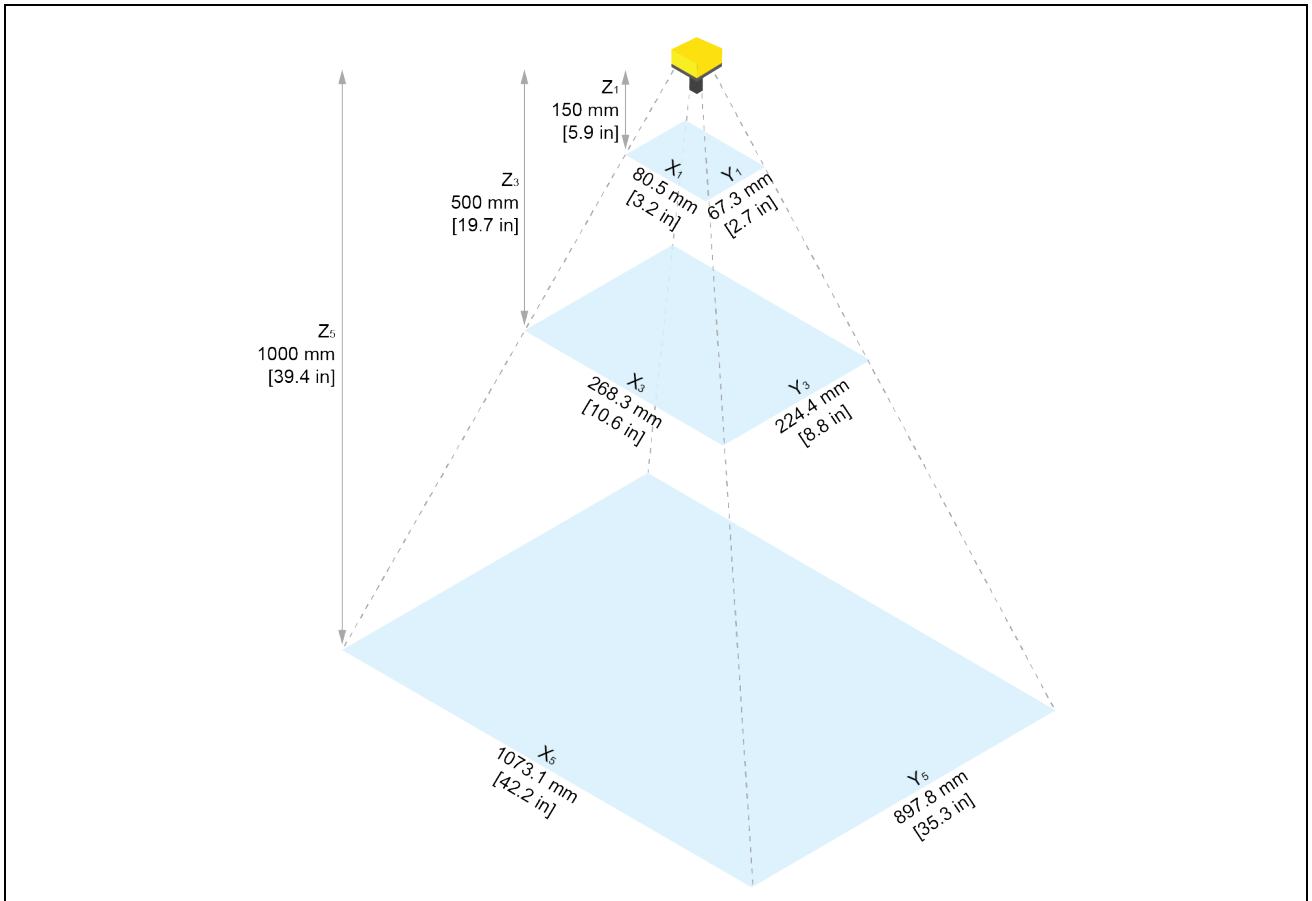

Working Distance	Horizontal Values	Vertical Values	Diagonal Values
150 mm [5.9 in]	80.5 mm [3.2 in]	67.3 mm [2.7 in]	104.9 mm [4.1 in]
500 mm [19.7 in]	268.3 mm [10.6 in]	224.4 mm [8.8 in]	349.8 mm [13.8 in]
1000 mm [39.4 in]	1073.1 mm [42.2 in]	897.8 mm [35.3 in]	1399.1 mm [55.1 in]

35 mm Focal Length:

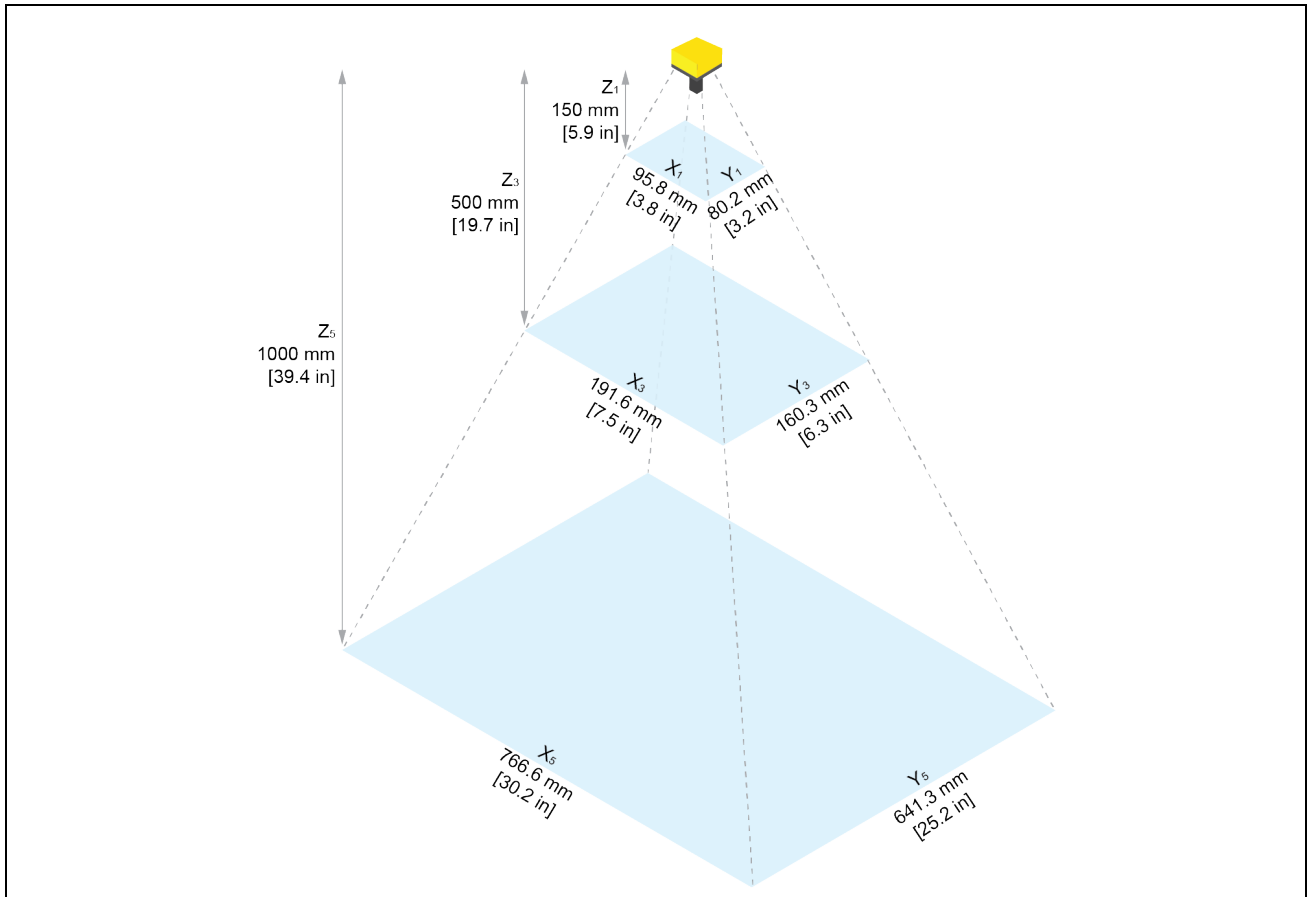

Working Distance	Horizontal Values	Vertical Values	Diagonal Values
150 mm [5.9 in]	95.8 mm [3.8 in]	80.2 mm [3.2 in]	124.9 mm [4.9 in]
500 mm [19.7 in]	191.6 mm [7.5 in]	160.3 mm [6.3 in]	249.8 mm [9.8 in]
1000 mm [39.4 in]	766.6 mm [30.2 in]	641.3 mm [25.2 in]	999.5 mm [39.4 in]

In-Sight 8900 with 12 MP Sensor

16 mm Focal Length:

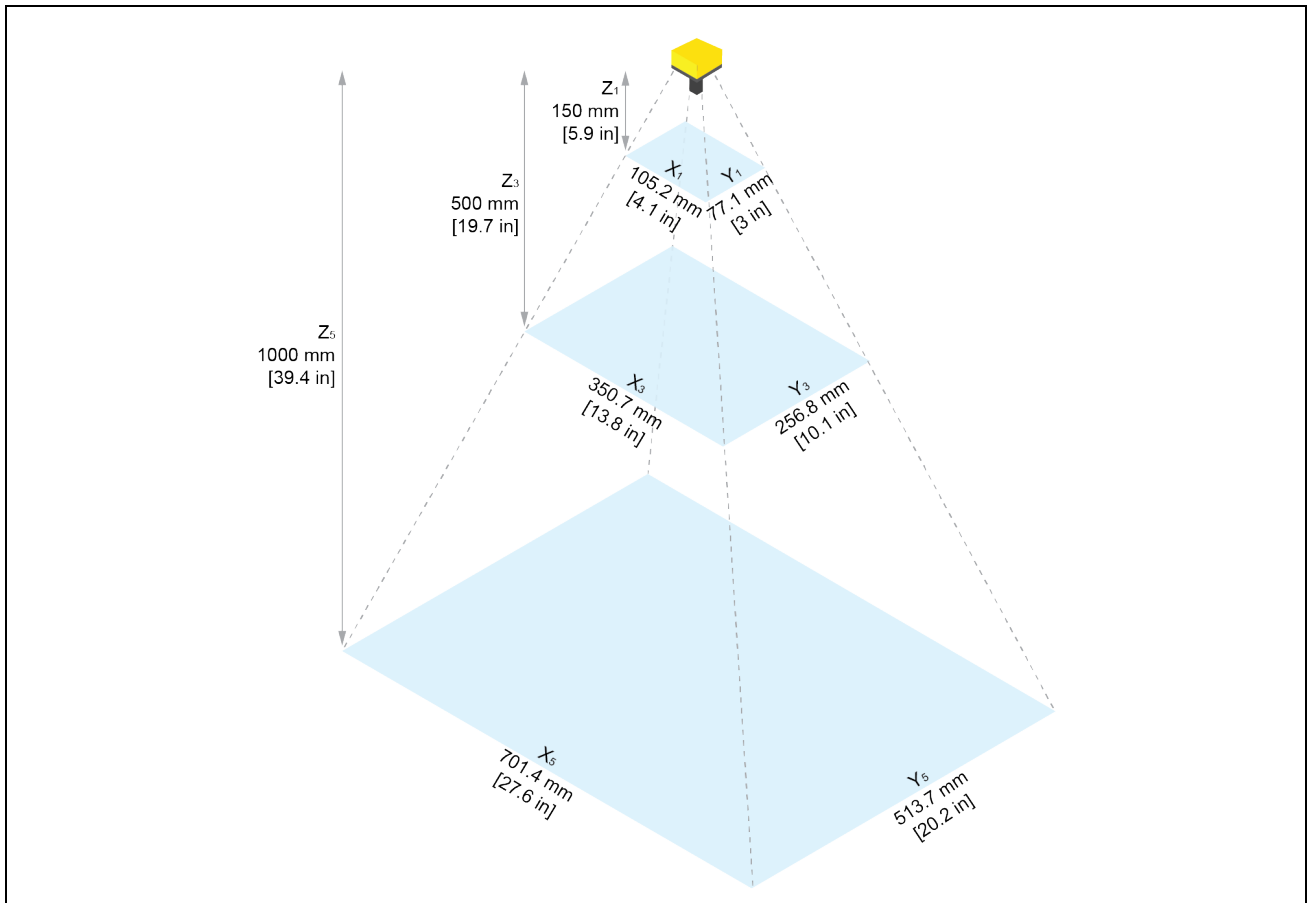

Working Distance	Horizontal Values	Vertical Values	Diagonal Values
150 mm [5.9 in]	105.2 mm [4.1 in]	77.1 mm [3 in]	130.4 mm [5.1 in]
500 mm [19.7 in]	350.7 mm [13.8 in]	256.8 mm [10.1 in]	434.7 mm [17.1 in]
1000 mm [39.4 in]	701.4 mm [27.6 in]	513.7 mm [20.2 in]	869.4 mm [34.2 in]

25 mm Focal Length:

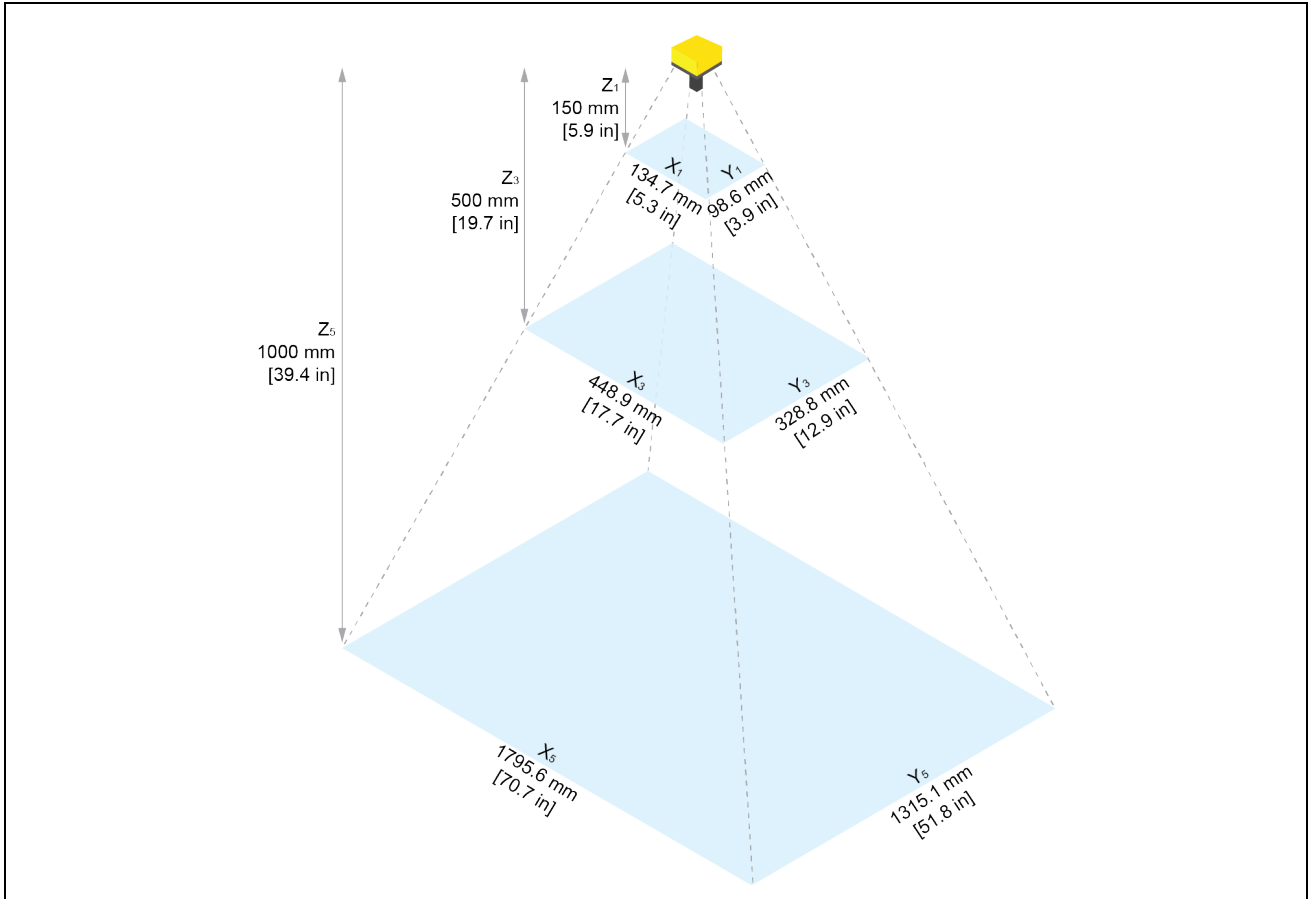

Working Distance	Horizontal Values	Vertical Values	Diagonal Values
150 mm [5.9 in]	134.7 mm [5.3 in]	98.6 mm [3.9 in]	166.9 mm [6.6 in]
500 mm [19.7 in]	448.9 mm [17.7 in]	328.8 mm [12.9 in]	556.4 mm [22 in]
1000 mm [39.4 in]	1795.6 mm [70.7 in]	1315.1 mm [51.8 in]	2225.7 mm [87.6 in]

35 mm Focal Length:

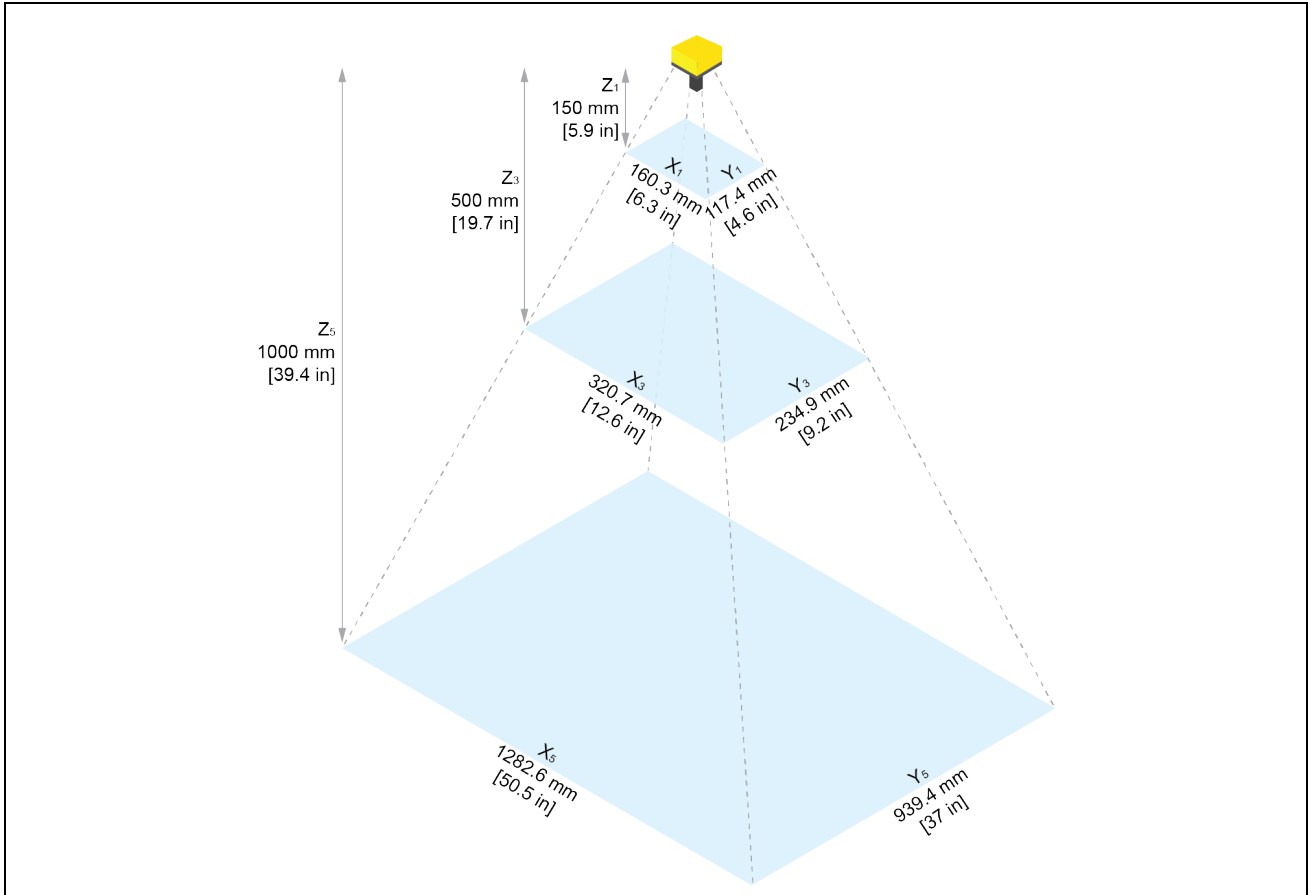

Working Distance	Horizontal Values	Vertical Values	Diagonal Values
150 mm [5.9 in]	160.3 mm [6.3 in]	117.4 mm [4.6 in]	198.7 mm [7.8 in]
500 mm [19.7 in]	320.7 mm [12.6 in]	234.9 mm [9.2 in]	397.6 mm [15.7 in]
1000 mm [39.4 in]	1282.6 mm [50.5 in]	939.4 mm [37 in]	1589.8 mm [62.6 in]

Install the Mounting Bracket

The vision system provides mounting holes for attachment to a mounting surface.

CAUTION: You must ground the vision system, either by mounting the vision system to a fixture that is electrically grounded or by attaching a wire from the mounting fixture on the vision system to frame ground or earth ground. If you use a ground wire, attach the wire to one of the four mounting points on the back plate of the vision system and not to the mounting points on the front of the vision system.

Note: If using the 1/4-20 or M6 mounting holes, the thread length of the screw cannot exceed 8 mm.

1. Align the holes on the mounting surface with the mounting holes on the vision system.
2. Insert the M3 screws into the mounting holes and tighten using a 2.5 mm hex wrench. The maximum torque is 0.3 Nm (2.5 in-lb).

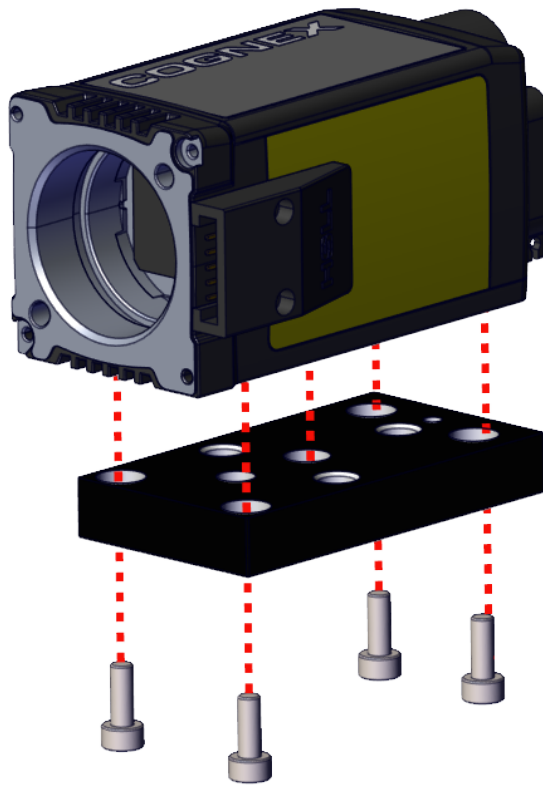

Connecting the Ethernet Cable

CAUTION: The Ethernet cable shield must be grounded at the far end. Whatever this cable is plugged into (typically a switch or router) should have a grounded Ethernet connector. A digital voltmeter should be used to validate the grounding. If the far end device is not grounded, a ground wire should be added in compliance with local electrical codes.



1. Connect the M12 connector of the Ethernet cable to the vision system ENET connector.
2. Connect the RJ-45 connector of the Ethernet cable to a switch/router or PC, as applicable.

Connecting the Power and I/O Breakout Cable

 **CAUTION:** To reduce emissions, connect the far end of the Breakout cable shield to frame ground.

Note:



- Perform wiring or adjustments to I/O devices when the vision system is not receiving power.
- You can clip unused wires short or use a tie made of non-conductive material to tie them back. Keep bare wires separated from the +24 V DC wire.

1. Verify that the 24 V DC power supply is unplugged and not receiving power.
2. Attach the +24 V DC connector of the Power and I/O Breakout cable and Ground wires to the corresponding terminals on the power supply. For more information, see [Specifications on page 34](#).

 **CAUTION:** Never connect voltages other than 24 V DC. Always observe the polarity shown.

3. Attach the M8 connector of the Power and I/O Breakout Cable to the 24 V DC connector of the vision system.
4. Restore power to the 24 V DC power supply and turn it on if necessary.

Using Your In-Sight Vision System

This section provides information on the installation of the In-Sight Vision Suite, troubleshooting connection issues, tuning, image filtering, as well as vision system training and package detection.

Installing In-Sight Vision Suite

Follow the steps below to install and connect your vision system to the In-Sight Vision Suite.

1. Download the latest version of In-Sight from support.cognex.com/ and follow the on-screen steps.
2. Connect the 8900 series vision system to your PC.
3. Launch In-Sight Vision Suite and click **Refresh**.
4. Select a vision system from the list and click **Connect**.

Trigger Types

The In-Sight 8900 vision systems support the following trigger modes:

- **Single** (external trigger): Acquires a single image and runs the current job on the acquired image. The vision system relies on an external trigger source.
- **Self**: At a time interval you configure, the vision system acquires an image and runs the job continuously.

External Triggers

If you are using external triggering, you can use any of the following methods to trigger your vision system.

- Send a pulse on the I/O cable.
 - Trigger +
 - Trigger -
- Send a trigger command over Native Mode.
- Press **F5** on the keyboard while the In-Sight Vision Suite has the input focus.
- Click the **Trigger** button in the In-Sight Vision Suite.

Industrial Protocols

The vision system supports the following industrial protocols:

- EtherNet/IP™, EDS and PLC
- PROFINET (Class B)
- SLMP Protocol
- TCP/IP
- OPC/UA
- SFTP

For more information, see **Industrial Communications** in the *In-Sight Spreadsheet Help* documentation.

Specifications

The following sections list general specifications for the vision system.

In-Sight 8900 Series Vision System

Specification	Model
Memory	4 GB
Lens Type	C-Mount or Cognex High Speed Liquid Lens
Discrete Inputs	One opto-isolated, general purpose input
Discrete Outputs	Two opto-isolated, high speed outputs
Status LEDs	Network LED and two configurable LEDs
High Speed Liquid Lens Lifespan	1800 M focus cycles
Job/Program Memory	7.5 GB
Image Processing Memory	512 MB SDRAM
Network Communication	One Ethernet port, 10/100/1000 BaseT with auto MDIX IEEE 802.3 TCP/IP Protocol Supports DHCP, static, and link-local address configuration.
Communication Protocols	TCP/IP, PROFINET, EtherNet/IP, SLMP, ModbusTCP, (S)FTP
Power Consumption	24 V DC \pm 10%, 2.0 A maximum Class III Power over Ethernet (PoE) USB-C power 1.5 A minimum
Material	Die-cast aluminum and zinc housing
Finish	Painted
Mounting	Four M3 threaded mounting holes. Pattern: 44.25 mm (1.74 in) length, 22 mm (0.87 in) width side 1, 18 mm (0.71 in) width side 2.
Weight	In-Sight 8900 with no accessories attached: 205 g (7.2 oz). With High Speed Liquid Lens (25 mm): 320 g (11.3 oz).
Ambient Operating Temperature	0° C to 40° C (32° F to 104° F)
Storage Temperature	-20° C to 80° C (-4° F to 176° F)
Humidity	<95% non-condensing
Protection	IP40 with all cables properly attached and lens properly attached
Shock (Shipping and Storage)	IEC 60068-2-27: 18 shocks (3 shocks in each polarity in each (X, Y, Z) axis) 80 Gs (800 m/s ² at 11 ms, half-sinusoidal) with cables or cable plugs and a 150 gram or lighter lens attached.

Specification	Model
Vibration (Shipping and Storage)	IEC 60068-2-6: vibration test in each of the three main axis for 2 hours at 10 Gs (10 to 500 Hz at 100 m/s ² / 15 mm) with cables or cable plugs and a 150 gram or lighter lens attached.
Regulations and Conformity	CE, FCC, KCC, EU RoHS, China RoHS

In-Sight 8900 Series Vision System Image Sensor

Specification	In-Sight 8900M	In-Sight 8900C	In-Sight 8902M	In-Sight 8902C	In-Sight 8905M	In-Sight 8905C	In-Sight 8912M	In-Sight 8912C
Bit Depth	8-bit monochrome	24-bit color	8-bit monochrome	24-bit color	8-bit monochrome	24-bit color	8-bit monochrome	24-bit color
Frames Per Second (Maximum, Full Resolution)	142	100	86	49	47	29	21	10
Image Sensor Type	CMOS, global shutter							
Image Sensor Properties	2.7 mm diagonal, 2.74 x 2.74 μm square pixels	6.2 mm diagonal, 2.74 x 2.74 μm square pixels	8.8 mm diagonal, 2.74 x 2.74 μm square pixels	14 mm diagonal, 2.74 x 2.74 μm square pixels				
Maximum Image Resolution (pixels)	800 x 600	1920 x 1200	2448 x 2048	4096 x 3000				
Electronic Shutter Speed	29.1 us to 200,000 us							

Spectral Response Curves

The following diagrams represent the response of the vision system to different wavelengths of light.

In-Sight 8900M, 8902M, and 8905M:

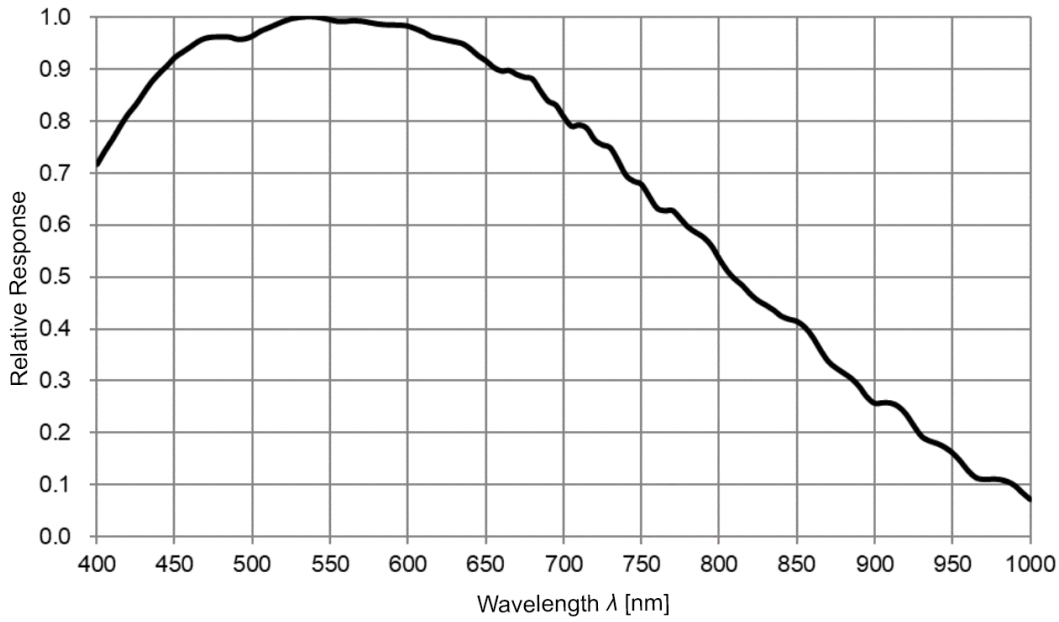

In-Sight 8900C, 8902C, and 8905C:

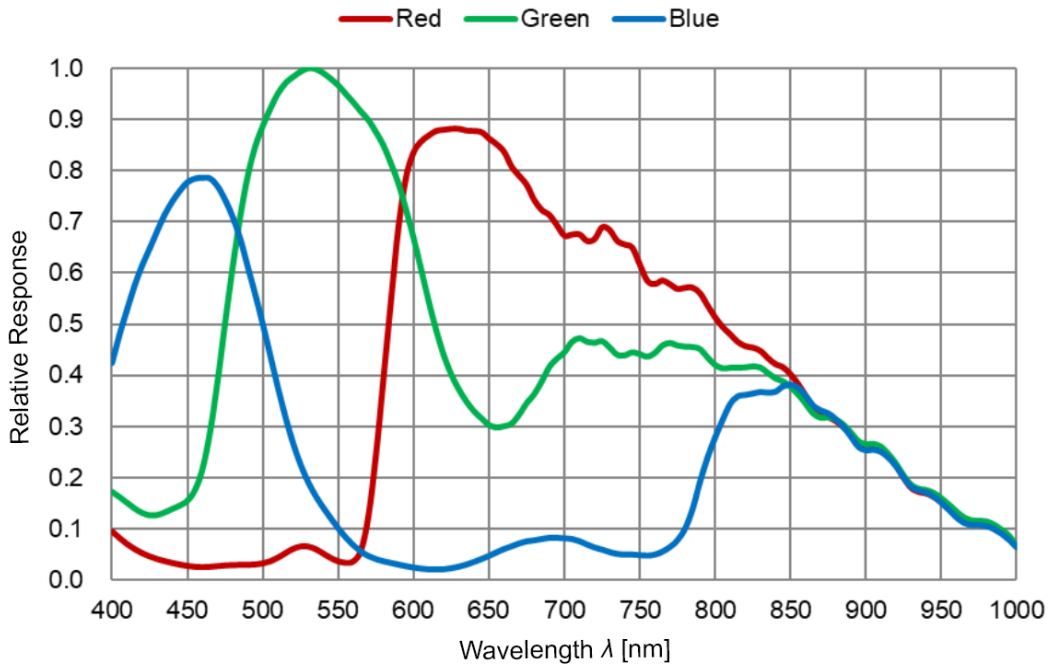

In-Sight 8912M:

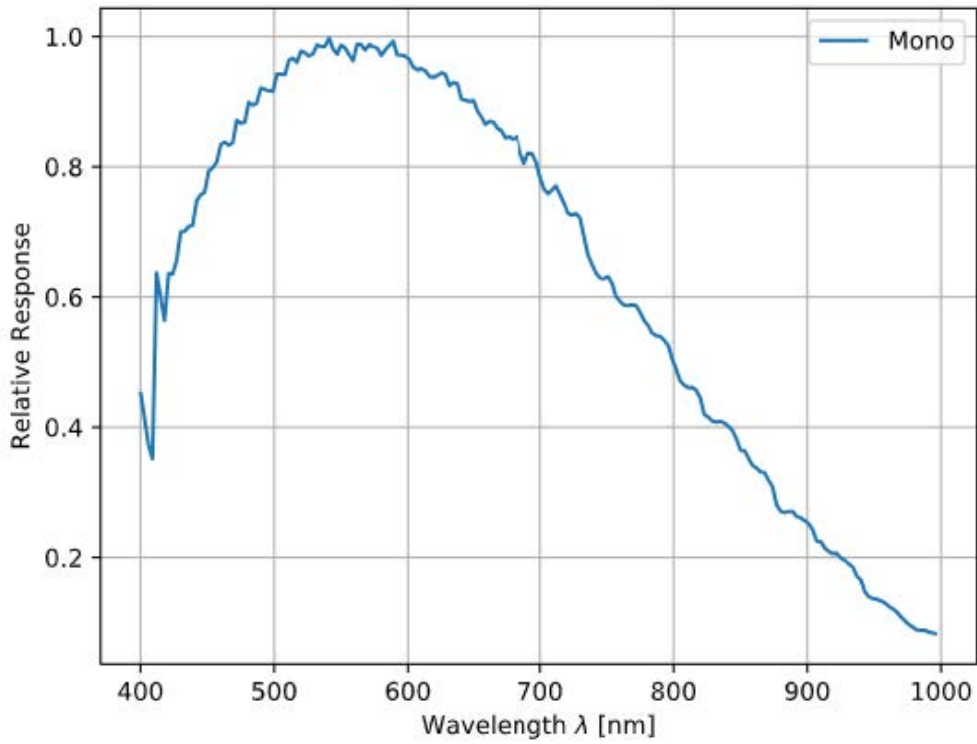

In-Sight 8912C:

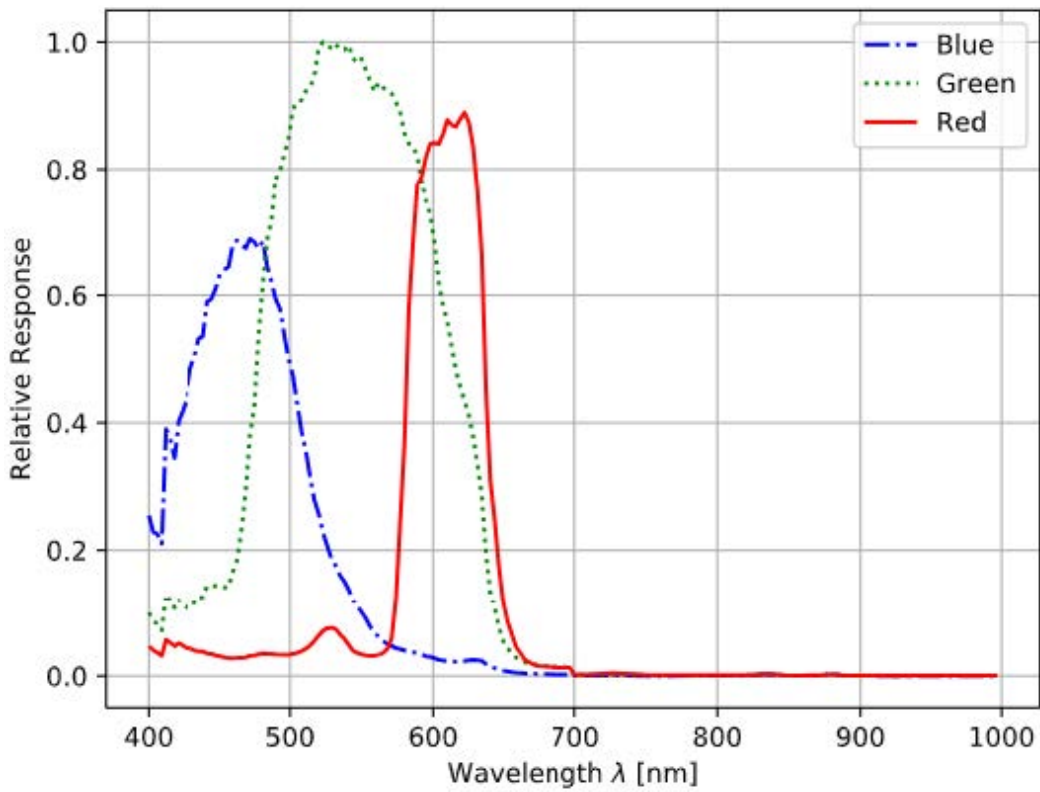

Acquisition Trigger Input

The vision system features one acquisition trigger input, which is optically isolated. You can configure the acquisition trigger input to trigger from an NPN (current sinking) or PNP (current sourcing) device.

Specification	Description
Voltage	ON: 15 to 28 V DC (24 DC nominal) OFF: 0 to 5 V DC (11.5 V DC nominal threshold)
Current (Typical)	ON: 2.6 mA to 4.9 mA from 15 to 28 V Input OFF: <830 μ A for < 5 V DC Resistance: ~6 kOhms
Delay	24 μ s maximum latency between leading edge of trigger and start of aquisition. Input pulse should be a minimum of 1 ms wide.

- To trigger from an NPN type photoelectric sensor or PLC output, connect COMMON IN to +24 VDC and connect IN 0 to the output of the photoelectric sensor. When the output turns ON, it pulls TRIGGER down to 0 VDC, turning the opto-coupler ON.
- To trigger from a PNP photoelectric sensor or PLC output, connect IN 0 to the output of the photoelectric sensor and connect COMMON IN to 0 VDC. When the output turns ON, it pulls TRIGGER up to +24 VDC, turning the opto-coupler ON.

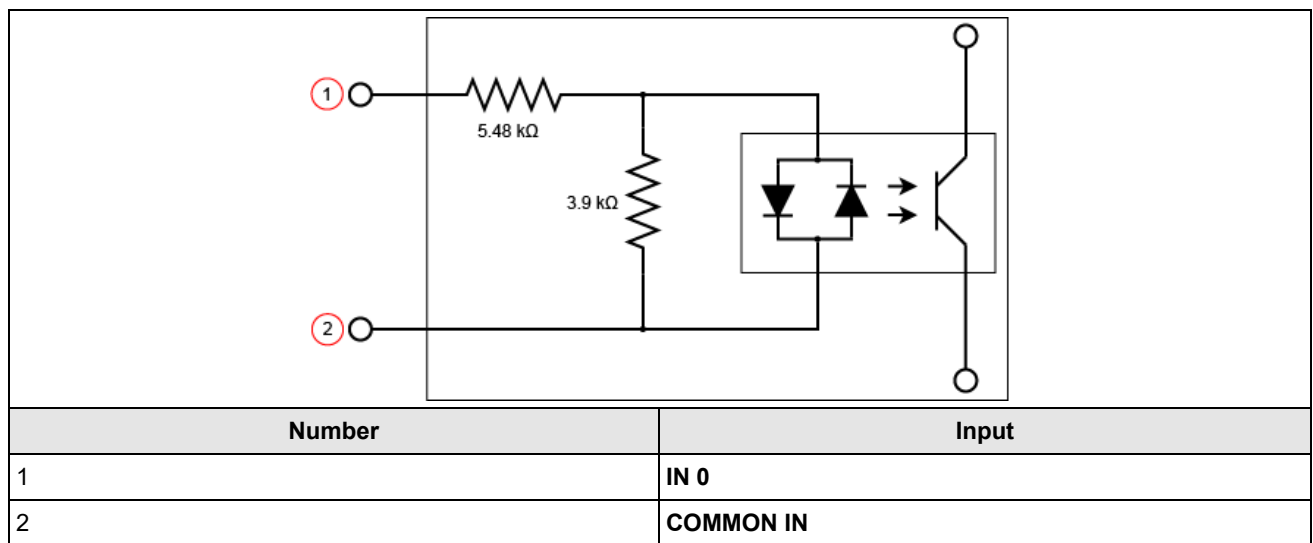

High-Speed Outputs

Specification	Description
Voltage	V_{MAX} : 26 VDC maximum through external load V_{OL} : $\leq \pm 3$ V @ 50 mA
Current	I_{MAX} : 50 mA maximum sink or source current Each line is protected against over-current, short circuits and transients from switching inductive loads. High current inductive loads require an external protection diode.

For NPN lines, the external load should be connected between the output and the positive supply voltage (< 26 VDC). The output pulls down to less than 3 VDC when ON, which causes current to flow through the load. When the output is OFF, no current flows through the load.

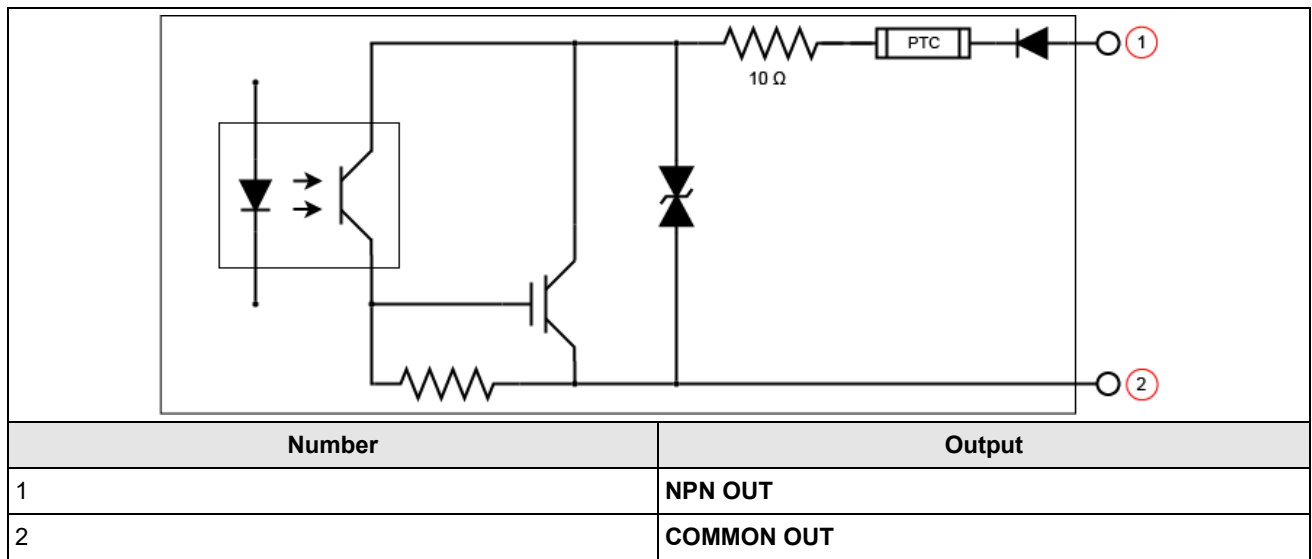

For PNP lines, the external load should be connected between the output and the negative supply voltage (0 VDC). When connected to a 24 VDC power supply, the output pulls up greater than 21 VDC when ON, and current flows through the load. When the output is OFF, no current flows through the load.

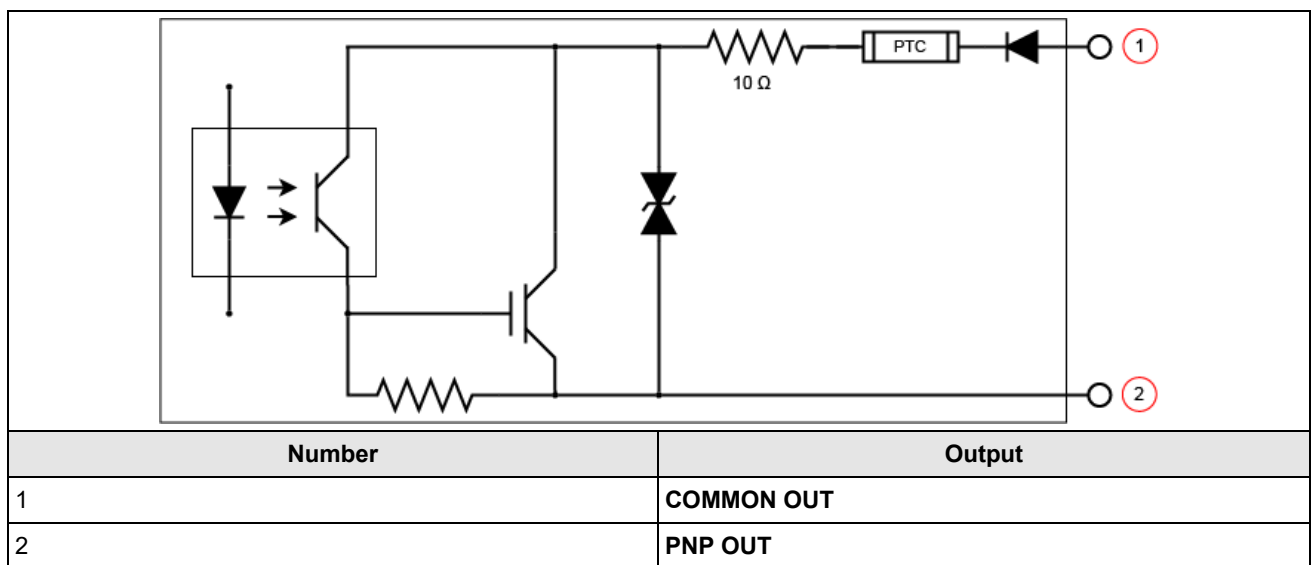

Ethernet Cable

The Ethernet cable provides Ethernet connectivity to the vision system. The Ethernet cable is used to connect the vision system to other network devices.

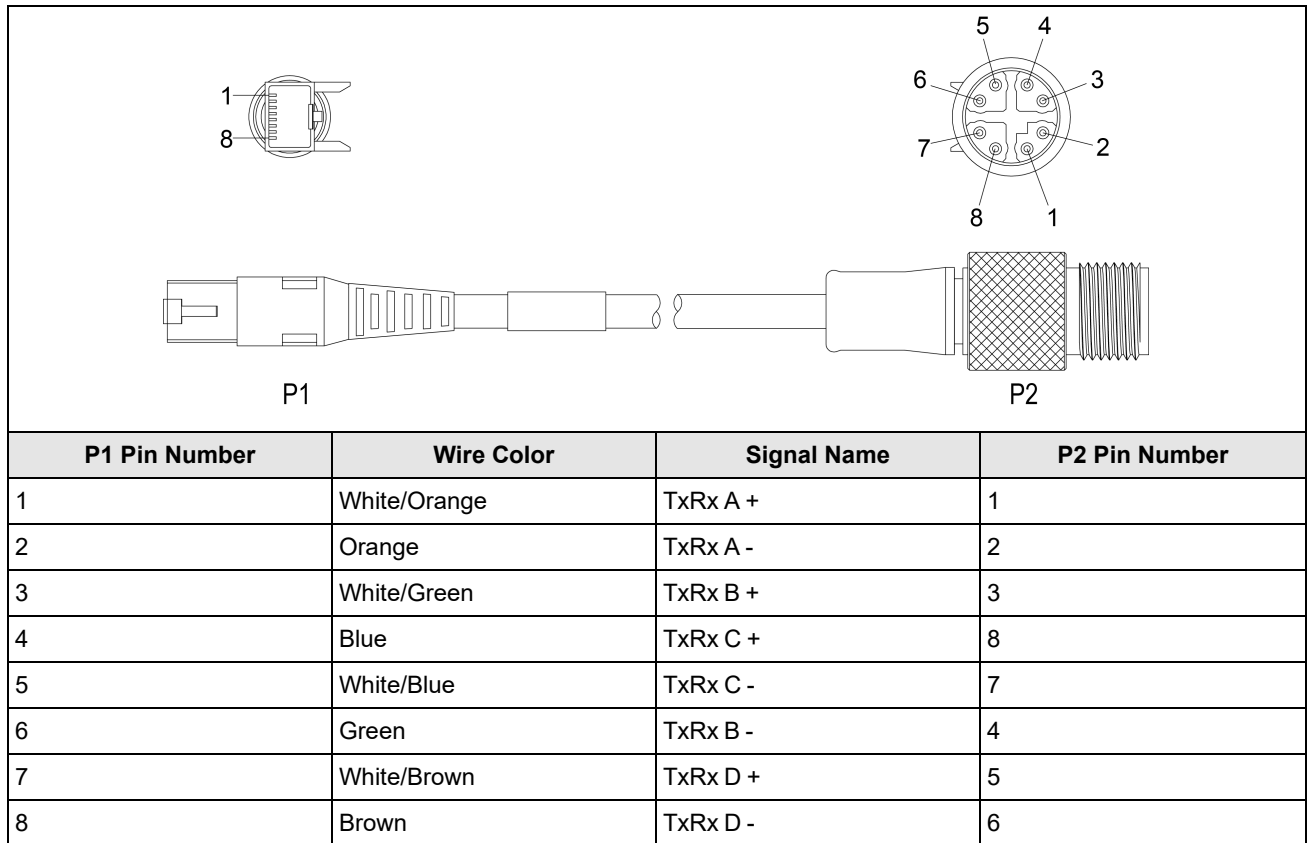

CAUTION: The Ethernet cable shield must be grounded at the far end. Whatever this cable is plugged into (typically a switch or router) should have a grounded Ethernet connector. A digital voltmeter should be used to validate the grounding. If the far end device is not grounded, a ground wire should be added in compliance with local electrical codes.

Note:

- Cables are sold separately.
- The wiring for this cable follows standard industrial Ethernet M12 specifications. It differs from the 568B standard.

Breakout Cable

The Breakout cable provides connections to an external power supply, the acquisition trigger input, general-purpose inputs, and high-speed outputs. The Breakout cable is not terminated.

The Breakout cable can be connected to devices, such as a trigger sensor or strobe light. The Breakout cable is not terminated.

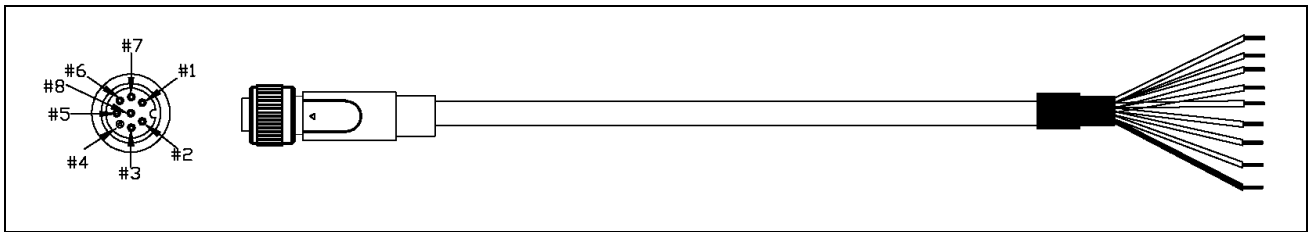

Pin#	Signal Names	Wire Color
1	HSOUT 1	Grey
2	HSOUT 0	Blue
3	GND	Black
4	+24VDC	Red
5	COMMON IN	White/Purple
6	Reserved	Purple
7	IN 0	Orange
8	COMMON OUT	Green

Note:

- Cables are sold separately.
- Perform wiring or adjustments to I/O devices when the vision system is not receiving power.
- You can cut exposed wires short or trim wire ends. You also can tie the wires back if you use a tie made of non-conductive material. Keep bare wires separated from the +24 V DC wire.
- When using the 15 meter Breakout cable, full 24 V DC voltage must be maintained at the input leads of the Breakout cable when the vision system is operating.

Cleaning and Maintenance

Clean the Housing

To clean the outside of the vision system housing, use a small amount of mild detergent cleaner or isopropyl alcohol on a cleaning cloth. Do not pour the cleaner on the vision system housing.

 **CAUTION:** Do not attempt to clean any In-Sight product with harsh or corrosive solvents, including lye, methyl ethyl ketone (MEK) or gasoline.

Clean the Vision System Image Sensor Window



To remove dust from the outside of the image sensor window, use a pressurized air duster. The air must be free of oil, moisture or other contaminants that could remain on the glass and possibly degrade the image. Do not touch the glass window. If oil or smudges remain, use a cotton bud and alcohol (ethyl, methyl, or isopropyl) to clean the window. Do not pour the alcohol on the window.

Clean the Vision System Lens Cover

To remove dust from the lens cover, use a pressurized air duster. The air must be free of oil, moisture or other contaminants that could remain on the lens cover. To clean the plastic window of the lens cover, use a small amount of isopropyl alcohol on a cleaning cloth. Do not scratch the plastic window. Do not pour the alcohol on the plastic window.

Regulations and Conformity

Note: For the most current CE and UKCA declaration and regulatory conformity information, see the Cognex support site: cognex.com/support.

Safety and Regulatory	
Manufacturer	Cognex Corporation One Vision Drive Natick, MA 01760 USA
	In-Sight 8900: Regulatory Model 50116 This is a class A product. In a domestic environment this product may cause radio interference in which case the user may be required to take immediate measures. This equipment complies with the essential requirements of the EU Directive 2014/30/EU. Declarations are available from your local representative.
EU RoHS	Compliant to the most recent applicable directive.
FCC	FCC Part 15, Class A This equipment has been tested and found to comply with the limits for a Class A digital device, pursuant to part 15 of the FCC Rules. These limits are designed to provide reasonable protection against harmful interference when the equipment is operated in a commercial environment. This equipment generates, uses, and can radiate radio frequency energy and, if not installed and used in accordance with the instruction manual, may cause harmful interference to radio communications. Operation of this equipment in a residential area is likely to cause harmful interference in which case the user will be required to correct the interference at his own expense.
Korea 	Regulatory Model 50116: R-R-CGX-50116 This device is certified for office use only and if used at home, there can be frequency interference problems.
UL, TÜV	Regulatory Model 50116
	NRTL OSHA Scheme for UL/CAN 61010-1.
	CB report available upon request. TÜV SÜD, IEC/EN 61010-1.
	In-Sight 8900: Regulatory Model 50116 This is a class A product. In a domestic environment this product may cause radio interference in which case the user may be required to take immediate measures. This equipment complies with the essential requirements of the Electromagnetic Compatibility Regulations 2016. Declarations are available from your local representative.

中国大陆RoHS (Information for China RoHS Compliance)

根据中国大陆《电子信息产品污染控制管理办法》(也称为中国大陆RoHS), 以下部份列出了本产品中可能包含的有毒有害物质或元素的名称和含量。



Hazardous Substances 有害物质						
Part Name 部件名称	Lead (Pb) 铅	Mercury (Hg) 汞	Cadmium (Cd) 镉	Hexavalent Chromium (Cr (VI)) 六价铬	Polybrominated biphenyls (PBB) 多溴联苯	Polybrominated diphenyl ethers (PBDE) 多溴二苯醚
Regulatory Model 50116	X	O	O	O	O	O

This table is prepared in accordance with the provisions of SJ/T 11364.

这个标签是根据SJ/T 11364 的规定准备的。

O: Indicates that said hazardous substance contained in all of the homogeneous materials for this part is below the limit requirement of GB / T26572 - 2011.

表示本部件所有均质材料中含有的有害物质低于GB / T26572 - 2011 的限量要求。

X: Indicates that said hazardous substance contained in at least one of the homogeneous materials used for this part is above the limit requirement of GB / T26572 - 2011.

表示用于本部件的至少一种均质材料中所含的危害物质超过GB / T26572 - 2011 的限制要求。

For European Community Users

Cognex complies with Directive 2012/19/EU OF THE EUROPEAN PARLIAMENT AND OF THE COUNCIL of 4 July 2012 on waste electrical and electronic equipment (WEEE).

This product has required the extraction and use of natural resources for its production. It may contain hazardous substances that could impact health and the environment, if not properly disposed.

In order to avoid the dissemination of those substances in our environment and to diminish the pressure on the natural resources, we encourage you to use the appropriate take-back systems for product disposal. Those systems will reuse or recycle most of the materials of the product you are disposing in a sound way.



The crossed out wheeled bin symbol informs you that the product should not be disposed of along with municipal waste and invites you to use the appropriate separate take-back systems for product disposal.

If you need more information on the collection, reuse, and recycling systems, please contact your local or regional waste administration.

You may also contact your supplier for more information on the environmental performance of this product.

