

DataMan[®] 503 Reference Manual



2022 January 07
Revision: 6.3.1.1

Legal Notices

The software described in this document is furnished under license, and may be used or copied only in accordance with the terms of such license and with the inclusion of the copyright notice shown on this page. Neither the software, this document, nor any copies thereof may be provided to, or otherwise made available to, anyone other than the licensee. Title to, and ownership of, this software remains with Cognex Corporation or its licensor. Cognex Corporation assumes no responsibility for the use or reliability of its software on equipment that is not supplied by Cognex Corporation. Cognex Corporation makes no warranties, either express or implied, regarding the described software, its merchantability, non-infringement or its fitness for any particular purpose.

The information in this document is subject to change without notice and should not be construed as a commitment by Cognex Corporation. Cognex Corporation is not responsible for any errors that may be present in either this document or the associated software.

Companies, names, and data used in examples herein are fictitious unless otherwise noted. No part of this document may be reproduced or transmitted in any form or by any means, electronic or mechanical, for any purpose, nor transferred to any other media or language without the written permission of Cognex Corporation.

Copyright © 2021. Cognex Corporation. All Rights Reserved.

Portions of the hardware and software provided by Cognex may be covered by one or more U.S. and foreign patents, as well as pending U.S. and foreign patents listed on the Cognex web site at: cognex.com/patents.

The following are registered trademarks of Cognex Corporation:

Cognex, 2DMAX, Advantage, AlignPlus, Assemblyplus, Check it with Checker, Checker, Cognex Vision for Industry, Cognex VSOC, CVL, DataMan, DisplayInspect, DVT, EasyBuilder, Hotbars, IDMax, In-Sight, Laser Killer, MVS-8000, OmniView, PatFind, PatFlex, PatInspect, PatMax, PatQuick, SensorView, SmartView, SmartAdvisor, SmartLearn, UltraLight, Vision Solutions, VisionPro, VisionView

The following are trademarks of Cognex Corporation:

The Cognex logo, 1DMax, 3D-Locate, 3DMax, BGAll, CheckPoint, Cognex VSoC, CVC-1000, FFD, iLearn, In-Sight (design insignia with cross-hairs), In-Sight 2000, InspectEdge, Inspection Designer, MVS, NotchMax, OCRMax, PatMax RedLine, ProofRead, SmartSync, ProfilePlus, SmartDisplay, SmartSystem, SMD4, VisiFlex, Xpand

Portions copyright © Microsoft Corporation. All rights reserved.

Portions copyright © MadCap Software, Inc. All rights reserved.

Other product and company trademarks identified herein are the trademarks of their respective owners.

Table of Contents

Legal Notices	2
Table of Contents	3
Symbols	5
Getting Started	6
About DataMan 503	6
DataMan 503 Accessories	7
DataMan 503 Systems	9
Setting Up Your DataMan	10
Reader Layout	10
Dimensions	12
DataMan 503 Specifications	12
DataMan 503 Imager Specifications	13
Installing a C-Mount Lens	14
Connecting External Illumination	15
Single Light	15
Multiple Lights	15
Synchronized Acquisition	18
Multi-port Connections	18
Using Your DataMan 503 Reader	22
Installing the DataMan Software	22
Troubleshooting an Ethernet Connection	22
Industrial Protocols	23
DataMan 503 Triggering	24
Multi-Reader Triggering	24
Training the Reader	25
Training Feedback	26
Incremental Training for Multiple Symbologies	26
Package Detection Support	26
Connections, Optics and Lighting	27
I/O Cable (CCBL-05-01)	27
RS-232 Cable (CCB-M8X4-xx)	27
External Light Control (CCB-M12x4MS)	28
High-Speed Output Lines	29
High-Speed Output Wiring	29
Ethernet M12 to RJ45 Cable (CCB-84901-y00x-xx)	31
Acquisition Triggering	31
Cleaning and Maintenance	32
Cleaning the Reader Housing	32
Cleaning the Reader Lens Cover	32
Compliance Information, Warnings and Notices	33
Warnings and Notices	33
Compliance Statements	34

For European Community Users35

Symbols

The following symbols indicate safety precautions and supplemental information:

 **WARNING:** This symbol indicates a hazard that could cause death, serious personal injury or electrical shock.

 **CAUTION:** This symbol indicates a hazard that could result in property damage.

 **Note:** This symbol indicates additional information about a subject.

 **Tip:** This symbol indicates suggestions and shortcuts that might not otherwise be apparent.

Getting Started

This section provides general information about the DataMan 503 reader as well as about the DataMan 503 accessories and systems.

About DataMan 503



The DataMan 503 is a high-performance, fixed-mount ID reader that offers the following advanced features:

- Ultra-sensitive custom image sensor that allows short exposures to freeze part motion
- High-performance processing unit that provides extremely short cycle times
- Automatic regulation of exposure time and gain to provide maximum performance
- Electronically controlled solid-state variable focus system
- Dynamically configurable network-based multiple-reader decoding (“Multi-Reader Sync”)

The DataMan 503 provides advanced Ethernet connectivity, support for serial and discrete I/O, as well as advanced options for lighting and optics.

The DataMan 503 is packaged in a rugged, IP65-rated housing, and it provides numerous ease-of-use features, including one-button code training.

This document provides basic information about how to configure and use DataMan 503 readers. Additional information is available through the Windows **Start** menu or the DataMan Setup Tool **Help** menu after you install the DataMan software on your PC:

- The **DataMan Communications and Programming Guide** shows you how to integrate your DataMan reader into your particular automation and factory environment.
Cognex->DataMan Software v x.x.x->Documentation->Communications->DataMan Communications and Programming Guide
- The **DataMan Industrial Protocols Manual** provides information on how to integrate DataMan readers into your particular environment using industrial protocols.
Cognex->DataMan Software v x.x.x->Documentation->Communications->DataMan Industrial Protocols Manual
- The **DataMan Reader Configuration Codes** document provides printable 2-D codes that you can use to configure the DataMan reader.
Cognex->DataMan Software v x.x.x->Documentation->English->Reader Configuration Codes
- The **DM503 Quick Reference Guide** provides essential information about the DM503 readers.
Cognex->DataMan Software v x.x.x->Documentation->English->DM503 Series->DM503 Quick Reference Guide

- The **DataMan Fixed-Mount Readers Reference** is a complete online hardware reference for the DataMan fixed-mount ID readers.

Cognex->DataMan Software v x.x.x->Documentation->English->DM503 ->Fixed-Mount Reference Manual

- The **DataMan Questions and Answers** document provides context-sensitive information. You can view this help inside the DataMan Setup Tool or as a stand-alone help file.

Cognex->DataMan Software v x.x.x->Documentation->DM503->Questions and Answers

- The **DataMan Control Commands** lists DataMan Control Commands with all relevant information. You can view this help inside the Setup Tool or as a stand-alone help file.

Cognex->DataMan Software v x.x.x->Documentation->English->DataMan Control Commands

- The **Setup Tool Reference Manual** describes the user interface of the DataMan Setup Tool software.

Cognex->DataMan Software v x.x.x->Documentation->English->Setup Tool Reference Manual

- The **Release Notes** list detailed system requirements and additional information about this DataMan software release.

Cognex->DataMan Software v x.x.x->Documentation->DataMan v x.x.x Release Notes

DataMan 503 Accessories



C-MOUNT LENS OPTIONS

16 mm, 25 mm and 35 mm lens (LEC-CFFxx-F8) (xx specifies focal length)	
---	---

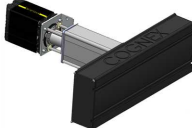
FIELD OF VIEW EXPANDERS

Xpand 15 (DMA-FOVE-15)	
Xpand 25 (DMA-FOVE-25)	

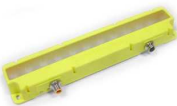





EXTERNAL LIGHT

SVL Light Bar (IVSL-YLW300-xxx)	
Bar light, blue (IVSL-LX520-470)	
Bar light, red (IVSL-LX520-650)	

HIGH POWER ILLUMINATIONS

DM503 high power illumination (DM503-HPIA-xxx)	
--	---

CABLES

Connection cable 24V, I/O, (CCBL-05-01)	
Ethernet M12 to RJ45 cable (CCB-84901-y00x-xx) (y straight/angled, x-xx specifies length)	
External light cable (CCB-M12x4MS-xxx) (xxx specifies length) Only compatible with CLRR / CLRB / CLRO / CLRS / CLRD illumination	
External light control cable for DataMan, 5 meters in length with flying leads (CCB-M12XFLY-05)	
Bar light cable (xxx specifies length: 300, 500, 1000, 2000 mm) (IVSL-5PM12-Jxxx) Compatible with IVSL lights, except IVSL-LX280	
I/O extension cable, 5m straight (CKR-200-CBL-EXT)	
Power cable for multiple bar lights (use in combination with IVSL-5PM12-5) (CCB-FOV25-MAL-012)	
RS-232 M8 to SUB-D cable (CCB-M8X4-xx)	
Synchronization Cable (DM503-SYNC-012 - 1.2 meter, DM503-SYNC-05 - 5 meter)	

DataMan 503 Systems

	High-Speed PArt Moving Applications	Omnidirectional Code Reading	1DMax™ — Best- In-Class 1-D Reading	IDQuick™ — High-Speed 2-D Reading
DataMan 503QL (DMR-503QL-xx)	√	√	√	
DataMan 503X (DMR-503X-xx)	√	√	√	√

Setting Up Your DataMan

This section provides information on the physical appearance of the DataMan 503 reader. It also details the steps of installing the lenses and filters of the reader, and gives information on the imager itself.

Reader Layout

The following images show the layout of the DataMan 503 series reader.

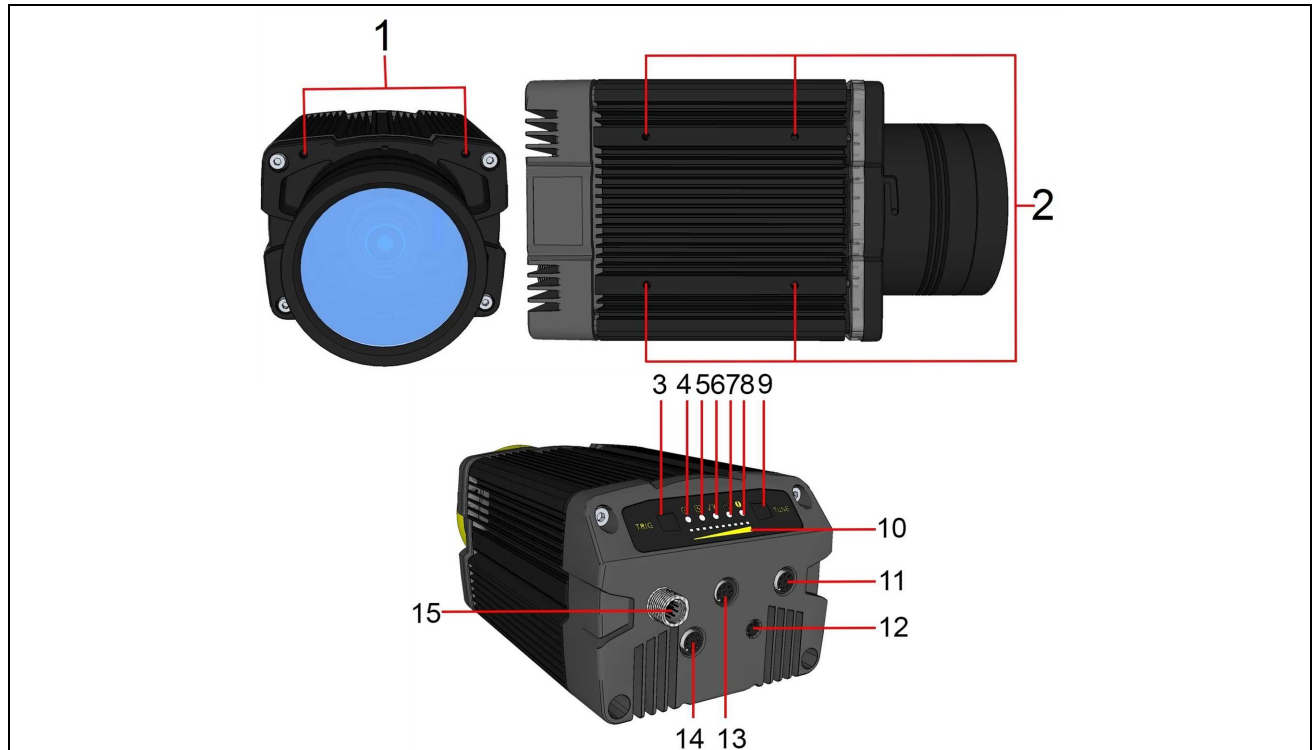

1	External illumination mounting point
2	Mounting holes (M3 x 5mm)
3	Trigger button
4	Power
5	Train status
6	Good/bad read
7	Network
8	Error
9	Tuning button
10	Peak meter
11	Synchronized Acquisition
12	RS-232
13	External light control
14	Ethernet
15	Power I/O

Indicator LEDs

Type	Signal	Color	Meaning
Status	Power	GREEN	Power ON
	Train status	GREEN	Trained
		YELLOW	Untrained
Error	RED	Error - check device log	
Action	Good/bad read	GREEN	Good read
		RED	Bad read
	Communication	YELLOW	Link up
		<i>blink</i>	Activity
	Peak meter	-	Decode yield, train progress/quality

Dimensions

Observe the following DataMan 503 dimensions when installing your reader.

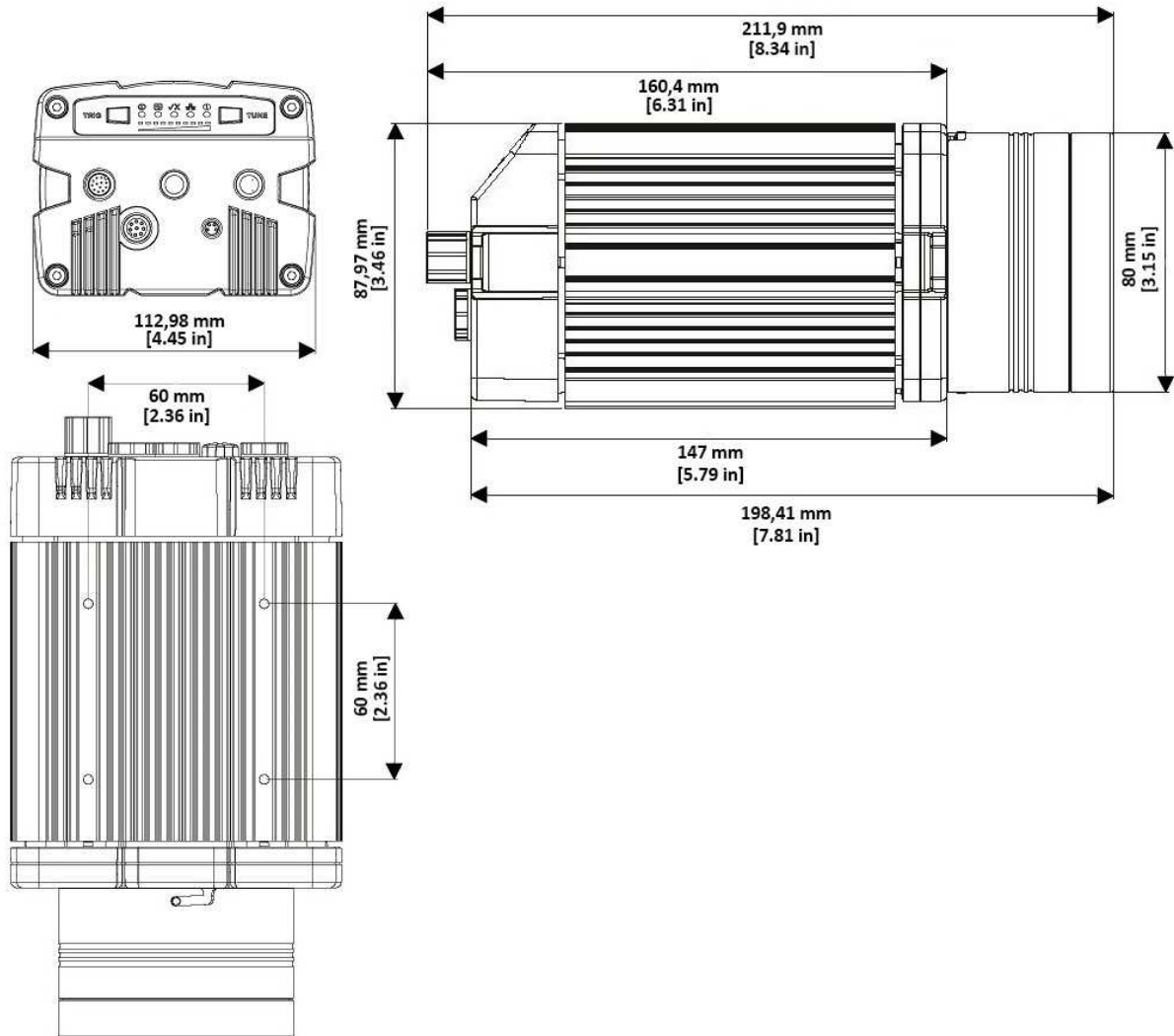

DataMan 503 Specifications

Weight	1602 g
Operating Temperature	0°C — 45°C (32°F — 113°F)
Storage Temperature	-10°C — 60°C (-14°F — 140°F)

Maximum Humidity	<95% (non-condensing)			
RS-232	RxD, TxD according to TIA/EIA-232-F			
Codes	1-D barcodes: Codabar, Code 39, Code 128, and Code 93, Interleaved 2 of 5, MSI, Pharma, GS1 DataBar, Postal, UPC/EAN/JAN 2-D barcodes: Data Matrix™ (IDMax: ECC 0, 50, 80, 100, 140, and 200; IDQuick: ECC200), QR Code and microQR Code, RSS/CS, PDF 417, MicroPDF 417			
Discrete I/O operating Limits	HS Output 0, 1	I_{MAX}	@ 24 VDC	50 mA
		R_{MAX}	@ 12 VDC	150 Ω
			@ 24 VDC	470 Ω
	Input 0 (Trigger)	V_{IL}	0 — ± 7 V	
	Input 1	I_{TYP}	@ 12 VDC	2.0 mA
		@ 24 VDC	4.2 mA	
Power Supply Requirements	24V +/- 10% Maximum current: 500 mA (at 25°C) Maximum power: 18W (external lights)			
Ethernet Speed	10/100/1000			
Duplex Mode	Full duplex or half duplex			

DataMan 503 Imager Specifications

Specification	DataMan 503 Imager
Image Sensor	2/3 inch CMOS
Image Sensor Properties	5.5 μ m square pixels
Image Resolution (Pixels)	2048 x 1088
Image Acquisition	Maximum 150 fps
Lens Type	C-mount lens

Installing a C-Mount Lens

DataMan 503 ships with no lens installed. You must install a standard C-mount lens before using your reader.

For reading distances and field of view charts, see the *DataMan Fixed-Mount Reference*, available through the Windows **Start** menu or the DataMan Setup Tool **Help** menu.

1. First, remove the front cover, if attached, and lens cover.



Note: Remove the protective cover from the lens mount.

CAUTION: Do not leave the DataMan sensor exposed to the environment!

2. Insert and thread lens into the reader.

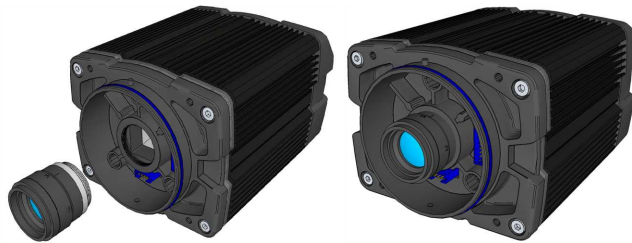

3. Align the peg on the reader and the slot on the cover, and re-attach it.



4. Lock the cover in place.



Connecting External Illumination

You can connect the following external lights to the external light control port of the DataMan 503 reader:

- Bar light (IVSL-YLW2X-xxx, IVSL-LX520-xxx)
- LX280-series light (IVSL-LX280-xxx)

Single Light

External light IVSL-YLW2X-xxx or IVSL-LX520-xxx connected to a DataMan 503:



External light IVSL-LX280-xxx connected to a DataMan 503:



Multiple Lights

Follow these steps to connect two or more bar lights (IVSL-YLW2X or IVSL-LX520-xxx):

1. Connect the lights with cable IVSL-5PM12-Jxxx.
2. Connect the light to the DataMan 503 with cable CCB-FOV25-MAL-012.
3. Cut and isolate brown wire (24 VDC) and blue wire (GND) from cable IVSL-5PM12-5 connected to the other light.

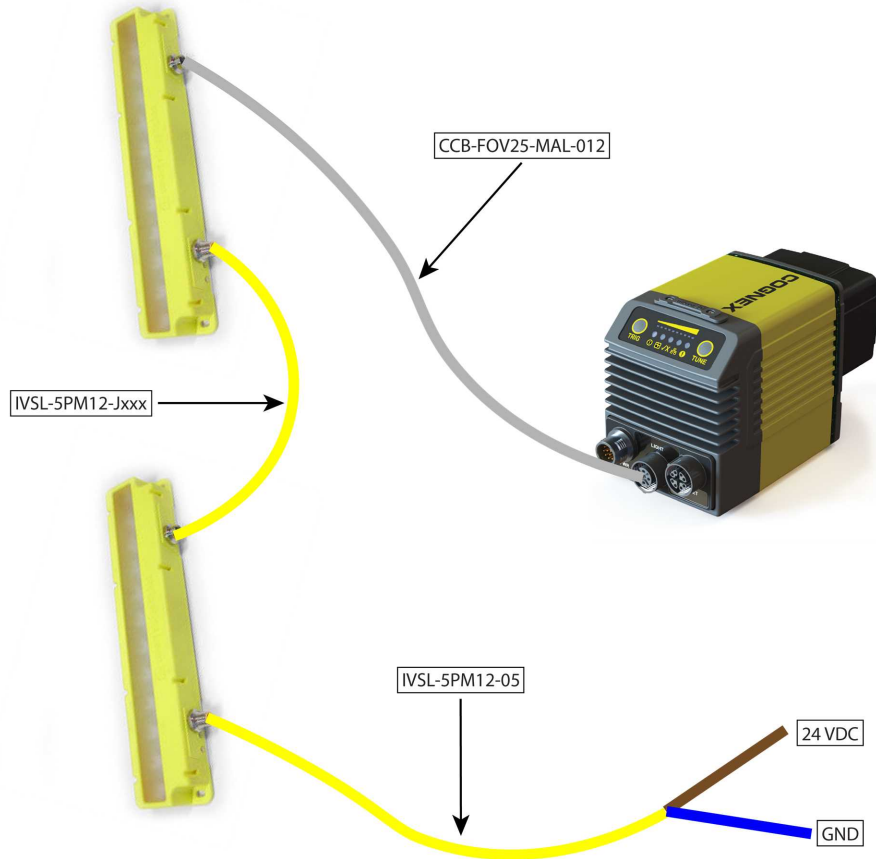

Follow these steps to connect two or more bar lights (IVSL-LX280-xxx):

1. Create a panel where all cables come together.
2. Connect the lights to the panel with cable IVSL-FSK-J5000.
3. Connect the DataMan 503 with cable CCB-M12XFLY-05.

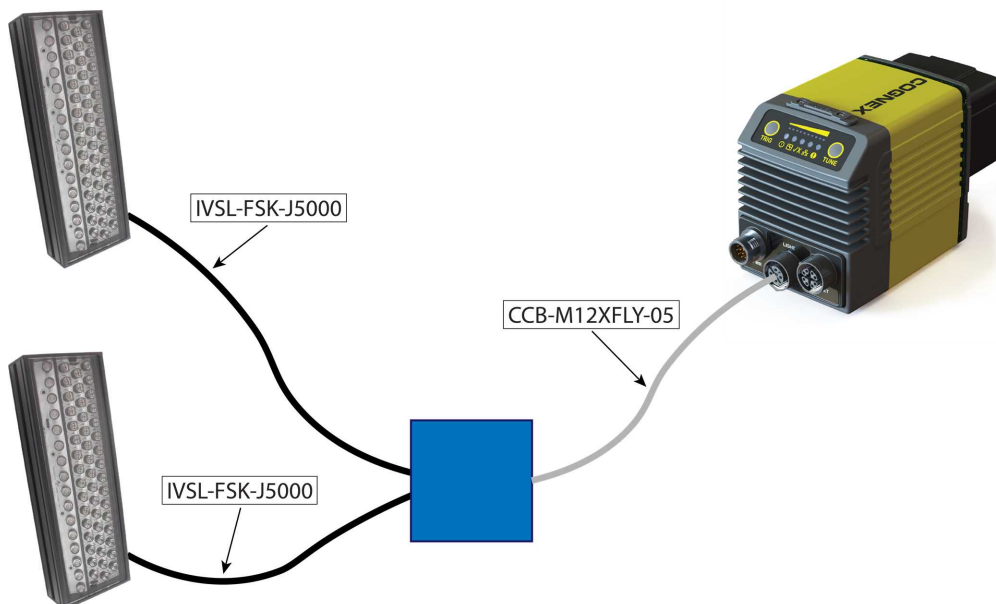

Inside the panel you need to:

1. Cut and isolate brown (24V) wire from CCB-M12XFLY-05.
2. Cut M12 connector from IVSL-FSK-J5000.
3. Strip open end from IVSL-FSK-J5000.

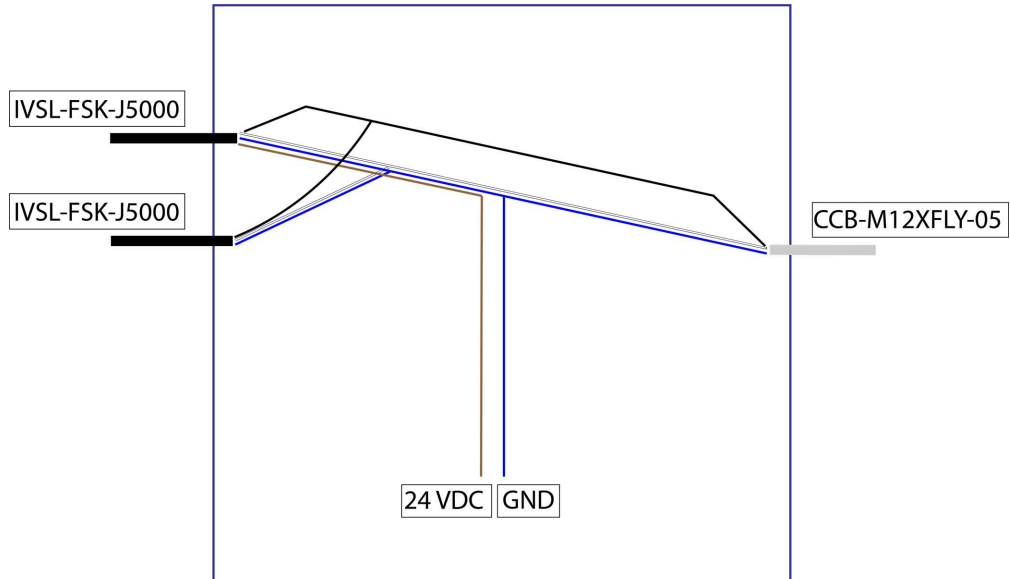

4. Connect all black wires together.
5. Connect all white wires together.
6. Connect all blue wires together.
7. Connect brown wires from IVSL-FSK-J5000 together
 - Cut off brown wire from CCB-M12XFLY-05
8. Connect blue wires to GND.
9. Connect brown wires to 24 VDC.

Note: For more details on the External Light Control, see [External Light Control \(CCB-M12x4MS\) on page 28](#).

Synchronized Acquisition

In **Single**, **Burst**, **Continuous**, and **Self** trigger modes, it is possible to synchronize image acquisition on multiple devices using the synchronization interface. Synchronization allows using one shared strobed illumination to expose all sensors simultaneously.

Note: This and other imager settings will not get synchronized by this mechanism. For example, you must configure exposure and gain on each reader individually.

This feature only synchronizes the actual image acquisition, triggering happens through the existing Multi-Reader Sync mechanism. In the DataMan Setup Tool's **Multi-Reader Sync** pane, enable **Synchronized Exposure**. You can synchronize up to 16 readers, with optionally triggering them in a defined sequence to avoid opposing readers from blinding each other. Set the **Acquisition Delay (μs)** (relative to the received signal through the synchronization interface) on each reader individually to optionally define an exposure sequence in case the illumination of some readers affect other readers.

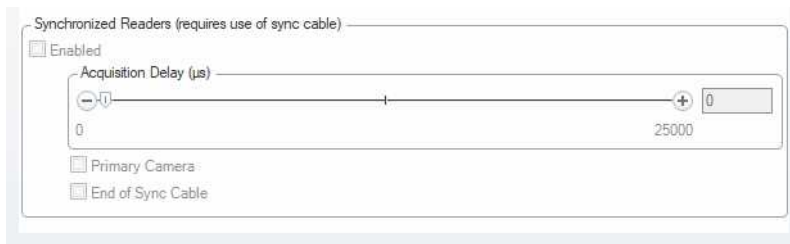

You must also set which two readers on the ends of the synchronization interface bus are bus terminators by checking the **End of Sync Cable** checkbox for the currently connected devices at the end of a sync cable.

Multi-port Connections

You can connect multiple DataMan 503 readers to a single PC (or other device equipped with a serial port) using a multi-port connection.

A multi-port connection creates a daisy-chain of readers. Each reader receives serial data from the previous reader and transmits it to the next reader. When a reader transmits data, it is passed through each of the readers in the chain between it and the PC.

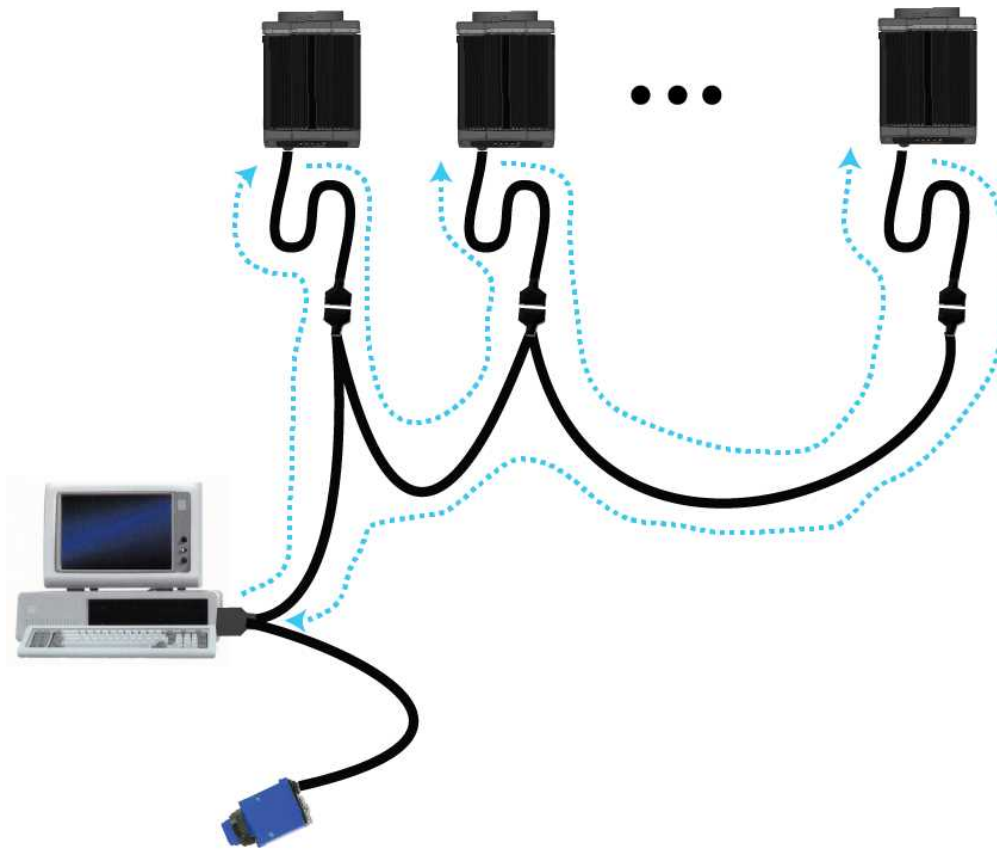

You must construct your own cable that meets the requirements of your system configuration.

The cable must provide a DB-15 connector for each DataMan 503 and a DB-9 connector for the PC serial port. Each DB-15 connector must provide Tx Data, Rx Data, Trigger (Input 0), ground, and DC power. The Tx Data and Rx Data pins on adjacent connectors must be connected to provide the multi-port connection.

The following diagram shows how to create a multi-port cable for a 3-reader system. In the example, all the readers share a common trigger. It is also possible to wire individual triggers for each reader.

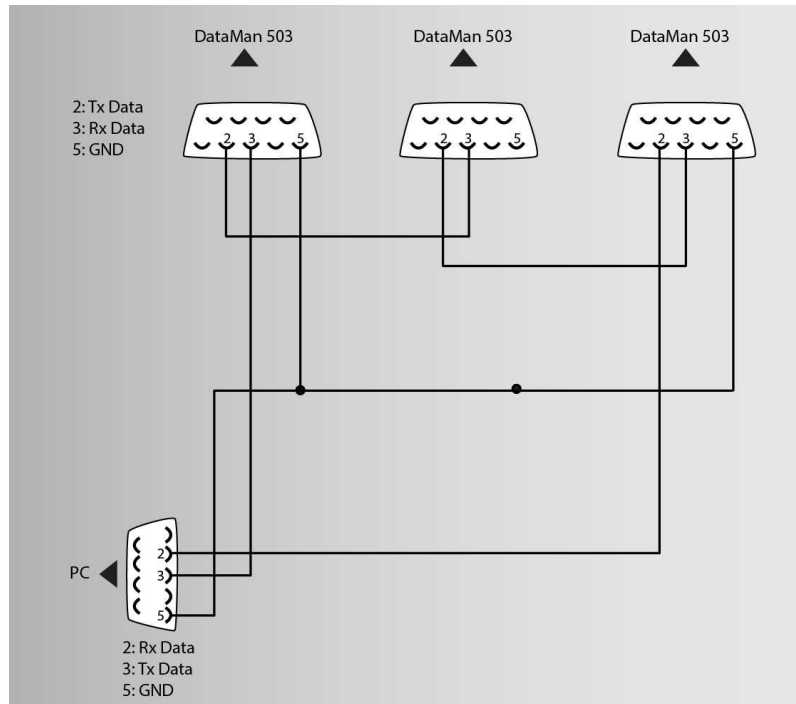

You must connect each DataMan 503 to DataMan Setup Tool using a USB connection and set the DataMan for multi-port operation. To configure a DataMan 503 for multi-port operation, click on the **Enable Multi-Port (RS-232 Sharing)** check box in **Communication Settings**.

There is no guaranteed delivery order when multiple readers transmit data using a multi-port connection; read results may arrive at the PC in any order. You can configure each DataMan 503 reader in a multi-port connection to add identifying data to each read result. Your PC application can then determine which reader produced a specific read result.

To do this, check the **Standard Formatting Enabled** box (for each symbology that you are using) in **Data Formatting**, and enter text in the **Leading Text** field. (You can also add trailing text by entering text in the **Trailing Text** field.)

You can obtain the best results when using multi-port connections by keeping the following usage guidelines in mind as you design your system:

- The maximum cable length between any two DataMan 503 readers or between the PC and any DataMan reader should be no greater than 15 meters.
- There is no fixed limit to the number of DataMan 503 readers that you can connect to a single PC. Each reader introduces a delay of about 100 ms when it retransmits received serial data. If you have 5 readers, this means that there will be a 400 ms delay between the time the first reader in the chain transmits data and the PC receives it.
- Each DataMan 503 reader must receive a hardware trigger signal on its Input 0 line. You can wire the input ports to a common trigger signal or you can provide individual triggers for each reader.
- Each DataMan 503 reader must be individually configured for multi-port operation, and you must perform this configuration using a USB connection.
- If *any* reader in the multi-port chain loses power or becomes disconnected, then no data from any other reader will be transmitted.

- If a DataMan 503 is transmitting its own read result, it will buffer any data received from another reader until it has finished its own data transmission. If a DataMan 503 is transmitting another reader's data, it will buffer its own data if it receives a trigger signal while it is processing the other reader's data.
- If you use a single power supply for multiple readers, make sure that the power supply can provide enough power for all of the readers.

Using Your DataMan 503 Reader

This section provides information on the installation process of the DataMan Setup Tool, troubleshooting Ethernet connection issues, tuning, image filtering, as well as reader training and package detection.

Installing the DataMan Software

Before installing the DataMan Setup Tool, perform the following steps:

1. Connect the I/O+24V cable to your reader.
2. For a network connection, connect your reader, through an Ethernet cable, to your network.
3. Connect the cable to a 24V power supply.

 **WARNING:** Do not use power supply with maximum current above 40A.

Perform the following steps to install DataMan Setup Tool:

1. Check the **DataMan Release Notes** for a full list of system requirements.
2. Download the DataMan Setup Tool from <http://www.cognex.com/support/dataman> and follow the on-screen steps.
3. Connect the DataMan 503 to your PC.
4. Choose **Start->Programs->Cognex->DataMan Software vx.x.x->Setup Tool** to launch the DataMan Setup Tool. Detected readers will appear under **COM ports**.
5. Click **Refresh** to update the list of connected devices.
6. Select a COM port that lists DataMan 503 and click **Connect**.

Troubleshooting an Ethernet Connection

Based on your network configuration, the DataMan Setup Tool may not be able to communicate with the reader and it will not appear in the list of **Network devices**.

1. First, check your Ethernet connection with the reader and click **Refresh** in the DataMan Setup Tool.
2. Next, scan the **Enable DHCP** code in the *Reader Configuration Codes* document available from the **Start** menu. This might allow the reader to acquire a suitable IP address from a DHCP server on your subnet.

If the reader still does not appear, you can use either the **Add Device** or **Force Network Settings** options in the DataManSetup Tool.

For more information, see the *DataMan Setup Tool Quick Reference Guide*.

You can also use the RS-232 connection to configure the reader with parameters that allow it to communicate over your Ethernet network.

Industrial Protocols

The DataMan 503 series readers support the following industrial protocols:

- EtherNet/IP™
- PROFINET
- SLMP Protocol
- Modbus TCP

Select industrial protocol samples and tools you want to use when you install the DataMan Software.

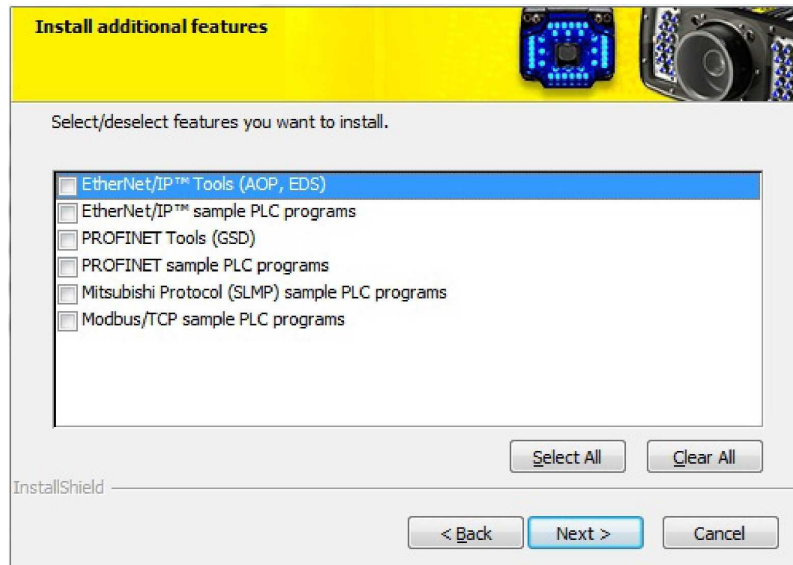

There are three ways to enable or disable Industrial Protocols. Using either method, a reboot is required for the changes to come into effect.

- Enable the protocols using the **Industrial Protocols** pane of the DataMan Setup Tool (under **Communication Settings**)
- Scan the appropriate **Reader Configuration codes** (see *Reader Configuration Codes* available through the Windows **Start** menu or the DataMan Setup Tool **Help** menu).
- Send the appropriate **DMCC** (see *DataMan Control Commands Documentation* available through the Windows **Start** menu or the DataMan Setup Tool **Help** menu).

For more information on using the industrial protocols, see the *DataMan Industrial Protocols Manual* available through the Windows **Start** menu or the DataMan Setup Tool **Help** menu.

DataMan 503 Triggering

DataMan 503 supports *self-triggered* operation. In self-trigger mode, at an interval you configure, the reader automatically detects and decodes codes in its field of view. The high-speed image acquisition and processing capabilities of the DataMan 503 allow it to detect *and decode* codes at up to 80 codes per second, multiple decodes per scan. If you set a higher re-read delay than the trigger interval, there is a code output only once until the code is out of the field of view for the duration of the re-read delay.

DataMan 503 also supports these additional trigger modes:

- **Single** (external trigger): Acquires a single image and attempts to decode any symbol it contains, or more than one symbol in cases where multicode is enabled. The reader relies on an external trigger source.
- **Presentation**: Scans, decodes and reports a single code in the field of view. The reader relies on an internal timing mechanism to acquire images.
- **Manual**: Begins acquiring images when you press the trigger button on the reader, and continues acquiring images until a symbol is found and decoded or you release the button.
- **Burst**: Performs multiple image acquisitions based on an external trigger and decodes any symbol appearing in a single image or within a sequence of images, or multiple symbols in a single image or within a sequence of images when multicode is enabled. You can control the number of images within each burst and the interval between image acquisitions.
- **Continuous**: Begins acquiring images based on a single external trigger and continues to acquire and decode images until a symbol is found and decoded, or until multiple images containing as many codes as specified in multicode mode are located, or until the trigger is released. You can configure your reader to acquire images based on the start and stop signal from separate digital IO pulses.

If you are using external triggering you can use any of the following methods to trigger DataMan 503:

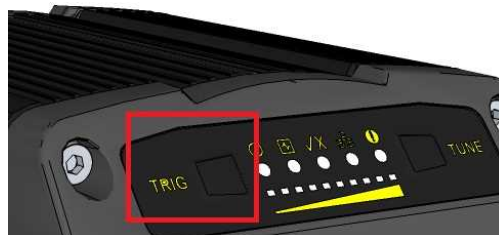

- Press the trigger button on the reader.
- Send a pulse on the I/O cable:
 - Trigger + (orange or red)
 - Trigger + (black)
- Send a trigger command over the RS-232 connection or Ethernet connection.
- Press <CTRL>-T on the keyboard.
- Click the **Trigger** button in the DataMan Setup Tool.

Multi-Reader Triggering

For trigger modes other than **Presentation**, the DataMan 503 supports *multi-reader triggering*, also known as *Multi-Reader Sync* configuration. In this configuration, you configure multiple DataMan 503 readers as a group. Whenever any reader in the group is triggered, all the readers are triggered and the results from all the readers are assembled and transmitted by a single reader that you designate as the Primary Reader.

Multi-reader triggering is used to support extended field of view reading and reading codes from multiple product surfaces:

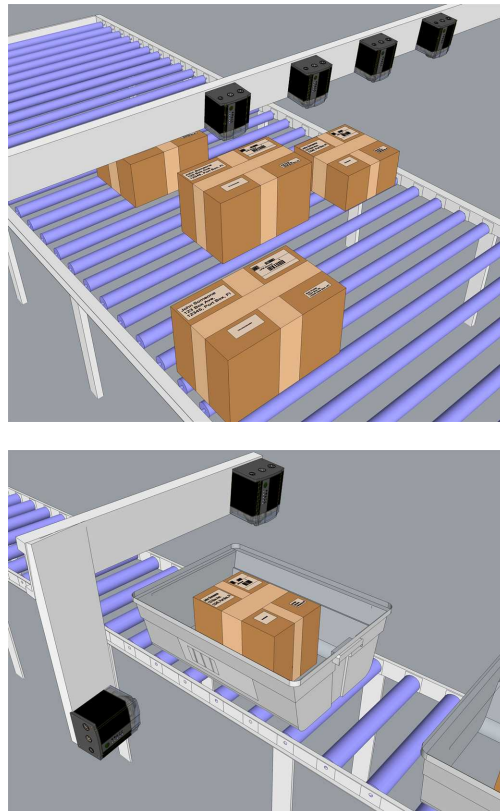

To configure multi-reader triggering, click **Toggle Group Triggering** in the group editor page of the DataMan Setup Tool. For more information, see the *DataMan Fixed-Mount Readers Reference* and the *DataMan Setup Tool Quick Reference Guide*.

Training the Reader

Training your reader with the expected symbology can decrease the time required to decode successive symbols. To train your reader, first switch to Single mode, then place a code in front of the reader and do one of the following:

- Press and hold the trigger button for a minimum of 3 seconds.



- Click and hold the trigger button in the DataMan Setup Tool for a minimum of 3 seconds.



- Click **Train Code** in the **Results Display** pane.



You can now switch to **Burst**, **Continuous** or **Self** trigger modes if necessary.

Note: Only a single symbol of each symbology kind can be trained.

Training Feedback

The second LED from the left on the reader glows green to indicate that it is currently trained, or yellow to indicate that it is not trained.

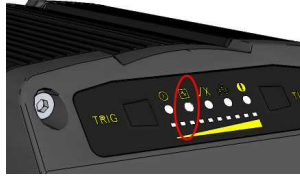

Connect the reader to the DataMan Setup Tool to untrain it and allow it to recognize other enabled symbologies.

Incremental Training for Multiple Symbologies

If you want to train the reader to recognize multiple symbologies, you can present a single image showing all the desired symbologies and perform the training procedure previously described.

If you cannot present a single image showing all the necessary symbologies, you can enable incremental training on the Training tab of the Symbology Settings pane:

With incremental training enabled, you can train the reader using multiple images showing the symbologies you expect to decode. The reader will train each new symbology while retaining the existing trained symbologies.

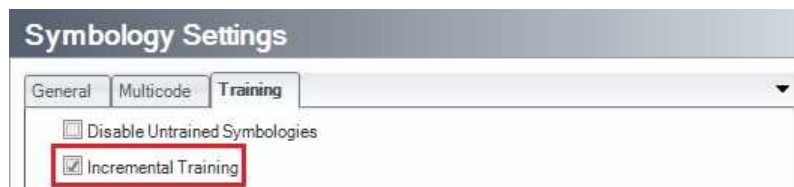

Package Detection Support

You can connect your package detection sensor to one of the digital inputs of your DataMan reader. When the reader receives a signal that a package is detected, images that the reader collected are not discarded at the end of the trigger. This way you can make sure that there was a package there, only the code was not readable. Looking at the No Read images will help you find out why there was no decode results

Package detection is only supported with **Continuous** trigger mode.

To make sure that the No Read images are collected, perform the following:

1. Connect your package detection device to one of the Inputs of your reader.
2. On the DataMan Setup Tool's **System Settings** pane's **Inputs** tab, check **Allow Buffered No-Read Images** on the input you connected your reader to.
3. On the DataMan Setup Tool's **Image Record and Playback** pane, change **What Images to Buffer** to *All*, or *No Read*.
 - In case of *All*, good reads are also saved together with No Reads.
 - In case of *No Read* the image is buffered if the reader fails to read.

For more information, see the *DataMan Fixed-Mount Readers Reference*, available through the Windows **Start** menu or the DataMan Setup Tool **Help** menu.

Connections, Optics and Lighting

This part contains descriptions about the external light control, I/O Cables, RS-232 cable, high-speed output lines, high-speed output wiring, Ethernet M12 to RJ45 cable, and acquisition triggering.

I/O Cable (CCBL-05-01)

The I/O breakout cable provides access to trigger and high-speed outputs. Unused wires can be clipped short or tied back using a tie made of non-conductive material.

This image on the left shows the plug on the device:

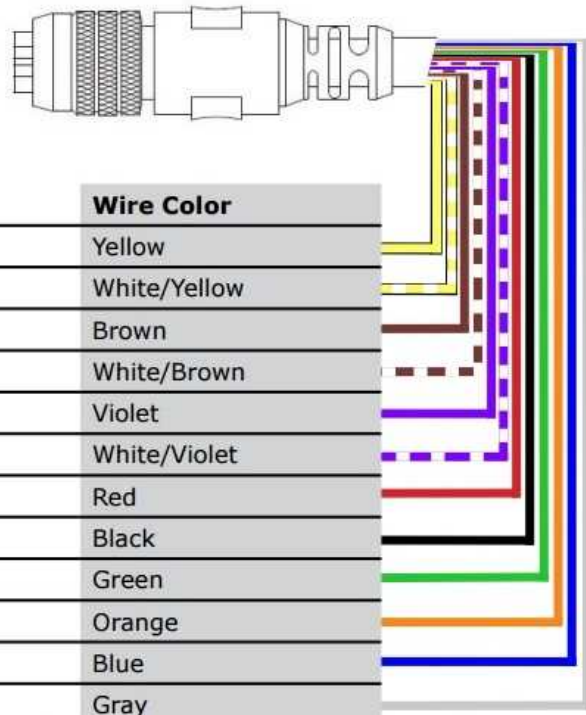

Pin #	Signal Name	Wire Color
1	Out 2	Yellow
2	In 3	White/Yellow
3	In 2	Brown
4	Out 3	White/Brown
5	In 1	Violet
6	Common In	White/Violet
7	+24 VDC	Red
8	GND	Black
9	Common Out	Green
10	In 0	Orange
11	Out 0	Blue
12	Out 1	Gray

RS-232 Cable (CCB-M8X4-xx)

The RS-232 cable provides an optional connection between the reader and your PC.

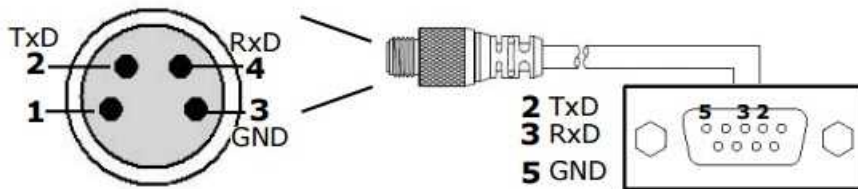

External Light Control (CCB-M12x4MS)

A 4-pin cable is provided for the external light control.

Current load: average: 500mA, peak: 1A (max. 100 μ s)

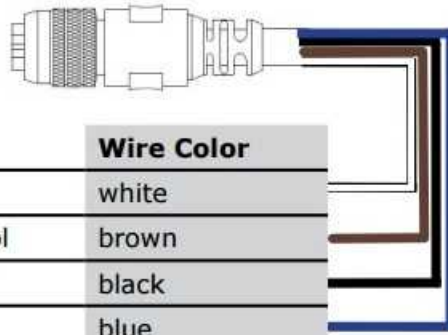
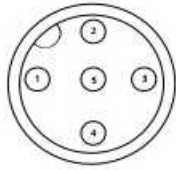

Pin #	Signal Name	Wire Color
1	+24 VDC	white
2	Brightness Control	brown
3	GND	black
4	Strobe	blue
5	Chassis	not connected

Note: This socket does not work if the external light is connected to one of the outputs on the I/O cable.

High-Speed Output Lines

The high-speed outputs can be used as either NPN (pull-down) or PNP (pull-up) lines. For NPN lines, the external load should be connected between the output and the positive supply voltage (<28V). The outputs pull down to less than 3V when ON, which causes current to flow through the load. When the outputs are OFF, no current flows through the load.

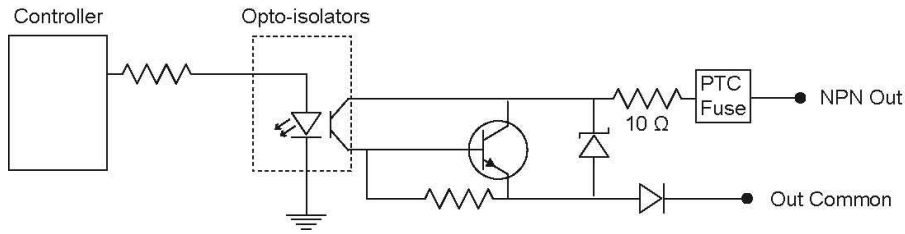

Specification	Description
Voltage	28V maximum through external load
Current	50mA maximum sink current
	OFF state leakage current 100µA
	External load resistance 240 Ohms to 10K Ohms
	Each line rated at a maximum 50mA, protected against over-current, short circuits and transients from switching inductive loads. High current inductive loads require external protection diode.

For PNP lines, the external load should be connected between the output and the negative supply voltage (0V). When connected to a 24VDC power supply, the outputs pull up greater than 21V when ON, and current flows through the load. When the outputs are OFF, no current flows through the load.

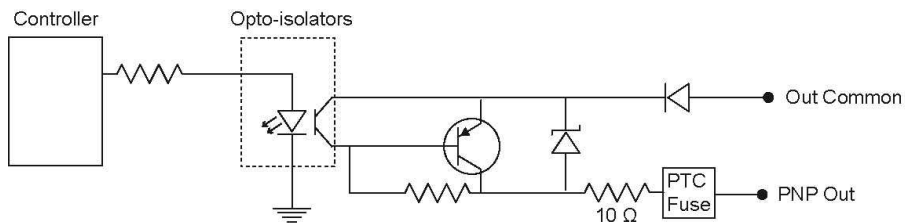

High-Speed Output Wiring

To connect to an NPN-compatible PLC input, connect Output 0, Output 1, Output 2, or Output 3 directly to the PLC input. When enabled, the output pulls the PLC input down to less than 3 V.

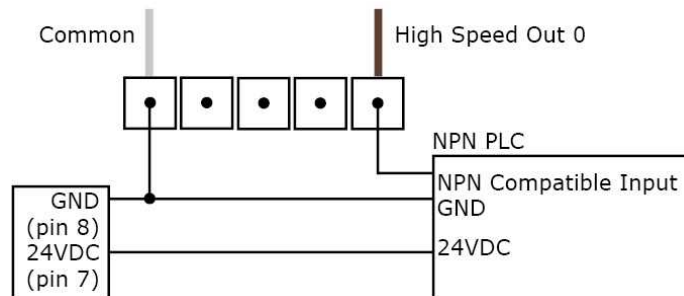

To connect to a PNP-compatible PLC input, connect Output 0 or Output 1 directly to the PLC input. When enabled, the output pulls the PLC input up to greater than 21 V.

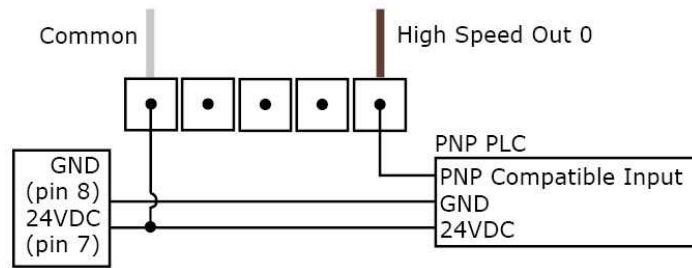

To connect the high-speed outputs to a relay, LED or similar load, connect the negative side of the load to the output and the positive side to +24 V. When the output switches on, the negative side of the load is pulled down to less than 3 V, and 24 appears across the load. Use a protection diode for a large inductive load, with the anode connected to the output and the cathode connected to +24 V.

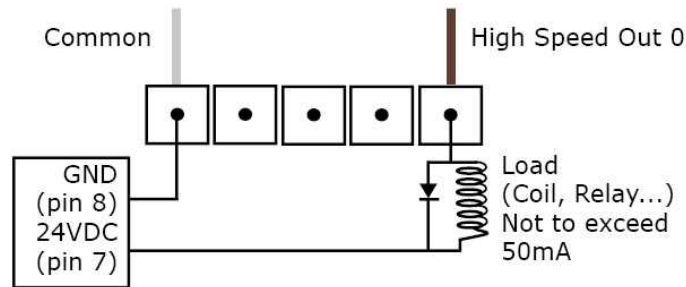

Ethernet M12 to RJ45 Cable (CCB-84901-y00x-xx)

The Ethernet cable provides Ethernet connection for network communications. The Ethernet cable can be connected to a single device or provide connections to multiple devices via a network switch or router.

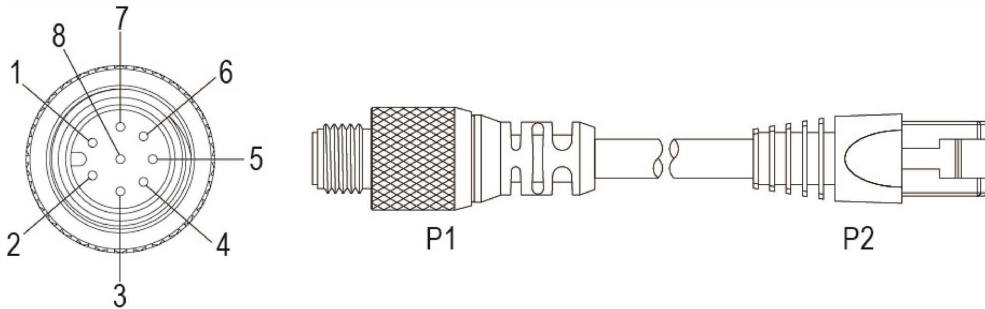

P1 Pin#	Signal Name	Wire Color	P2 Pin#
6	TPO+	White/Orange	1
4	TPO-	Orange	2
5	TPI+	White/Green	3
7	TRMA	Blue	4
1	TRMB	White/Blue	5
8	TPI+	Green	6
2	TRMC	White/Brown	7
3	TRMD	Brown	8

Note: Cables are sold separately. The wiring for this cable follows standard industrial Ethernet M12 specifications. This differs from the 568B standard.

Acquisition Triggering

The acquisition trigger input on the reader is opto-isolated. To trigger from an NPN (pull-down) type photo-detector or PLC output, connect **Common In** to +24VDC and connect **In 0** to the output of the detector. When the output turns on, it pulls **Common In** down to 0VDC, turning the opto-coupler on.

To trigger from an PNP (pull-up) photo-detector or PLC output, connect **In 0** to the output of the detector and connect **Common In** to 0VDC. When the output turns on, it pulls **In 0** up to 24VDC, turning the optocoupler ON.

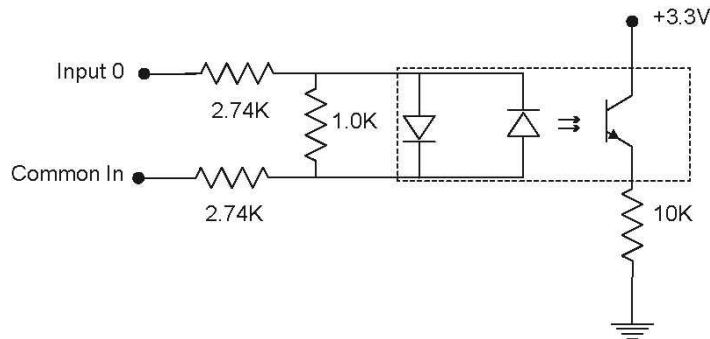

28V Max. across input pins - Transition approximately 12V (Min.)

Cleaning and Maintenance

Cleaning the Reader Housing

To clean the outside of the reader housing, use a small amount of mild detergent cleaner or isopropyl alcohol on a cleaning cloth. Do not pour the cleaner directly onto the reader housing.

 **CAUTION:** Do not attempt to clean any DataMan product with harsh or corrosive solvents, including lye, methyl ethyl ketone (MEK) or gasoline.

Cleaning the Reader Lens Cover

To remove dust from the lens cover, use a pressurized air duster. The air must be free of oil, moisture or other contaminants that could remain on the lens cover. To clean the plastic window of the lens cover, use a small amount of isopropyl alcohol on a cleaning cloth. Do not scratch the plastic window. Do not pour the alcohol directly on the plastic window.

Compliance Information, Warnings and Notices

Warnings and Notices

 **CAUTION:** IP protection is ensured only when all connectors are attached to cables or shielded by a sealing cap.

 **Note:** For product support, contact <http://support.cognex.com>.

 **CAUTION:** Use of controls or adjustments or performance of procedures other than those specified herein may result in serious injury.



- Do not attempt to service or repair this product - return it to Cognex for service.
- Do not permit anyone other than Cognex Corporation to service, repair, or adjust this product.
- Do not attempt to open or modify this device except as described in this document.
- Do not operate this device if it is damaged or if the covers or seals are missing or damaged.
- This product is intended for industrial use in automated manufacturing or similar applications.
- The safety of any system incorporating this product is the responsibility of the assembler of the system.
- This product does not contain user-serviceable parts. Do not make electrical or mechanical modifications to product components. Unauthorized modifications can void your warranty.
- This device should be used in accordance with the instructions in this manual.

Compliance Statements

The DataMan 503 series meets or exceeds the requirements of all applicable standards organizations for safe operation. However, as with any electrical equipment, the best way to ensure safe operation is to operate them according to the agency guidelines that follow. Please read these guidelines carefully before using your device.

Regulator	Specification
USA	FCC Part 15, Subpart B, Class A
Canada	ICES-003, Class A
European Community	EN55022 Class A EN55024 EN60950
Australia	AS/NZS for Class A Equipment
Korea	KCC-REM-CGX-DM503

Note: For the most current CE declaration and regulatory conformity information, see the Cognex support site: cognex.com/support.

Safety and Regulatory	
European Compliance 	<p>This is a class A product. In a domestic environment this product may cause radio interference in which case the user may be required to take immediate measures. This equipment complies with the essential requirements of the EU Directive 2014/30/EU. Declarations are available from your local representative. The CE mark on the product indicates that the system has been tested to and conforms with the provisions noted within the 2014/30/EU Electromagnetic Compatibility Directive. For further information please contact: Cognex Corporation, One Vision Drive Natick, MA 01760 USA.</p> <p>Cognex Corporation shall not be liable for use of our product with equipment (i.e., power supplies, personal computers, etc.) that is not CE.</p>
FCC Class A Compliance Statement 	<p>This equipment has been tested and found to comply with the limits for a Class A digital device, pursuant to Part 15 of the FCC rules. These limits are designed to provide reasonable protection against harmful interference when the equipment is operated in a commercial environment. This equipment generates, uses, and can radiate radio frequency energy and, if not installed and used in accordance with the instructions, may cause harmful interference to radio communications. Operation of this equipment in a residential area is likely to cause harmful interference, in which case the user will be required to correct the interference at personal expense.</p>
Canadian Compliance 	<p>This Class A digital apparatus complies with Canadian ICES-003. Cet appareil numérique de la classe A est conforme à la norme NMB-003 du Canada.</p>
C-Tick Statement 	<p>Conforms to AS/NZS CISPR 22/ EN 55022 for Class A Equipment.</p>
TÜV 	<p>NTRL: TÜV SÜD SCC/NRTL OSHA Scheme for UL/CAN 61010-1. CB report available upon request. TÜV SÜD, IEC/EN 61010-1.</p>

For European Community Users

Cognex complies with Directive 2012/19/EU OF THE EUROPEAN PARLIAMENT AND OF THE COUNCIL of 4 July 2012 on waste electrical and electronic equipment (WEEE).

This product has required the extraction and use of natural resources for its production. It may contain hazardous substances that could impact health and the environment, if not properly disposed.

In order to avoid the dissemination of those substances in our environment and to diminish the pressure on the natural resources, we encourage you to use the appropriate take-back systems for product disposal. Those systems will reuse or recycle most of the materials of the product you are disposing in a sound way.



The crossed out wheeled bin symbol informs you that the product should not be disposed of along with municipal waste and invites you to use the appropriate separate take-back systems for product disposal.

If you need more information on the collection, reuse, and recycling systems, please contact your local or regional waste administration.

You may also contact your supplier for more information on the environmental performance of this product.

