

COGNEX

DataMan[®] 475 Verifier **Quick Reference Guide**

2021 March 19
Revision: 6.2.3.1

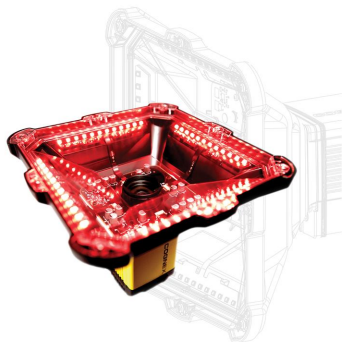

Precautions

To reduce the risk of injury or equipment damage, observe the following precautions when you install the Cognex product:

- The verifier is intended to be supplied by a UL or NRTL listed power supply with a 24VDC output rated for at least 2A continuous and a maximum short circuit current rating of less than 8A and a maximum power rating of less than 100VA and marked Class 2 or Limited Power Source (LPS). Any other voltage creates a risk of fire or shock and can damage the components. Applicable national and local wiring standards and rules must be followed.
- Route cables and wires away from high-current wiring or high-voltage power sources to reduce the risk of damage or malfunction from the following causes: over-voltage, line noise, electrostatic discharge (ESD), power surges, or other irregularities in the power supply.
- Do not install Cognex products where they are exposed to environmental hazards such as excessive heat, dust, moisture, humidity, impact, vibration, corrosive substances, flammable substances, or static electricity.
- Do not expose the image sensor to laser light. Image sensors can be damaged by direct, or reflected, laser light. If your application requires laser light that might strike the image sensor, use a lens filter at the corresponding laser wavelength. For suggestions, contact your local integrator or application engineer.
- Changes or modifications not expressly approved by the party responsible for regulatory compliance could void the user's authority to operate the equipment.
- Include service loops with cable connections.

- Ensure that the cable bend radius begins at least six inches from the connector. Cable shielding can be degraded or cables can be damaged or wear out faster if a service loop or bend radius is tighter than 10X the cable diameter.
- This device should be used in accordance with the instructions in this manual.
- All specifications are for reference purposes only and can change without notice.

Symbols

The following symbols indicate safety precautions and supplemental information:

 **WARNING:** This symbol indicates a hazard that could cause death, serious personal injury or electrical shock.

 **CAUTION:** This symbol indicates a hazard that could result in property damage.

 **Note:** This symbol indicates additional information about a subject.

 **Tip:** This symbol indicates suggestions and shortcuts that might not otherwise be apparent.

Product Overview

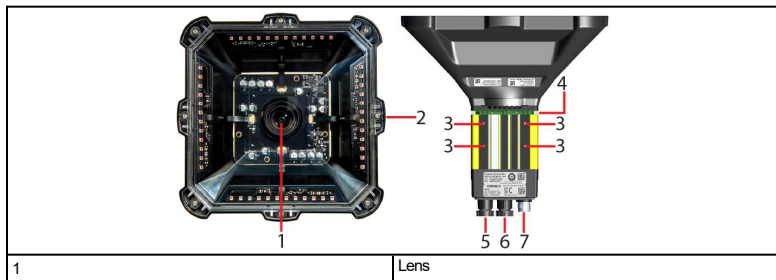











| | |
|---|--|
| 2 | Label Light attachment |
| 3 | Mounting holes (M3 x 5mm) |
| 4 | Indicator light ring |
| 5 | Ethernet connection |
| 6 | External lighting connection (disabled for verification) |
| 7 | Breakout cable connection |

DataMan 475 Accessories

Note: For ISO compliant verification, equip the DM475V with LabelLight 45° lighting accessory (DMV-475V-LBL-0200). Use other light accessories for DM475V for Standards Based Grading only.

Note: The product images below serve illustration purposes only. You can purchase the following components separately. For a list of options and accessories, contact your local Cognex sales representative.

| Accessory Name | Accessory Product Number | Accessory Illustration |
|--|-------------------------------|---|
| Power and I/O breakout cable, M12-12, straight, xx specifies length: 5 m, 10 m, 15 m, angled, xx specifies length: 5 m, 10 m, 15 m | CCB-PWRIO-xx CCB-PWRIO-xxR |  |
| X-Coded to A-Coded Ethernet cable adapter, 0.5 m | CCB-M12X8MS-XCAC |  |
| X-Coded to RJ45 Ethernet Cable. xx specifies length: 2 m, 5 m, 15 m, 30 m | CCB-84901-2001-xx |  |

| Accessory Name | Accessory Product Number | Accessory Illustration |
|--|--------------------------|---|
| I/O extension cable, 5 m straight | CKR-200-CBL-EXT |  |
| Connection module (up to 4 cameras including network switch) xx can be US, EU, UK or JP | DMA-CCM-4X-xx |  |
| Connection module (1 camera) xx can be US, EU, UK or JP | DMA-CCM-1-xx |  |
| Mounting Bracket Kit | DMBK-470-MNT |  |
| Pivot Mounting Bracket | DM100-PIVOTM-00 |  |
| External heat sink | DMHS-370-470 |  |
| 45° LabelLight | DMV-475V-LBL-0200 |  |

Dimensions

DataMan 475 Verifier

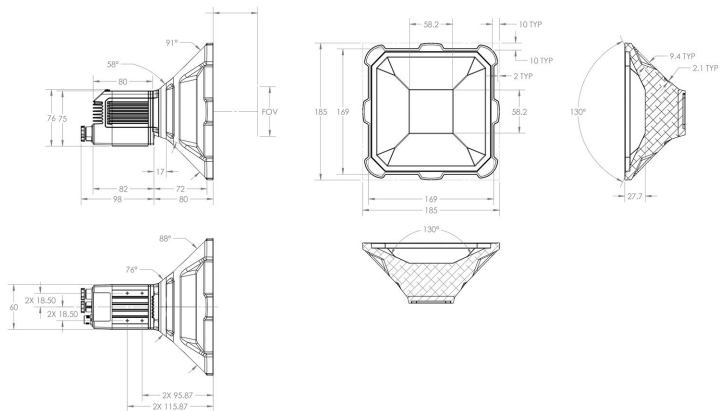

Mounting and Connecting the Verifier

CAUTION: The Ethernet cable shield must be grounded at the far end.



Whatever this cable is plugged into (usually a switch or router) should have a grounded Ethernet connector. A digital voltmeter should be used to validate the grounding. If the far end device is not grounded, a ground wire should be added in compliance with local electrical codes.



CAUTION: To reduce emissions, connect the far end of the Breakout cable shield to frame ground.

Perform the following steps:

1. Mount the verifier so that the distance from the bottom of the light housing to the plane of the code is 60 mm.



Tip: Measure each corner of the light housing to 60 mm (+/- 3 mm).

2. Connect the Ethernet cable to a computer or a network switch.
3. Connect the breakout cable to a 24 V power supply.

For information on the cable pinout and wire colors, see section *Connections, Optics, and Lighting* in the *DataMan 475 Verifier Reference Manual*.

Note:



- Cables are sold separately.
- If a standard component is missing or damaged, immediately contact your Cognex Authorized Service Provider (ASP) or Cognex Technical Support.

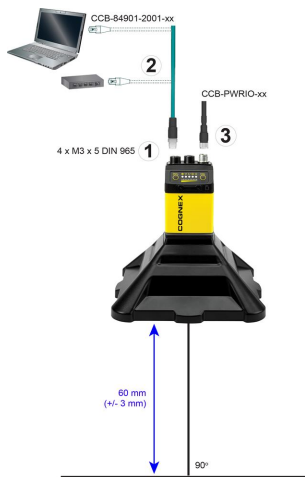

CAUTION: All cable connectors are "keyed" to fit the connectors on the DataMan system; do not force the connectors or damage may occur.

CAUTION: It is recommended the verifier be grounded, either by mounting the verifier to a fixture that is electrically grounded or by attaching a wire from the verifier's mounting fixture to frame ground or Earth ground. If a ground wire is used, it should be attached to one of the four mounting points on the back plate of the verifier; not to the mounting points on the front of the verifier.

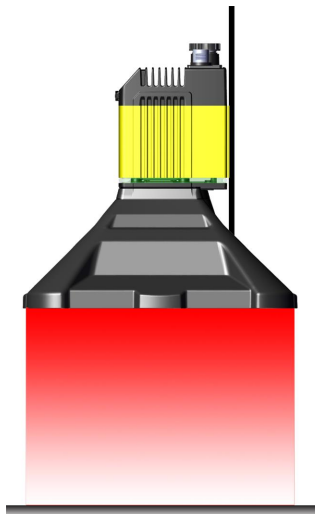

Connect the Ethernet Cable

CAUTION: The Ethernet cable shield must be grounded at the far end.



Whatever this cable is plugged into (usually a switch or router) should have a grounded Ethernet connector. A digital voltmeter should be used to validate the grounding. If the far end device is not grounded, a ground wire should be added in compliance with local electrical codes.

1. Connect the Ethernet cable's M12 connector to the DataMan system's ENET connector.
2. Connect the Ethernet cable's RJ-45 connector to a switch/router or PC, as applicable.

Connect the Breakout Cable



CAUTION: To reduce emissions, connect the far end of the Breakout cable shield to frame ground.

Note:



- I/O wiring or adjustments to I/O devices should be performed when the verifier is not receiving power.
- You can clip unused wires short or use a tie made of non-conductive material to tie them back. Keep bare wires separated from the +24 VDC wire.

1. Verify that the 24 VDC power supply is unplugged and not receiving power.
 2. Attach the Breakout cable's +24 VDC and Ground to the corresponding terminals on the power supply.
-



CAUTION: Never connect voltages other than 24 VDC. Always observe the polarity shown.

3. Attach the Breakout cable's M12 connector to the DataMan 475 verifier's 24 VDC connector.
4. Restore power to the 24 VDC power supply and turn it on if necessary.

Software Installation

Installation procedures and specifications are presented in detail in the *DataMan 475 Verifier Reference Manual*, which is installed with the DataMan Setup Tool. From the Windows Start menu, select the following to access the manual: *All Programs > Cognex > DataMan Software vx.x.x > Documentation*.

To configure a DataMan 475 verifier, the DataMan Setup Tool software must be installed on a networked PC. The DataMan Setup Tool is available from the [DataMan support site](#).

 **Note:** The DM475 verifier is not supported in versions earlier than 6.1.7.

1. After installing the software, connect the DataMan 475 verifier to your PC.
2. Launch the DataMan Setup Tool and click **Refresh**.
3. Select your DataMan 475 verifier from the list and click **Connect**.

DataMan 475 Verifier Specifications



| Specification | DataMan 475 Verifier |
|------------------------------------|---|
| Weight | 945 g |
| Field of View | 80 x 60 mm |
| Dimensions | 185 x 185 x 175 mm |
| Power Consumption | <ul style="list-style-type: none"> 24 VDC \pm10%, 1.5 A maximum (Label Light, 36 W peak power consumption) Supplied by LPS or NEC class 2 only. |
| Light Connector | 0.4 A |
| |  Note: The Light Connector is disabled while the Label Light accessory is in place. |
| Case Temperature ¹ | 0 °C - 57 °C (32 °F - 134.6 °F) |
| Operating Temperature ² | 0 °C - 40 °C (32 °F - 104 °F) |
| Storage Temperature | -20 °C - 80 °C (-4 °F - 176 °F) |
| Humidity | < 95% non-condensing |
| Environmental | IP65 with cables attached. |
| Shock (Shipping and Storage) | IEC 60068-2-27: 18 shocks (3 shocks in each polarity in each (X, Y, Z) axis) 80 Gs (800 m/s ² at 11 ms, half-sinusoidal) with cables or cable plugs and appropriate lens cover attached. |
| Vibration (Shipping and Storage) | IEC 60068-2-6: vibration test in each of the three main axis for 2 hours @ 10 Gs (10 to 500 Hz at 100 m/s ² / 15 mm) with cables or cable plugs and appropriate lens cover attached. |
| Supported Symbolologies | 1D codes: Codabar, Code 39, Code 128, and Code 93, Interleaved 2 of 5, UPC/EAN/JAN 2D codes: Data Matrix (ECC 200), QR Code, microQR Code Stacked codes: PDF 417 |

¹ Additional cooling measures may be required to keep the case temperature from exceeding 50 °C. Examples of such measures include: extra heat sinking and/or air movement.

² In situations where the operating temperature exceeds 40 °C, an external heat sink is required.

| Specification | DataMan 475 Verifier | | |
|-------------------------------|----------------------------------|-----------|--|
| Discrete I/O operating limits | HS Output 0,1,2,3 | I_{MAX} | 50 mA |
| | | R_{MIN} | @ 12 VDC 200 Ω |
| | Input 0 (Trigger) Input 1,2,3 | V_{IH} | $\pm 15 - \pm 28$ V |
| | | V_{IL} | $0 - \pm 5$ V |
| | | I_{TYP} | @ 12 VDC 2.0 mA @ 24 VDC 4.2 mA |
| Ethernet Speed | 10/100/1000 | | |

DataMan 475 Verifier Imager Specifications

| Specification | DataMan 475 Imager |
|--------------------------------------|---|
| Image Sensor | 2/3 inch CMOS, global shutter |
| Image Sensor Properties | 8.8 mm x 6.6 mm (H x V); 3.45 μ m square pixels |
| Image Resolution (pixels) | 2448 x 2048 |
| Electronic Shutter Speed | Fixed at 30 μ s for ISO 15415 compliance. Auto adjusted exposure for ISO 29158 (AIM-DPM) compliance. |
| |  Note: If the user adjusts the shutter speed, there is no guarantee that the verifier retains compliance. |
| Image Acquisition at Full Resolution | 37 Hz for imager without lighting. |
| |  Note: Max. acquisition speed with 45 lighting degree accessory enabled is significantly less. Practical acquisition rate is application dependent. |
| Lens Type | 12 mm fixed focal length, f/4 fixed aperture, 2/3 inch sensor format, C-mount lens (users cannot alter or replace it). |

LED Wavelengths

The following table shows LED types and the related peak wavelengths:

| LED | λ [nm] |
|-----|----------------|
| RED | 660 |

Regulations/Conformity

i Note: For the most current CE declaration and regulatory conformity information, see the Cognex support site: cognex.com/support.

DataMan 475 verifiers have Regulatory Model R00062, Label Light (DMV-475V-LBL-0200) has Accessory Model 50162, and meet or exceed the requirements of all applicable standards organizations for safe operation. However, as with any electrical equipment, the best way to ensure safe operation is to operate them according to the agency guidelines that follow. Please read these guidelines carefully before using your device.

| Safety and Regulatory | |
|-----------------------|---|
| Manufacturer | Cognex Corporation One Vision Drive Natick, MA 01760 USA |
| USA | TÜV SÜD SCC/NRTL OSHA Scheme for UL/CAN 61010-1. FCC Part 15, Class A This equipment has been tested and found to comply with the limits for a Class A digital device, pursuant to part 15 of the FCC Rules. These limits are designed to provide reasonable protection against harmful interference when the equipment is operated in a commercial environment. This equipment generates, uses, and can radiate radio frequency energy and, if not installed and used in accordance with the instruction manual, may cause harmful interference to radio communications. Operation of this equipment in a residential area is likely to cause harmful interference in which case the user will be required to correct the interference at his own expense. |
| Canada | TÜV SÜD SCC/NRTL OSHA Scheme for UL/CAN 61010-1. ICES-003, Class A This Class A digital apparatus complies with Canadian ICES-003. Cet appareil numérique de la classe A est conforme à la norme NMB-003 du Canada. |

| Safety and Regulatory | |
|------------------------------|---|
| Europe | DM475 (Regulatory Model R00062) Label Light (DMV-475V-LBL-0200) (Accessory Model 50162) The CE mark on the product indicates that the system has been tested to and conforms to the provisions noted within the 2014/30/EU Electromagnetic Compatibility Directive and the 2011/65/EU RoHS Directive. For further information, please contact: Cognex Corporation, One Vision Drive, Natick, MA 01760, USA. Cognex Corporation shall not be liable for use of our product with equipment (i.e., power supplies, personal computers, etc.) that is not CE. |
| Korea | A급 기기(업무용 방송통신기자재): 이 기기는 업무용(A급) 전자파적합기기로서 판매자 또는 사용자는 이 점을 주의하시기 바라며, 가정외의 지역에서 사용하는 것을 목적으로 합니다. DM475 (Regulatory Model R00062) Label Light (DMV-475V-LBL-0200) (Accessory Model 50162) |
| International Product Safety | Conforms to IEC 61010-1, CAN/CSA-C22.2 No. 61010-1:2012 + UPD No. 1:2015-07, UL 61010-1:2012 + R:2015-07, UL 61010-1:2012 + R:2015-07, EN 61010-1:2010. |
| CB | TÜV SÜD IEC/EN 61010-1. CB report available upon request. |

For European Community Users

Cognex complies with Directive 2012/19/EU OF THE EUROPEAN PARLIAMENT AND OF THE COUNCIL of 4 July 2012 on waste electrical and electronic equipment (WEEE).

This product has required the extraction and use of natural resources for its production. It may contain hazardous substances that could impact health and the environment, if not properly disposed.

In order to avoid the dissemination of those substances in our environment and to diminish the pressure on the natural resources, we encourage you to use the appropriate take-back systems for product disposal. Those systems will reuse or recycle most of the materials of the product you are disposing in a sound way.



The crossed out wheeled bin symbol informs you that the product should not be disposed of along with municipal waste and invites you to use the appropriate separate take-back systems for product disposal.

If you need more information on the collection, reuse, and recycling systems, please contact your local or regional waste administration.

You may also contact your supplier for more information on the environmental performance of this product.

中国大陆RoHS (Information for China RoHS Compliance)

根据中国大陆《电子信息产品污染控制管理办法》(也称为中国大陆RoHS), 以下部份列出了本产品中可能包含的有毒有害物质或元素的名称和含量。



Table of toxic and hazardous substances/elements and their content, as required by China's management methods for controlling pollution by electronic information products.

| Part Name 部件名称 | Hazardous Substances 有害物质 | | | | | |
|---|---------------------------|----------------------|----------------------|--|---|--|
| | Lead (Pb) 铅 | Mercury (Hg) 汞 | Cadmium (Cd) 镉 | Hexavalent Chromium (Cr (VI)) 六价铬 | Polybrominated biphenyls (PBB) 多溴联苯 | Polybrominated diphenyl ethers (PBDE) 多溴二苯醚 |
| | X | O | O | O | O | O |
| This table is prepared in accordance with the provisions of SJ/T 11364. 这个标签是根据SJ/T 11364 的规定准备的。 | | | | | | |
| O: Indicates that said hazardous substance contained in all of the homogeneous materials for this part is below the limit requirement of GB / T26572 - 2011. 表示本部件所有均质材料中含有的有害物质低于GB / T26572 - 2011 的限量要求。 | | | | | | |
| X: Indicates that said hazardous substance contained in at least one of the homogeneous materials used for this part is above the limit requirement of GB / T26572 - 2011. 表示用于本部件的至少一种均质材料中所含的危害物质超过GB / T26572 - 2011 的限制要求。 | | | | | | |

Copyright © 2020
Cognex Corporation. All Rights Reserved.