

COGNEX

MX-1000 **Reference Manual**

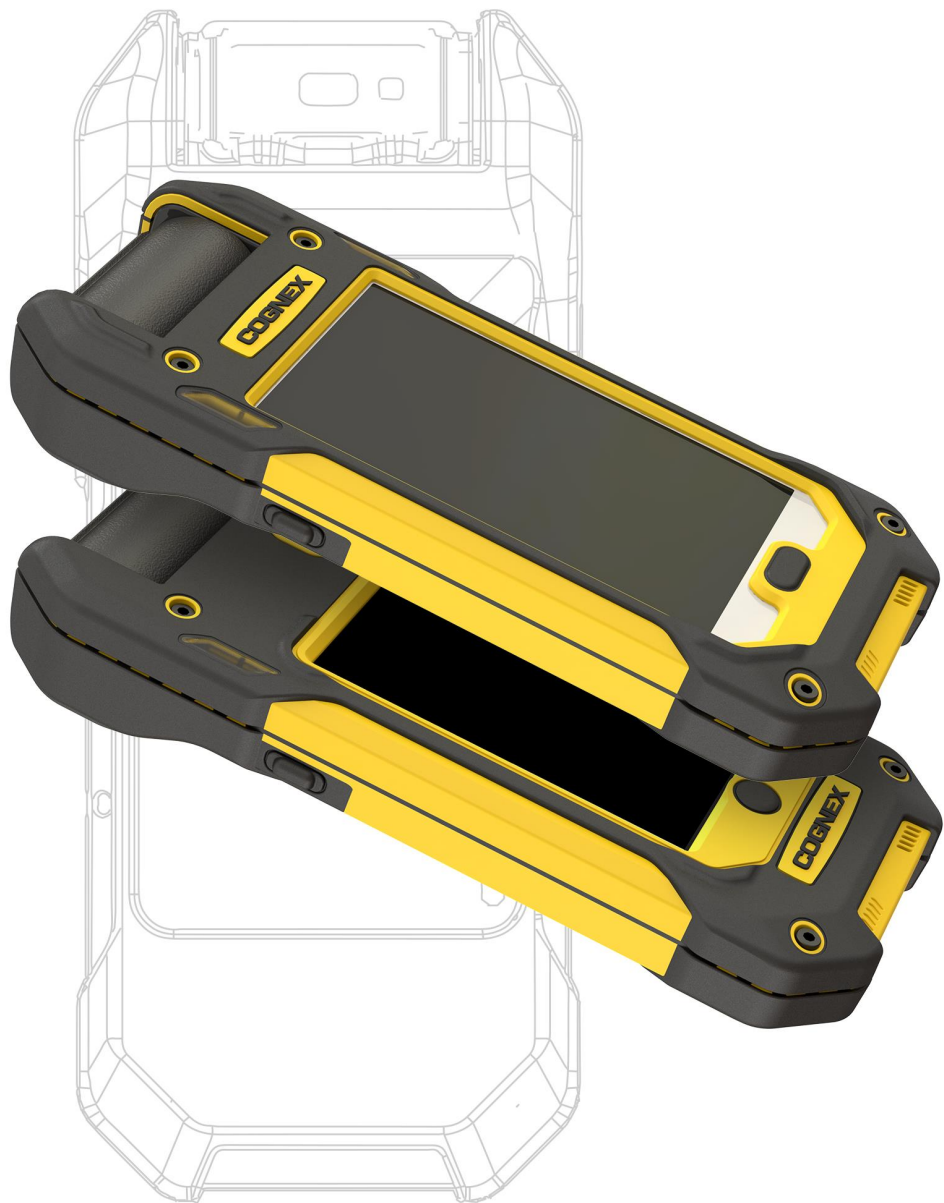

2021 February 24
Revision: 6.2.1.1

Legal Notices

The software described in this document is furnished under license, and may be used or copied only in accordance with the terms of such license and with the inclusion of the copyright notice shown on this page. Neither the software, this document, nor any copies thereof may be provided to, or otherwise made available to, anyone other than the licensee. Title to, and ownership of, this software remains with Cognex Corporation or its licensor. Cognex Corporation assumes no responsibility for the use or reliability of its software on equipment that is not supplied by Cognex Corporation. Cognex Corporation makes no warranties, either express or implied, regarding the described software, its merchantability, non-infringement or its fitness for any particular purpose.

The information in this document is subject to change without notice and should not be construed as a commitment by Cognex Corporation. Cognex Corporation is not responsible for any errors that may be present in either this document or the associated software.

Companies, names, and data used in examples herein are fictitious unless otherwise noted. No part of this document may be reproduced or transmitted in any form or by any means, electronic or mechanical, for any purpose, nor transferred to any other media or language without the written permission of Cognex Corporation.

Copyright © 2020. Cognex Corporation. All Rights Reserved.

Portions of the hardware and software provided by Cognex may be covered by one or more U.S. and foreign patents, as well as pending U.S. and foreign patents listed on the Cognex web site at: cognex.com/patents.

The following are registered trademarks of Cognex Corporation:

Cognex, 2DMAX, Advantage, AlignPlus, Assemblyplus, Check it with Checker, Checker, Cognex Vision for Industry, Cognex VSOC, CVL, DataMan, DisplayInspect, DVT, EasyBuilder, Hotbars, IDMax, In-Sight, Laser Killer, MVS-8000, OmniView, PatFind, PatFlex, PatInspect, PatMax, PatQuick, SensorView, SmartView, SmartAdvisor, SmartLearn, UltraLight, Vision Solutions, VisionPro, VisionView

The following are trademarks of Cognex Corporation:

The Cognex logo, 1DMax, 3D-Locate, 3DMax, BGAll, CheckPoint, Cognex VSoC, CVC-1000, FFD, iLearn, In-Sight (design insignia with cross-hairs), In-Sight 2000, InspectEdge, Inspection Designer, MVS, NotchMax, OCRMax, PatMax RedLine, ProofRead, SmartSync, ProfilePlus, SmartDisplay, SmartSystem, SMD4, VisiFlex, Xpand

Portions copyright © Microsoft Corporation. All rights reserved.

Portions copyright © MadCap Software, Inc. All rights reserved.

Other product and company trademarks identified herein are the trademarks of their respective owners.

Table of Contents

Legal Notices	2
Table of Contents	3
Symbols	4
Getting Started	5
About MX-1000	5
MX-1000 Accessories	6
MX-1000 Layout	8
Layout of the Charging Station	9
Indicator LEDs	10
Dimensional Drawings	11
MX-1000 Specifications	12
Imager Specifications	12
LED Wavelengths	12
Charging Station Specifications	12
Setting up the MX-1000	13
Assembling the MX-1000	13
Assembling the Reader with the Pistol Grip	15
Charging	16
Charging an MX-1000 Using the Wireless Charging Station	17
USB Type-C Charging	20
Changing Battery in the MX-1000 Reader	20
Changing Battery in the Pistol Grip	22
Reading Codes with your MX-1000	24
Field of View and Reading Distances	24
Cleaning and Maintenance	26
Cleaning the Reader Housing	26
Cleaning the Reader Lens Cover	26
Compliance Statements	27
Compliance Statements: MX-1000 Charging Station	28
中国大陆 RoHS (Information for China RoHS Compliance)	29
Precautions	30

Symbols

The following symbols indicate safety precautions and supplemental information:

 **WARNING:** This symbol indicates a hazard that could cause death, serious personal injury or electrical shock.

 **CAUTION:** This symbol indicates a hazard that could result in property damage.

 **Note:** This symbol indicates additional information about a subject.

 **Tip:** This symbol indicates suggestions and shortcuts that might not otherwise be apparent.

Getting Started

This section provides general information about the Cognex MX-1000 Vision-Enabled Mobile Terminal (henceforth referred to as "MX-1000 reader"). You can also find information on the MX-1000 accessories and the physical layout of the reader and the charging station in this section.

About MX-1000



The Cognex MX-1000 reader is a handheld ID mobile device supporting an integrated user interface based on a consumer mobile device in an industrial grade housing. It features high-speed bar code reading performance in a modular, rugged design that supports a variety of 3rd party mobile devices. The MX-1000 reader provides the industry's most advanced technology for reading 1-D and 2-D codes. The MX-1000 also reads challenging 2-D DPM codes. It is designed to withstand heavy use in industrial settings. The unique modular design allows you to stay current with mobile communications technology and easily replace or upgrade components without the need for a service plan. The enhanced interface allows you to write and implement your own application according to the needs of your work environment.

The MX-1000 reader offers the following features:

- Wireless charging
- LED aimer and illumination
- No external connectors
- Vibro at the bottom part that ensures adequate feedback even in loud environments

The **MX-1000 Kit** includes the following:

- MX-1000 reader
- Battery
- Wrist strap

Note: A mobile device is necessary to work with the MX-1000 reader. The currently supported devices are:





- **Galaxy S6, S7, S8 S9**
- **Galaxy J3**
- **Galaxy A3**
- **Galaxy XCover 4**
- **iPhone SE, 5S, 6, 6S, 7, 8**
- **iPod touch generations 5th and 6th**



For more information, see <http://www.cognex.com>.

MX-1000 Accessories

Battery for reader (3120 mAh)	DMA-MTBATTERY-01	
Battery for pistol grip accessory (3070 mAh)	DMA-HHBATTERY-01	
Pistol grip Note: The grip features its own trigger button and an additional battery which can be charged via the charging station.	DMA-GRIP-01	
Belt holster	DMA-HOLSTER-01	
	DMA-HOLSTER-02	
Charging station (inductive)	DMA-MTBASE-US DMA-MTBASE-EU	
Charging station (non-inductive)	DMA-MTBASEP-US DMA-MTBASEP-EU	
Multi-device charger	DMA-MTBASE4-US DMA-MTBASE4-EU DMA-MTBASE4BKT-US DMA-MTBASE4BKT-EU	
Multi-battery charger	DMA-MBC-US DMA-MBC-EU	

Wireless car charger	DMA-VMCHARGER-00	
Power supply for charging station 24V/24W	DMA-24VPWR-US DMA-24VPWR-EU	
USB Type-C battery charger kits: 1. USB Type-C Battery Cover (DMA-MXUSB-00) + USB Type-C 3Amp Car Charger (DMA-MXUSB-CHARGER) 2. USB Type-C Battery Cover (DMA-MXUSB-00) + Handstrap (DMA-MXSTRAP-00) 3. USB Type-C Battery Cover (DMA-MXUSB-00) + USB Type-C 3Amp Car Charger (DMA-MXUSB-CHARGER) + Handstrap (DMA-MXSTRAP-00)	1. DMA-MXUSB-01	
	2. DMA-MXUSB-02	
	3. DMA-MXUSB-03	
Passive car holder ¹	DMA-VMHOLDER-00	
Top Cover	DMA-COVERKIT-S4 DMA-COVERKIT-S5 DMA-COVERKIT-S6 DMA-COVERKIT-S7 DMA-COVERKIT-S8 DMA-COVERKIT-S9 DMA-COVERKIT-J3 DMA-COVERKIT-J327 DMA-COVERKIT-J330 DMA-COVERKIT-A3 DMA-COVERKIT-X4 DMA-COVERKIT-I5 DMA-COVERKIT-I6 DMA-COVERKIT-iX DMA-COVERKIT-S10e DMA-COVERKIT-N42	

¹ Using or storing the device outside of the recommended temperature ranges may damage or reduce the lifespan of the battery. Leaving the MX Series Mobile Terminal with a mobile device in direct sunlight for an extended amount of time can raise the temperature above the recommended limit.

MX-1000 Layout

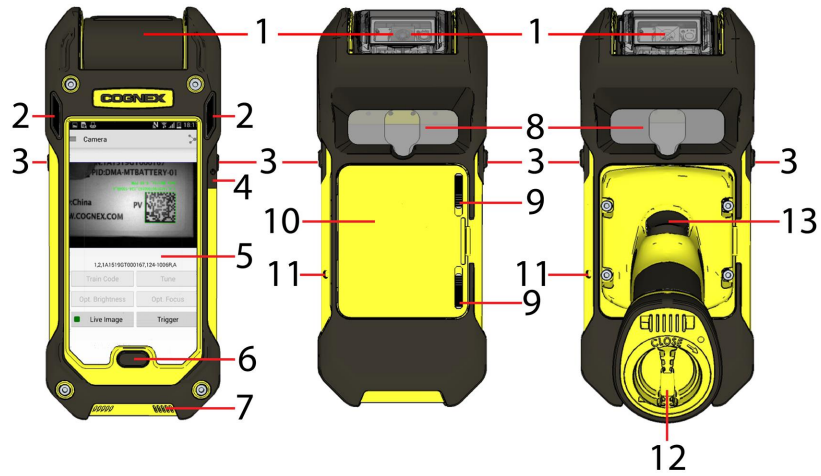

1	Scanner head (rotatable by 45°)
2	Indicator LEDs
3	Side trigger buttons
4	Power button
5	Touch screen
6	Home button
7	Speaker vents
8	Recessed area for mobile camera
9	Slider to lock battery cover
10	Battery cover
11	Lanyard hook
12	End cap of pistol grip*
13	Trigger button on the pistol grip*

*Pistol grip is optional

Layout of the Charging Station

Top view:

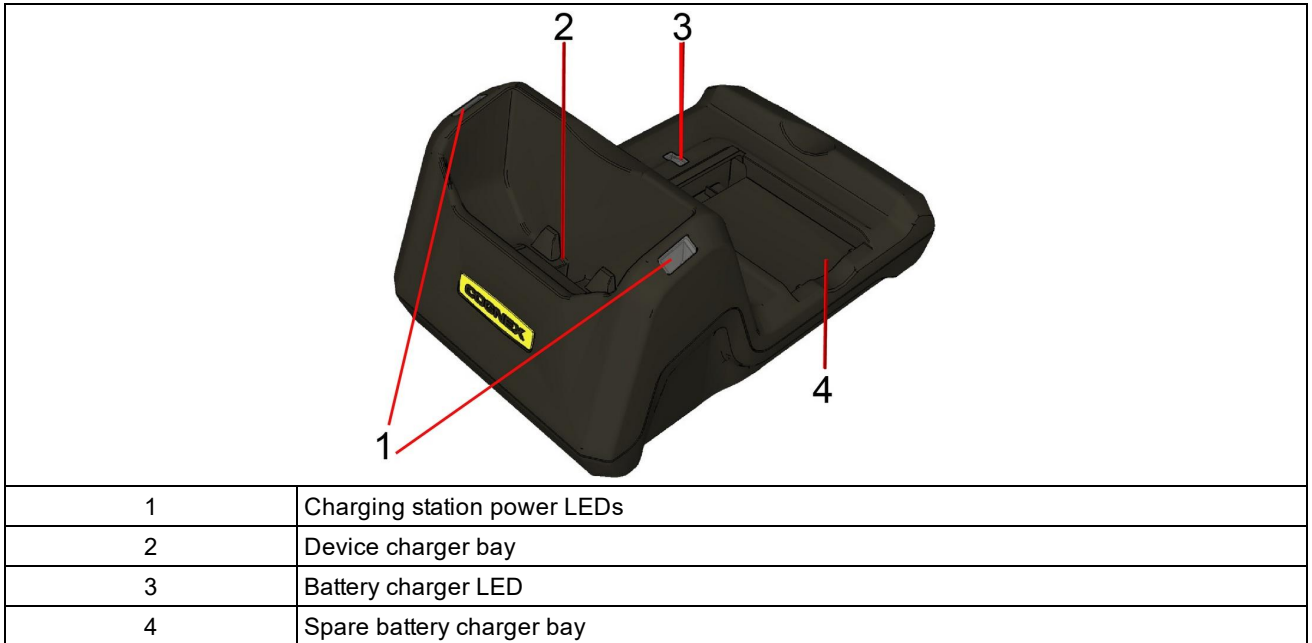

Bottom view:

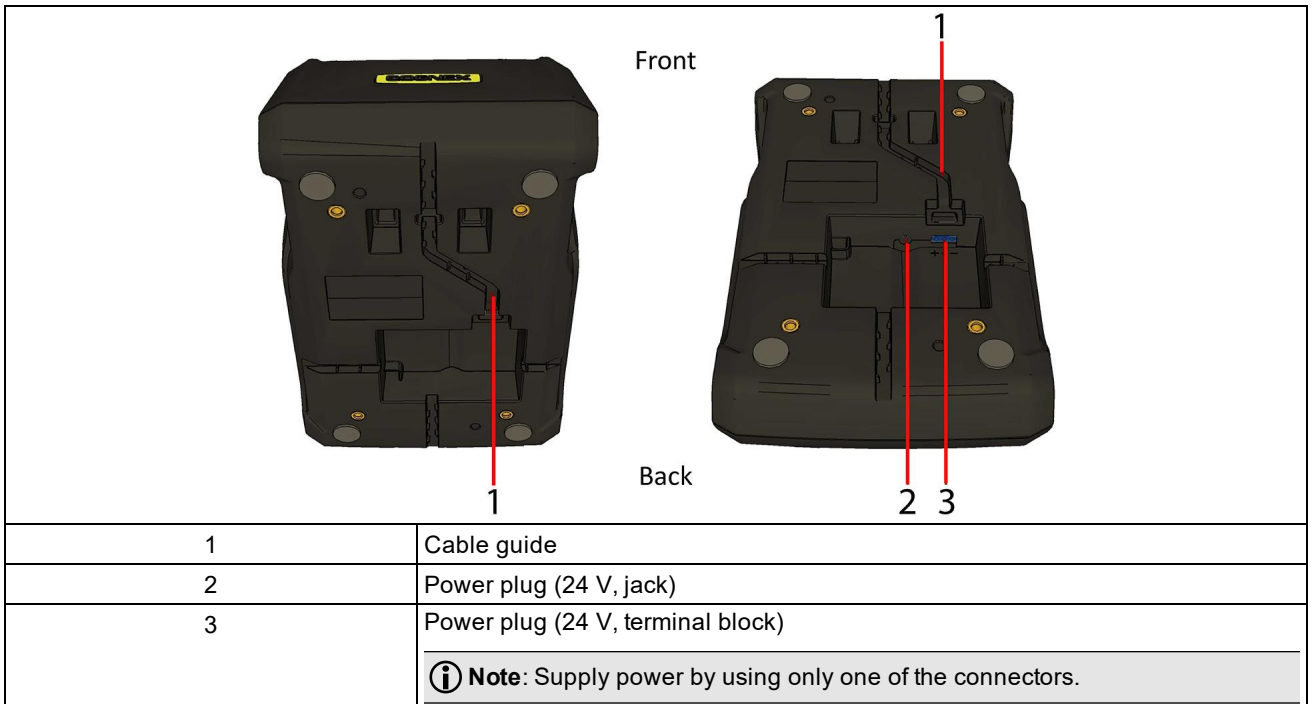

Indicator LEDs

MX-1000 indicator LEDs

Type	Signal	Color	Interval	Meaning
Status	Battery health	RED and GREEN	blinking	Battery health low
	Configuration	GREEN	2 short blinks/1 sec	Internal reconfiguration
	Overheat protection	RED	2 short blinks/1.5 sec	Overheat protection
Status standalone	Low battery status	RED	every 4 sec	Charged 15-10%
		RED	every 2 sec	Charged 10-8%
		RED	every 1 sec	Charged 8-5%
		RED	every 0.5 sec	Charged < 5%
Status base station	Charging	RED	continuous	Charging
	Charged	GREEN	continuous	Fully charged
	Error	RED	blinking	Charging error

Charging station power LEDs

Type	Signal	Color	Interval	Meaning
Status	Wireless power	RED	continuous	wireless power disconnected, there is no device in the charger bay
		GREEN	continuous	wireless power connected, charging is active

Battery charger LEDs

Type	Signal	Color	Interval	Meaning
Status	No battery inserted	N/A	N/A	Battery disconnected
	Battery charging	RED	continuous	Charging is active
	Error	RED	blinking	Charging error
	Charged	GREEN	continuous	Charged

Dimensional Drawings

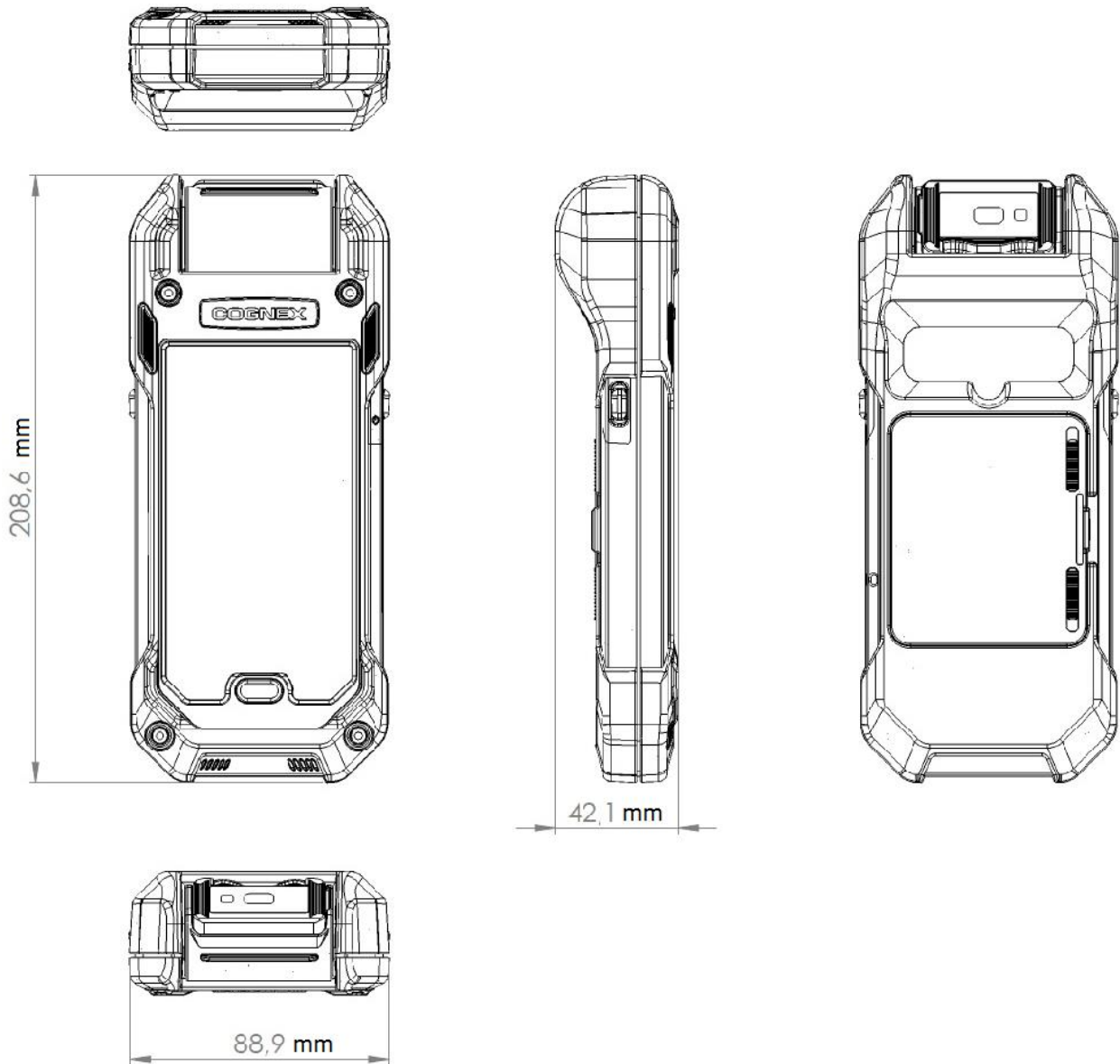

MX-1000 Specifications

Weight	510 g (675 g with pistol grip)
Operating Temperature	0°C — +40°C (+32°F — +104°F)
Storage Temperature	-40°C — +60°C (-40°F — +140°F)
Charging Temperature	0°C — +35°C (+32°F — +95°F)
Maximum Humidity	< 95% (non-condensing)
Environmental	IP65
Codes	1-D: UPC/EAN/JAN, Codabar, Interleaved 2 of 5, Code 39, Code 128, Code 93, Pharmacode, GS1 DataBar, PDF417, Micro PDF417 2-D: Data Matrix, QR Code, and MicroQR Code, DotCode and postal code
Power Supply Requirements	Battery power
Expected operating time for typical scan batches (400 scan per hour) with a fully charged battery	12 hours

Imager Specifications

Specification	MX-1000 Imager
Image Sensor	1/3 inch CMOS
Image Sensor Properties	6.0 µm square pixels
Image Resolution (Pixels)	752 x 480 global shutter sensor
Lens Type	6.2 mm with different focal positions for MX-1000 and MX-1100, M12 lens with IR blocking filter

LED Wavelengths

The following table shows LED types and the related wavelengths:

LED	λ [nm]
RED	617

Charging Station Specifications

Weight	380 g
Operating Temperature	0°C — +40°C (+32°F — +104°F)
Storage Temperature	-40°C — +60°C (-40°F — +140°F)
Maximum Humidity	95% (non-condensing)
Power Supply Requirements	24 V, 24 W maximum LPS or NEC Class 2 power supply 0.5A (inductive) and 1A (non-inductive)

Setting up the MX-1000

This section provides information on how to assemble, and how to set up your MX-1000 reader.

Assembling the MX-1000

The first step in preparing your MX-1000 is assembling the components of your **MX-1000 Kit**. The **MX-1000 Kit** contains the following components:

- Base unit
- Battery + cover
- Wrist strap

The phone-specific **DMA-COVERKIT** contains the following components:

- Top cover
- Rubber insert
- USB cable to connect the Base unit to the mobile device
- 4 Allen screws(M3) + Allen key

The **DMA-GRIP-01 Kit** contains the pistol grip and the pistol grip cable.

The following image shows the layering of the main kit components and the place of the mobile device among the components.

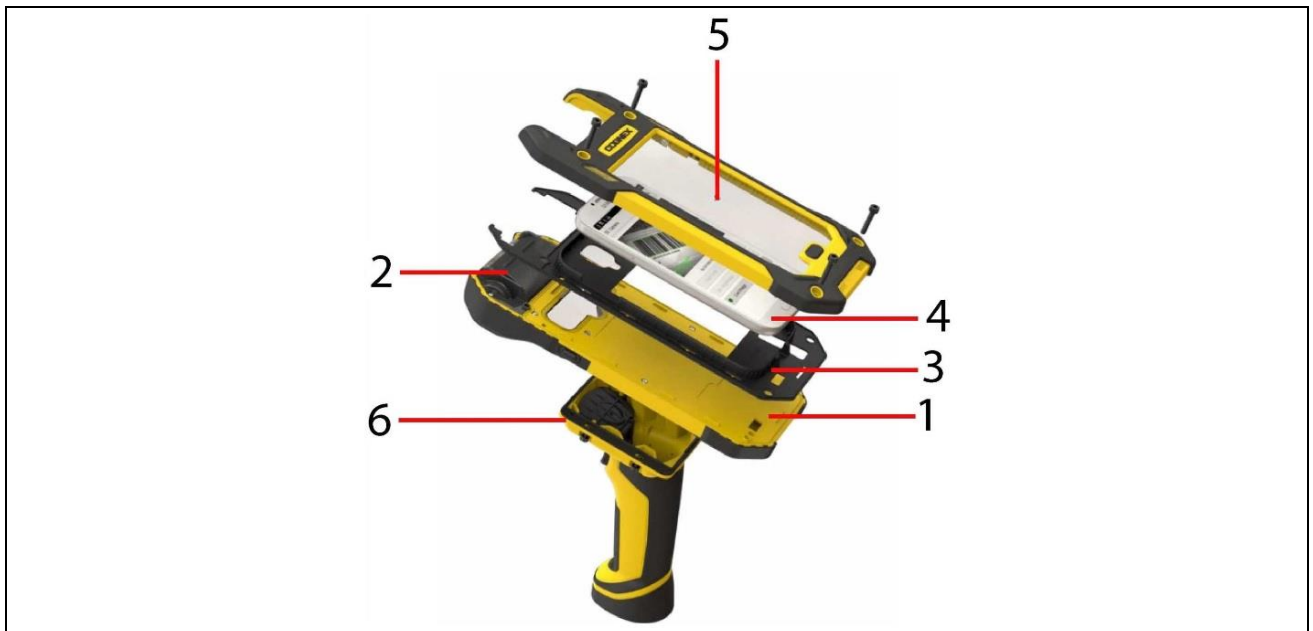

1	Base unit
2	Barcode reader
3	Rubber insert
4	Mobile device
5	Top cover
6	Pistol grip (optional)

Perform the following steps to assemble the MX-1000 reader:

1. Carefully place the **rubber insert** on the **base unit** which is the lower part of the reader.

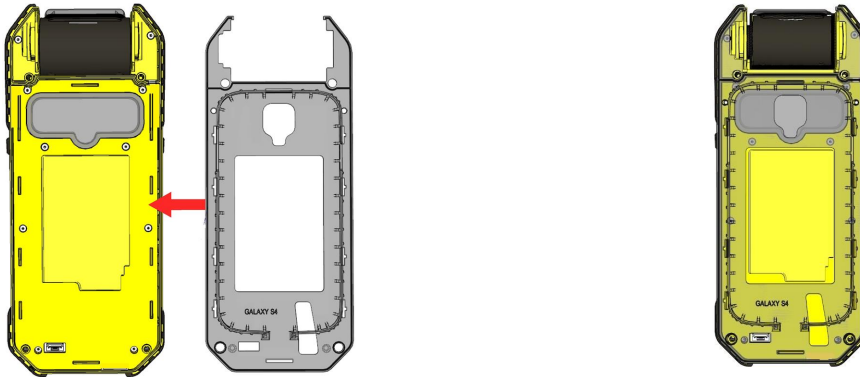

2. Take the provided **USB cable** and plug it into the **base unit**. Then take your phone and put it on the **rubber insert**. Connect it to the **base unit** by the **USB cable**.

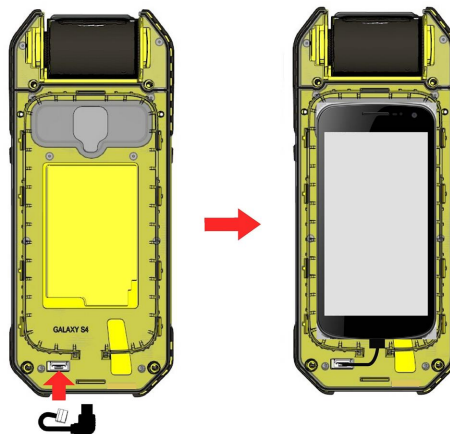

3. Fix the **top cover** by tightening the provided four Allen screws (recommended torque: 80 Ncm). Additionally, you can attach the **wrist strap** to the reader by passing one of the screws through the loop on the wrist strap.



Assembling the Reader with the Pistol Grip

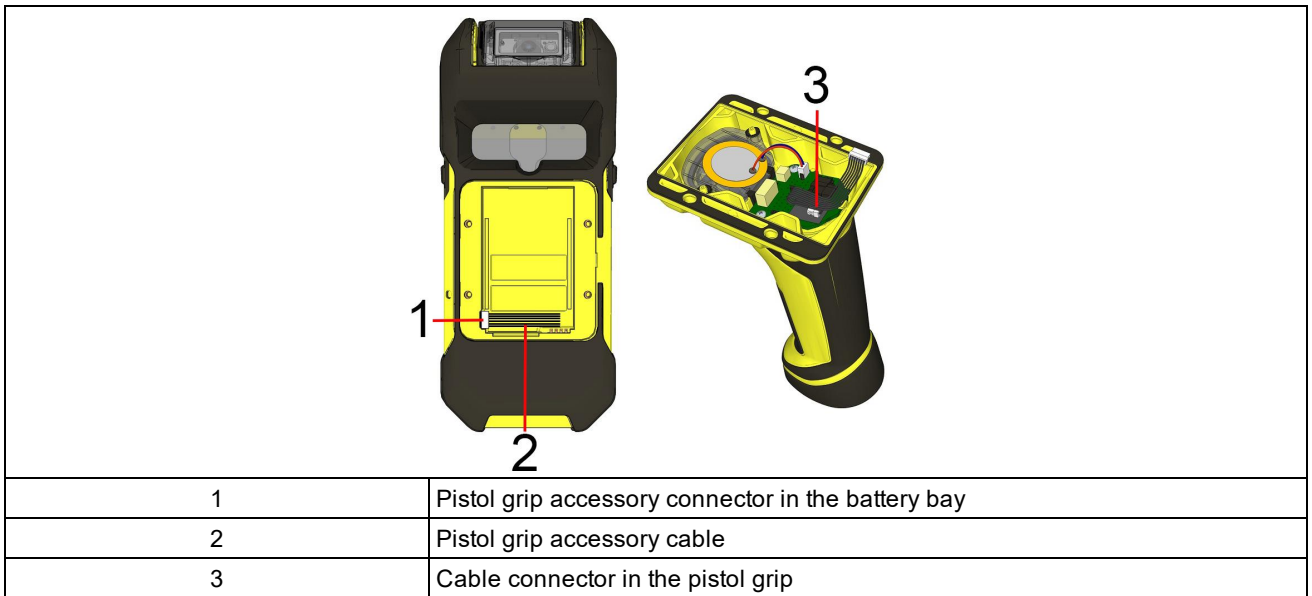

If you want to use your reader with a pistol grip, perform the following steps:

1. Open the back cover of the reader by unlocking the sliders and take out the battery.



Note: For more information about back cover locking and opening, see [Changing Battery in the MX-1000 Reader](#).

2. Plug the pistol grip accessory cable into the grip accessory connector.

⚠ WARNING: Do not insert the battery into the pistol grip during the assembly process.

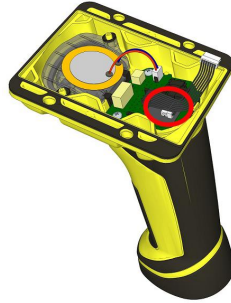

i Note: For more information on how to insert the battery into the grip after the assembly process, see [Changing Battery in the Pistol Grip on page 22](#)

3. Insert the cable to the cable connector in the battery bay.

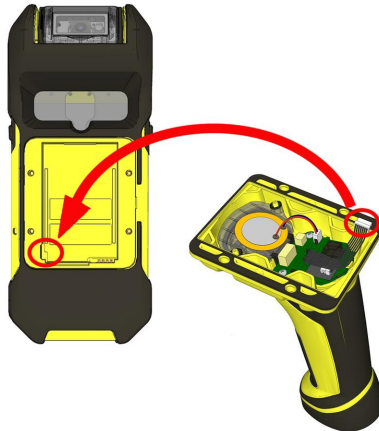

4. Insert the reader battery into the battery bay, and assemble the pistol grip and the reader by tightening the four Allen screws (recommended torque: 65 Ncm).

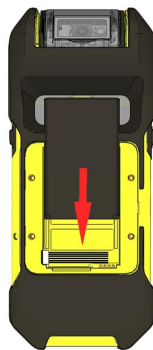

Charging

Charging an MX-1000 Using the Wireless Charging Station

You can charge your MX-1000 reader using the wireless charging station. It has threaded inserts at the bottom to be securely mountable on different surfaces. It allows the charging of both the spare battery and the main unit.

The charging station can charge the main battery, the spare battery, and - if attached - the pistol grip battery at the same time.

To fully charge the battery using the charging station is:

- 4 hours when charging the battery separately
- 10-11 hours when charging the phone, and the battery in the device with the pistol grip (with battery) attached
- 6 hours when charging the battery in the device and the phone
- 6 hours when charging the battery in the pistol grip attached to the device, but the main battery is not inserted

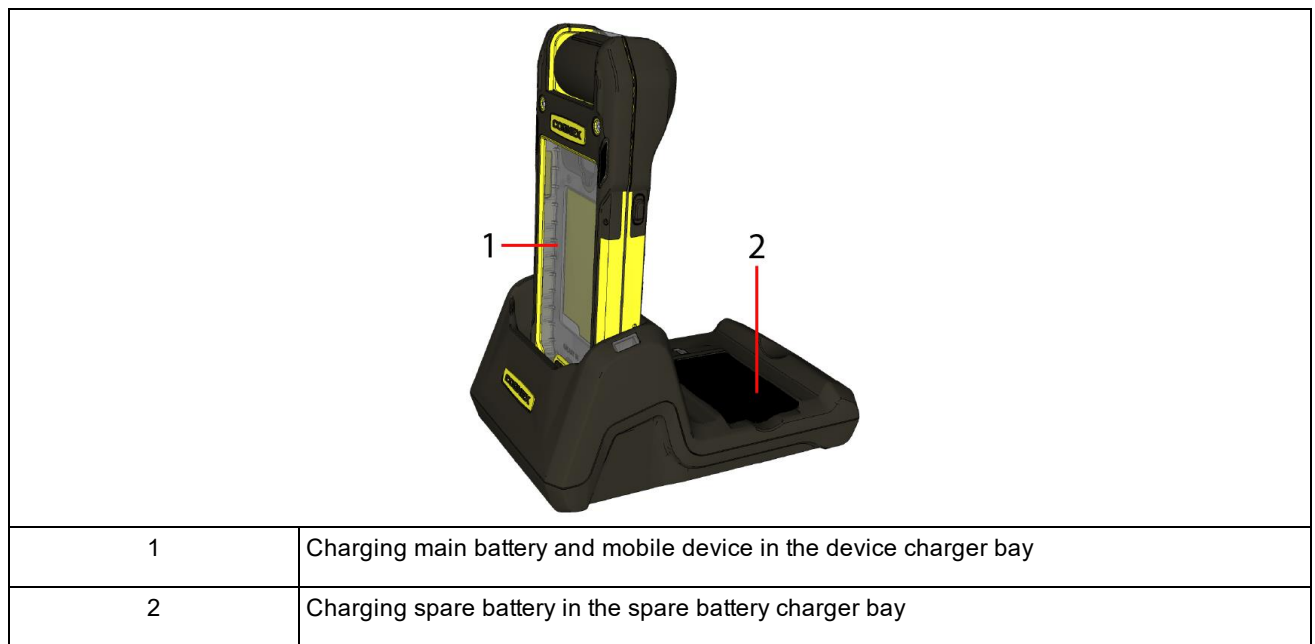

When you place your reader containing your mobile phone into the device bay of the charging station, the charging station power LED becomes green and the indicator LED of the reader becomes red (1). It indicates that the charger is active and the reader is charging. When the charging process is complete, the indicator of the reader LED turns green (2).

1)



2)



When the wireless reader is removed from the device bay, the charging station power led becomes red. It indicates that the charger is inactive.



To charge the spare battery, you need to insert it to the battery charging bay of the charging station. Make sure that the battery fits the battery bay properly.



Once you put the spare battery into the battery bay, the battery charger LED light turns to red, while the flashing red light indicates an error.



When charging is finished, the LED light turns green.



Note: For more information on the battery charger LED lights, see [Indicator LEDs on page 10](#)

USB Type-C Charging

You can also charge your MX-1000 reader using USB if you use a USB Type-C battery cover.

Tip: For optimum charging, do not power off your mobile device during the charging process.

1. Insert a 5V/3A Type-C USB cable into the slot in the battery cover, and the reader starts charging.

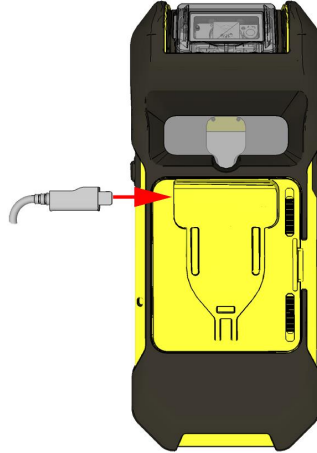

Note: Both the cable and the power supply must be compatible with 5V/3A.

Changing Battery in the MX-1000 Reader

The MX-1000 reader contains a battery (lithium polymer battery, capacity: 3000 mAh) which you can charge by putting it into the spare battery charging bay of the charging station.

To change the battery:

1. Open the battery cover of your reader by unlocking the two cover sliders and pulling the cover side.

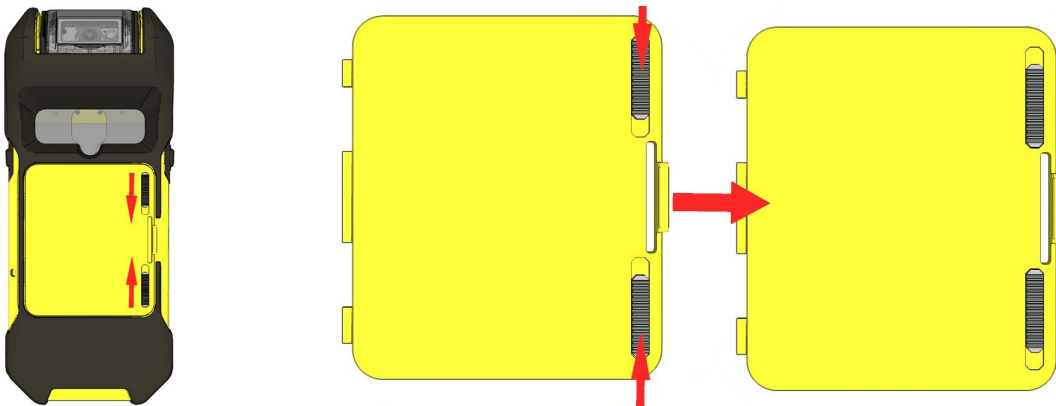

2. Take out the battery and charge it using the charging station.

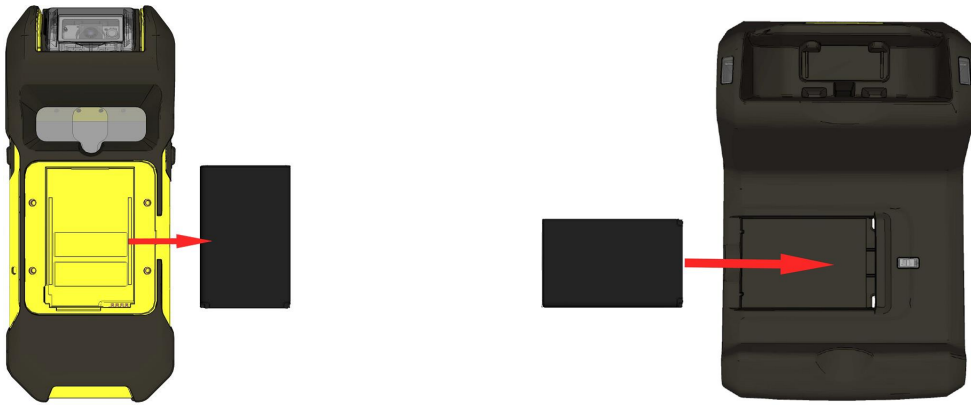

Note: For more information on charging the batteries, see [Charging](#).

- Put a new battery into the battery bay of your reader or wait until the charging process of the discharged battery is finished. Make sure that the battery is properly installed in the battery bay.

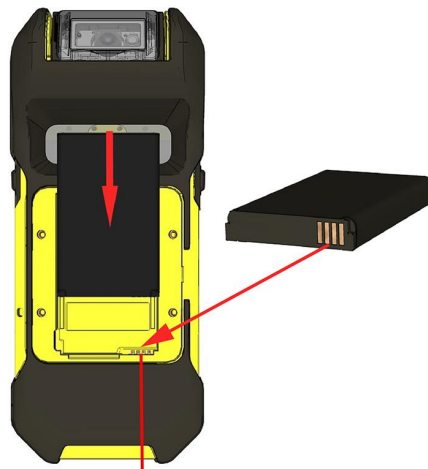

battery contacts

- Close the battery bay by locking the cover sliders.

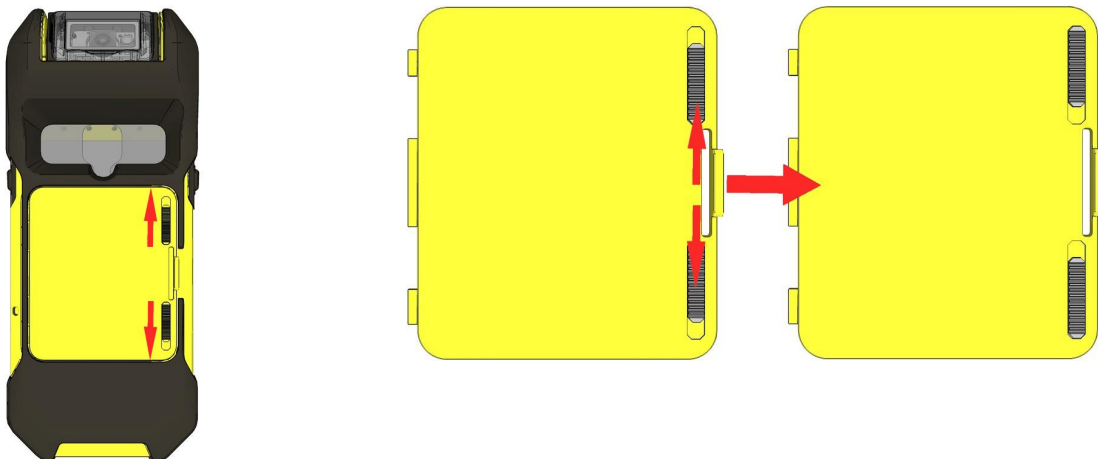

Changing Battery in the Pistol Grip

To change the battery in the pistol grip, perform the following steps:

1. Twist the end cap of the reader, and take it off.

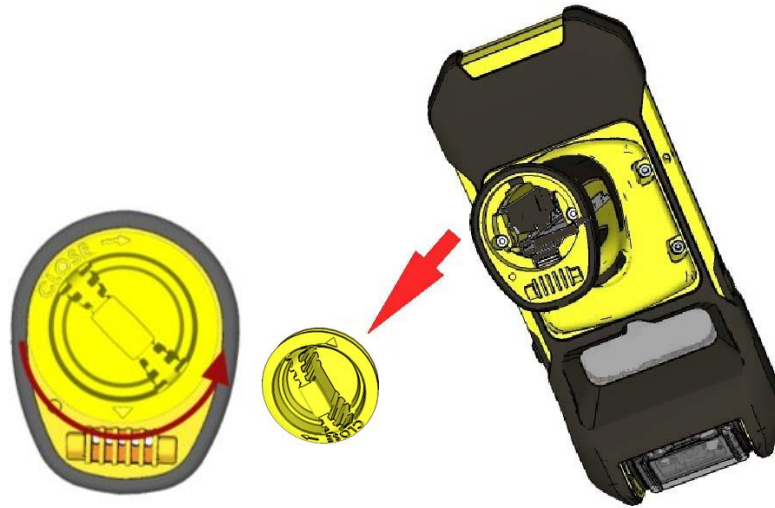

2. Hold the reader in an upright position, and the battery will slide out of the handle. You may need to shake the reader slightly.



CAUTION: The battery used in the devices may present a risk of fire or chemical burn if mistreated. Do not disassemble, heat above 60 °C (140 °F), or incinerate. Replace battery with Cognex DMA-HHBATTERY-01 only. The use of another battery may present a risk of fire or explosion.

- Put the replacement battery into the slot. The battery has a small triangle on one side. Make sure that you insert the battery into the slot with the side depicting the triangle pushed in first.

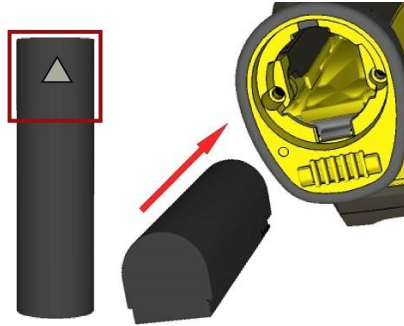

- Put the end cap back on and secure it by twisting it in the direction marked CLOSE. Make sure that the triangle aligns with the circle when the cover is locked.



Reading Codes with your MX-1000

The following map shows the field of view (FoV) of MX-1000 readers. Reading distance values are also provided for 2-D and Code39 example code distances.

Field of View and Reading Distances

There is a range of reading distances available for different code sizes.

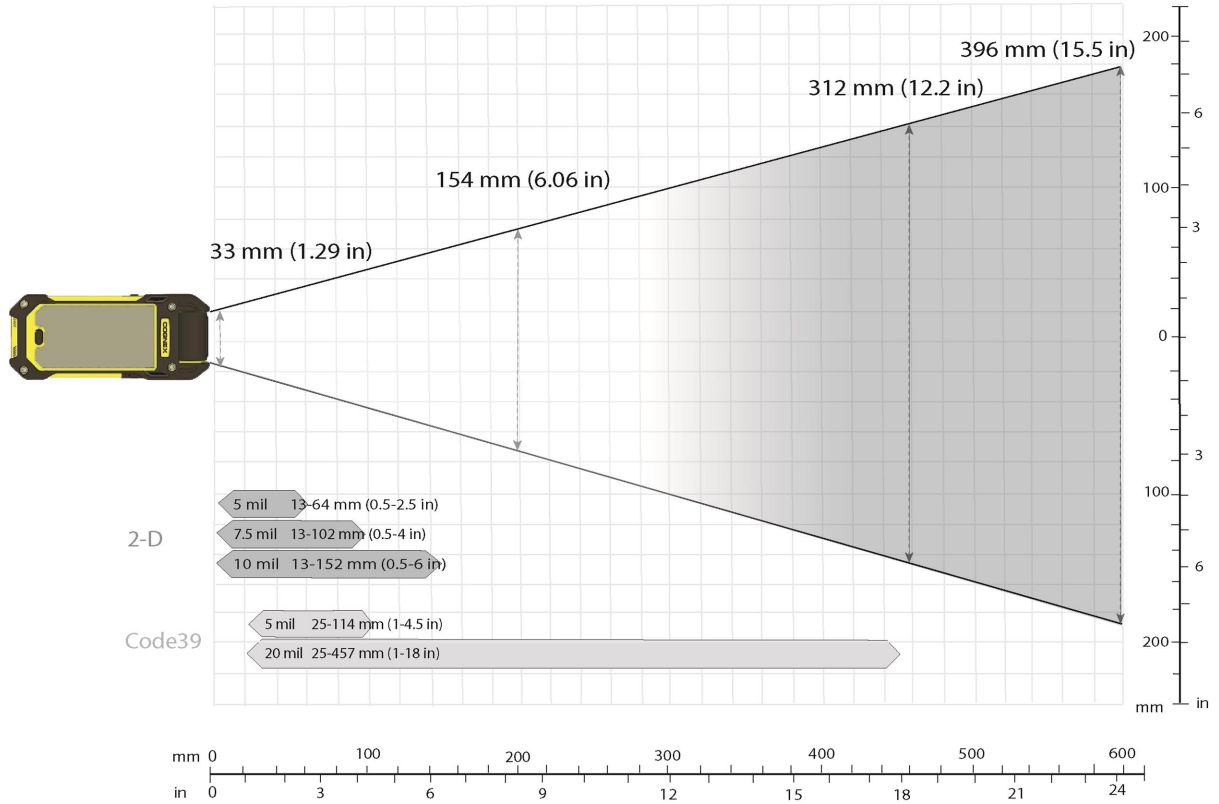

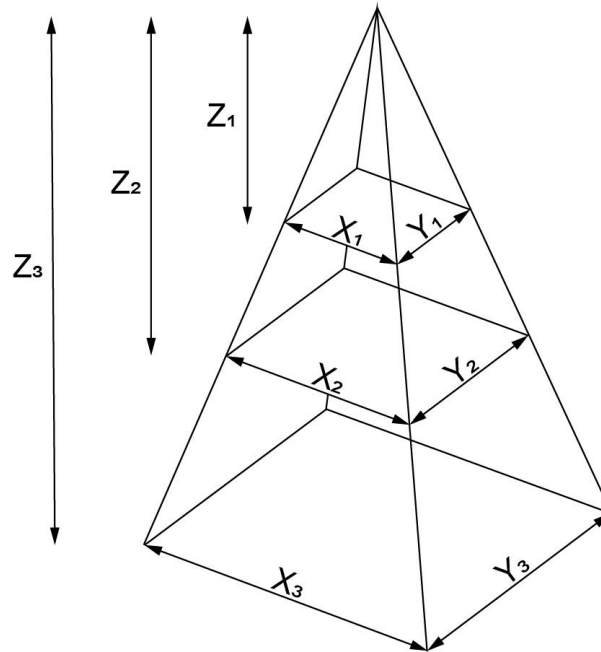

Working Distance	Horizontal Values	Vertical Values
$Z_1 = 15 \text{ mm}$	$X_1 = 6.4 \text{ mm}$	$Y_1 = 4.09 \text{ mm}$
$Z_2 = 210 \text{ mm}$	$X_2 = 148.31 \text{ mm}$	$Y_2 = 94.67 \text{ mm}$
$Z_3 = 420 \text{ mm}$	$X_3 = 301.14 \text{ mm}$	$Y_3 = 192.22 \text{ mm}$

Distances in mm / 1D min code		Distances in mm / 2D min code	
25-105	5 MIL	15-70	5 MIL
25-158	7.5 MIL	15-105	7.5 MIL
25-210	10 MIL	15-140	10 MIL
25-420	20 MIL	15-275	20 MIL

Note: Due to tolerances, ranges can vary by +/- 5 mm for small codes to +/- 2 centimeters for large codes.

Cleaning and Maintenance

Cleaning the Reader Housing

To clean the outside of the reader housing, use a small amount of mild detergent cleaner or isopropyl alcohol on a cleaning cloth. Do not pour the cleaner directly onto the reader housing.

 **CAUTION:** Do not attempt to clean any MX Series product with harsh or corrosive solvents, including lye, methyl ethyl ketone (MEK) or gasoline.

Cleaning the Reader Lens Cover

To remove dust from the lens cover, use a pressurized air duster. The air must be free of oil, moisture or other contaminants that could remain on the lens cover. To clean the plastic window of the lens cover, use a small amount of isopropyl alcohol on a cleaning cloth. Do not scratch the plastic window. Do not pour the alcohol directly on the plastic window.



Compliance Statements

The MX-1000 has Regulatory Model 1AA7 (inductive) and Regulatory Model R00078 (non-inductive) , and meets or exceeds the requirements of all applicable standards organizations for safe operation. However, as with any electrical equipment, the best way to ensure safe operation is to operate them according to the agency guidelines that follow. Please read these guidelines carefully before using your device.

The following specifications apply to the MX-1000 readers:

Regulator	Specification
USA	FCC 47 CFR Part 15, Subpart B Class A
Canada	ICES-003, Class A
European Community	EN55022, Class A EN55024
Australia	AS/NZS 3548 Class B
Korea	IEC/CISPR 22 IEC/CISPR 24 KN22 KN24 Registration number: MSIP-REM-CGX-DM9050

Note: For the most current CE declaration and regulatory conformity information, see the Cognex support site: cognex.com/support.

Safety and Regulatory	
European Compliance 	This is a class A product. In a domestic environment this product may cause radio interference in which case the user may be required to take adequate measures. This equipment complies with the essential requirements of EU Directive 2014/30/EU. Declarations are available from your local representative.
FCC Class A Compliance Statement 	This equipment has been tested and found to comply with the limits for a Class A digital device, pursuant to part 15 of the FCC Rules. These limits are designed to provide reasonable protection against harmful interference when the equipment is operated in a commercial environment. This equipment generates, uses, and can radiate radio frequency energy and, if not installed and used in accordance with the instruction manual, may cause harmful interference to radio communications. Operation of this equipment in a residential area is likely to cause harmful interference in which case the user will be required to correct the interference at his own expense.
Canadian Compliance	This Class A digital apparatus complies with Canadian ICES-003. Cet appareil numérique de la classe A est conforme à la norme NMB-003 du Canada.
Korea 	MX-1000: Regulatory Model 1AA7 (inductive), R00078 (non-inductive)

For European Union Users

Cognex complies with Directive 2012/19/EU OF THE EUROPEAN PARLIAMENT AND OF THE COUNCIL of 4 July 2012 on waste electrical and electronic equipment (WEEE).

This product has required the extraction and use of natural resources for its production. It may contain hazardous substances that could impact health and the environment, if not properly disposed.

In order to avoid the dissemination of those substances in our environment and to diminish the pressure on the natural resources, we encourage you to use the appropriate take-back systems for product disposal. Those systems will reuse or recycle most of the materials of the product you are disposing in a sound way.



The crossed out wheeled bin symbol informs you that the product should not be disposed of along with municipal waste and invites you to use the appropriate separate take-back systems for product disposal.

If you need more information on the collection, reuse, and recycling systems, please contact your local or regional waste administration.

You may also contact your supplier for more information on the environmental performance of this product.

Compliance Statements: MX-1000 Charging Station

The MX-1000 Charging Station has Regulatory Model 1ABA (inductive) and Regulatory Model R00080 (non-inductive), and meets or exceeds the requirements of all applicable standards organizations for safe operation. However, as with any electrical equipment, the best way to ensure safe operation is to operate them according to the agency guidelines that follow. Please read these guidelines carefully before using your device.

Regulator	Specification
USA	FCC 47 CFR Part 15, Subpart B Class A
Canada	ICES-003, Class A
European Community	EN55032, Class A EN55024
Australia	AS/NZS 3548 Class A
Japan	VCCI V-3/2015.04 Class A
Korea	IEC/CISPR 22 IEC/CISPR 24 KN22 KN24 Registration number: MSIP-REM-CGX-DMA-MT-BASE

For European Union Users

Cognex complies with Directive 2012/19/EU OF THE EUROPEAN PARLIAMENT AND OF THE COUNCIL of 4 July 2012 on waste electrical and electronic equipment (WEEE).

This product has required the extraction and use of natural resources for its production. It may contain hazardous substances that could impact health and the environment, if not properly disposed.

In order to avoid the dissemination of those substances in our environment and to diminish the pressure on the natural resources, we encourage you to use the appropriate take-back systems for product disposal. Those systems will reuse or recycle most of the materials of the product you are disposing in a sound way.



The crossed out wheeled bin symbol informs you that the product should not be disposed of along with municipal waste and invites you to use the appropriate separate take-back systems for product disposal.

If you need more information on the collection, reuse, and recycling systems, please contact your local or regional waste administration.

You may also contact your supplier for more information on the environmental performance of this product.

Safety and Regulatory	
European Compliance CE	This is a Class A product. In a domestic environment this product may cause radio interference in which case the user may be required to take adequate measures. This equipment complies with the essential requirements of EU Directive 2014/30/EU. Declarations are available from your local representative.

Safety and Regulatory	
FCC Class A Compliance Statement 	FCC Part 15, Class A This equipment has been tested and found to comply with the limits for a Class A digital device, pursuant to part 15 of the FCC Rules. These limits are designed to provide reasonable protection against harmful interference when the equipment is operated in a commercial environment. This equipment generates, uses, and can radiate radio frequency energy and, if not installed and used in accordance with the instruction manual, may cause harmful interference to radio communications. Operation of this equipment in a residential area is likely to cause harmful interference in which case the user will be required to correct the interference at his own expense.
Canadian Compliance	This Class A digital apparatus complies with Canadian ICES-003. Cet appareil numérique de la classe A est conforme à la norme NMB-003 du Canada.

中国大陆RoHS (Information for China RoHS Compliance)

根据中国大陆《电子信息产品污染控制管理办法》(也称为中国大陆RoHS), 以下部份列出了本产品中可能包含的有毒有害物质或元素的名称和含量。



Table of toxic and hazardous substances/elements and their content, as required by China's management methods for controlling pollution by electronic information products.

Part Name 部件名称	Hazardous Substances 有害物质					
	Lead (Pb) 铅	Mercury (Hg) 汞	Cadmium (Cd) 镉	Hexavalent Chromium (Cr (VI)) 六价铬	Polybrominated biphenyls (PBB) 多溴联苯	Polybrominated diphenyl ethers (PBDE) 多溴二苯醚
Regulatory Model 1AA7 Regulatory Model 1ABA	X	O	O	O	O	O

This table is prepared in accordance with the provisions of SJ/T 11364.
这个标签是根据SJ/T 11364 的规定准备的。

O: Indicates that said hazardous substance contained in all of the homogeneous materials for this part is below the limit requirement of GB / T26572 - 2011.
表示本部件所有均质材料中含有的有害物质低于GB / T26572 - 2011 的限量要求。

X: Indicates that said hazardous substance contained in at least one of the homogeneous materials used for this part is above the limit requirement of GB / T26572 - 2011.
表示用于本部件的至少一种均质材料中所含的危害物质超过GB / T26572 - 2011 的限制要求。

Precautions

To reduce the risk of injury or equipment damage, observe the following precautions when you install the Cognex product:

- Route cables and wires away from high-current wiring or high-voltage power sources to reduce the risk of damage or malfunction from the following causes: over-voltage, line noise, electrostatic discharge (ESD), power surges, or other irregularities in the power supply.
- Changes or modifications not expressly approved by the party responsible for regulatory compliance could void the user's authority to operate the equipment.
- Ensure that the cable bend radius begins at least six inches from the connector. Cable shielding can be degraded or cables can be damaged or wear out faster if a service loop or bend radius is tighter than 10X the cable diameter.
- This device should be used in accordance with the instructions in this manual.
- All specifications are for reference purposes only and can change without notice.

