

DataMan[®] 475 Verifier Reference Manual

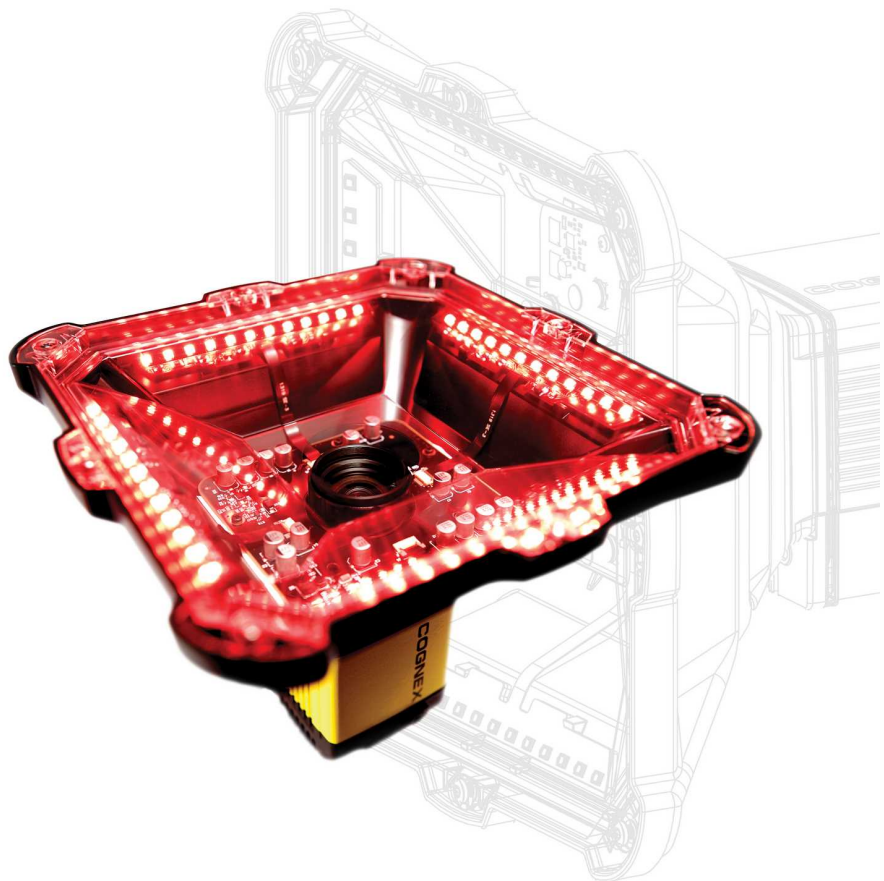

2021 February 24
Revision: 6.2.1.1

Legal Notices

The software described in this document is furnished under license, and may be used or copied only in accordance with the terms of such license and with the inclusion of the copyright notice shown on this page. Neither the software, this document, nor any copies thereof may be provided to, or otherwise made available to, anyone other than the licensee. Title to, and ownership of, this software remains with Cognex Corporation or its licensor. Cognex Corporation assumes no responsibility for the use or reliability of its software on equipment that is not supplied by Cognex Corporation. Cognex Corporation makes no warranties, either express or implied, regarding the described software, its merchantability, non-infringement or its fitness for any particular purpose.

The information in this document is subject to change without notice and should not be construed as a commitment by Cognex Corporation. Cognex Corporation is not responsible for any errors that may be present in either this document or the associated software.

Companies, names, and data used in examples herein are fictitious unless otherwise noted. No part of this document may be reproduced or transmitted in any form or by any means, electronic or mechanical, for any purpose, nor transferred to any other media or language without the written permission of Cognex Corporation.

Copyright © 2020. Cognex Corporation. All Rights Reserved.

Portions of the hardware and software provided by Cognex may be covered by one or more U.S. and foreign patents, as well as pending U.S. and foreign patents listed on the Cognex web site at: cognex.com/patents.

The following are registered trademarks of Cognex Corporation:

Cognex, 2DMAX, Advantage, AlignPlus, Assemblyplus, Check it with Checker, Checker, Cognex Vision for Industry, Cognex VSOC, CVL, DataMan, DisplayInspect, DVT, EasyBuilder, Hotbars, IDMax, In-Sight, Laser Killer, MVS-8000, OmniView, PatFind, PatFlex, PatInspect, PatMax, PatQuick, SensorView, SmartView, SmartAdvisor, SmartLearn, UltraLight, Vision Solutions, VisionPro, VisionView

The following are trademarks of Cognex Corporation:

The Cognex logo, 1DMax, 3D-Locate, 3DMax, BGAll, CheckPoint, Cognex VSoC, CVC-1000, FFD, iLearn, In-Sight (design insignia with cross-hairs), In-Sight 2000, InspectEdge, Inspection Designer, MVS, NotchMax, OCRMax, PatMax RedLine, ProofRead, SmartSync, ProfilePlus, SmartDisplay, SmartSystem, SMD4, VisiFlex, Xpand

Portions copyright © Microsoft Corporation. All rights reserved.

Portions copyright © MadCap Software, Inc. All rights reserved.

Other product and company trademarks identified herein are the trademarks of their respective owners.

Table of Contents

Legal Notices	2
Table of Contents	3
Symbols	5
Getting Started	6
About the DataMan 475 Verifier	6
Configuration	6
DataMan 475 Verifier Accessories	8
Cables and Power Supply	8
Mounting Brackets	8
DataMan 470 Systems	9
Setting Up Your DataMan 475 Verifier	10
Reader Layout	10
Dimensions	12
DataMan 475 Verifier	12
Additional Information	13
DataMan 475 Verifier Specifications	13
DataMan 475 Series Verifier Imager Specifications	13
LED Wavelengths	14
Calibration	14
User Interface	17
Toolbar	17
Using Your DataMan 475 Verifier	18
Verifying a 2D Barcode	18
Selecting Regions	19
Standards Based Grading	20
Verifications of Multiple Symbols	20
Examining the Results	22
1D & 2D Verification	22
Main Tab	22
General Characteristics Tab	23
Data Detail Tab	24
Quality Detail Tab	25
Advanced Detail Tab	26
Histogram Tab	26
Report Tab	27
Settings	29
Accessing the Settings Menu	29
Application Settings	29
Application Standards Settings	29
Grading Standards	34
Data Format Check	34
Scripting	37

Grading Standards and their Parameters	39
ISO/IEC 15415 Grading Parameters	39
ISO 29158 (AIM-DPM) 2006 Grading Parameters	43
Traditional (Non-Graded) Parameters	44
PCS	44
MRD	45
ISO/IEC 15416 (ANSI x3.182) Grading Parameters	45
Using Your DataMan 475 Verifier	48
Reading your first Code	48
External Triggers	50
Cleaning and Maintenance	51
Cleaning the Verifier Housing	51
Cleaning the Verifier Lens Cover	51
Compliance Information, Warnings and Notices	52
Precautions	52
Regulations/Conformity	53
For European Community Users	53
Reader Programming Codes	54

Symbols

The following symbols indicate safety precautions and supplemental information:

 **WARNING:** This symbol indicates a hazard that could cause death, serious personal injury or electrical shock.

 **CAUTION:** This symbol indicates a hazard that could result in property damage.

 **Note:** This symbol indicates additional information about a subject.

 **Tip:** This symbol indicates suggestions and shortcuts that might not otherwise be apparent.

Getting Started

This section provides general information about the DataMan 475 and the DataMan 475 accessories and systems.

About the DataMan 475 Verifier



The DataMan 475 verifier provides several immediate quality assurance benefits:

- Sets alerts for when code quality begins to degrade
- Grades up to 20 codes per second
- Exports verification results to PLC, database, or FTP server, as CSV, HTML, PDF, or custom formats
- Improves processes with detailed analysis and diagnostic information for every code

The DataMan 475 four-quadrant, 45-degree lighting attachment is compliant with the International Organization for Standardization (ISO) requirements for grading 1D and 2D label-based barcodes. The included calibration card and robust grading algorithms ensure that the DataMan 475 conforms to ISO and application standards while providing accurate and repeatable results.

The DataMan 475 verifiers are packaged in a rugged, IP65-rated housing, and provide numerous ease-of-use features, including one button to trigger and one to start tuning.

Configuration

This document provides basic information about how to configure and use the DataMan 475 verifier. Additional information is available through the Windows **Start** menu or the DataMan Setup Tool **Help** menu once installing the DataMan software on your PC:

- The ***DataMan Communications and Programming Guide*** shows you how to integrate your DataMan reader into your particular automation and factory environment.

Cognex->DataMan Software v x.x.x->Documentation->Communications->DataMan Communications and Programming Guide

- The ***DataMan Industrial Protocols Manual*** provides information on how to integrate DataMan readers into your particular environment using industrial protocols.







Cognex->DataMan Software v x.x.x->Documentation->Communications->DataMan Industrial Protocols Manual

- The **DataMan Reader Configuration Codes** document provides printable 2-D codes that you can use to configure the DataMan reader.
Cognex->DataMan Software v x.x.x->Documentation->English->Reader Configuration Codes
- The **DataMan 475 Verifier Quick Reference Guide** provides essential information about the DataMan 475 Verifier.
Cognex->DataMan Software v x.x.x->Documentation->English->DM475V Series->DM475V Quick Reference Guide
- The **DataMan Fixed-Mount Readers Reference** is a complete online hardware reference for the DataMan fixed-mount ID readers.
Cognex->DataMan Software v x.x.x->Documentation->English->DM475V ->Fixed-Mount Reference Manual
- The **DataMan Questions and Answers** document provides context-sensitive information. You can view this help inside the DataMan Setup Tool or as a stand-alone help file.
Cognex->DataMan Software v x.x.x->Documentation->DM475V->Questions and Answers
- The **DataMan Control Commands** lists DataMan Control Commands with all relevant information. You can view this help inside the Setup Tool or as a stand-alone help file.
Cognex->DataMan Software v x.x.x->Documentation->English->DataMan Control Commands
- The **Setup Tool Reference Manual** describes the user interface of the DataMan Setup Tool software.
Cognex->DataMan Software v x.x.x->Documentation->English->Setup Tool Reference Manual
- The **Release Notes** list detailed system requirements and additional information about this DataMan software release.
Cognex->DataMan Software v x.x.x->Documentation->DataMan v x.x.x Release Notes



DataMan 475 Verifier Accessories

ISO compliant verification requires the DM475V with LabelLight 45° lighting accessory for verification configured as a DMV-475V-LBL. Accessories on the DM475V can be used for standards based grading only.

Cables and Power Supply

Accessory		
Power and I/O breakout cable, M12-12, straight, xx specifies length: 5 m, 10 m, 15 m, angled, xx specifies length: 5 m, 10 m, 15 m	CCB-PWRIO-xx CCB-PWRIO-xxR	
X-Coded to A-Coded Ethernet cable adapter, 0.5 m	CCB-M12X8MS-XCAC	
X-Coded to RJ45 Ethernet cable, xx specifies length: 2 m, 5 m, 15 m, 30 m	CCB-84901-2001-xx	
I/O extension cable, 5 m straight	CKR-200-CBL-EXT	
Connection module (up to 4 cameras including network switch) (xx can be US, EU, UK or JP)	DMA-CCM-4X-xx	
Connection module (1 camera) (xx can be US, EU, UK or JP)	DMA-CCM-1-xx	

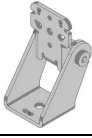
Mounting Brackets

Accessory		
Mounting Bracket Kit	DMBK-470-MNT	
Pivot Mounting Bracket	DM100-PIVOTM-00	
External Heat Sink	DMHS-370-470	

DataMan 470 Systems

	Symbologies	Light Configurations	Verification Standards
DMV-475V-LBL-0200	1D, 2D, DPM	45° LabelLight	ISO/IEC 15415, 15416, 29158

Setting Up Your DataMan 475 Verifier

This section provides information on the physical appearance of the DataMan 475 verifier. It also details the steps of installing the lenses and filters of the verifier, and gives information on the imager itself.

Reader Layout

The following image shows the built-in lighting system of the DataMan 475 verifier, and the mounting holes underneath the plastic lighting cover.

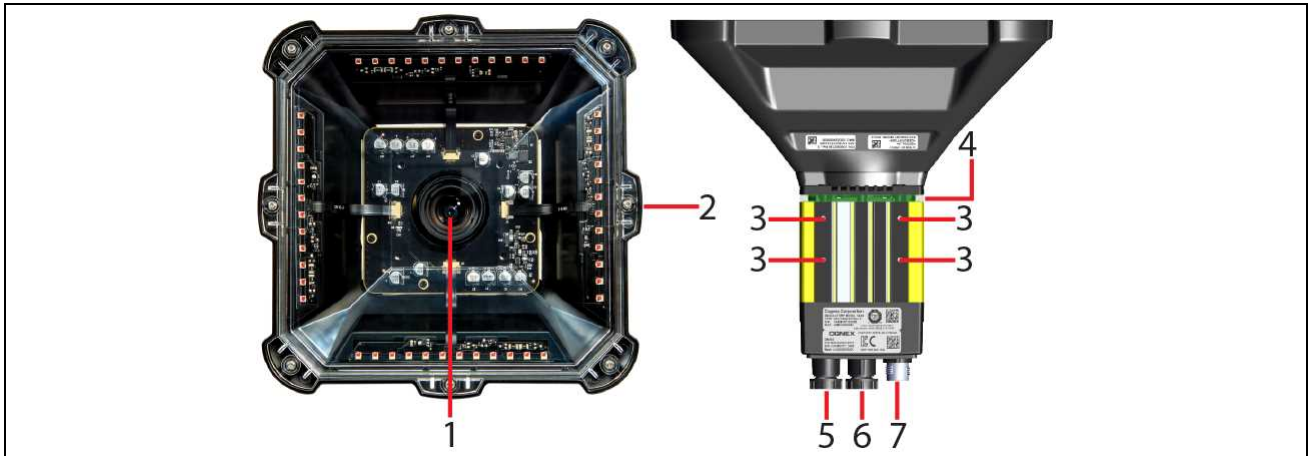

1	Lens
2	Label Light attachment
3	Mounting holes (M3 x 5 mm)
4	Indicator light ring
5	Ethernet connection
6	External lighting connection (disabled for verification)
7	Breakout cable connection

The following image shows a detailed picture about the back cover and the functions of the indicator lights.

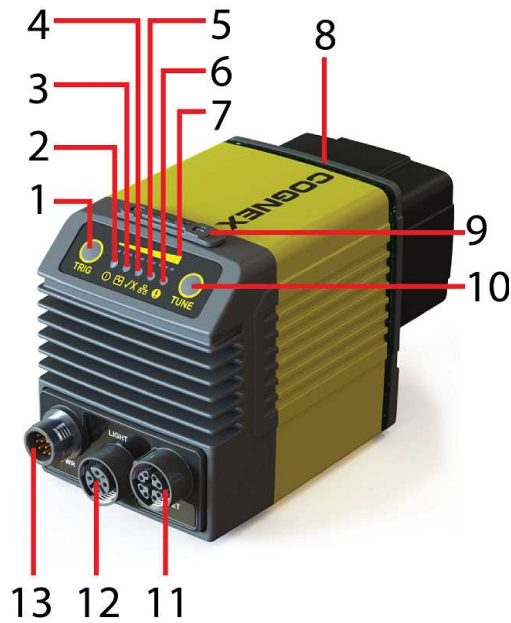

1	Trigger button
2	Power
3	Train status
4	Good/bad read
5	Network
6	Error
7	Peak meter
8	Indicator light ring
9	SD card slot
10	Tuning button
11	Ethernet
12	External light control
13	Power, I/O, and RS-232

Type	Signal	Color	Meaning
Status	Power	GREEN	Power ON
	Train status	GREEN	Trained
		YELLOW	Untrained
	Error	RED	Error - check device log
Action	Good/bad read	GREEN	Good read
		RED	Bad read
	Communication	YELLOW	Link up
		<i>blink</i>	Activity
Peak meter	-	Decode yield, train progress/quality	

Dimensions

Note:



- Dimensions are in millimeters [inches] and are for reference purposes only.
- All specifications are for reference purposes only and can change without notice.

Observe the following DataMan 475 verifier dimensions when installing your reader.

DataMan 475 Verifier

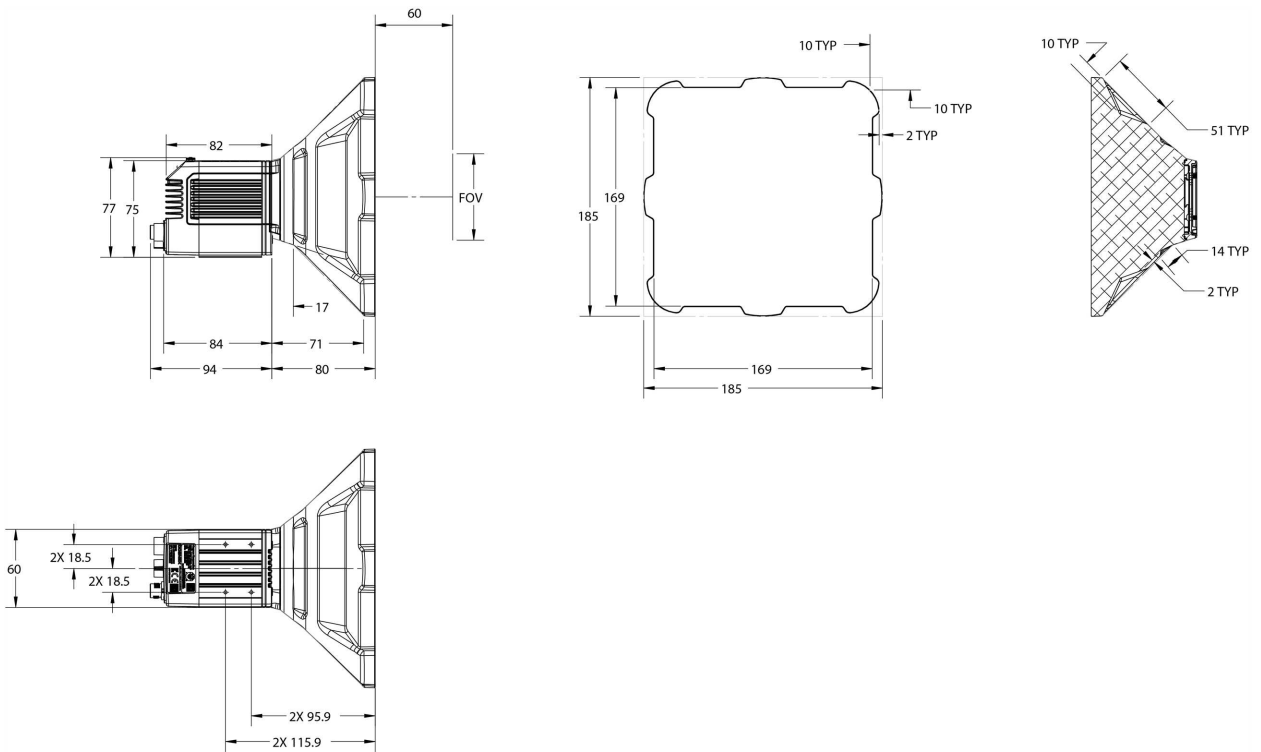

Additional Information

DataMan 475 Verifier Specifications

Specification	DataMan 475 Verifier																								
Weight	945 g																								
Field of View	80 x 60 mm																								
Dimensions	185 x 185 x 175 mm																								
Power Consumption	<ul style="list-style-type: none"> 24 VDC \pm10%, 1.5 A maximum (Label Light, 36 W peak power consumption) Supplied by LPS or NEC class 2 only.																								
Light Connector	0.4 A <div style="border: 1px solid black; padding: 2px; margin-top: 5px;"> Note: The Light Connector is disabled while the Label Light accessory is in place. </div>																								
Case Temperature ¹	0 °C - 57 °C (32 °F - 134.6 °F)																								
Operating Temperature ²	0 °C - 40 °C (32 °F - 104 °F)																								
Storage Temperature	-20 °C - 80 °C (-4 °F - 176 °F)																								
Humidity	< 95% non-condensing																								
Environmental	IP65 with cables and appropriate lens cover attached.																								
Shock (Shipping and Storage)	IEC 60068-2-27: 18 shocks (3 shocks in each polarity in each (X, Y, Z) axis) 80 Gs (800 m/s ² at 11 ms, half-sinusoidal) with cables or cable plugs and appropriate lens cover attached.																								
Vibration (Shipping and Storage)	IEC 60068-2-6: vibration test in each of the three main axis for 2 hours @ 10 Gs (10 to 500 Hz at 100 m/s ² / 15 mm) with cables or cable plugs and appropriate lens cover attached.																								
Supported Symbologies	1D codes: Codabar, Code 39, Code 128, and Code 93, Interleaved 2 of 5, UPC/EAN/JAN 2D codes: Data Matrix (ECC 200), QR Code, microQR Code																								
Discrete I/O operating limits	<table style="width: 100%; border-collapse: collapse;"> <tbody> <tr> <td style="width: 30%;">HS Output 0,1,2,3</td> <td style="width: 30%;">I_{MAX}</td> <td style="width: 30%;"></td> <td style="width: 10%; text-align: right;">50 mA</td> </tr> <tr> <td></td> <td>R_{MIN}</td> <td>@ 12 VDC</td> <td style="text-align: right;">200 Ω</td> </tr> <tr> <td>Input 0 (Trigger)</td> <td>V_{IH}</td> <td>$\pm 15 - \pm 28$ V</td> <td></td> </tr> <tr> <td>Input 1,2,3</td> <td>V_{IL}</td> <td>0 — ± 5 V</td> <td></td> </tr> <tr> <td></td> <td>I_{TYP}</td> <td>@ 12 VDC</td> <td style="text-align: right;">2.0 mA</td> </tr> <tr> <td></td> <td></td> <td>@ 24 VDC</td> <td style="text-align: right;">4.2 mA</td> </tr> </tbody> </table>	HS Output 0,1,2,3	I_{MAX}		50 mA		R_{MIN}	@ 12 VDC	200 Ω	Input 0 (Trigger)	V_{IH}	$\pm 15 - \pm 28$ V		Input 1,2,3	V_{IL}	0 — ± 5 V			I_{TYP}	@ 12 VDC	2.0 mA			@ 24 VDC	4.2 mA
HS Output 0,1,2,3	I_{MAX}		50 mA																						
	R_{MIN}	@ 12 VDC	200 Ω																						
Input 0 (Trigger)	V_{IH}	$\pm 15 - \pm 28$ V																							
Input 1,2,3	V_{IL}	0 — ± 5 V																							
	I_{TYP}	@ 12 VDC	2.0 mA																						
		@ 24 VDC	4.2 mA																						
Ethernet Speed	10/100/1000																								

DataMan 475 Series Verifier Imager Specifications

Specification	DataMan 475 Imager
Image Sensor	2/3 inch CMOS, global shutter

¹ Additional cooling measures may be required to keep the case temperature from exceeding 50 °C. Examples of such measures include: extra heat sinking and/or air movement.

² In situations where the operating temperature exceeds 40 °C, an external heat sink is required.

Specification	DataMan 475 Imager
Image Sensor Properties	8.8 mm x 6.6 mm (H x V); 3.45 µm square pixels
Image Resolution (pixels)	2448 x 2048
Electronic Shutter Speed	Fixed at 30 µs for ISO 15415 compliance. Auto adjusted exposure for ISO 29158 (AIM-DPM) compliance. If the user adjusts, there is no guarantee that the verifier retains compliance.
Image Acquisition at Full Resolution	37 Hz for imager without lighting. Max. acquisition speed with 45 lighting degree accessory enabled is significantly less. Practical acquisition rate is application dependent.

*Limitations to C-Mount lenses:

- The length of the thread may not exceed 5.4 mm.
- For a chosen lens, the distance from the C-mount shoulder to the bottom of the lens may not exceed 5.4 mm. Possibly, a lens spacer is required.
- When using the C-Mount lens cover, lens dimensions including spacer and filters may not exceed 32 x 42 mm (diameter x length).

LED Wavelengths

The following table shows LED types and the related peak wavelengths:

LED	λ [nm]
RED	660

Calibration

Calibration informs the verifier about the grey scale levels and pixel dimensions of the camera. This way, the verifier can report Symbol Contrast and X-dimension in true physical units.

For ISO compliant barcode verification, the verifier must be in a calibrated state.

For Standards Based Grading, the verifier can be used without calibration but not all quality parameters are reported. When the verifier is used in an uncalibrated state, neither the aperture nor Symbol Contrast (SC) for ISO/IEC 15415/15416 applications and Minimum Reflectance (MR) for ISO/IEC TR29158 (AIM-DPM) applications is reported.

Note: If the verifier is used in an uncalibrated state, the default aperture selection is Auto 80% but no aperture value is reported.

To calibrate the DataMan 475:

1. Click the Calibration icon in the top left corner in the TruCheck Verification window.



2. Enter the **Rmax** and **Rmin** values from the calibration card.

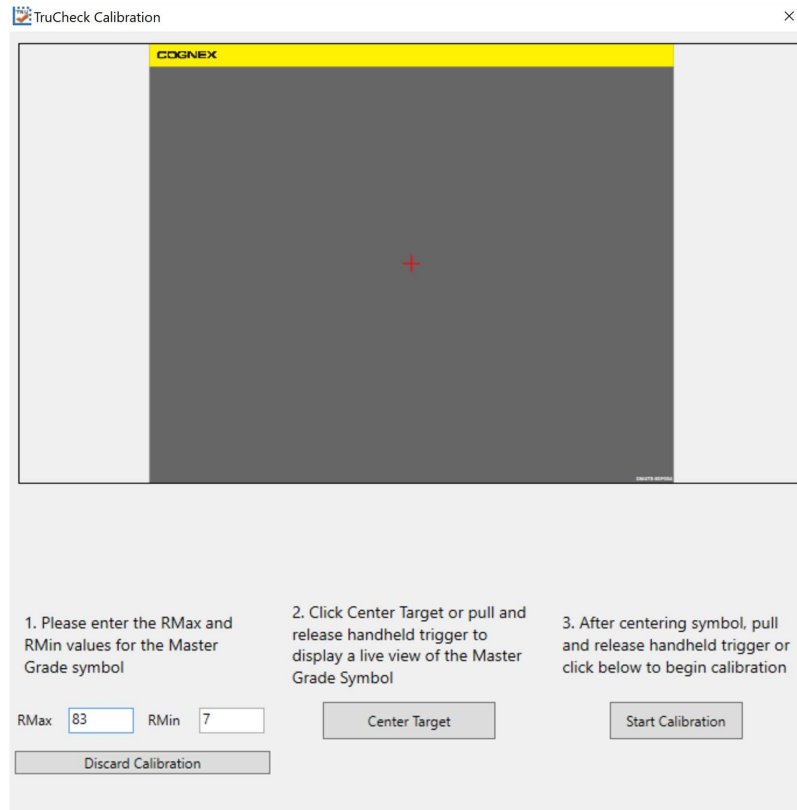

3. Select the **Center Target** button. A live image appears in the Calibration screen. Center the verifier over the Master Symbol on the Data Matrix symbol of your traceable calibration card.
4. Once the symbol is centered in the field of view, select **Start Calibration**.

- The verifier goes through a series of lighting calibrations. After a successful calibration, the **Calibration Complete** window pops up:

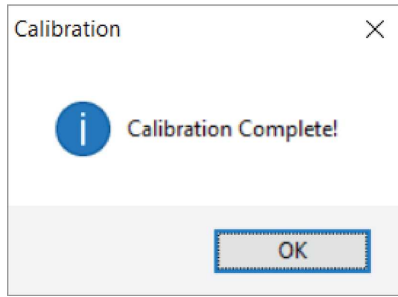

Tip: Use the **Discard Calibration** button to remove all calibration values and return the verifier to an uncalibrated state.

It is recommended to calibrate your verifier as needed to ensure accurate verification results. If the verifier is being used in a laboratory or QA environment, free of dust, vibration, bright sunlight or oil particulates, monthly calibration is appropriate. In production environments, where such contaminants exist, more frequent, for example weekly calibration is recommended. Any internal quality guidelines or protocols are to override recommendations about calibration.

Note: Ensure that the calibration card is stored away from direct light in a manner where contaminants do not compromise the calibration symbol.



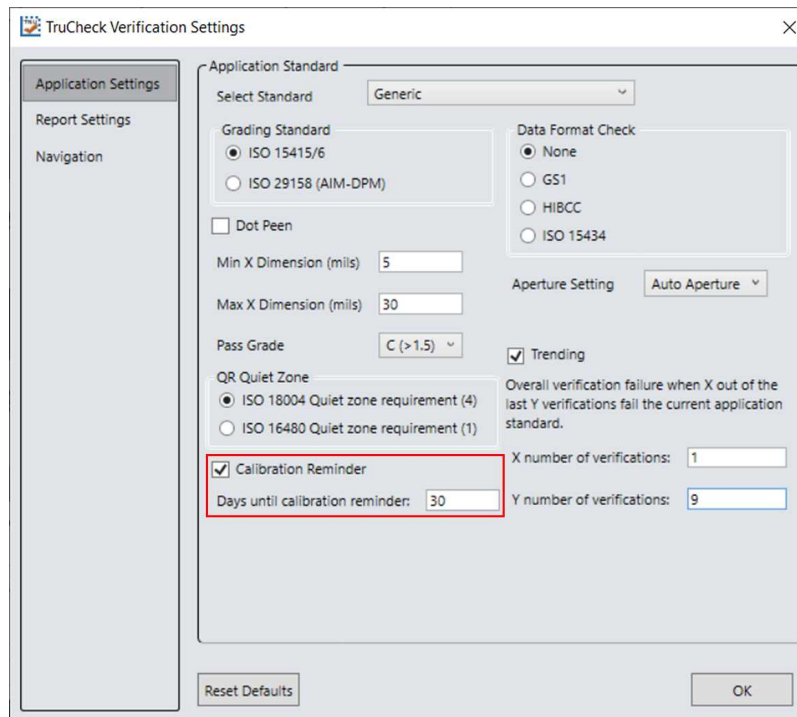

Tip: Enable an optional calibration reminder to alert when a calibration is due. When the calibration reminder is enabled, set the number of days for prompting a calibration reminder.



User Interface

This section describes the settings and options of the TruCheck Verification window.

Toolbar

Icon	Function
	<p>Settings: Opens up the settings menu allowing changes to be made to the Application Settings, the Reporting Settings and the User Information menu. For more information, see Settings on page 29.</p>
	<p>Calibration: Opens up the calibration window so that the unit can be calibrated. For more information, see Calibration on page 14.</p>
	<p>Grid & Modulation Circles: When selected, this applies a grid and/or modulation circles to the image after verification. By using the drop down menu options, you can apply a Real Grid, an Ideal Grid, or both. In addition, you can select to either show Mod Circles Filled or Mod Circles Outlined. When this icon is unselected, neither Grid nor Mod Circles is shown in the image.</p>
	<p>Original Image: Shows the original image used for verification.</p>
	<p>45° illumination: Selects 45° illumination. 45° four-sided illumination is used primarily for labels. This illumination is either not reported or is reported as 45Q. (If illumination is not reported, it is assumed to be 45Q).</p>

Using Your DataMan 475 Verifier

Verifying a 2D Barcode

To verify a Data Matrix code or a QR code in the TruCheck Verification Window:

1. Navigate to the **Main** tab.
2. Select **Go Live** and center your symbol in the field of view, or press and release the trigger button to **Go Live**.

Note: After selecting **Go Live**, the button changes to **Verify**.

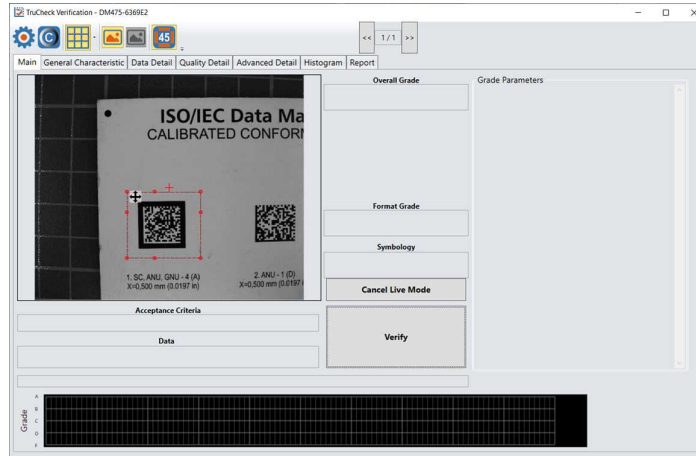

3. If necessary, draw a selection region around the code to be verified, if necessary.

Note: The region must be drawn around the outside perimeter of the code including quiet zones. More information on properly defining regions is explained in [Selecting Regions on page 19](#).

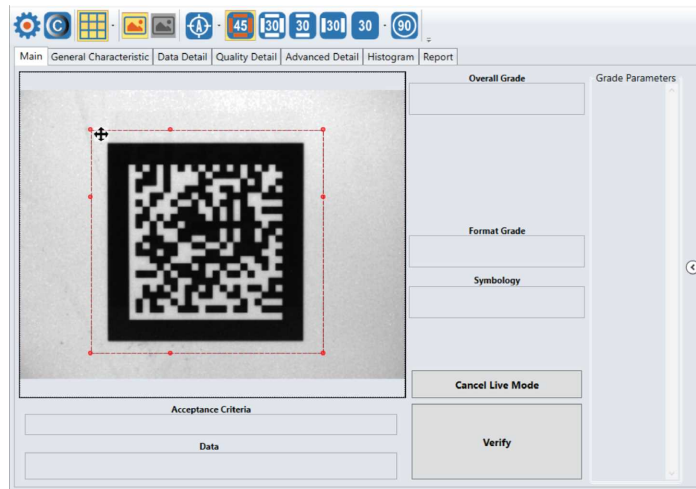

4. Select **Verify**, or press and release the trigger button on the verifier to begin verification.

Note: The following screenshot shows a successful 2D barcode verification. Depending on grading and application standards, additional details are displayed.

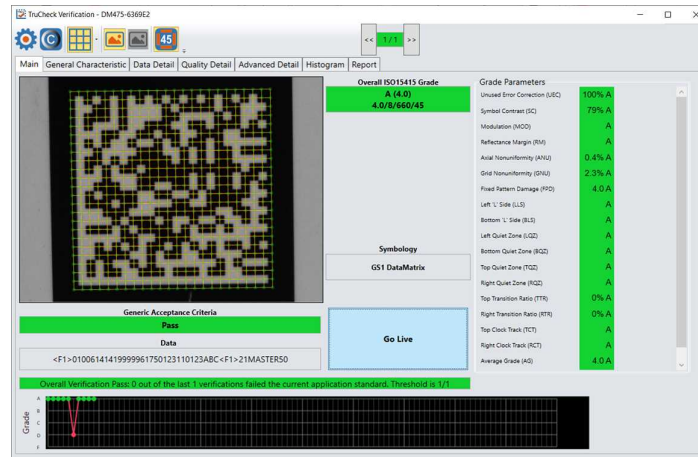

Note: The tool bar buttons and tabs shown on the screen are useful for in-depth analysis of codes. For more information, see [Examining the Results on page 22](#).

Selecting Regions

Specifying regions in the live image may be required for the following reasons:

- The code is off center.
- To speed up the verification process on verifiers with large fields of view. Defining a small sampling area increases the speed.
- To restrict a region used to adjust the image brightness when grading according to AIM-DPM (ISO/IEC 29158).
- To specify a barcode for verification when more than one barcode is present in the field of view.

If you do not define a region, the whole image is used.

To define a region:

1. Position your cursor where you want the region to start, hold the left mouse button down and begin drawing a box by moving the mouse.
2. Release the button when you are done.

For Data Matrix symbols and QR Codes, draw the region surrounding the code. The verifier needs the entire finder pattern, including quiet zones, within the selection to properly grade the code.

When verifying a 1D symbol, a region must be selected that includes the full width of the barcode including both quiet zones:

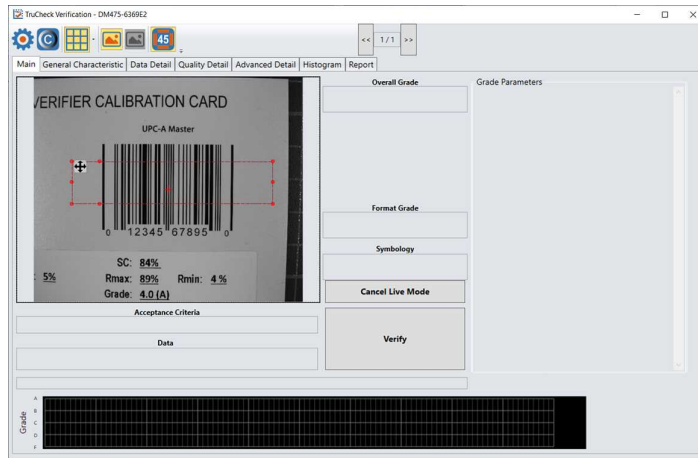

Standards Based Grading

Standards based grading is an option in the DM475V that uses true verification algorithms to produce well-defined, consistent results from the image of a code captured by a barcode reader in a real-world setup. In practice, the setup needs to be as close as possible to a real verifier – lighting angle in particular. The measurements are calculated the same way as with a verifier, so the closer the setup is to a true verifier, the closer the results are to true verification. With the same lighting setup, the measurements between standards based grading and verification converge. This method is called standards based grading because as the quality of a code changes during a production run, grades change in about the same way as with a verifier. Standards based grading is the closest way to achieve verification results without having to conform to specific lighting angles, distances, or every ISO standard parameter.

For Standards Based Grading, the verifier can be used without calibration but not all quality parameters are reported. When the verifier is used in an uncalibrated state, neither the aperture nor Symbol Contrast (SC) for ISO/IEC 15415/15416 applications and Minimum Reflectance (MR) for ISO/IEC TR29158 (AIM-DPM) applications is reported.

Note: If the verifier is used in an uncalibrated state, the default aperture selection is Auto 80% but no aperture value is reported.

Verifications of Multiple Symbols

The DM475V verifier can verify multiple barcodes simultaneously. To enable this feature, settings need to be made in Setup Tool before a verification is initiated in the TruCheck verification window.

1. Select **Code Details** in Setup Tool.
2. Under the Basic tab, change the **Number of Codes** field to a value greater than 1 to see the expanded list of options available.

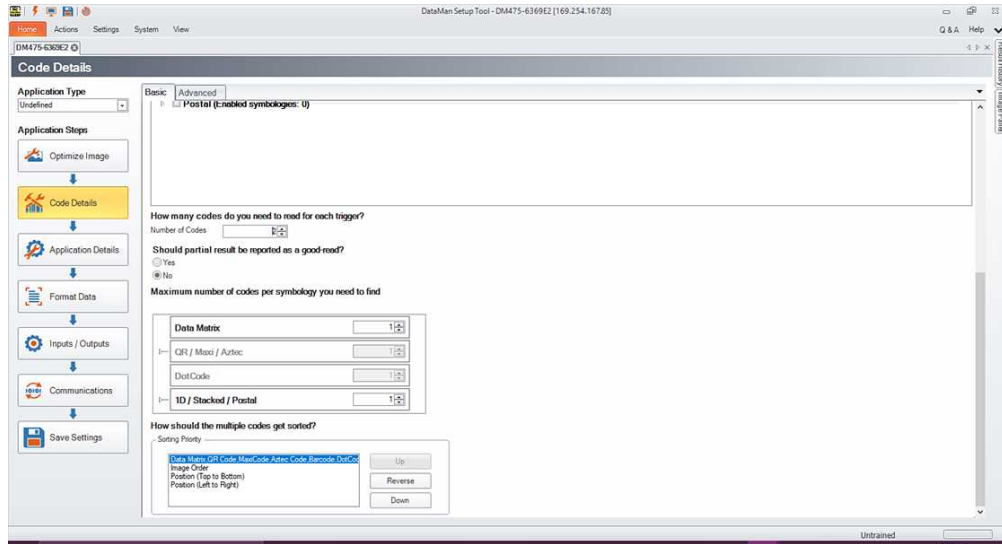

3. Select the **Number of Codes** to be verified during a single trigger.
4. For **Should partial result be reported as a good-read?** select No.
5. Select the quantity of each symbology type to be verified in a single trigger.
6. Select the appropriate **Sorting Priority**.
7. Return to the TruCheck window and initiate a verification.
For multiple verifications, either a single region can be selected to identify all symbols to be verified or the entire field of view can be used.

After a successful verification of multiple symbols, the arrows at the top of the TruCheck verification window allow the individual results to be seen in each tab on the TruCheck window. If all verifications pass, the box is green. If any verification fails, the box is red.



Any Code Quality reports saved include an appended report containing each individual result for the individual barcodes verified.

Examining the Results

This section details how the results of the verification can be viewed and analyzed.

1D & 2D Verification

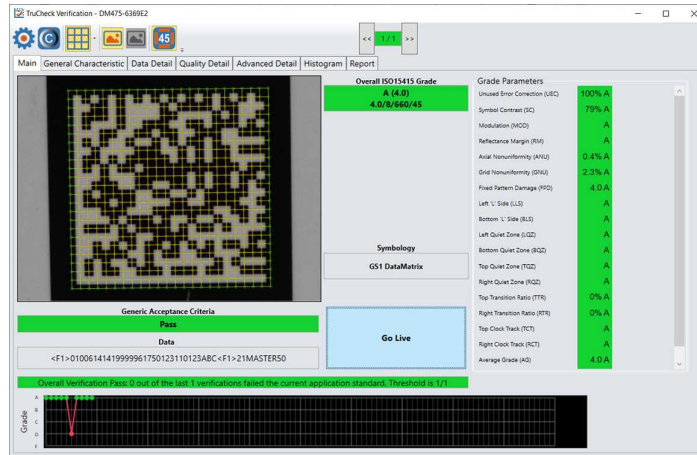

Main Tab

The Main tab shows a snapshot of the verification results.

Acceptance Criteria: Provides a Pass/Fail grade for the barcode and is dependent on the Application Standard selected.

Data: Shows the decoded data. If the data is longer than the box provided, the data develops a scroll bar to show the remaining data.

Overall Grade: Shows the overall grade results for the barcode as both a letter grade and numeric grade in the format of A (4.0). A Formal Grade is provided in the format “Grade/Aperture/Wavelength/Lighting”. For example, a Formal Grade of “4.0/08/660/45” is interpreted as receiving a grade of 4.0 using 8 mil aperture (0.2 mm), 660 nm wavelength, and 45° lighting.

Format Grade: Provides the Format Grade of the barcode and is dependent either on the Application Standard or Data Format Check criteria selected.

Symbology: Reports what type of symbology was detected and used for verification.

Grade Parameters: Provides information on the Quality Parameters grading for the barcode. More information for these parameters is found on the Quality Detail tab. If the Grade Parameters is not visible on the Main menu, select the arrow on the right side of the menu to open it.

Grade Trending:

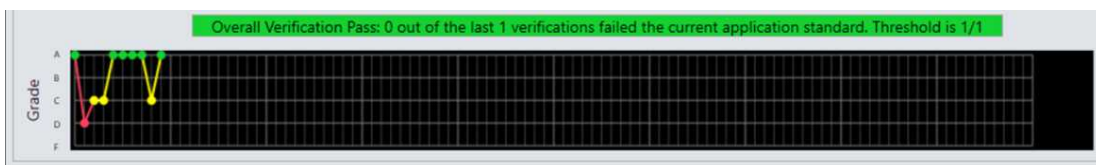

The TruCheck window shows the grade trending values for symbol verified over time. The graph at the bottom of the Main window shows data points associated with the overall grade for each symbol verified. The grade trending reports the data point for each Overall Grade. In verifications where a symbols fails the acceptance criteria for any reason such

as data parsing error or x-dimension range, the grade is shown as an F. For example, if a symbol receives an overall grade of A(4.0) but fails for a X-dimension out of range, grade trending marks the data point as an F.

The screenshot shows the 'TruCheck Verification Settings' dialog box. The 'Application Settings' tab is selected. The 'Application Standard' is set to 'Generic'. The 'Grading Standard' is set to 'ISO 29158 (AIM-DPM)'. The 'Data Format Check' is set to 'None'. The 'Min X Dimension (mils)' is 5 and the 'Max X Dimension (mils)' is 30. The 'Pass Grade' is set to 'C (>1.5)'. The 'QR Quiet Zone' is set to 'ISO 18004 Quiet zone requirement (4)'. The 'Calibration Reminder' is set to 30 days. The 'Trending' checkbox is checked, and the 'X number of verifications' is 1 and the 'Y number of verifications' is 10. A red box highlights the 'Trending' section.

Enable or disable grade trending using the **Trending** checkbox in the **Application Settings** menu and set a tolerance range for the number of verifications (x) allowed to fail out of the total number of verifications (y) specified. If the trending point falls below the specified threshold, trending is reported as an Overall Verification Failure. The Pass Grade value set in the **Application Settings** menu determines if a symbol is considered a pass or fail for grade trending purposes. Grade trending does not show data points for verifications that result in a NO DECODE evaluation.

Note: Grade trending data points remain populated and continue to trend on the **Main** window until the power is disconnected from the verifier.

General Characteristics Tab

The **General Characteristic** tab shows the physical characteristics of the verified barcode.

The image shows the characteristics of a Data Matrix barcode:

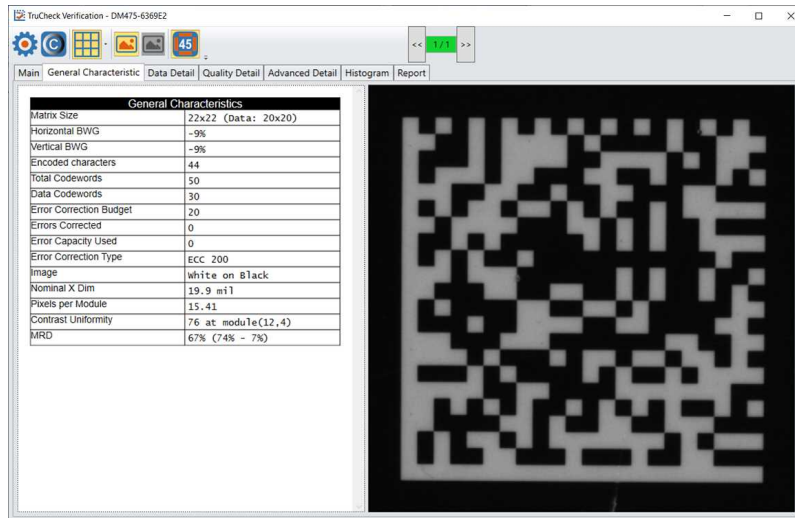

The **Contrast Uniformity** value, which is important for verifying conformance with ISO/IEC 15426-2 is also shown in this tab. Some of the contents of this screen depends on the symbology and settings on the **Report Settings** menu.

The image shows the characteristics of a 1D barcode:

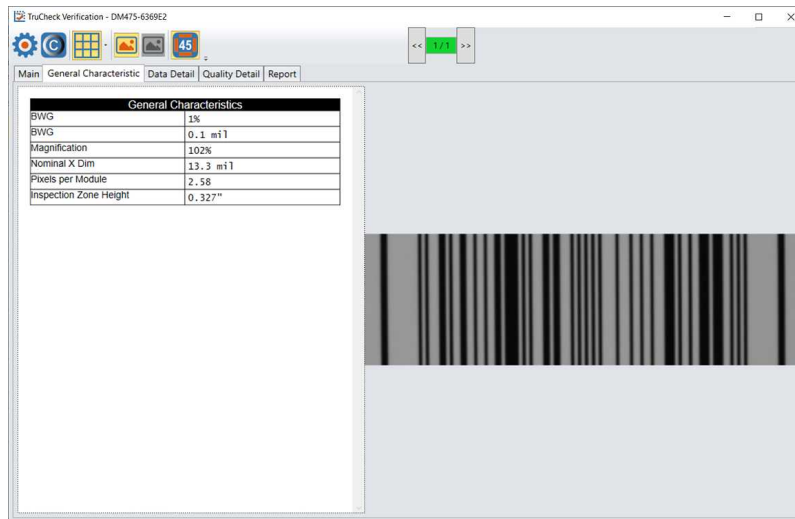

Data Detail Tab

The **Data Detail** tab shows all of the data content of the symbol. Detail depends on the symbology and the selected application standards.

The image shows a Data Matrix with encoding information:

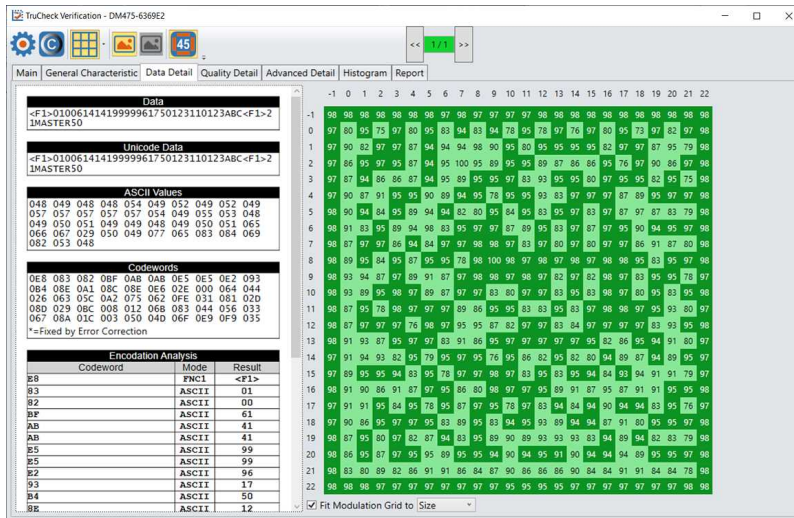

When a data checking failure occurs, a message indicates the cause of the failure. For example, if a check digit is incorrect, a message indicates the expected check digit value. When an error is detected, it is reported and the parsing is stopped.

The image shows the Data Matrix with encoding information along with a depiction of the symbol to the right showing each module.

When the cursor is placed over the codewords reported in the Data Matrix Codeword table, the eight modules of that codeword are highlighted within the image depiction to show where the data is encoded within a data matrix symbol.

Quality Detail Tab

The **Quality Detail** tab shows the measured quality parameters and lists the formal grade. Different symbologies and quality grading standards display pertinent data here.

For example, the image shows the characteristics of a 2D Data Matrix code graded according to ISO 15415:

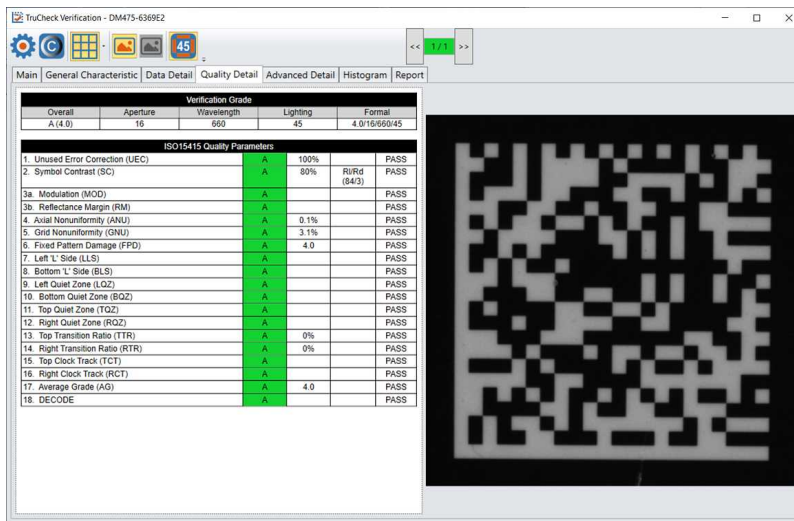

The image shows the characteristics of a 1D UPC-A symbol graded according to ISO 15416:

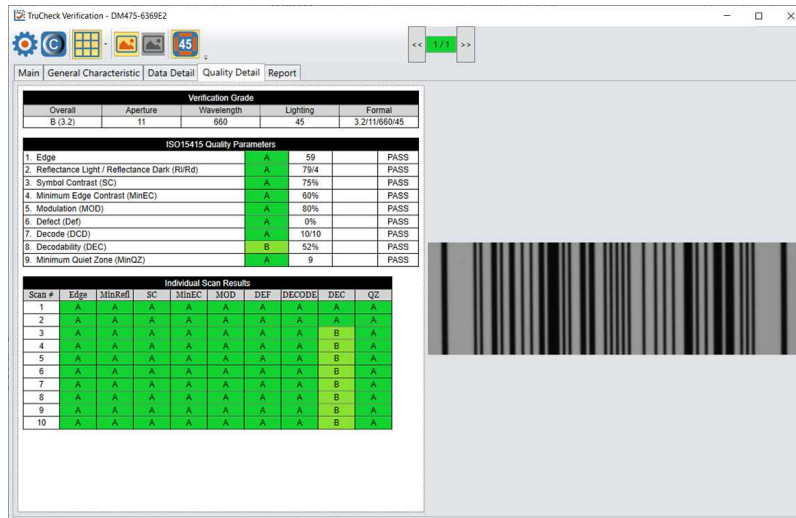

For more information on grading standards, see [Grading Standards and their Parameters on page 39](#).

Advanced Detail Tab

The **Advanced Detail** tab shows in-depth information on the verified code. The information shown depends on the type of the verified barcode.

The example shows the modulation values from a Data Matrix symbol:

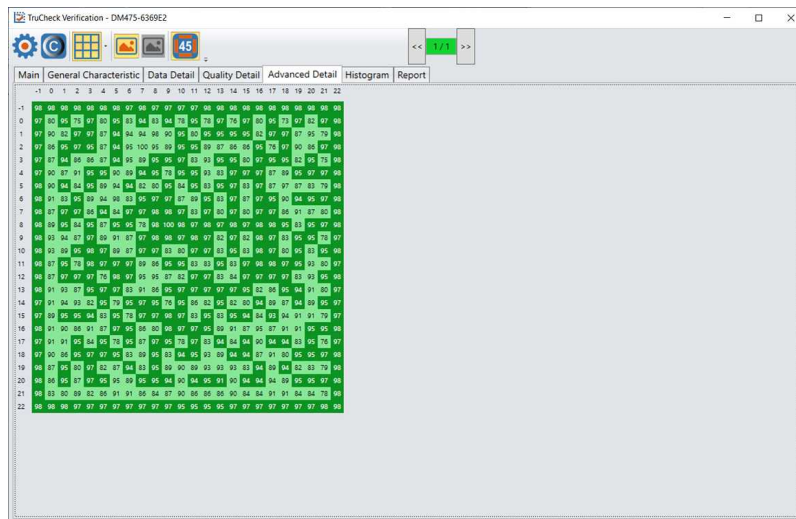

For more information on modulation calculation, see [Grading Standards and their Parameters on page 39](#).

Histogram Tab

The **Histogram** tab shows the analysis of the reflectivity of each cell and associated grade.

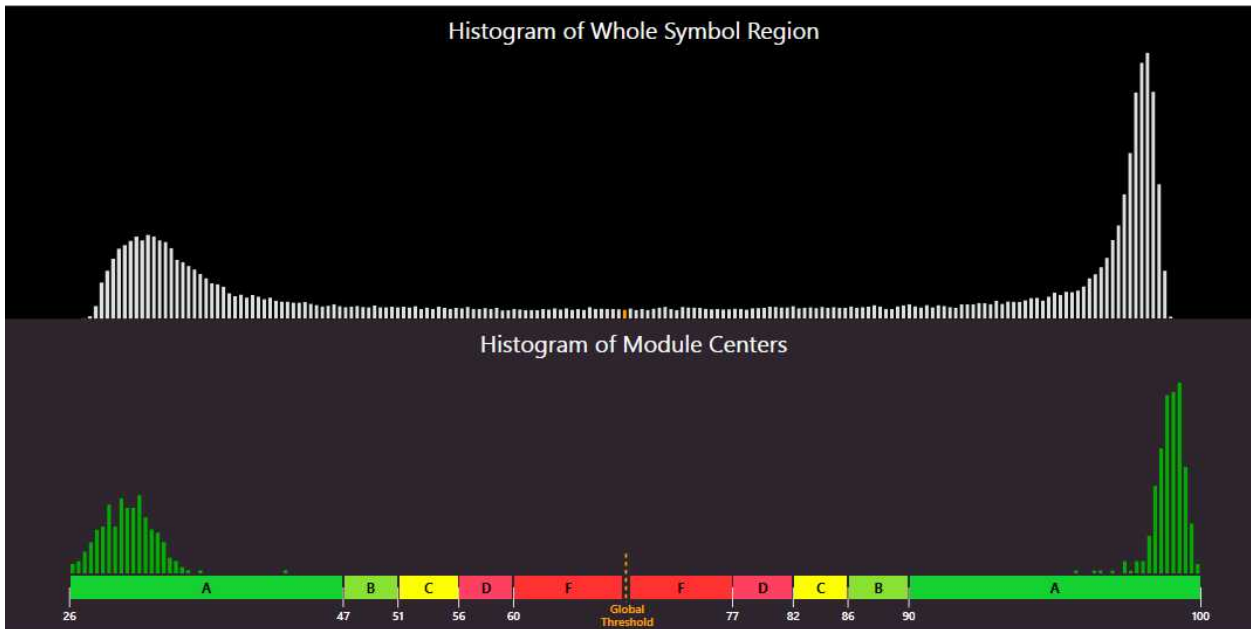

The horizontal axis on the histogram represents the brightness level with the dark elements on the left and the bright elements on the right. The brighter the element is, the further to the right it is. The height of each bar represents the number of elements with the brightness associated with its position on the horizontal axis.

The top graph is a histogram representing the brightness of all the pixels in the image. The bottom graph represents the center of modules in the symbol. The bottom graph only contains elements which are either definitively dark or definitively bright. The bars are grouped together because all the dark or bright modules of varying brightness are close to each other. In the upper histogram pixels between dark and bright are represented. These pixels are on the border between dark and light modules, therefore they obtain a middle value of brightness.

The horizontal axis contains markers showing the global threshold (tall line) and the separation between B and C, and between C and D modulation levels for both dark and light elements.

Note: When grading according to ISO/IEC TR29158 (AIM-DPM), the histogram is labeled differently. The 0% and 100% labels on the horizontal axis are located at the means of the dark and light lobes of the histogram and there is no C level because the DPM grading method uses only A, B, D and F levels for Cell Modulation.

Report Tab

To enable the Code Quality report to show in the **Report** tab, check the box for **Generate Code Quality reports** in the **Results History** pane of Setup Tool.

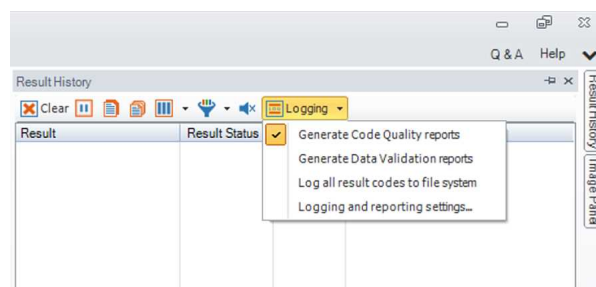

Note: The Code Quality report contains the results specific to verification when the verification feature key is installed and Verification is enabled in the Setup Tool window. The Code Quality report contains the results specific to verification and separate from the previous Code Quality results that Process Control Metrics (PCM) normally generated.

When the **Code Quality report** is enabled, the **Report** tab is populated in the **TruCheck Verification** window to show the results for a verification.

Settings

This section describes the settings you can make and the options you have in the **TruCheck Verification** window.

Accessing the Settings Menu

To access **Settings**, select the **Settings** icon in the upper left hand corner of the interface.

Application Settings

The content of the **Application Settings** window depends on the Application Standard selected, since the application standard setting automatically selects many parameters. The **Generic** application standard allows you to select all adjustable verification and process parameters in a custom way. Selecting a pre-defined application standard ensures that the Verifier uses the appropriate grading parameters for your application.

The **Reset Defaults** button resets the **Application Settings** menu to the default settings. After clicking **Reset Defaults**, you must calibrate the verifier before using it.

Application Standards Settings

Application standards configure the verifier to grade according to pre-defined rules established by an industry standards body or other industry requirements.

Select one of the options provided in the drop down box to specify the application standard.

You have the following setting options available within each of these standards:

GS1

The GS1 application standard allows codes to be verified according to GS1 General Specifications. GS1 General Specifications contain several categories of applications which are described in its Tables 1-11. You can select from among these tables to specify the application category for your codes. Consider the following examples:

Note: Since the X-dimension of the decoded symbol is used to deduce which table applies, it can be incorrect if your X-dimension is outside of the range allowed in your application. To be sure that the verifier is checking all of the proper requirements for your application, select the Table in the GS1 General Specifications that applies to your application.

The GS1 table used is reported in the **Notes** section of the report. For more information on the tables used for analysis, refer to the tables provided in the [GS1 General Specifications Standard](#).

In addition to which Table of the GS1 General Specifications to use, you can also specify ISO/IEC 15415 grading generally used for labels or ISO/IEC 29158 (AIM-DPM) as the grading method.

MIL-STD-130 UID

The MIL-STD-130 UID application standard properly reports the quality standard used to grade the code and the data structure used in Construct 1 or Construct 2 for UID marks specified in MIL-STD 130. The MIL-STD spells out acceptable grades and requirements for data format.

You must specify either ISO 15415 grading or ISO 29158 (AIM-DPM) grading.

Select **Dot Peen** if it is applicable.

TruCheck Verification Settings

Application Settings

Report Settings

Navigation

Application Standard

Select Standard: UID (MIL-STD-130)

Grading Standard

ISO 15415/6

ISO 29158 (AIM-DPM)

Dot Peen

QR Quiet Zone

ISO 18004 Quiet zone requirement (4)

ISO 16480 Quiet zone requirement (1)

Trending

Overall verification failure when X out of the last Y verifications fail the current application standard.

X number of verifications: 1

Y number of verifications: 1

Calibration Reminder

Days until calibration reminder: 30

Reset Defaults

OK

UDI/HIBC

The UDI/HIBC application standard checks symbols that meet UDI requirements using either GS1 or HIBCC guidelines.

You must specify either ISO 15415 grading or ISO 29158 grading.

Select **Dot Peen** if applicable.

Since the data content required for UDI compliance varies depending on the medical device, only the data format (not the content) is validated. Data is automatically validated in accordance with formatting rules of the chose guidelines.

TruCheck Verification Settings

Application Settings

Report Settings

Navigation

Application Standard

Select Standard: UDI (GS1 or HIBCC)

Grading Standard

ISO 15415/6

ISO 29158 (AIM-DPM)

Dot Peen

QR Quiet Zone

ISO 18004 Quiet zone requirement (4)

ISO 16480 Quiet zone requirement (1)

Trending

Overall verification failure when X out of the last Y verifications fail the current application standard.

X number of verifications: 1

Y number of verifications: 1

Calibration Reminder

Days until calibration reminder: 30

Reset Defaults

OK

Generic

Apply the Generic standard option when you are grading a code that is not expected to adhere to any pre-defined industry conformance standard, and so it can be customized with specific settings for:

- Aperture Size
- Minimum Acceptable Pass Grade
- Minimum and Maximum X-dimension
- Grading Method: ISO 15415 or ISO 29158

- Data Parsing and Validation

TruCheck Verification Settings

Application Settings

Report Settings

Navigation

Application Standard

Select Standard: Generic

Grading Standard

ISO 15415/6

ISO 29158 (AIM-DPM)

Dot Peen

Min X Dimension (mils): 5

Max X Dimension (mils): 30

Pass Grade: C (>1.5)

QR Quiet Zone

ISO 18004 Quiet zone requirement (4)

ISO 16480 Quiet zone requirement (1)

Calibration Reminder

Days until calibration reminder: 30

Data Format Check

None

GS1

HIBCC

ISO 15434

Aperture Setting: Auto Aperture

Trending

Overall verification failure when X out of the last Y verifications fail the current application standard.

X number of verifications: 1

Y number of verifications: 1

Reset Defaults

OK

Auto

Apply the Auto application standard option to allow the verifier to select the correct application standard based on the structure of the barcode data. If the data structures for GS1, HIBCC, or MIL-STD-130 standards are detected within the symbol during verification, the verification is executed using the correct application standard.

Note: In case of printing a symbol that contains a data structure which is not to be graded according to the automatically selected application standard, use the Generic application standard instead.

Grading Standards

For any Application Standard selected, you must use either ISO 15415 or ISO 29158 (AIM-DPM) depending on your application.

- **ISO 15415:** Reports and displays according to ISO/IEC 15415 which is typically used for label based codes.
- **ISO 29158 (AIM-DPM):** Select to use the AIM-DPM verification standard. ISO 29158 (AIM-DPM) can be used with or without the Dot Peen selection. When using AIM-DPM Grading, the X-Dimension Range is used instead of the aperture setting in accordance with the AIM-DPM methodology.

Data Format Check

You can apply a specific **Data Format Check** criteria to the data content of the code or leave the option as **None**. If a specific Data Format Check is applied, a Data Format Check grading box appears on the main screen of the User Interface to show the Pass/Fail grade provided. A Data Format Check table is provided on the report showing detailed parsing information.

- **GS1:** The GS1 option checks the format of the data against GS1 formatting rules. These codes generally begin with a Function 1 <F1> character.
- **HIBCC:** The HIBCC option checks the format of the data against HIBCC formatting rules. These codes generally begin with a + character.

- **ISO 15434:** The ISO 15434 option checks data for many industry standards which encode information using ISO/IEC 15434 data structures. These codes generally begin with the sequence `]]><RS>nn<GS>` where `nn` are two digits which are typically 05, 06 or 12. MIL-STD-130 and some shipping container applications use this formatting style.

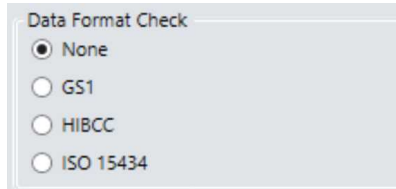

Data Format Check

None

GS1

HIBCC

ISO 15434

Dot Peen

Use the dot peen option for codes created through a process where dots are peened onto a metal surface. Select **Dot Peen** to use the AIM-DPM Stick algorithm to connect dots.

Min X-Dimension (mils)

You can set a minimum x-dimension value that is allowed during verification. The lowest value that can be set is 1 mil. Any code that falls below the minimum x-dimension set receives a grade of FAIL (X Dimension out of Range). If no minimum x-dimension is specified, the application defaults to 5 mils.

Max X-Dimension (mils)

You can set a maximum x-dimension value that is allowed during verification. The highest value that can be set is 100 mils. Any code that is above the maximum x-dimension set receives a grade of FAIL (X Dimension out of Range). If no maximum x-dimension is specified, the application defaults to 30 mils.

Pass Grade

Select a minimum passing grade based on a certain letter or numerical value (that is, $C > 1.5$). Any code verified that does not receive an Overall Grade above the Pass Grade minimum set receives a grade of Fail for Pass Grade on the User Interface and Report.

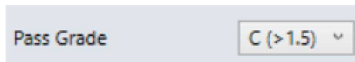

Pass Grade C (>1.5) ▾

QR Quiet Zone

You can select either ISO 18004 Quiet zone requirements of a 4 module-sized quiet zone or ISO 16480 Quiet zone requirement of a 1 module-sized quiet zone.

Aperture Setting

The size of the synthetic aperture used to produce the blurred reference image that is an integral part of ISO 15415 grading. Choose the size of the aperture with care because it has a profound effect on the grade, according to the requirements of your application. In general, larger aperture sizes reduce the sensitivity to defects in printing, and also reduce the ability to resolve small elements in a code. Consequently, the size of the aperture is limited by the X-dimension of your symbols, or conversely the X-dimension of your symbols is limited by the size of your aperture. Aperture size can be called out in the application specification, quality specification, or both. If you are unsure of the aperture size to select, choose **Auto** and the verifier uses guidance supplied within ISO 15415 to choose an aperture size based on the X-dimension of the code.

The aperture setting is used when grading in accordance with ISO/IEC 15415, but it is not used when grading in accordance with AIM-DPM. While AIM-DPM grading does include a blurred reference image, just like ISO 15415, the aperture size is dictated by the AIM-DPM grading method to be either 50% or 80% of the symbol X-dimension automatically.

You must specify an aperture size for the Generic standard when using ISO/IEC 15415.

In the drop down menu, select one of the following:

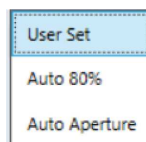

User Set

The application allows you to specify the aperture setting. When **User Set** is selected, an additional drop down menu pops up for you to select the correct aperture.

Auto 80%

The application automatically chooses an aperture size based on 80% of the X-dimension.

Auto Aperture for 2D Barcodes

The application automatically chooses an aperture size based on the X-dimension in accordance with the suggestion in ISO/IEC 15415.

X-Dimension	Aperture
≤ 6 mil	02 (2 mil)
$6 \text{ mil} < x \leq 7.5$ mil	03 (3 mil)
$7.5 \text{ mil} < x \leq 10$ mil	05 (5 mil)
$10 \text{ mil} < x \leq 20$ mil	08 (8 mil)
$20 \text{ mil} < x \leq 30$ mil	16 (16 mil)
≥ 30 mil	20 (20 mil)

Note: AIM-DPM grading (ISO/IEC TR 29158) always selects an aperture automatically based on the X- Dimension of the decoded symbol, which overrides the above rules. These rules only apply to ISO/IEC 15415 grading when **Auto Aperture** is selected.

Auto Aperture for 1D Barcodes

The application automatically chooses an aperture size based on the X-dimension in accordance with the suggestion in ISO/IEC 15416. For the Generic application standard, the following table is used for most symbologies:

X-Dimension	Aperture
≤ 7.0 mil	03 (3 mil)
$7.1 \text{ mil} < x \leq 13$ mil	05 (5 mil)
$13 \text{ mil} < x \leq 25$ mil	10 (10 mil)
> 25 mil	20 (20 mil)
For UPC/EAN, regardless of X-dimension or magnification	06 (6 mil)

You can override these rules by specifying a specific aperture directly for any application that requires a specified aperture. An application specification (such as GS1 Gen Spec, or MIL-STD 129) specifies an aperture value which can be different than what the rules in the table would yield.

Scripting

Setup Tool allows you to customize a script for outputting results. Scripting can be used to output a wide variety of information. For more details on customizing and making your own scripts, refer to the **DataMan Communications and Programming Guide**. For verification results, two scripting templates are provided listing the most common output formats for verification results which can be generated to a csv or an html report.

To enable scripting using the scripting templates provided, select the **Format Data** icon and the radio button for Script-Based Formatting.

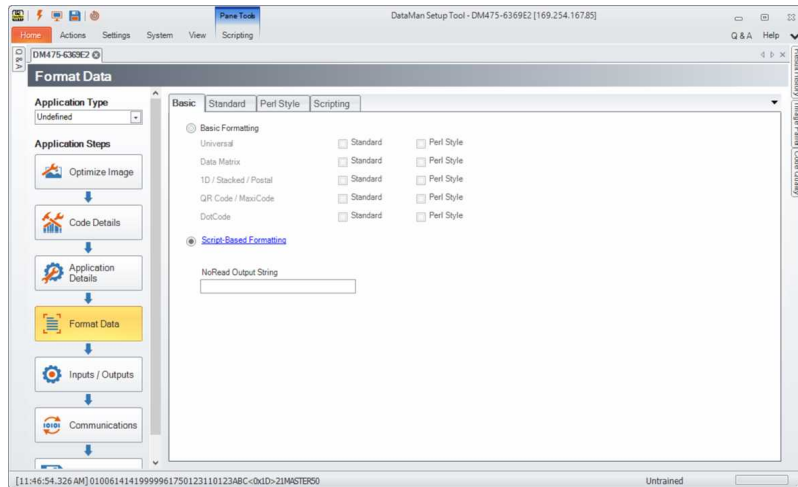

Select the **Scripting** tab. In the **Scripting** pane on the toolbar, select **Open Script**.

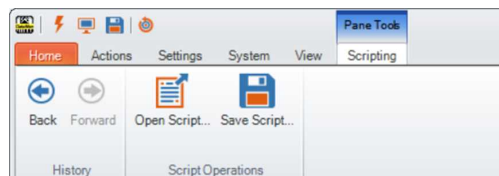

The scripting templates can be found in the following location:

C:\Program Files (x86)\Cognex\DataMan\DataMan Software vx.x.x\Scripts

One scripting template generates results to a .csv file and the other generates results to an .html file.

To save the output to a file and specify a file name and location, select the **Results History** tab on the right window. In the **Logging** option, check the box to **Log all result codes to file system** and select the option for **Logging and reporting settings....**

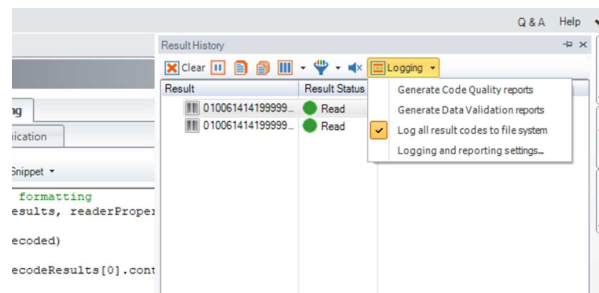

In the **Logging and reporting settings** menu, select a file **Path** and **File Name** under the **Result Code** section. After providing a **File Name**, you must include either “.csv” or “.html” depending on which template is selected. Select **OK** to save and exit.

Note: If you do not include .csv or .html after the file name, it will not save the report correctly.

Result Code	
Path	C:\
File Name	sample report.html

You can customize the scripts to show more or less detail. For the full list of scripting options, see the **DataMan Communications and Programming Guide**.

Grading Standards and their Parameters

ISO/IEC 15415 Grading Parameters

- **UEC (Unused Error Correction)** is the percentage of error correction capability that is available for further incorrect modules. The assignment of grade is according to the following table:

UEC %	Grade
> 62	A (4.0)
> 50 (but less than 62)	B (3.0)
> 37 (but less than 50)	C (2.0)
> 25 (but less than 37)	D (1.0)
< 25	F (0)

- **SC (Symbol Contrast)** is the difference in reflectivity between the brightest module and the darkest module. The assignment of grade is according to the following table:

SC%	Grade
> 70	A (4.0)
> 55 (but less than 70)	B (3.0)
> 40 (but less than 55)	C (2.0)
> 20 (but less than 40)	D (1.0)
< 20	F (0)

- **MOD and RM (Modulation)** is a grade based on the amount of variability in reflectivity of the modules. A multi-step process is used to get the modulation grade. First, the reflectivity of each module is compared to the global threshold and the overall symbol contrast according to the following formula:

$$\text{MOD} = 2 * (\text{abs}(R - \text{GT})) / \text{SC}$$

The Global Threshold GT is the midpoint between the reflectance of the brightest module and the reflectance of the darkest module. Next, the grade level for each module is determined from the MOD value according to the following table:

MOD %	Grade
> 50	A (4.0)
> 40 (but less than 50)	B (3.0)
> 30 (but less than 40)	C (2.0)
> 20 (but less than 30)	D (1.0)
< 20	F (0)

The value of the grade for the Modulation parameter is the highest modulation level for which the modules meeting that level result in a notional Unused Error Correction grade of that level or higher. The module with the lowest MOD is reported as Contrast Uniformity (CU) in General Characteristics to facilitate conformance testing to the requirements of ISO/IEC 15426-2.

The RM parameter works in a similar way, except that for modules which error correction corrects as errors, the MOD% is taken as 0 and counts as F in the final evaluation of the Modulation parameter grade according to the notional Unused Error Correction grade.

- **ANU (Axial Non-uniformity)** is the amount of “out of square” the modules are, that is, a measure of the overall aspect ratio of the symbol. For rectangular symbols which are supposed to be non-square, the ANU parameter reports the deviation from its “correct” aspect ratio.

ANU %	Grade
≤ 6	A (4.0)
< 8 (but more than 6)	B (3.0)
< 10 (but more than 8)	C (2.0)
< 12 (but more than 10)	D (1.0)
> 12	F (0)

- **GNU (Grid Non-uniformity)** is the worst-case distance between the calculated center of a module and the ideal location for the center of the module based on perfectly evenly spaced modules. The calculated center of the module is determined using clock track edges in accordance with the reference decode algorithm. The value is reported as a percentage of a module size.

GNU %	Grade
≤ 38	A (4.0)
< 50 (but more than 38)	B (3.0)
< 63 (but more than 50)	C (2.0)
< 75 (but more than 63)	D (1.0)
> 75	F (0)

- **FPD (Fixed Pattern Damage)** is the overall grade for all the fixed pattern components. This grade is equal to the lowest grade of all the components listed below. The following is a list of components of the finder pattern for Data Matrix symbols. For QR Code symbols, the parameters described in ISO 18004 QR Code Grading Parameters on page 1 are applicable.
- **LLS (Left ‘L’ Side)** is a grade based on imperfections in the left ‘L’ side of the finder pattern. There are two checks required to pass. The first requires gaps to be three modules or less and that gaps are separated by stretches of at least four correct modules. The second assigns a grade based on the overall percentage of correct modules according to the following table:

% of incorrect modules	Grade
0	A (4.0)
< 9 (but more than 0)	B (3.0)
< 13 (but more than 9)	C (2.0)
< 17 (but more than 13)	D (1.0)
> 17	F (0)

The grade is the highest modulation level in which the first (gap test) passes and the correct module percentage results in a grade of that level or higher.

- **BLS (Bottom ‘L’ Side)** is a grade based on imperfections in the bottom ‘L’ side of the finder pattern (see Left ‘L’ Side).
- **LQZ (Left Quiet Zone)** is a grade based on imperfections in the quiet zone, which is a one-module area to the left of the left ‘L’ side. The grade is based on the percentage of modules, which are correct using the same grading table as for the ‘L’ sides.
- **BQZ (Bottom Quiet Zone)** is a grade based on imperfections in the quiet zone, which is a one-module area below the bottom ‘L’ side.

- **TQZ (Top Quiet Zone)** is a grade based on imperfections in the quiet zone, which is a one-module area above the Top Clock Track.
 - **ULQZ (Upper Left Quiet Zone)** is the top quiet zone above the upper left quadrant. Used only for 2 and 4 quadrant symbols, this is the grade based on the segment of the quiet zone above the top clock track of the left quadrant.
 - **URQZ (Upper Right Quiet Zone)** is the top quiet zone above the upper right quadrant. Used only for 2 and 4 quadrant symbols, this is the grade based on the segment of the quiet zone above the top clock track of the right quadrant.
- **RQZ (Right Quiet Zone)** is a grade based on imperfections in the quiet zone, which is a one-module area to the right of the Right Clock Track.
 - **RUQZ (Right Quiet Zone to the right of the upper right quadrant):** Only for 2 and 4 quadrant symbols, this is the grade based on the segment of the quiet zone to the right of the upper right quadrant.
 - **RLQZ (Right Quiet Zone to the right of the lower right quadrant):** Only for 4 quadrant symbols, this is the grade based on the segment of the quiet zone to the right of the lower left quadrant.
- **TTR (Top Transition Ratio)** is a grade based on imperfections in the top clock track, with relation to its adjoining quiet zone. The ratio is the number of transitions from light to dark or dark to light in the quiet zone divided by the number of transitions in the clock track. Since the number of transitions in the quiet zone is zero, the ideal value for this parameter is zero. A small number of transitions can be tolerated as long as the ratio remains low. As the number of teeth in the clock track increases (larger symbols), more transitions in the quiet zone can be tolerated. More transitions in the clock track, which are really imperfections, also improve this measurement. The grading scheme for this transition ratio is:

Transition Ratio %	Grade
< 6	A (4.0)
< 8 (but more than 6)	B (3.0)
< 10 (but more than 8)	C (2.0)
< 12 (but more than 10)	D (1.0)
> 12	F (0)

The value of the grade is the highest modulation level for which the ratio gives a grade from the above table of that modulation level or higher.

- **ULQTTR (Transition ratio for Upper Left Quadrant Top Clock Track):** Only for 4 quadrant symbols, this is the grade based on the clock track segment at the top of the upper left quadrant. For a 2 quadrant symbol, this is labeled LQTTR.
- **URQTTR (Transition ratio for Upper Right Quadrant Top Clock Track):** Only for 4 quadrant symbols, this is the grade based on the clock track segment at the top of the upper right quadrant. For a 2 quadrant symbol this is labeled RQTTR.
- **LLQTTR (Transition ratio for Lower Left Quadrant Top Clock Track):** Only for 4 quadrant symbols, this is the grade based on the clock track segment at the top of the lower left quadrant.
- **LRQTTR (Transition ratio for Lower Right Quadrant Top Clock Track):** Only for 2 and 4 quadrant symbols, this is the grade based on the clock track segment at the top of the lower right quadrant.

RTR (Right Transition Ratio): Transition ratio (see Top Transition Ratio) for the right clock track in relation to the right quiet zone

- **ULQRTR (Transition ratio for Upper Left Quadrant Right Clock Track):** Only for 2 and 4 quadrant symbols, this is the grade based on the clock track segment to the right of the upper left quadrant. For a 2 quadrant symbol, this is labeled LQRTR
 - **URQRTR (Transition ratio for Upper Right Quadrant Right Clock Track):** Only for 2 and 4 quadrant symbols, this is the grade based on the clock track segment to the right of the upper right quadrant. For 2 quadrant symbols, this is labeled RQRTR.
 - **LLQRTR (Transition ratio for Lower Left Quadrant Right Clock Track):** Only for 4 quadrant symbols, this is the grade based on the clock track segment to the right of the lower left quadrant.
 - **LRQRTR (Transition ratio for Lower Right Quadrant Right Clock Track):** Only for 4 quadrant symbols, this is the grade based on the clock track segment to the right of the lower right quadrant.
- **TCT (Top Clock Track)** is a grade based on imperfections in the top clock track. Some imperfections in the clock track can be tolerated. As a rule maintaining for a passing grade is that three out of every five modules on a consecutively rolling window of five modules must be correct. The value of the grade is the highest modulation level for which this test passes.
 - **ULQTCT (Top Clock Track for Upper Left Quadrant):** Only for 2 and 4 quadrant symbols, this is the grade based on the clock track segment at the top of the upper left quadrant. For 2 quadrant symbols this is labeled LQTCT.
 - **URQTCT (Top Clock Track for Upper Right Quadrant):** Only for 2 and 4 quadrant symbols, this is the grade based on the clock track segment at the top of the upper right quadrant. For 2 quadrant symbols this is labeled RQTCT.
 - **LLQTCT (Top Clock Track for Lower Left Quadrant):** Only for 4 quadrant symbols, this is the grade based on the clock track segment at the top of the lower left quadrant.
 - **LRQTCT (Top Clock Track for Lower Right Quadrant):** Only for 4 quadrant symbols, this is the grade based on the clock track segment at the top of the lower right quadrant.
- **RCT (Right Clock Track)** is a grade based on imperfection in the right clock track. See Top Clock Track.
 - **ULQRCT (Right Clock Track for Upper Left Quadrant):** Only for 2 and 4 quadrant symbols, this is the grade based on the clock track segment to the right of the upper left quadrant. For 2 quadrant symbols, this is labeled LQRCT.
 - **URQRCT (Right Clock Track for Upper Right Quadrant):** Only for 2 and 4 quadrant symbols, this is the grade based on the clock track segment to the right of the upper right quadrant. For 2 quadrant symbols, this is labeled RQRCT.
 - **LLQRCT (Right Clock Track for Lower Left Quadrant):** Only for 4 quadrant symbols, this is the grade based on the clock track segment to the right of the lower left quadrant.
 - **LRQRCT (Right Clock Track for Lower Right Quadrant):** Only for 4 quadrant symbols, this is the grade based on the clock track segment to the right of the lower right quadrant.

- **AG (Average Grade of Damage across many parts of the Finder Pattern)** is a grade that considers the accumulated effect of damage to several parts of the finder pattern. Five values are averaged together. One of these is the lowest of all the grades associated with all the clock track segments, namely TCT, TTR, TQZ and RCT, RTR, RQZ. The other four are LLS, BLS, LQZ, and BQZ. The average must fall in the range of 0.0 through 4.0 and is given a grade according to the following:

Ave Grade	Grade
Equals 4.0	A (4.0)
≥ 3.5 (but less than 4.0)	B (3.0)
≥ 3.0 (but less than 3.5)	C (2.0)
≥ 2.5 (but less than 3)	D (1.0)
< 2.5	F (0)

Note: The effect of the AG parameter is to lower the overall grade of symbols, which have several individual parameters at or near the same level. For example, with enough B grades in individual parameters, the overall grade may come out as a C grade rather than a B.

- **DECODE:** Reports whether the 2D Symbol is decoded in accordance with the reference decode algorithm with the specified aperture.

Note: It is possible to report decoded results, but for a failure to occur when decoding in accordance with the reference decode algorithm. In this case, the DECODE grade is F (0).

Contrast Uniformity (CU) is the value of MOD (modulation) for the worst case module selected from a 2D Matrix symbol. This is useful for process control, as way of measuring the drift in reflectivity consistency, and for testing conformance to ISO/IEC 15426-2, which requires the modulation of a specific module within a conformance test symbol to be reported. This parameter is reported in General Characteristics.

ISO 29158 (AIM-DPM) 2006 Grading Parameters

The ISO 29158 (AIM-DPM) method of grading Data Matrix symbols modifies the process of ISO-15415 and is appropriate for direct part marking applications. This standard is more representative of the scanning performance of modern readers that are designed in some cases for these demanding applications. In this method, the image brightness is adjusted to produce an image of the symbol that fills most or all of the dynamic range of the imager, resulting in an image that is easy to see. The threshold between dark and light is calculated from the statistics of the image brightness histogram. Therefore, the measurements calculated by AIM-DPM differ from those of ISO 15415 significantly. Some of the parameters reported in ISO 15415 are changed so drastically and are renamed to avoid confusion between the two methods:

AIM-DPM Parameter Name	ISO 15415 Parameter Name	Summary of Change(s)
CC (Cell Contrast)	SC (Symbol Contrast)	Made relative to light background.
CM (Cell Modulation)	MOD (Modulation)	Threshold calculated from statistics rather than the maximum and minimum reflectance. Grading scale range set to Mean of distribution, rather than maximum and minimum reflectance.
DD (Distributed Damage)	AG (Average Grade)	Modulation overlay uses only A, B, D, and F levels instead of A, B, C, D, and F.
MR (Minimum Reflectance)	Not necessary, since SC is measured on an absolute scale.	An absolute limit on SC of 5% added to temper the relative nature of CC and “catch” extremely low contrast symbols.

Fixed Pattern Damage grading parameters, except for AG, are not renamed, but are functionally different since the global threshold and modulation grading scale are different. As symbols obtain a significantly higher grade according to AIM-DPM than ISO 15415, grading according to AIM-DPM is appropriate only when called for in an application specification.

Another difference is the allowance for a variety of illumination options. These include the four-sided 45° light that is the default for ISO 15415. Additional lighting angles allowed are 30° lighting from four sides, 30° from two sides, which can be either North/South or East/West, 30° from one side, and 90° diffuse on-axis lighting. The used light source is reported using a notation that includes the angle, and a letter (Q for 4, T for two, S for single).

AIM-DPM also varies the size of the aperture until the symbol is decoded, then the grading is repeated with 50% and 80% aperture sizes. The better of the two is reported as the final grade.

Note: When the reference decode algorithm fails to decode a symbol with both 50% and 80% aperture, the **DECODE** grade is “F” and a note is printed on the grade section of the report, even if the symbol is recognized and decoded with a different aperture size in an earlier phase of the grading procedure.

The following parameters are new or modified for AIM-DPM:

- **CC (Cell Contrast):** The relative contrast value between bars and spaces, taken from the means of the light and dark element $CC = (L_{mean} - D_{mean}) / L_{mean}$.

CC%	Grade
≥ 30%	4
≥ 25%	3
≥ 20%	2
≥ 15%	1
< 15%	0

- **CMOD (Cell Modulation):** Similar to MOD in ISO 15415, CMOD measures the deviation in the reflectivity of dark and light elements. A range for each light and dark group is created from the global threshold to the mean reflectance of the elements. Each module is graded along the created range, then error correction capability is considered to “discount” the effect of one or a few elements with low values, and a final grade is computed for this parameter.
- **DDG (Distributed Damage Grade):** Similar to AG in ISO 15415, DDG considers the effect of multiple segments of the fixed pattern having imperfections. Where multiple segments have a low grade, the effect of this “distributed damage” is reflected in a lower grade for DDG than the lowest of the individual segments.
- **MR (Minimum Reflectance):** This is a requirement for at least 5% reflectance difference between light and dark elements as a restraint on the purely relative CC parameter.
- **Decode:** Decode grade A or F depending upon whether the reference decode algorithm succeeds in decoding the symbol with the required final aperture size.

Traditional (Non-Graded) Parameters

PCS

Ways of Quantifying Contrast: Print Contrast Signal (PCS) is an older and rarely used measure of contrast. Contrast is intended to quantify the difference between the bars and the spaces in reflectance. PCS is defined mathematically as:

$$PCS = (R_{max} - R_{min}) / R_{max}$$

The percentage of the light background accounted for by the difference between the bars and spaces. PCS was defined as a measure of contrast the human eye perceives long before and outside the context of measuring barcode contrast. The measurement is made relative to the brightness of the background. The fact that it is relative to the background means that the darker (worse) the background color is, the higher (supposedly better) the value of PCS. Scanners are sensitive to the absolute difference between the reflectance of bars and spaces. Scanners are especially sensitive to variations in contrast within the same scan.

MRD

Minimum Reflectance Difference (MRD) quantifies the minimum difference anywhere across the barcode. MRD considers the brightest (worst) bar and the darkest (worst) space anywhere in the barcode. These worst-case bar and space are not necessary adjacent to one another.

ISO/IEC 15416 (ANSI x3.182) Grading Parameters

The ANSI parameters section lists each of the nine ANSI parameters and gives a summary of the measurements based on all scans taken. For a review of the ANSI process given on each of your codes, check the ANSI Matrix for each code described below.

Note: Some of these parameters are average values over all of the scans, and the averages can skew or alter the apparent results.

The descriptions of each parameter explain what is measured in the case where a barcode is read and not read. When a code is not read, the scan is analyzed for apparent quiet zones and the bars and spaces in between are used for the ANSI analysis.

1. EDGE: Edge Determination

Checks if the edge between bar and space can be detected and no false bars or spaces appear due to “splitting” of bars or ink splattered into spaces. If at least one scan results in a decoded barcode, the EDGE value is the number of bars and spaces, not including quiet zones, in the code. If no scans result in a decoded barcode, the EDGE value shown is the number of bars and spaces found between quiet zones or apparent quiet zones on the scan on which the most bars and spaces were found. The Scan Reflectance Profile graph can also help in analyzing a code that cannot be decoded.

2. R/RD: Minimum Reflectance

Checks if the darkness of the bars is sufficient. The amount of light reflected by the bars (bar reflectance) must be less than half the light reflected by the spaces (space reflectance). The values shown are the light reflectance and the dark element reflectance separated by a slash. The light reflectance is the maximum reflectivity found in the scan (lightest or best space), and the dark reflectivity is the minimum reflectivity found in the scan (darkest or best bar). The requirement is for the minimum reflectivity to be no more than half the maximum reflectivity. If this requirement is met, the grade is A, otherwise it is F.

3. SC: Symbol Contrast

Measures the contrast between the brightest space and darkest bar. The result is assigned a letter grade of A, B, C, D, or F, with A being the highest contrast. The contrast is the difference between the maximum reflectivity (lightest or best space) and the minimum reflectivity (darkest or best bar). Note that Symbol Contrast is the difference between light and dark, and RI/Rd above checks the ratio of these values.

SC %	Grade
≥ 70	A (4.0)
≥ 55 (but less than 70)	B (3.0)
≥ 40 (but less than 55)	C (2.0)
≥ 20 (but less than 40)	D (1.0)
< 20	F (0)

4. MinEC: Minimum Edge Contrast

Checks if the contrast between adjacent bars and spaces is high enough. If the difference between the light and dark elements is not significant, barcode readers fail to locate edges between bars and spaces.

Note: MinEC finds the worst-case contrast difference between each bar to space transition, whereas symbol contrast finds the best-case difference at any point across the barcode.

5. MOD: Modulation

Modulation checks the edge contrast as a fraction of the overall or best case contrast measured in symbol contrast. Modulation is a measure of minimum edge contrast since most barcode readers employ adaptive thresholding circuits to detect transitions between bars and spaces. If all bars and spaces were the same brightness, the minimum edge contrast would be equivalent to the symbol contrast, resulting in 100% modulation. If some spaces are less bright than the brightest one, modulation is some fraction of the overall contrast. Modulation therefore measures the amount of available contrast that is manifested in the worst-case bar to space transition. The percentage is assigned a letter grade.

Excessive ink spread or bar growth can result in low modulation because very narrow spaces appear to be filled in by the encroaching bars in the Scan Reflectance Profile.

MOD %	Grade
≥ 70	A (4.0)
≥ 60 (but less than 70)	B (3.0)
≥ 50 (but less than 60)	C (2.0)
≥ 40 (but less than 50)	D (1.0)
< 40	F (0)

6. Def: Defects

The worst-case change in reflectance within a single bar or space is a defect. The largest difference in reflectivity found in a single bar or space is measured as a percentage of the symbol contrast and assigned a letter grade. Defects measure breakups or voids within bars, ink spots in spaces, or even the grain of a substrate in spaces.

Def %	Grade
≤ 15	A (4.0)
≤ 20 (but greater than 15)	B (3.0)
≤ 25 (but greater than 20)	C (2.0)
≤ 30 (but greater than 25)	D (1.0)
> 30	F (0)

7. DCD: Decode

The widths of each bar and space are measured and used to interpret the data content of the barcode according to a specific mathematical formula appropriate for the barcode type. If the barcode cannot be decoded according to the formula, the accuracy of the bar and space widths are inadequate. The printout shows the number of scans decoded over the number of scans taken, for example 8/10 means 8 out of 10 scans decoded.

8. DEC: Decodability

Determines how accurate the bar and space widths are and how easily the widths can be determined. A perfectly accurate barcode has 100 percent decodability, but decodability as low as 25 percent is often acceptable. Decodability is the percentage of the overall tolerance range for a bar or space width that is not used up by inaccuracies.

DEC %	Grade
≥ 62	A (4.0)
≥ 50 (but less than 62)	B (3.0)
≥ 37 (but less than 50)	C (2.0)
≥ 25 (but less than 37)	D (1.0)
< 25	F (0)

9. QZ: Quiet Zone

Quiet Zone refers to a dedicated amount of blank space on the left and right of the barcode. Each symbology specifies a minimum quiet zone.

Using Your DataMan 475 Verifier

This section provides information on the installation process of the DataMan Setup Tool, troubleshooting Ethernet connection issues, tuning, image filtering, as well as reader training and package detection.

Reading your first Code

Follow the steps below to install and connect your reader to the DataMan Setup Tool:

1. Check the DataMan **Release Notes** for a full list of system requirements found at C:\Program Files (x86)\Cognex\DataMan\DataMan Software v6.1.8\Documentation\English.
2. Download the latest version of the DataMan Setup Tool from <http://www.cognex.com/support/dataman> and follow the on-screen steps.
3. Connect the DataMan 475 verifier to your PC using the x-coded Ethernet cable and power the reader using the breakout cable.
4. Launch the DataMan Setup Tool and click **Refresh**.

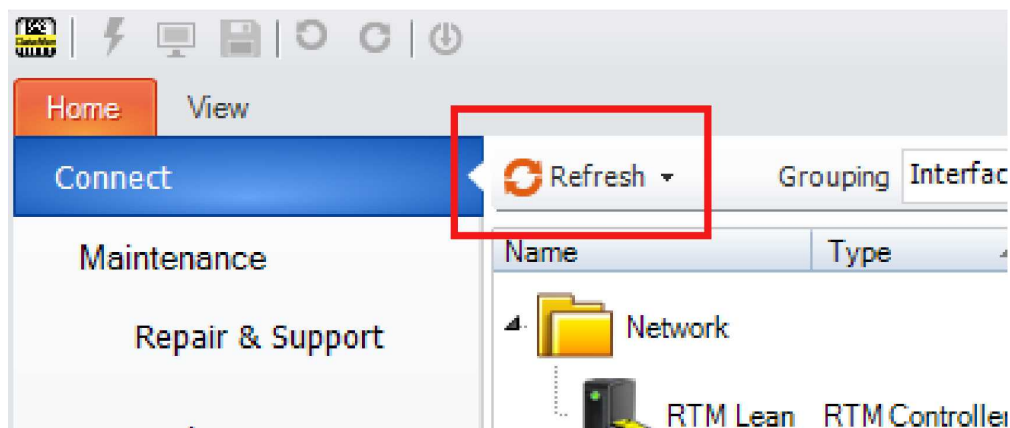

Note: Detected readers appear under **COM ports** or **Network devices**, or both.

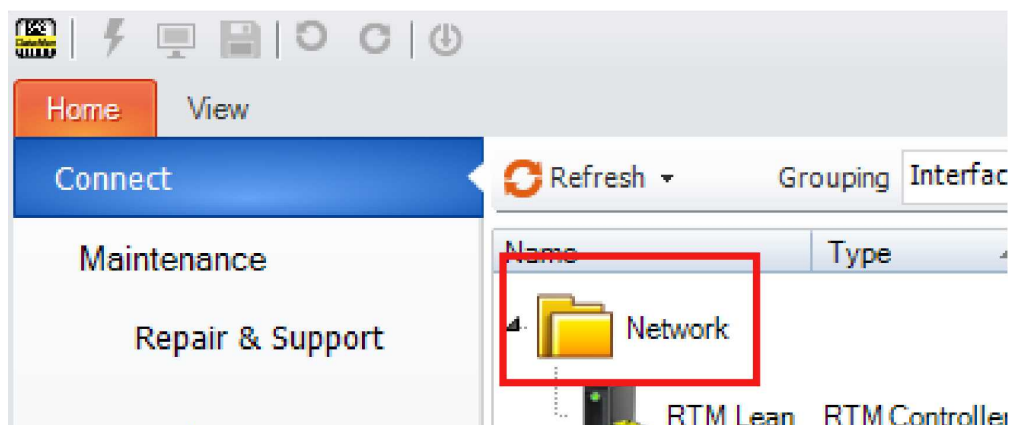

If the reader does not appear, you can use either the **Add Device** or **Force Network Settings** options in the DataMan Setup Tool under **Repair & Support**. For more information, see the DataMan *Setup Tool Reference Manual*.

5. Select a verifier from the list and double click it or click **Connect**.

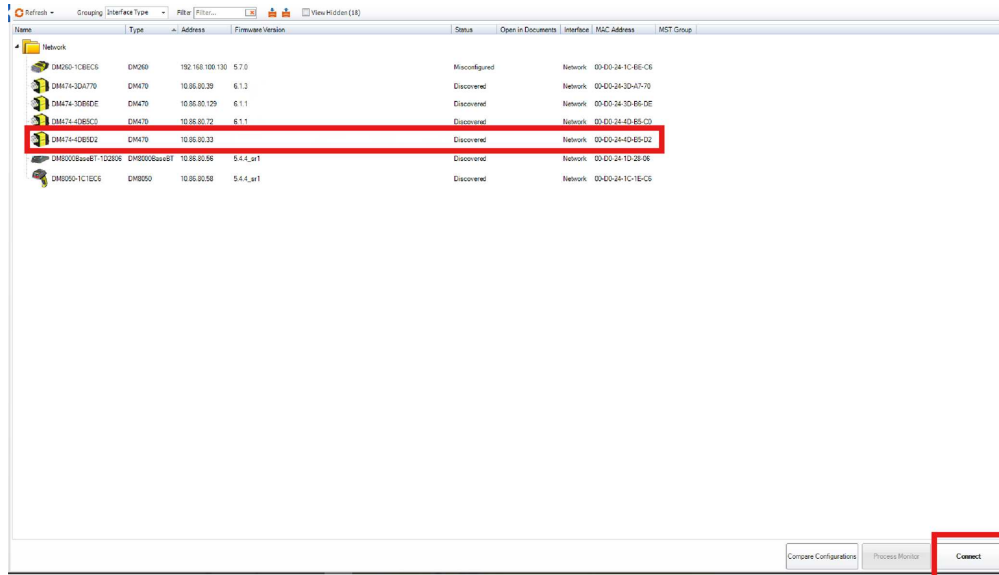

6. After connecting, the TruCheck window automatically opens.

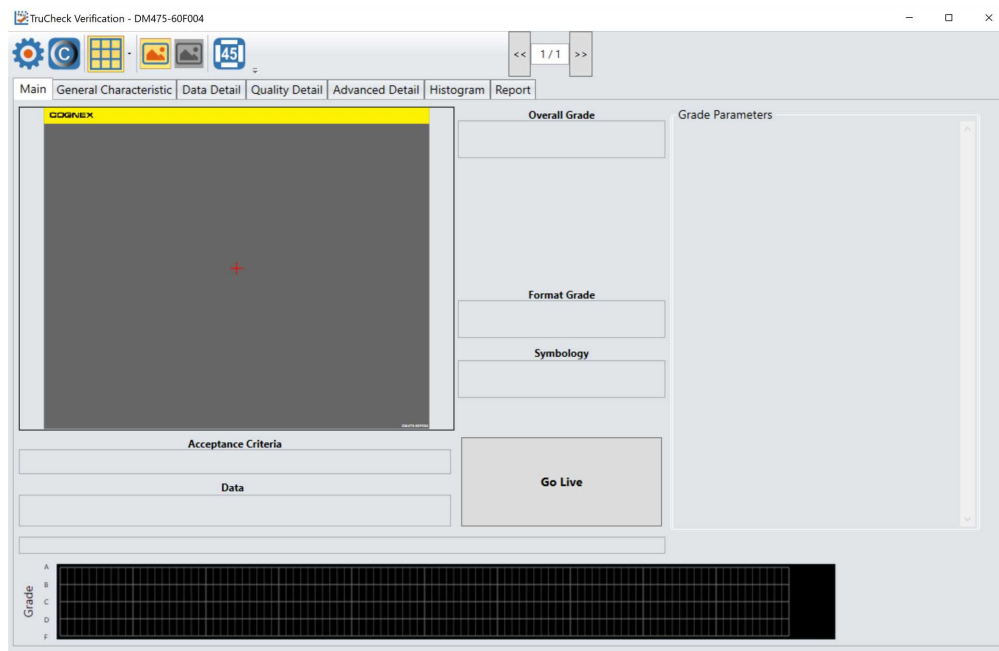

Note: If TruCheck does not open or needs to be re-opened at any point during verification, select the TruCheck window icon under the **View** tab in Setup Tool.

Note: If you are running the DM475V at line speed, you may need to disconnect Setup Tool and obtain results through the device output interface.

WARNING: Do not stare into the beam when adding, removing, or changing cables. Cognex recommends to disconnect the reader from power whenever you make physical changes to it.

Follow the steps below to connect your reader to power and network:

CAUTION: I/O wiring or adjustments to I/O devices should be performed when the verifier is not receiving power.

CAUTION: The Ethernet cable shield must be grounded at the far end. Whatever this cable is plugged into (usually a switch or router) should have a grounded Ethernet connector. A digital voltmeter should be used to validate the grounding. If the far end device is not grounded, a ground wire should be added in compliance with local electrical codes.

1. Connect the I/O+RS232+24V cable to your reader.
2. Connect your reader through an Ethernet cable to your network for a network connection.
3. Connect the cable to a 24V power supply.

External Triggers

If you are using external triggering, you can use any of the following methods to trigger your DataMan 475 verifier:

- Press the trigger button on the reader.
- Send a pulse on the I/O cable:
 - Trigger + (orange or red)
 - Trigger - (black)
- Send a serial trigger command over the RS-232 connection or Ethernet connection.
- Press <CTRL-T> on the keyboard while the DataMan Setup Tool has the input focus.
- Click the **Trigger** button in the DataMan Setup Tool:

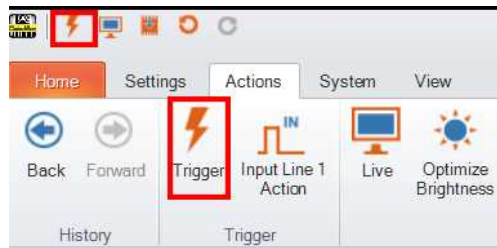

Cleaning and Maintenance

Cleaning the Verifier Housing

To clean the outside of the verifier housing, use a small amount of mild detergent cleaner or isopropyl alcohol on a cleaning cloth. Do not pour the cleaner directly onto the verifier housing.

 **CAUTION:** Do not attempt to clean any DataMan product with harsh or corrosive solvents, including lye, methyl ethyl ketone (MEK) or gasoline.

Cleaning the Verifier Lens Cover

To remove dust from the lens cover, use a pressurized air duster. The air must be free of oil, moisture or other contaminants that could remain on the lens cover. To clean the plastic window of the lens cover, use a small amount of isopropyl alcohol on a cleaning cloth. Do not scratch the plastic window. Do not pour the alcohol directly on the plastic window.

Compliance Information, Warnings and Notices

Precautions

To reduce the risk of injury or equipment damage, observe the following precautions when you install the Cognex product:

- The verifier is intended to be supplied by a UL or NRTL listed power supply with a 24VDC output rated for at least 2A continuous and a maximum short circuit current rating of less than 8A and a maximum power rating of less than 100VA and marked Class 2 or Limited Power Source (LPS). Any other voltage creates a risk of fire or shock and can damage the components. Applicable national and local wiring standards and rules must be followed.
- Route cables and wires away from high-current wiring or high-voltage power sources to reduce the risk of damage or malfunction from the following causes: over-voltage, line noise, electrostatic discharge (ESD), power surges, or other irregularities in the power supply.
- Do not install Cognex products where they are exposed to environmental hazards such as excessive heat, dust, moisture, humidity, impact, vibration, corrosive substances, flammable substances, or static electricity.
- Do not expose the image sensor to laser light. Image sensors can be damaged by direct, or reflected, laser light. If your application requires laser light that might strike the image sensor, use a lens filter at the corresponding laser wavelength. For suggestions, contact your local integrator or application engineer.
- Changes or modifications not expressly approved by the party responsible for regulatory compliance could void the user's authority to operate the equipment.
- Include service loops with cable connections.
- Ensure that the cable bend radius begins at least six inches from the connector. Cable shielding can be degraded or cables can be damaged or wear out faster if a service loop or bend radius is tighter than 10X the cable diameter.
- This device should be used in accordance with the instructions in this manual.
- All specifications are for reference purposes only and can change without notice.

Regulations/Conformity

Note: For the most current CE declaration and regulatory conformity information, see the Cognex support site: cognex.com/support.

DataMan 475 verifiers have Regulatory Model and meet or exceed the requirements of all applicable standards organizations for safe operation. However, as with any electrical equipment, the best way to ensure safe operation is to operate them according to the agency guidelines that follow. Please read these guidelines carefully before using your device.

Safety and Regulatory	
Manufacturer	Cognex Corporation One Vision Drive Natick, MA 01760 USA
USA	TÜV SÜD SCC/NRTL OSHA Scheme for UL/CAN 61010-1. FCC Part 15, Class A This equipment has been tested and found to comply with the limits for a Class A digital device, pursuant to part 15 of the FCC Rules. These limits are designed to provide reasonable protection against harmful interference when the equipment is operated in a commercial environment. This equipment generates, uses, and can radiate radio frequency energy and, if not installed and used in accordance with the instruction manual, may cause harmful interference to radio communications. Operation of this equipment in a residential area is likely to cause harmful interference in which case the user will be required to correct the interference at his own expense.
Canada	TÜV SÜD SCC/NRTL OSHA Scheme for UL/CAN 61010-1. ICES-003, Class A This Class A digital apparatus complies with Canadian ICES-003. Cet appareil numérique de la classe A est conforme à la norme NMB-003 du Canada.
Europe	The CE mark on the product indicates that the system has been tested to and conforms to the provisions noted within the 2014/30/EU Electromagnetic Compatibility Directive and the 2011/65/EU RoHS Directive. For further information, please contact: Cognex Corporation, One Vision Drive, Natick, MA 01760, USA. Cognex Corporation shall not be liable for use of our product with equipment (i.e., power supplies, personal computers, etc.) that is not CE.
Korea	A급 기기(업무용 방송통신기자재): 이 기기는 업무용(A급) 전자파적합기기로서 판매자 또는 사용자는 이 점을 주의하시기 바라며, 가정외의 지역에서 사용하는 것을 목적으로 합니다.
International Product Safety	Conforms to IEC 61010-1, CAN/CSA-C22.2 No. 61010-1:2012 + UPD No. 1:2015-07, UL 61010-1:2012 + R:2015-07, UL 61010-1:2012 + R:2015-07, EN 61010-1:2010.
CB	TÜV SÜD IEC/EN 61010-1. CB report available upon request.

For European Community Users

Cognex complies with Directive 2012/19/EU OF THE EUROPEAN PARLIAMENT AND OF THE COUNCIL of 4 July 2012 on waste electrical and electronic equipment (WEEE).

This product has required the extraction and use of natural resources for its production. It may contain hazardous substances that could impact health and the environment, if not properly disposed.

In order to avoid the dissemination of those substances in our environment and to diminish the pressure on the natural resources, we encourage you to use the appropriate take-back systems for product disposal. Those systems will reuse or recycle most of the materials of the product you are disposing in a sound way.



The crossed out wheeled bin symbol informs you that the product should not be disposed of along with municipal waste and invites you to use the appropriate separate take-back systems for product disposal.

If you need more information on the collection, reuse, and recycling systems, please contact your local or regional waste administration.

You may also contact your supplier for more information on the environmental performance of this product.

Reader Programming Codes



Reset Scanner to Factory Defaults



Reboot Scanner

