

# COGNEX

## DataMan<sup>®</sup> 360 Series Quick Reference Guide

2020 August 13  
Revision: 6.1.9.1

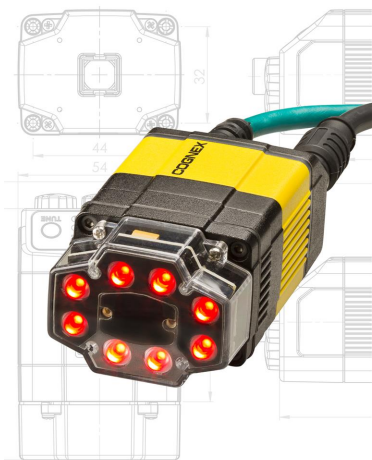

# Precautions



**WARNING: LASER LIGHT, DO NOT STARE INTO BEAM: CLASS 2 LASER PRODUCT. FAILURE TO FOLLOW THESE INSTRUCTIONS MAY CAUSE SERIOUS INJURY**

- CAUTION - Use of controls or adjustments or performance of procedures other than those specified herein may result in hazardous radiation exposure.
- Do not attempt to service or repair this product -- return it to Cognex for service.
- Do not permit anyone other than Cognex Corporation to service, repair, or adjust this product.
- Do not attempt to open or modify this device except as described in this document.
- Do not direct or reflect laser light toward people or reflective objects.
- Do not operate this device if it is damaged or if the covers or seals are missing or damaged.
- IP protection is ensured only when all connectors are attached to cables or shielded by a sealing cap.

This Laser Product is designated as Class 2 during all procedures of operation.

Wavelength	650 nm
Laser Power for classification	< 1mW
Beam Diameter	< 3mm at aperture
Divergence	< 1.5 mrad

# Symbols

The following symbols indicate safety precautions and supplemental information:



**WARNING:** This symbol indicates a hazard that could cause death, serious personal injury or electrical shock.

---



**CAUTION:** This symbol indicates a hazard that could result in property damage.

---



**Note:** This symbol indicates additional information about a subject.

---



**Tip:** This symbol indicates suggestions and shortcuts that might not otherwise be apparent.

---

# Product Overview

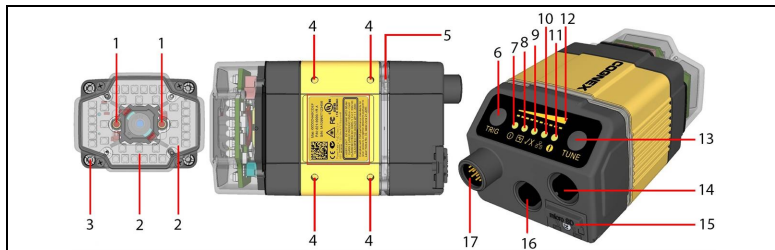





1	Laser aimer
2	Illumination LED clusters
3	External illumination mounting point
4	Mounting holes (M3 x 5 mm)
5	Indicator light ring
6	Trigger button
7	Power
8	Train status
9	Read/no-read indicator
10	Network
11	Error
12	Peak meter
13	Tuning button
14	Ethernet
15	SD card slot
16	External light control
17	Power, I/O, and RS232

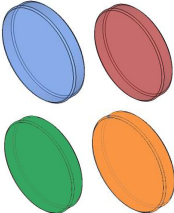

# DataMan 360 Accessories

## LENS OPTIONS AND COVERS

<p>10.3 mm M12 lens with locking 10.3 mm IR M12 lens with locking</p>	<p>DM300-LENS-10 DM300-LENS-10-IR</p>	
<p>Liquid lens module and pre-focused 10.3 mm or 10.3 mm IR M12 lens with wrench</p>	<p>DM300-LENS-10LL DM300-LENS-10LL-IR</p>	
<p>19 mm liquid lens module</p>	<p>DM300-LENS-19LL</p>	
<p>16 mm M12 lens with locking without built-in IR blocking filter</p>	<p>DM300-LENS-16</p>	

8 mm F5.6 fixed aperture lens	LEC-CFF08-F5.6	
12 mm F8 fixed aperture lens	LEC-CFF12-F8	
16 mm F8 fixed aperture lens	LEC-CFF16-F8	
16 mm F11 fixed aperture lens	LEC-CFF16-F11	
25 mm F8 fixed aperture lens	LEC-CFF25-F8	
25 mm F11 fixed aperture lens	LEC-CFF25-F11	
35 mm F8 fixed aperture lens	LEC-CFF35-F8	
35 mm F11 fixed aperture lens	LEC-CFF35-F11	
35 mm F16 fixed aperture lens	LEC-CFF35-F16	
40 mm F11 fixed aperture lens	LEC-CFF40-F11	
40 mm F16 fixed aperture lens	LEC-CFF40-F16	
24 mm F6 liquid lens module with built-in IR blocking filter	DM360-LENS-24LL	
25 mm M12 lens with lens spacer and hex wrench (also requires Extension kit)	DM300-LENS-25	
Extension kit	DM300-EXT	
DM500 C-Mount cover (use with HPIA)	DM500-CMTLC-000	

DM500 Lens cover extender	DM500-LNSEXT-000	
Blue, red, green, orange bandpass filters	CKR-BP470 CKR-BP635 CKR-BP525 CKR-BP590	
Clear lens cover	DM300-CLCOV	
Clear lens cover with white LED illumination (Risk Group Exempt acc. IEC 62471)	DM300-CLCOV-WHI	
Diffuse lens cover with red LED illumination, with blue LED illumination, with IR LED illumination, Polarizer lens cover with red LED illumination (Risk Group Exempt acc. IEC 62471)	DM300-DLCOV-RE DM300-DLCOV-BL DM300-DLCOV-IR DM300-PLCOV-RE	
Diffuse lens cover, red illumination (assembled), ESD safe (Risk Group Exempt acc. IEC 62471)	DM300-DLCOV-RE-ESD	

Red LED high-powered integrated light, 10.3 mm lens (Risk Group Red LED Exempt acc. IEC 62471, Risk Group Green LED Amer Exempt acc. IEC 62471)	DM360-HPIL-RE	
Polarized red LED high-powered integrated light, ESD safe, 10.3 mm lens (Risk Group Red LED Exempt acc. IEC 62471, Risk Group Green LED Amer Exempt acc. IEC 62471)	DM360-HPIL-RE-P	
White LED high-powered integrated light, 10.3 mm lens (Risk Group White LED low risk acc. IEC 62471, Risk Group Green LED Amer Exempt acc. IEC 62471)	DM360-HPIL-WHI	
Red LED high-powered integrated light, 24 mm lens (Risk Group Red LED Exempt acc. IEC 62471)	DMLT-HPIL-RE	
Polarized red LED high-powered integrated light, 24 mm lens (Risk Group Green LED Amer Exempt acc. IEC 62471)	DMLT-HPIL-RE-P	
White LED high-powered integrated light, 24 mm lens (Risk Group White LED low risk acc. IEC 62471, Risk Group Green LED Amer Exempt acc. IEC 62471)	DMLT-HPIL-WHI	
C-Mount cover for C-Mount lenses	DM300-CMCOV	
Short C-Mount cover for C-Mount lenses	DM300-CMCOV-SH	







## EXTERNAL LIGHTS (RED LED) AND HIGH POWER ILLUMINATIONS







Ring Light	CLRR-R7030G1CLR	
------------	-----------------	---

Back light	CLRB-F100100G1	
Coaxial (DOAL) light	CLRO-K5050G1	
Spot light	CLRS-P14G1	
Dark-field light	CLRD-D120G1	
Bar light, blue	IVSL-LX520-470	
Bar light, red	IVSL-LX520-625	
HPIA, Red narrow	DM30X-HPIA3-625	
HPIA, Red wide	DM30X-HPIA3-625-W	
HPIA, Red narrow with polarizer	DM30X-HPIA3-625P	
HPIA, Red wide with polarizer	DM30X-HPIA3-625P-W	
HPIA, White narrow	DM30X-HPIA3-WHI	
HPIA, White wide	DM30X-HPIA3-WHI-W	
HPIA, Blue narrow	DM30X-HPIA3-470	
HPIA, Blue wide	DM30X-HPIA3-470-W	
HPIA, Infrared narrow	DM30X-HPIA3-IR	
HPIA, Infrared wide	DM30X-HPIA3-IR-W	

Red narrow	DM30X-HPIA-625	
Red wide	DM30X-HPIA-625-W	
Red narrow with polarizer	DM30X-HPIA-625P	
White narrow	DM30X-HPIA-WHI	
White wide	DM30X-HPIA-WHI-W	
Blue narrow	DM30X-HPIA-470	
Blue wide	DM30X-HPIA-470-W	
Infrared narrow	DM30X-HPIA-IR	
Infrared wide	DM30X-HPIA-IR-W	

## OTHER

Connection cable 24V, I/O, RS-232 (y straight/angled, xx specifies length)	CCB-M12x12FIy-xx	
Connection cable 24V, I/O, RS-232	CCBL-05-01	
Power and I/O breakout cable, M12-12, straight, xx specifies length: 5m, 10m, 15m, angled, xx specifies length: 5m, 10m, 15m	CCB-PWRIO- xx CCB-PWRIO-xxR	
Connection cable RS-232	CCB-M12xDB9Y-05	
Power cable for multiple bar lights (use in combination with IVSL-5PM12-5)	CCB-FOV25-MAL-012	
Ethernet M12 to RJ45 cable (y=1: straight / y=6: angled, x-xx specifies length)	CCB-84901-y00x-xx	
External light cable (xxx specifies length) Only compatible with CLRR / CLRB / CLRO / CLRS / CLRD illumination	CCB-M12x4MS-xxx	
Bar light cable (xxx specifies length: 300, 500, 1000, 2000 mm) Compatible with IVSL lights, except IVSL-LX280	IVSL-5PM12-Jxxx	
I/O extension cable, 5m straight	CKR-200-CBL-EXT	

Laser aimer (use with HPIA)	DM300-AIMER-00	
Connection module (4 or 1 camera) (xx can be US, EU, UK or JP)	DMA-CCM-4X-xx or DMA-CCM-1-xx	 
External light mounting brackets (xx specifies light type) (may get used in combination with DM100-PIVOTM-00 or DM500-BRKT-000 if pivoting is required)	DM300-ELMB-xx	   
Universal Mounting Bracket	DM100-UBRK-000	
Pivot Mounting Bracket	DM100-PIVOTM-00	

# Dimensions

A	S-Mount (M12) Lens version
B	C-Mount Lens version

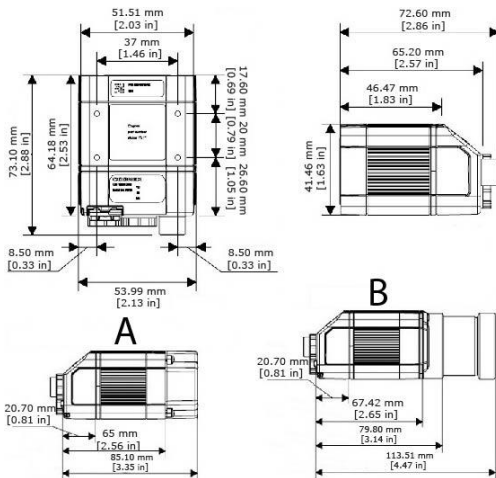

# Field of View and Reading Distances

**Note:** Due to tolerances, ranges can vary by +/- 5 % from unit to unit.

10.3 mm lens (green)	16 mm lens (red)	25 mm lens (blue)
inner: DM360	inner: DM360	inner: DM360
outer: DM362, DM363	outer: DM362, DM363	outer: DM362, DM363

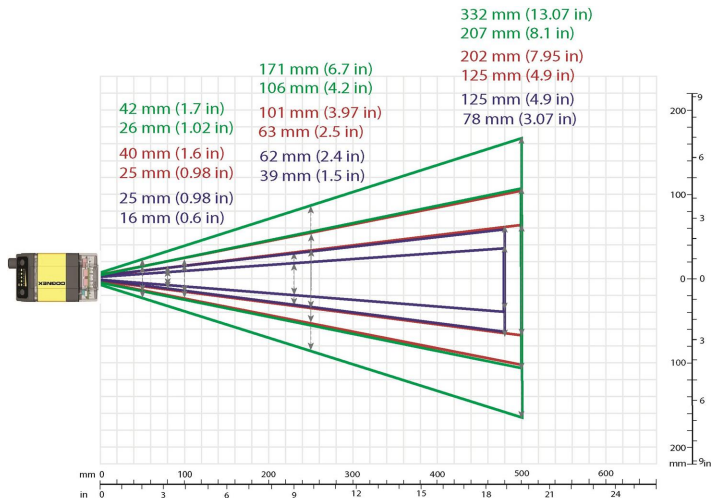

Device	Distances in mm/2D min. code 10.3 mm lens		Distances in mm/1D min. code 10.3 mm lens	
DM360, DM362	0-75	5 MIL	0-215	7 MIL
	0-210	10 MIL	0-409	13 MIL
	0-374	20 MIL	0-500	18 MIL
DM363	20-110	5 MIL	20-350	7 MIL
	15-325	10 MIL	25-735	13 MIL
	10-580	20 MIL	25-840	18 MIL

Device	Distances in mm/2D min. code 16 mm lens		Distances in mm/1D min. code 16 mm lens	
DM360, DM362	59-72	2 MIL	60-125	2 MIL
	55-207	4 MIL	55-270	4 MIL
	49-295	8 MIL	56-400	6 MIL
DM363	35-190	5 MIL	45-400	7 MIL
	30-420	10 MIL	45-495	13 MIL
	25-500	20 MIL	45-540	18 MIL

Device	Distances in mm/2D min. code 25 mm lens		Distances in mm/1D min. code 25 mm lens	
DM360, DM362	100-155	2 MIL	95-155	2 MIL
	95-350	4 MIL	92-350	4 MIL
	90-470	8 MIL	88-380	6 MIL
DM363	95-155	2 MIL	95-155	2 MIL
	90-350	4 MIL	92-360	4 MIL
	88-385	8 MIL	90-390	6 MIL

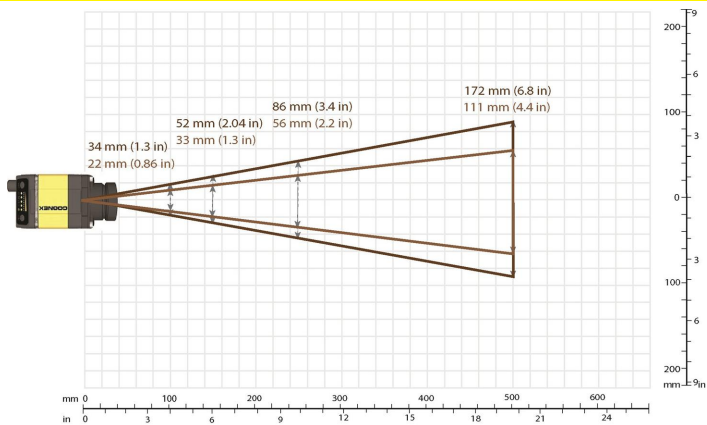

Device	Distances in mm/2D min. code 19 mm lens		Distances in mm/1D min. code 19 mm lens	
	DM360 (inner, brown), DM362 (outer, black)	61-97	2 MIL	59-173
58-167		4 MIL	56-322	4 MIL
58-310		8 MIL	56-471	6 MIL
DM363 (outer, black)	61-109	2 MIL	29-199	2 MIL
	58-192	4 MIL	56-375	4 MIL
	58-361	8 MIL	56-551	6 MIL

24 mm lens, DM363: green

24 mm lens, DM362: brown

24 mm lens, DM360: red

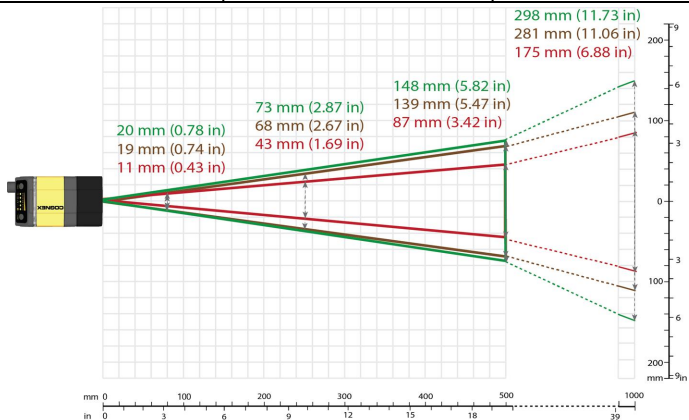

Device	Distances in mm/2D min. code 24 mm lens		Distances in mm/1D min. code 24 mm lens	
DM360, DM362	80-120	2 MIL	80-230	2 MIL
	80-230	4 MIL	80-460	4 MIL
	80-460	8 MIL	80-690	6 MIL
DM363	80-150	2 MIL	80-270	2 MIL
	80-300	4 MIL	80-540	4 MIL
	80-600	8 MIL	80-810	6 MIL

# Connecting the Reader

**CAUTION:** The Ethernet cable shield must be grounded at the far end. Whatever this cable is plugged into (usually a switch or router) should have a grounded Ethernet connector. A digital voltmeter should be used to validate the grounding. If the far end device is not grounded, a ground wire should be added in compliance with local electrical codes.



**CAUTION:** To reduce emissions, connect the far end of the Breakout cable shield to frame ground.

Perform the following steps:

1. Mount the reader.
2. Connect the Ethernet cable to a computer or a switch.
3. Connect the breakout cable to a 24 V power supply.

For information on the cable pinout and wire colors, see section *Connections, Optics, and Lighting* in the *DataMan 360 Reader Reference Manual*.

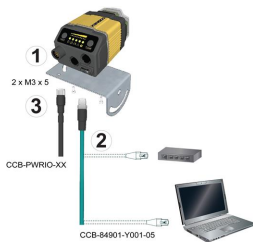

# Installation

Installation procedures and specifications are presented in detail in the *DataMan 360 Series Reader Reference Manual*, which is installed with the DataMan Setup Tool. From the Windows Start menu, select the following to access the manual: *All Programs > Cognex > DataMan Software vx.x.x > Documentation*.

---

**Note:**

- Cables are sold separately.
- If a standard component is missing or damaged, immediately contact your Cognex Authorized Service Provider (ASP) or Cognex Technical Support.



**CAUTION:** All cable connectors are "keyed" to fit the connectors on the DataMan system; do not force the connectors or damage may occur.

---

# Mounting



**CAUTION:** It is recommended the reader be grounded, either by mounting the reader to a fixture that is electrically grounded or by attaching a wire from the reader's mounting fixture to frame ground or Earth ground. If a ground wire is used, it should be attached to one of the four mounting points on the back plate of the reader; not to the mounting points on the front of the reader.

Mounting the DataMan reader at a slight angle ( $15^{\circ}$ ) can reduce reflections and improve performance.

Use the set of mounting holes on the bottom part to mount the DataMan reader.



For more information on mounting, see the *DataMan 360 ReaderSeries Reference Manual*.

## Connect the Ethernet Cable

---

**CAUTION:** The Ethernet cable shield must be grounded at the far end.



Whatever this cable is plugged into (usually a switch or router) should have a grounded Ethernet connector. A digital voltmeter should be used to validate the grounding. If the far end device is not grounded, a ground wire should be added in compliance with local electrical codes.

---

1. Connect the Ethernet cable's M12 connector to the DataMan system's ENET connector.
2. Connect the Ethernet cable's RJ-45 connector to a switch/router or PC, as applicable.

## Connect the Breakout Cable

---



**CAUTION:** To reduce emissions, connect the far end of the Breakout cable shield to frame ground.

---

### Note:



- I/O wiring or adjustments to I/O devices should be performed when the reader is not receiving power.
- You can clip unused wires short or use a tie made of non-conductive material to tie them back. Keep bare wires separated from the +24 VDC wire.

1. Verify that the 24 VDC power supply is unplugged and not receiving power.
2. Attach the Breakout cable's +24 VDC and Ground to the corresponding terminals on the power supply.



**CAUTION:** Never connect voltages other than 24 VDC. Always observe the polarity shown.

---

3. Attach the Breakout cable's M12 connector to the DataMan 360 series reader's 24 VDC connector.
4. Restore power to the 24 VDC power supply and turn it on if necessary.

# Install Software and Documentation and Connect the Reader

Follow the steps below to connect your reader to power and network:

1. Connect the I/O+RS232+24V cable to your reader.
2. For a network connection, connect your reader through an Ethernet cable to your network.
3. Connect the cable to a 24V power supply.

To configure a DataMan 360 series reader, the DataMan Setup Tool software must be installed on a networked PC. The DataMan Setup Tool is available from the DataMan support site: <http://www.cognex.com/support/dataman>.

1. After installing the software, connect the DataMan 360 series reader to your PC.
2. Launch the DataMan Setup Tool and click **Refresh**.
3. Select your DataMan 360 series reader from the list and click **Connect**.

# DataMan 360 Series Specifications

Specification	DataMan 360 Reader			
Weight	165 g			
Operating Temperature	0°C — 40°C (+32°F — 104°F) 0°C — 50°C (+32°F — 122°F)			
Storage Temperature	-10°C — +60°C (+14°F — +140°F)			
Maximum Humidity	< 95% (non-condensing)			
Environmental	IP65 (with cable or protection cap attached to all connectors, front cover properly installed)			
LED Safety	IEC62471: red illumination: Exempt Risk Group, blue and white illuminations: Risk Group 1 (Low-Risk). No further labeling is required.			
RS-232	RxD, TxD according to TIA/EIA-232-F			
Codes	<b>1-D barcodes:</b> Codabar, Code 39, Code 128, and Code 93, Interleaved 2 of 5, MSI, Pharma, GS1 DataBar, Postal, UPC/EAN/JAN <b>2-D codes:</b> Data Matrix™ (IDMax and IDQuick: ECC 0, 50, 80, 100, 140, and 200), QR Code and microQR Code, MaxiCode, DotCode, Aztec Code, RSS/CS <b>Stacked codes:</b> PDF 417, MicroPDF 417			
Discrete I/O operating limits	HS Output 0,1,2,3	$I_{MAX}$		50 mA
		$R_{MIN}$	@ 12 VDC	200 Ω
	Input 0 (Trigger)	$V_{IH}$	±15 — ±28 V	
	Input 1,2,3	$V_{IL}$	0 — ±5 V	
		$I_{TYP}$	@ 12 VDC	2.0 mA
			@ 24 VDC	4.2 mA

Specification	DataMan 360 Reader
Power Supply Requirements	24 V +/- 10% Options: <ul style="list-style-type: none"> <li>• Internal illumination (non-HPIL*): 250 mA maximum, 5 W</li> <li>• Internal illumination (HPIL*): 2.2 A maximum, 6 W</li> <li>• External illumination: up to 1.2 A average, 45 W, peak current according to illumination, these values depend on the illumination and its configuration</li> </ul> Supplied by LPS or NEC class 2 only *HPIL denotes one of the DM360-HPIL-RE or DM360-HPIL-RE-P accessories
Light Connector	Current load up to 1.05 A average
Ethernet Speed	10/100
Duplex Mode	Full duplex or half duplex

# DataMan 360 Series Imager Specifications

Specification	DataMan 360 Series Imager
Image Sensor	1/1.8 inch CMOS
Image Sensor Properties	6.9 mm x 5.5 mm (H x V); 5.3 $\mu\text{m}$ square pixels (DataMan 360 and 362), 4.5 $\mu\text{m}$ square pixels (DataMan 363)
Image Resolution (pixels)	<ul style="list-style-type: none"><li>• DataMan 360: 800 x 600</li><li>• DataMan 362: 1280 x 1024</li><li>• DataMan 363: 1600 x 1200</li></ul>
Electronic Shutter Speed	<ul style="list-style-type: none"><li>• minimum exposure: 5 <math>\mu\text{s}</math> (DataMan 360 and 362), 12 <math>\mu\text{s}</math> (DataMan 363)</li><li>• maximum exposure: 1000 <math>\mu\text{s}</math> with internal illumination/100000 <math>\mu\text{s}</math> with external illumination</li></ul>
Image Acquisition at Full Resolution	<ul style="list-style-type: none"><li>• DataMan 360 and 362: up to 60 fps</li><li>• DataMan 363: up to 40 fps</li></ul>
Lens Type	<ul style="list-style-type: none"><li>• S-Mount 10.3 mm F:5 (with optional liquid lens) with IR blocking filter</li><li>• S-Mount 16 mm F:9, no IR blocking filter</li><li>• C-Mount 24 mm F:6 (with liquid lens only) with IR blocking filter</li><li>• S-Mount 25 mm M12 lens, no IR blocking filter</li><li>• C-Mount lenses (with limitations, see below)</li></ul>

## Limitations to C-Mount lenses:

- The length of the thread may not exceed 5.4 mm.
- For a chosen lens, the distance from the C-mount shoulder to the bottom of the lens may not exceed 5.4 mm. Possibly a lens spacer is required.
- When using the C-Mount lens cover, lens dimensions including spacer and filters may not exceed 32 x 42 mm (diameter x length).

To avoid accelerated aging of built-in illumination LEDs, which results in light intensity degradation, consider the following duty cycle limits above 25°C (77 °F):

- at 35 °C (95 °F): 4% duty cycle, for example, 750 µs exposure and 18493 µs interval
- at 45 °C (113 °F): 2% duty cycle, for example, 350 µs exposure and 18093 µs interval or 1000 µs exposure and 50000 µs interval

## LED Wavelengths





The following table shows LED types and the related peak wavelengths:

LED	$\lambda$ [nm]
WHITE	6500K (Color Temperature)
BLUE	470
RED	617
HIGH POWER RED	617
IR	850

# Regulations/Conformity

DataMan 360 and 362 readers have Regulatory Model 1AA4, DataMan 363 readers have Regulatory Model 1ABG and meet or exceed the requirements of all applicable standards organizations for safe operation. However, as with any electrical equipment, the best way to ensure safe operation is to operate them according to the agency guidelines that follow. Please read these guidelines carefully before using your device.

Regulator	Specification
Manufacturer	Cognex Corporation One Vision Drive Natick, MA 01760 USA
USA	FCC Part 15, Class A FDA/CDRH Laser Notice No 50
Canada	ICES-003, Class A
European Community	EN55022, Class A
	EN55024 EN60950
	EN60825-1
Korea	MSIP-REM-CGX-DM360 KN32, KN35

<b>Safety and Regulatory</b>	
European Compliance 	<p><b>WARNING:</b> This is a class A product. In a domestic environment this product may cause radio interference in which case the user may be required to take adequate measures.</p> <p>The CE mark on the product indicates that the system has been tested to and conforms to the provisions noted within the 2014/30/EU Electromagnetic Compatibility Directive. For further information please contact: Cognex Corporation, One Vision Drive, Natick, MA 01760, USA. Cognex Corporation shall not be liable for use of our product with equipment (i.e., power supplies, personal computers, etc.) that is not CE.</p>
FCC Class A Compliance Statement 	<p>This equipment has been tested and found to comply with the limits for a Class A digital device, pursuant to Part 15 of the FCC rules. These limits are designed to provide reasonable protection against harmful interference when the equipment is operated in commercial environment. This equipment generates, uses, and can radiate radio frequency energy and, if not installed and used in accordance with the instructions, may cause harmful interference to radio communications. Operation of this equipment in a residential area is likely to cause harmful interference, in which case the user will be required to correct the interference at personal expense.</p>
Canadian Compliance 	<p>This Class A digital apparatus complies with Canadian ICES-003. Cet appareil numérique de la classe A est conforme à la norme NMB-003 du Canada.</p>
C-Tick Statement 	<p>Conforms to AS/NZS CISPR 22/ EN 55022 for Class A Equipment.</p>
UL and cUL Statement 	<p>UL and cUL listed: UL60950-1 2nd ed. and CSA C22.2 No.60950-1 2nd ed.</p>

## Laser Safety Statement



Compliance with FDA performance standards for laser products except for deviations pursuant to Laser Notice No. 50, dated June 24, 2007.

This device has been tested in accordance with IEC60825-1 3rd ed., 2014., and has been certified to be under the limits of a Class 2 Laser device.

LASER LIGHT - DO NOT STARE INTO BEAM  
CLASS 2 LASER PRODUCT 650nm <1mW  
CLASSIFIED PER IEC 60825-1, Ed 3, 2014  
CLASSIFIED PER AU/NZS 2211.1 : 2004

Use of controls or adjustments or performance of procedures other than those specified herein may result in hazardous radiation exposure.

## LED Safety Statement

This device has been tested in accordance with IEC62471, and red illumination has been certified to be under the limits of Exempt Risk Group, blue and white illuminations have been certified to be under the limits of Risk Group 1 (Low-Risk). No further labeling is required.

## For European Community Users

Cognex complies with Directive 2012/19/EU OF THE EUROPEAN PARLIAMENT AND OF THE COUNCIL of 4 July 2012 on waste electrical and electronic equipment (WEEE).

This product has required the extraction and use of natural resources for its production. It may contain hazardous substances that could impact health and the environment, if not properly disposed.

In order to avoid the dissemination of those substances in our environment and to diminish the pressure on the natural resources, we encourage you to use the appropriate take-back systems for product disposal. Those systems will reuse or recycle most of the materials of the product you are disposing in a sound way.



The crossed out wheeled bin symbol informs you that the product should not be disposed of along with municipal waste and invites you to use the appropriate separate take-back systems for product disposal.

If you need more information on the collection, reuse, and recycling systems, please contact your local or regional waste administration.

You may also contact your supplier for more information on the environmental performance of this product.

# 中国大陆RoHS (Information for China RoHS Compliance)

根据中国大陆《电子信息产品污染控制管理办法》(也称为中国大陆RoHS), 以下部份列出了本产品中可能包含的有毒有害物质或元素的名称和含量。



Table of toxic and hazardous substances/elements and their content, as required by China's management methods for controlling pollution by electronic information products.

Part Name 部件名称	Hazardous Substances 有害物质					
	Lead (Pb) 铅	Mercury (Hg) 汞	Cadmium (Cd) 镉	Hexavalent Chromium (Cr (VI)) 六价铬	Polybrominated biphenyls (PBB) 多溴联苯	Polybrominated diphenyl ethers (PBDE) 多溴二苯醚
Regulatory Model 1AA4 Regulatory Model 1ABG	X	O	O	O	O	O
<p>This table is prepared in accordance with the provisions of SJ/T 11364. 这个标签是根据SJ/T 11364的规定准备的。</p> <p>O: Indicates that said hazardous substance contained in all of the homogeneous materials for this part is below the limit requirement of GB / T26572 - 2011. 表示本部件所有均质材料中含有的有害物质低于GB / T26572 - 2011的限量要求。</p> <p>X: Indicates that said hazardous substance contained in at least one of the homogeneous materials used for this part is above the limit requirement of GB / T26572 - 2011. 表示用于本部件的至少一种均质材料中所含的有害物质超过GB / T26572 - 2011的限制要求。</p>						

Copyright © 2020  
Cognex Corporation. All Rights Reserved.