

COGNEX

DataMan[®] 8072 DL

Reference Manual



2020 April 14
Revision: 6.1.6SR2.4

Legal Notices

The software described in this document is furnished under license, and may be used or copied only in accordance with the terms of such license and with the inclusion of the copyright notice shown on this page. Neither the software, this document, nor any copies thereof may be provided to, or otherwise made available to, anyone other than the licensee. Title to, and ownership of, this software remains with Cognex Corporation or its licensor. Cognex Corporation assumes no responsibility for the use or reliability of its software on equipment that is not supplied by Cognex Corporation. Cognex Corporation makes no warranties, either express or implied, regarding the described software, its merchantability, non-infringement or its fitness for any particular purpose.

The information in this document is subject to change without notice and should not be construed as a commitment by Cognex Corporation. Cognex Corporation is not responsible for any errors that may be present in either this document or the associated software.

Companies, names, and data used in examples herein are fictitious unless otherwise noted. No part of this document may be reproduced or transmitted in any form or by any means, electronic or mechanical, for any purpose, nor transferred to any other media or language without the written permission of Cognex Corporation.

Copyright © 2019. Cognex Corporation. All Rights Reserved.

Portions of the hardware and software provided by Cognex may be covered by one or more U.S. and foreign patents, as well as pending U.S. and foreign patents listed on the Cognex web site at: cognex.com/patents.

The following are registered trademarks of Cognex Corporation:

Cognex, 2DMAX, Advantage, AlignPlus, Assemblyplus, Check it with Checker, Checker, Cognex Vision for Industry, Cognex VSOC, CVL, DataMan, DisplayInspect, DVT, EasyBuilder, Hotbars, IDMax, In-Sight, Laser Killer, MVS-8000, OmniView, PatFind, PatFlex, PatInspect, PatMax, PatQuick, SensorView, SmartView, SmartAdvisor, SmartLearn, UltraLight, Vision Solutions, VisionPro, VisionView

The following are trademarks of Cognex Corporation:

The Cognex logo, 1DMax, 3D-Locate, 3DMax, BGAll, CheckPoint, Cognex VSoC, CVC-1000, FFD, iLearn, In-Sight (design insignia with cross-hairs), In-Sight 2000, InspectEdge, Inspection Designer, MVS, NotchMax, OCRMax, PatMax RedLine, ProofRead, SmartSync, ProfilePlus, SmartDisplay, SmartSystem, SMD4, VisiFlex, Xpand

Portions copyright © Microsoft Corporation. All rights reserved.

Portions copyright © MadCap Software, Inc. All rights reserved.

Other product and company trademarks identified herein are the trademarks of their respective owners.

Table of Contents

Legal Notices	2
Table of Contents	3
Symbols	5
Getting Started	6
About DataMan 8072 DL	6
DataMan 8072 DL Accessories	7
DataMan 8072 Reader Other	7
DataMan 8072 DL Reader Cables	8
DataMan 8000 Series Base Station Cables	8
Physical Layout of the Reader	9
Physical Layout of the Base Station	10
Setting Up Your DataMan 8072 DL	11
Setting Up the Reader	11
Install the DataMan SetupTool	11
DataMan 8072 DL Specifications	12
DataMan 8072 DL Imager Specifications	12
DataMan Base Station Specifications	12
LED Wavelengths	13
Connection Options	14
Connecting a DataMan 8072 Through Ethernet	14
Troubleshooting an Ethernet Connection	15
Connecting a DataMan 8072 DL Through RS-232	15
Connecting a DataMan 8072 through USB	17
Using Your Device Through USB	18
Using DataMan 8072 Wireless Reader	19
Connecting to a Wireless DataMan 8072 Through a Base Station	19
Pairing Strategy (DMA-IBASE-BT-02)	21
Base Station Routing Capabilities	23
Wireless Reader: Buffering Data	23
Summary of Wireless Buffering Indicators	25
Wireless Reader: Charging	25
Wireless Reader: Changing Batteries	28
Reading Codes with the DataMan 8072 DL	30
Industrial Protocols	30
Trigger Types	31
Field of View and Reading Distances	31
Cleaning and Maintenance	32
Cleaning the Reader Housing	32
Cleaning the Reader Lens Cover	32
Compliance Information, Warnings and Notices	33
Regulations/Conformity	33
Compliance Statements: DataMan Base Station	34
中国大陆 RoHS (Information for China RoHS Compliance)	35

Reader Control Codes **36**
 Keyboard Language (Corded Readers Only) 36
Precautions **37**

Symbols

The following symbols indicate safety precautions and supplemental information:

 **WARNING:** This symbol indicates a hazard that could cause death, serious personal injury or electrical shock.

 **CAUTION:** This symbol indicates a hazard that could result in property damage.

 **Note:** This symbol indicates additional information about a subject.

 **Tip:** This symbol indicates suggestions and shortcuts that might not otherwise be apparent.

Getting Started

About DataMan 8072 DL



The DataMan 8072 readers offer the industry's most advanced technology for reading 1D and 2D codes regardless of size, quality, printing method or surface, and belong to the only industrial handheld ID reader family that offers Industrial Ethernet communication. DataMan 8072 is available with patented 1DMax+ with Hotbars, class-leading 2-D algorithms and future-proof modular communication slide-ins.

The DataMan 8072 readers are available with the following communication options:

- Ethernet
- USB
- RS-232
- Bluetooth

An intelligent base station is also provided when the DataMan 8072 reader uses the wireless (Bluetooth) communication module. The base station acts as a router between the reader and your computer or network.



Note: Henceforward, the term 'wireless' refers in this document to the Bluetooth communication module of the reader.

The DataMan 8000 series base stations are available with the following communication options:

	Base Station Communication			Wireless Protocol
	Ethernet with Industrial Protocols	USB	RS-232	Bluetooth
DMA-IBASE-BT-02	√	√	√	√





DataMan 8072 DL Accessories

DataMan 8072 Reader Other

Serial/USB slide-in	DMCM-SERIALM-00	
Ethernet slide-in	DMCM-ENETM-00	
Bluetooth slide-in	DMCM-BTM-00	
Charging Base Station	DMA-CBASE-01	
Intelligent Bluetooth Base Station	DMA-IBASE-BT-02	
Power Supply for base station	DMA-24VPWR-xx*	
Power Supply for reader	DM100-PWR-000	
Battery for the wireless reader	DMA-HHBATTERY-01	
Multi-Battery Charger	DMA-MBC-xx*	
POE Adapter	CPS-24V-POE1	
POE Adapter	CPS-24V-POE4	
POE Adapter	CPS-AC-POE1A-xx*	
Wall Mount	DMA-WALL-8000-00	
Wall Mount for Base Station	DMA-IBASE-WALL-00	
Stand	DM-STAND-00	

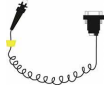

*XX can be US, EN, UK, or JP

DataMan 8072 DL Reader Cables

RS-232 coiled cable for reader, 2.5 m	DM8000-RS232-02	
RS-232 industrial cable for reader, 2.5 m	DM8000-RS232IND-02	
RS-232 coiled cable for reader, 4 m	DM8000-RS232-05	
USB cable, 2.5 m	DM8500-USB-00	
USB coiled cable, 2.5 m	DM8500-USBC-02	
Ethernet Coiled cable, 5m	DM8000-ECABLEC-05*	
Ethernet cable, 2.5 m	DM8000-ECABLE-02	
Ethernet cable, 5 m	DM8000-ECABLE-05	
Ethernet cable, 30 m	DM8000-ECABLE-30	

*Collimated cable length including DM8000-ECABLE-X should not exceed 50 m.

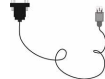
DataMan 8000 Series Base Station Cables

RJ25 (RJ12) to DSUB9 cable for base station, 5 m	DMA-RS232RJ-05	
Straight 10ft USB cable	DMA-USB-00	

- USB cable for base station: Use any standard USB-A to USB-B 2.0 cable up to 3 meters.
- Ethernet cable for base station: Use any standard CAT5/5e, SF/FTP or S/FTP cable.

Physical Layout of the Reader



Physical Layout of the Base Station

DMA-IBASE-BT-02

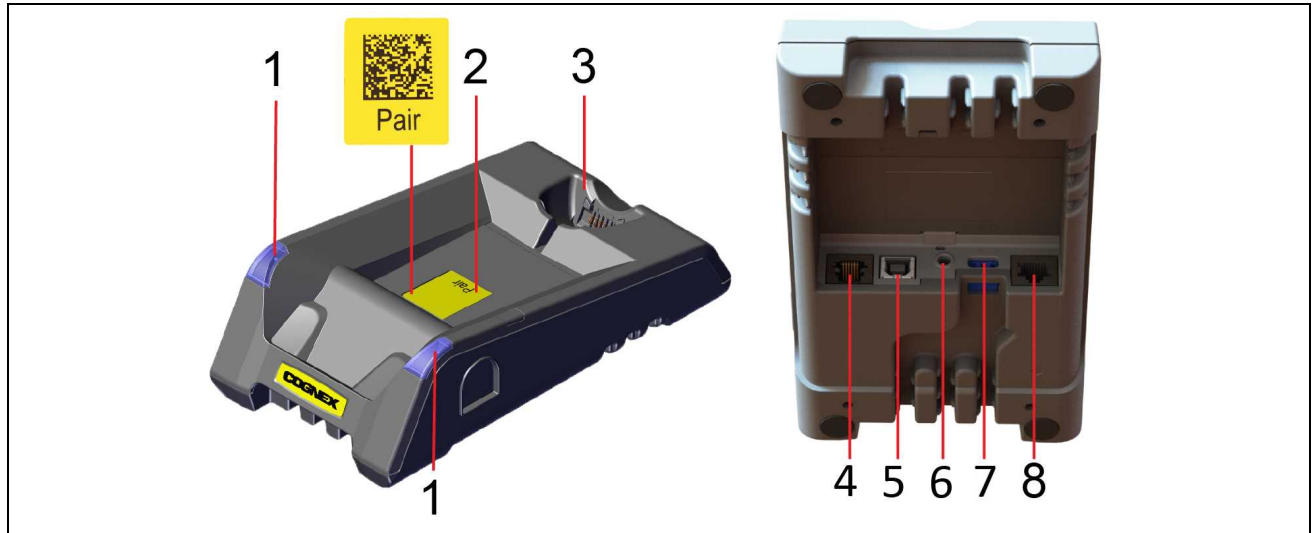

1	Base station status indicators
2	PAIR sticker - Reading the code pairs the base station with the device
3	Connection point to the reader: <ul style="list-style-type: none"> • pairing reader and base station • non-wireless communication • charging
4	RS-232
5	USB
6	Power plug (24V, max. 15W)
7	Alternative power supply connector (24V, max. 15W, polarity marked on the plastic part near the connector). Recommended wire diameter is 14- 18 AWG
8	Ethernet

Base station status indicators:

- Power: RED = base powered / BLINK = wrong reader in base
- Communication: BLUE = Wireless link / BLINK = Wireless communication
- Cradle connections: GREEN = reader properly inserted / BLINK = cradle USB interface communication



Note:

- DMA-IBASE-BT-02 supports Ethernet

Setting Up Your DataMan 8072 DL

Setting Up the Reader

To be able to connect to your reader on your computer, you must perform the following steps:

1. [Install the DataMan Setup Tool](#) on your computer.

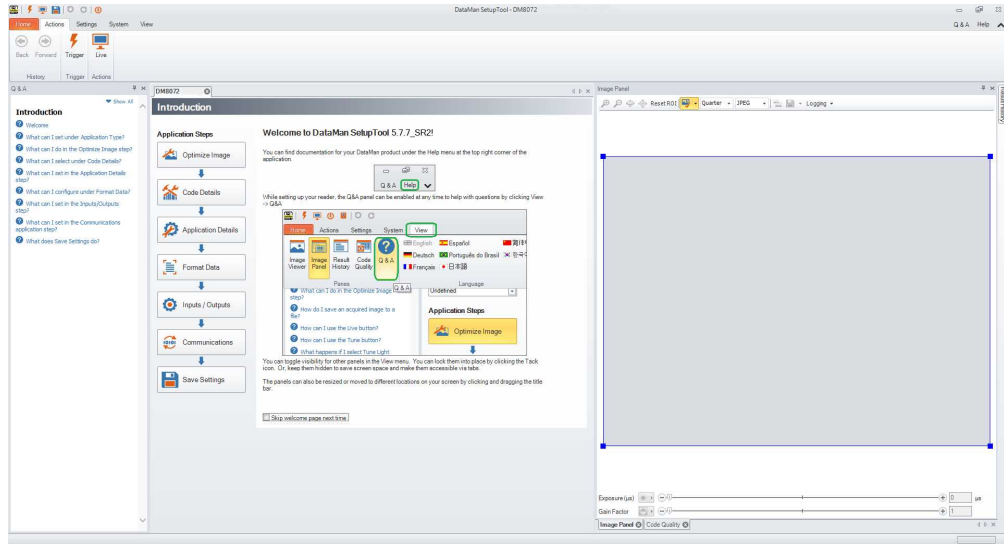

2. Select the connection type: Ethernet or USB; and connect the appropriate cabling.



RS-232

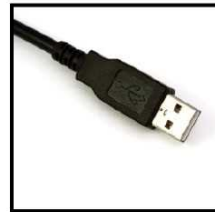

USB

3. Power on your device(s).

Install the DataMan SetupTool

1. Check the DataMan **Release Notes** for a full list of system requirements.
2. Download the DataMan Setup Tool from <http://www.cognex.com/support/dataman> and follow the on-screen steps.
3. Connect the DataMan 8072 to your PC.
4. Launch the DataMan Setup Tool and click **Refresh**. The reader or the base station appears under **COM ports** or **Network devices**.

5. Select a **COM port** or a **Network device** and click **Connect**.



DataMan 8072 DL Specifications

Weight	254 g (without slide-in)
Operating Temperature	0°C — 40°C (32°F — 104°F)
Storage Temperature	-10°C — 60°C (14°F — 140°F)
Maximum Humidity	< 95% (non-condensing)
Environmental	IP65
Codes	1-D barcodes: Codabar, Code 39, Code 128, and Code 93, Interleaved 2 of 5, Pharma, GS1 DataBar, Postal, UPC/EAN/JAN, DataBar 2-D barcodes: Data Matrix™, QR Code and microQR Code, RSS/CS, PDF 417, MicroPDF 417, MaxiCode, Aztec Code
Power Supply Requirements	USB: external 5.0 W maximum LPS or NEC class 2 power supply: +5V - +6V DC RS232 external 5.0W max LPS or NEC class 2 power supply
Inrush current peak	5A maximum Duration: approx. 30µs Electrical charge: 60µAs at 6V
Battery life for wireless reader (typical use case)	ca. 4100 triggers can be operated within a 13 hour working shift
Ethernet	10/100 Base-T FULL/HALF DUPLEX, IEEE 802.3
Bluetooth	Bluetooth™ 2.1, 2.4 GHz

DataMan 8072 DL Imager Specifications

Specification	DataMan 8072 DL Imager
Image Sensor	1/3 inch CMOS
Image Sensor Properties	3.75 µm square pixels
Image Resolution (Pixels)	1280 x 960
Lens Type	6.2 mm F:10 lens

DataMan Base Station Specifications

	DMA-IBASE-BT-02
Weight	300 g

	DMA-IBASE-BT-02
Operating Temperature	0°C — 45°C (32°F — 113°F)
Storage Temperature	-40°C — 60°C (-40°F — 140°F)
Maximum Humidity	95% (non-condensing)
Power Supply Requirements	24V +-10%, 15 W maximum LPS or NEC class 2 power supply Recommended wire diameter is 14-18 AWG

LED Wavelengths

The following table shows LED types and the related wavelengths:

LED	λ [nm]
RED	660

Connection Options

Connecting a DataMan 8072 Through Ethernet

1. Connect the Ethernet slide-in (DMCM-ENETM-00) to your DataMan 8072.



2. With a 2.5 mm Allen wrench, tighten the screws so that the slide-in is firmly locked.

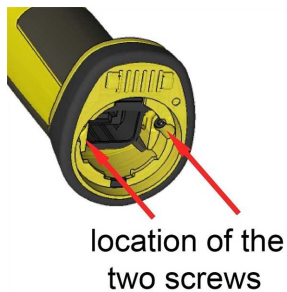

3. Insert the plug and slide the cable lock up to the reader, and twist the cable lock in place.



Use the DM8000-ECABLE-05 (5 meters) or the DM8000-ECABLE-30 (30 meters). You also need a Power Over Ethernet Adapter (CPS-AC-POE1A-xx).

Note: Disconnect the DataMan 8072 reader from power before inserting/removing communication modules.

Troubleshooting an Ethernet Connection

If your reader does not appear in the DataMan Setup Tool's list of detected network devices, you may need to adjust your network settings.

1. First, check your Ethernet connection and click **Refresh** in the DataMan Setup Tool.
2. Next, scan the **Enable DHCP** code below (which you can also find in the *DataMan Reader Configuration Codes* document available from the Windows **Start** menu or the Setup Tool **Help** menu). This might allow the reader to acquire a suitable IP address from a DHCP server on your subnet.

If the reader still does not appear, you can use either the Add Device or Force Network Settings options in the DataMan Setup Tool.

1. If you know the IP address of the reader, use the **Add Network Device** option under **Reader Maintenance**.
2. If you do not know the IP address, use the **Force Network Settings** option. Either method should allow the DataMan 8072 reader to appear in the list of **Network devices** so that you can connect to it through the DataMan Setup Tool and your Ethernet connection.

If none of the above helps, reset your reader to factory defaults by scanning the **Reset Scanner to Factory Defaults** code below.



Enable DHCP



Reset Scanner to
Factory Defaults

Connecting a DataMan 8072 DL Through RS-232

1. Connect the serial slide-in (DMCM-SERIALM-00) to your DataMan 8072.



2. With a 2.5 mm Allen wrench, tighten the screws so that the slide-in is firmly locked.

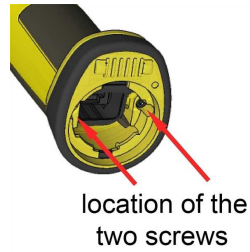

3. Insert the plug and slide the cable lock up to the reader and twist the cable lock in place.



Use the DM8000-RS232-02 cable (2.5 meters) or the DM8000-RS232-05 cable (5 meters). For power supply, use the DataMan 8000 Power Supply (DM100-PWR-000).

Note: Disconnect the DataMan 8072 reader from power before inserting/removing the communication modules.

Observe the following electrical requirements:

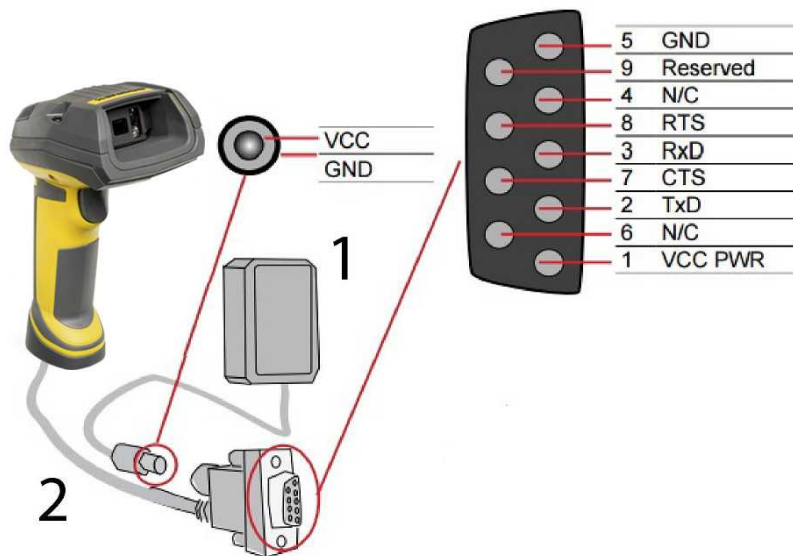

1	6VDC power supply (DM100-PWR-000), a 5.5 mm x 2.1 mm DC Power Plug
2	VCC = +4.75V up to +6.0V for 2.5 m cable VCC = +5.5V up to +6.0V for 5.0 m cable

WARNING: For proper RS-232 operation, do not apply any voltage to pin 9.

Note: Power on the RS-232 cable can be supplied by either the DC Power Plug or Pin 1 of the D-SUB. **DO NOT** use both in parallel.

Connecting a DataMan 8072 through USB

1. Connect the serial slide-in (DMCM-SERIALM-00) to your DataMan 8072.



2. With a 2.5 mm Allen wrench, tighten the screws so that the slide-in is firmly locked.

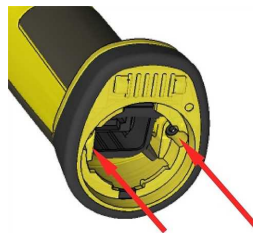

location of the
two screws

3. Insert the plug, slide the cable lock up to the reader and twist the cable lock in place.



Use the DM8500-USB-00 cable (2.5 meters) or the DM8500-USBC-02 cable (2.5 meters).

Note: Disconnect the DataMan 8072 reader from power before inserting/removing the communication modules.

Using Your Device Through USB

If you connect your reader with the coiled USB cable, you must use your device in USB 1.1 mode. With a straight USB cable, you can use your device in both modes.

Change the **USB Connection** in the **Serial** tab of the **Communication Settings** pane in DataMan Setup Tool, or scan the appropriate code from the *DataMan Configuration Codes* document.



You can also switch the USB mode (CDC or HID) of both the reader and the base station with a pair of RP codes. Perform the following steps:

In the case of a corded reader:



1. Disconnect from the DataMan Setup Tool if you are connected.
2. Scan the “**USB Keyboard**” code from the *DataMan Configuration Codes* document.
3. Start scanning codes with your corded reader.

In the case of a wireless reader:



Bluetooth

1. Disconnect from the DataMan Setup Tool if you are connected.
2. Scan the “**Enable USB Keyboard for the base station**” code from the *DataMan Configuration Codes* document.
3. Start scanning codes with your wireless reader.

Using DataMan 8072 Wireless Reader

Connecting to a Wireless DataMan 8072 Through a Base Station

1. Connect the wireless slide-in (DMCM-BTM-00) to your DataMan 8072.

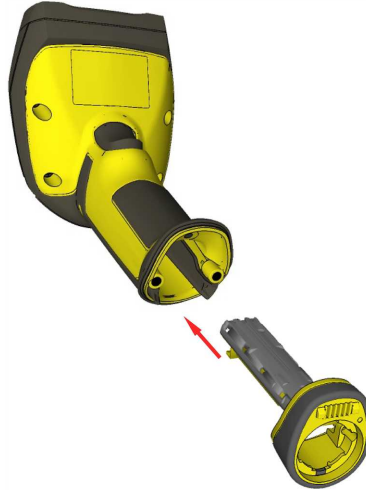

2. With a 2.5 mm Allen wrench, tighten the screws so that the slide-in is firmly locked.

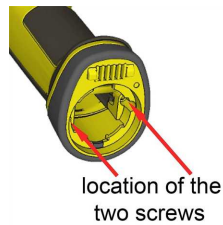

3. Insert the battery.

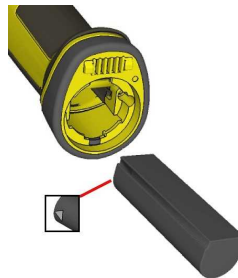

Note: Remove the battery from your DataMan 8072 before inserting/removing the communication module.

4. Insert the plug and twist it in place.



5. Power up the DMA-IBASE-BT-XX base station using a 24V power supply (DMA-24VPWR-XX).

6. Connect your base station to your PC using either serial, USB or Ethernet communication.

DMA-IBASE-BT-02

1	RS-232 connection
2	USB connection
3	Power
4	Alternative power supply connector
5	Ethernet connection

Observe the following electrical requirements when connecting the base station through RS-232:

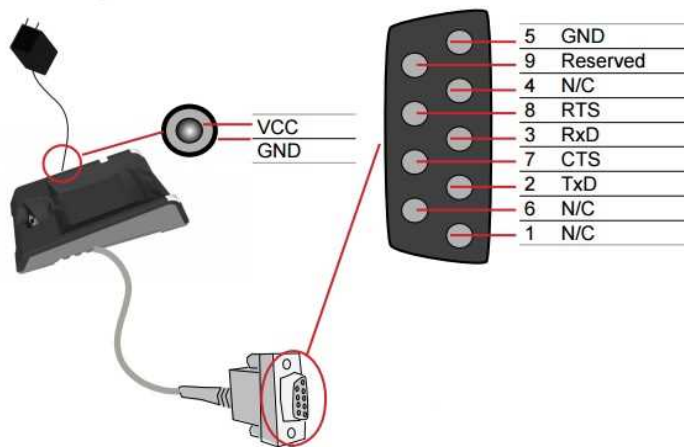

⚠ WARNING: For proper RS-232 operation, do not apply any voltage to pin 9.

Power to the base station can be supplied by either the DC power plug or by wiring in 24V. **DO NOT** use both in parallel. The DC power plug is a 24VDC power supply (DMA-24VPWR-xx), 3.5 mm x 1.3 mm.

Note: Be careful to use the appropriate connector for RS-232. See [Step 6](#) above.

7. When the base station is powered up, scan the Pair scan code and place your reader into the base station. The base station's status indicator becomes green. When the wireless reader is removed from the base, a wireless connection is established. The status indicator of both the base station and the reader become blue and you can hear a beep. Blue lights indicate that the reader and the base have successfully paired and are communicating.
8. Connect to your base station or to the wireless reader. You have the following connection options:

Base Station Connection Type	Connect to Reader in the DataMan Setup Tool	Connection Channels
RS-232	Wireless reader appears: COM port (Base Station does not appear)	terminal program Setup Tool
USB	Base Station appears: COM port 1 Wireless reader appears: COM port 2	terminal program Setup Tool
Ethernet	Base station appears: Network device 1 Wireless reader appears: Network device 2	terminal program Setup Tool

9. Lift your reader up from the base station and start reading codes.

Note:

- When the reader is on the base station, communication is established by means of cradle contacts. Wireless communication is disabled.
- Configure wireless communication settings by connecting to the base station. In order for the changed settings to be synchronized between the DataMan 8072 wireless reader and the base station, place your reader in the base station after your changes are saved. To assign a static IP address to the base station or the reader when communicating via Ethernet, connect to the base station in the DataMan Setup Tool. The base station, however, auto-assigns the IP address to the reader when they become paired.
- When you connect with the base station to a terminal program, your wireless reader sends decode results to the terminal, but you cannot send commands to the reader.
- If you want to unpair your reader from the base station, you can either click Unassign in the Bluetooth or Wireless tab of the *Communication Settings* pane of the DataMan Setup Tool (when you are connected either with the reader or the base station), or scan the "Unassign Reader" reader configuration code.
- If you place the wrong reader (that is, a reader that is not associated with the base station) into the base station, the base station status indicator flashes red and a series of short beeps can be heard.

Pairing Strategy (DMA-IBASE-BT-02)

In order to pair the base station and the reader in a single step without considering former pairing states and without using the DataMan Setup Tool, scan the Pair sticker from the scan code sticker on the base station. Place the reader in the base station.

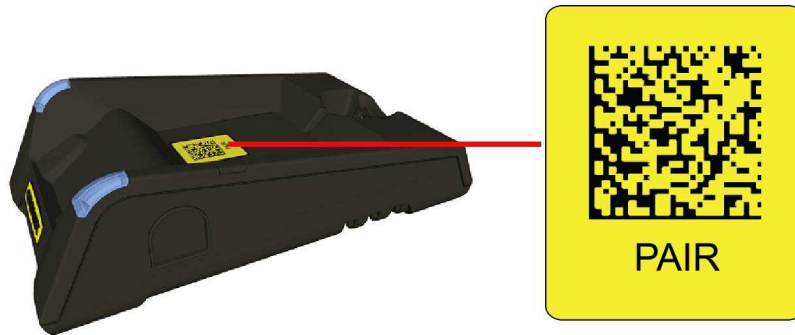

The reader then blinks green/blue until it gets paired with the base station (or until the end of the 20 second timeout period). When the reader is put on the base station, the base station drops its pairing with its old reader and pairs with the new reader.



Note: Scanning the Pair code puts the base station and the reader put on it into **force pairing mode**. This means **i** that the reader and the base it is put on get paired regardless of any assignments they both had previously. This force pairing mode is valid for 20 seconds after reading the Pair code.

The base station's indicators turn green to indicate successful pairing:



When the reader is put onto another (unpaired) base station without any previous actions, the base station signals this event with beeping and red flashing of its indicators:



The base station that is paired with a certain reader signals a bad reader alert (beeps and flashing red indicators) also when another, unassigned reader is put into it.

Base Station Routing Capabilities

The base station is visible as connected through either RS-232, USB or Ethernet, but it routes data through the wireless interface to the reader.

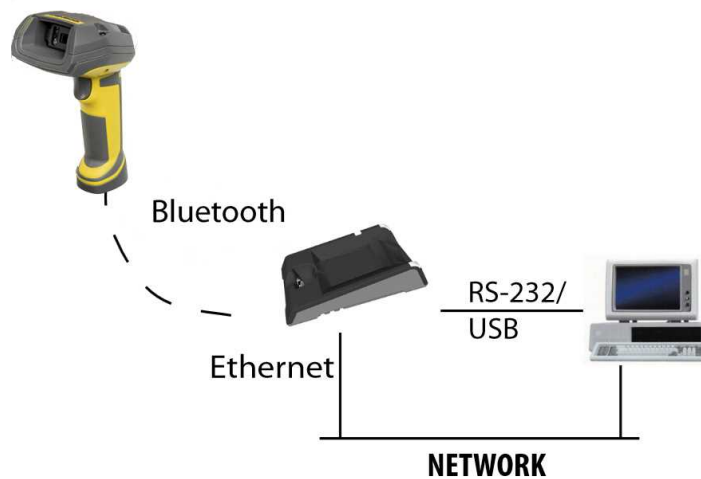

Wireless Reader: Buffering Data

When you are within the wireless range of the base station, your wireless reader sends decoded data to your PC through the base station, just as if you used a tethered reader. You can also see the decoded images in the DataMan Setup Tool, if it is running and is connected to the reader.

When you leave the wireless range, however, you lose connection to your PC, but you can still keep reading codes. The decoded data is saved in the buffer of the reader.

This buffered data appears on your PC again when you come back within the wireless range, but **ONLY IF** you were connected to a terminal program when you left the wireless range.

Buffered read results on the reader are not displayed in the DataMan Setup Tool; they are only transmitted over an existing keyboard emulation, RS-232 Serial or TCP/IP Telnet connection.

Note: The images acquired by the reader when it is out of the wireless range are never saved, and cannot be retrieved.

Open a connection with the reader in a terminal program so that you gain the buffered data when wireless connection is established again.

See the following table for connection options according to communication type:

Base Station Connection Type	How to Connect
RS-232	Connect to the COM port of the base station.
USB	Connect to the COM port of the wireless reader.
Ethernet	Connect to the terminal program using the IP address of the reader. To find out the IP address, go to the Connect backstage page in the DataMan Setup Tool and check the IP address of the reader in the Address column.
USB Keyboard	Open the text editor or your program of choice to use keyboard emulation. When you return to the wireless range, keyboard emulation continues, starting with the buffered data.

While you are still within the wireless range, the reader occasionally blinks blue to indicate that the wireless connection is established.

When the reader leaves the wireless range, the base station's signal becomes red.



Blinking blue status indicator: wireless connection is alive.



When you leave the wireless range, you can still keep reading codes. The reader going offline is indicated by a long beep and the status indicator flashes magenta. The status indicator blinks magenta: your reader is offline.



When the reader is offline, good reads are indicated with 2 short beeps and the selected good read status indicator color (green by default). The status indicator beeps twice: your reader is offline while decoding symbols.



When the buffer is full, no more codes are read. The reader does not discard the oldest read.

When the buffer is full, the reader beeps and the status indicator becomes white.



Summary of Wireless Buffering Indicators

Condition	Status Indicator: Reader	Status Indicator: Base Station	Sounds
Reader in wireless range of base station	When the reader is awake, blinking blue indicates wireless connection with the base. When the reader is offline, no indicator. Pull the trigger to wake it up and it will blink blue. Good read: green , single beep (default) No read: red , no beep (default)	Reader out of the base station and reader is awake: steady blue . Reader out of the base station and reader is offline: steady red . Paired reader in the base station: flashing green . Base station is receiving data or images from reader: steady blue .	Good read: 1 beep (default) No read: no beep (default)
Reader out of wireless range of base station	Offline: When the reader wakes up out of the wireless range, there is no indicator. Good read: green (default) No read: red (default)	Reader offline: steady red .	Long beep when you leave the wireless range. Good read: 2 beeps No read: no beep
Reader out of wireless range, buffer is full	Good read: green and then white. No read: red (default)	Reader offline: steady red .	Good read: long beep No read: no beep

Wireless Reader: Charging

When you are reading codes with your wireless reader, blinking red status indicators will indicate a low battery. As the battery discharges, the blink frequency increases. A blinking red status indicator indicates low battery or thermal shutdown mode.



You can also check the status of the battery in the DataMan Setup Tool.

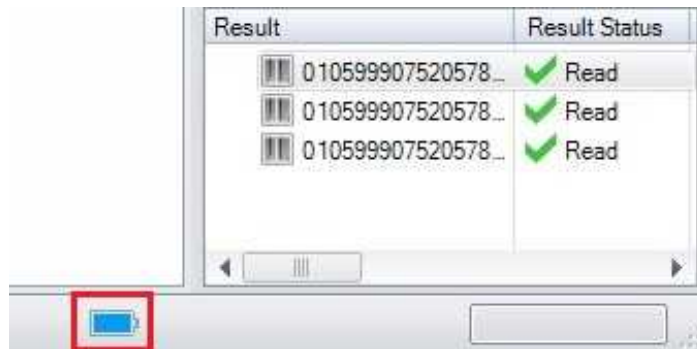

Place the reader on the base station for charging. Make sure that the pins at the end of the handle make contact with the pins in the base station.

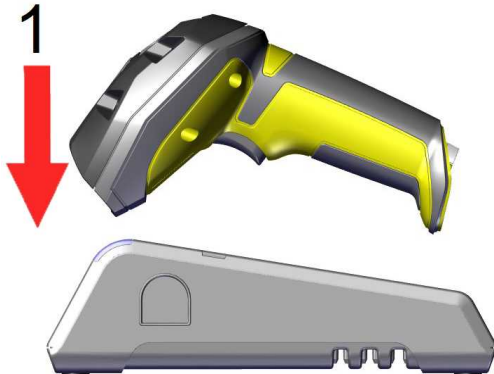

Paired Reader Charging

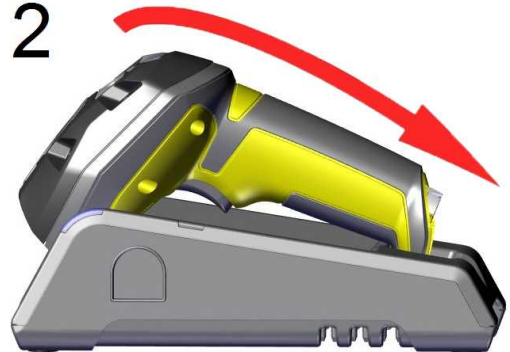

Paired Reader Fully Charged

Refer to the following table for a summary of indicators regarding charging:

Condition	Status Indicator: Reader	Status Indicator: Base Station
Battery low	flashing red indicators	steady blue, indicating connection flashing blue, indicating data transfer
Reader is charging in the base station	steady red indicators	steady green, indicating connection flashing green, indicating data transfer
Reader is fully charged in the base station	steady green indicators	steady green, indicating connection flashing green, indicating data transfer

Wireless Reader: Changing Batteries

To change batteries, perform the following steps:

1. Twist the reader's end cap, and take it off.

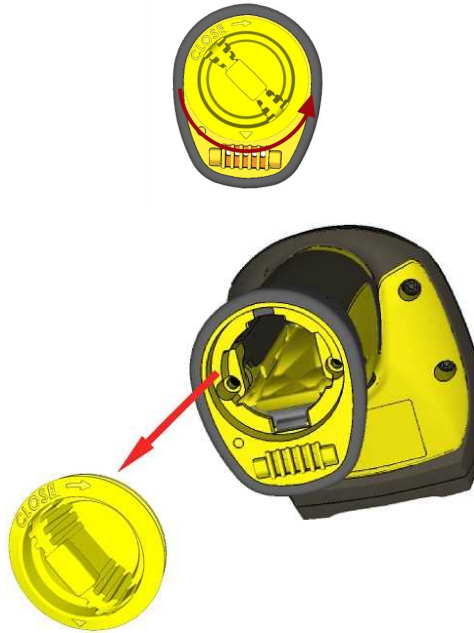

2. Hold the reader in an upright position and the battery will slide out of the handle.

Note: You may need to shake the reader slightly.

CAUTION: The battery used in these devices may present a risk of fire or chemical burn if mistreated. Do not disassemble, heat above 60°C (140°F), or incinerate. Replace battery with Cognex DMA-HHBATTERY-01 only. The use of another battery may present a risk of fire or explosion.

3. Put the replacement battery into the slot. The battery has a small triangle on one side. Make sure that you insert the battery in a way that the triangle end goes into the slot first.

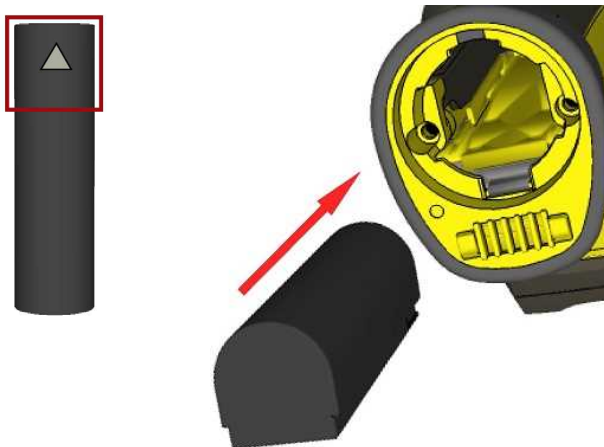

- Put the end cap back on and twist it. Make sure that the triangle aligns with the circle when the cover is locked.

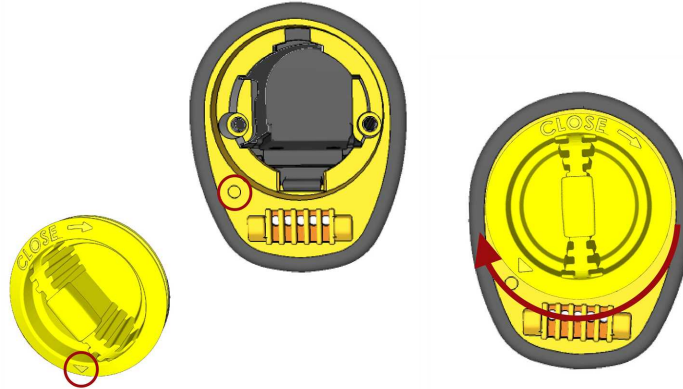

- If using DMA-CBASE-01, place the battery in the spare battery charger in the direction of the small triangle of the battery.



When you are charging the auxiliary battery, the base station's spare battery status indicator displays either charging in progress (red) or fully charged (green).



- Dispose of used battery promptly. Keep it away from children. Do not disassemble and do not burn it. Use the appropriate separate take-back systems for battery disposal.

Reading Codes with the DataMan 8072 DL

Industrial Protocols

The DataMan 8072 readers support the following industrial protocols:

- EtherNet/IP™
- PROFINET
- SLMP Protocol
- Modbus TCP

Select the industrial protocol tools and sample programs when installing the DataMan Setup Tool.

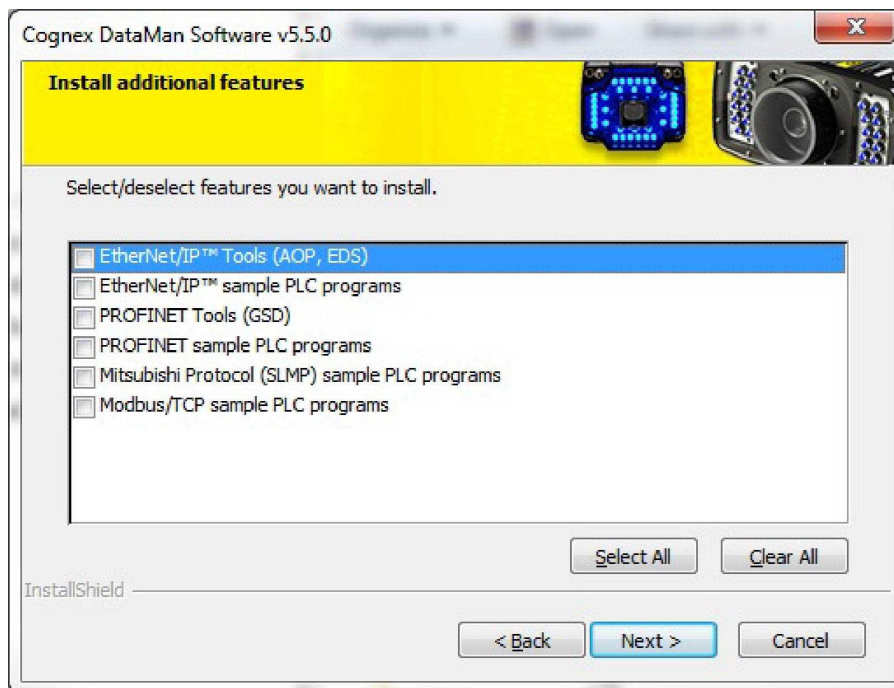

There are three ways to enable or disable Industrial Protocols. Using either method, a reboot is required for the changes to come into effect.

- Enable the protocols using the **Industrial Protocols** pane of the DataMan Setup Tool (under **Communication Settings**).
- Scan the appropriate **Reader Configuration codes** (see **Reader Configuration Codes** available through the Windows **Start** menu or the Setup Tool **Help** menu).
- Send the appropriate **DMCC** (see **Command Reference** available through the Windows **Start** menu or the Setup Tool **Help** menu).

For more information on using the industrial protocols, see the **DataMan Industrial Protocols Manual** available through the Windows **Start** menu or the Setup Tool **Help** menu.

Trigger Types

The DataMan 8072 trigger mode determines when the reader attempts to read a code. Use the DataMan Setup Tool or the appropriate reader configuration codes to change trigger types.

The following trigger types are supported:

- Presentation: The LED aimer is always on. When motion is detected in front of the reader, the reader will turn on and scan for a symbol. The reader relies on an internal timing mechanism to acquire images.
- Manual (default): The reader begins acquiring images when you press the trigger button on the reader, and continues acquiring images until a symbol is found and decoded or you release the button.

Note that while in Presentation mode, as the operator pulls the trigger, the reader switches to Manual mode until the device is re-docked into the base station. Setup Tool continues to display Presentation mode while in this state. To bring it back to standard Presentation mode, use one of the following options:

- Dock the device into the base station
- Switch to Manual trigger mode in Setup Tool, then switch back to Presentation mode
- Scan the Enter Presentation Reader Configuration Code

Field of View and Reading Distances

The following map shows the range of reading distances available for different code sizes and focus positions.

DataMan 8072 DL field of view and reading distances:

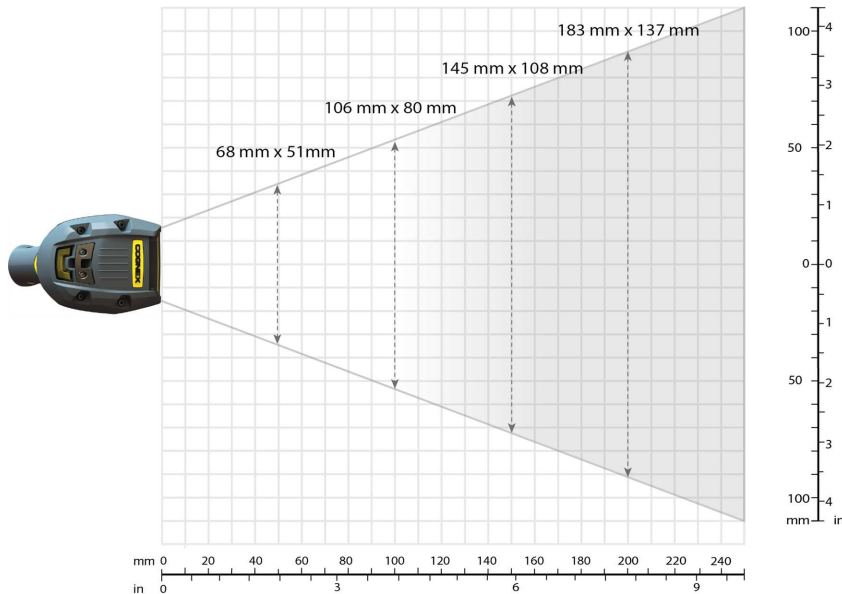

Device	Distances in mm/ 1D min. code		Distances in mm/ 2D min. code	
	DM8072	20-170	6 MIL	0-200
0-200		10 MIL	0-260	15 MIL
0-260		15 MIL	0-300	20 MIL

Cleaning and Maintenance

Cleaning the Reader Housing

To clean the outside of the reader housing, use a small amount of mild detergent cleaner or isopropyl alcohol on a cleaning cloth. Do not pour the cleaner directly onto the reader housing.

 **CAUTION:** Do not attempt to clean any DataMan product with harsh or corrosive solvents, including lye, methyl ethyl ketone (MEK) or gasoline.

Cleaning the Reader Lens Cover

To remove dust from the lens cover, use a pressurized air duster. The air must be free of oil, moisture or other contaminants that could remain on the lens cover. To clean the plastic window of the lens cover, use a small amount of isopropyl alcohol on a cleaning cloth. Do not scratch the plastic window. Do not pour the alcohol directly on the plastic window.

Compliance Information, Warnings and Notices

Regulations/Conformity

The DataMan 8072 has Regulatory Model R00049, and meets or exceeds the requirements of all applicable standards organizations for safe operation. However, as with any electrical equipment, the best way to ensure safe operation is to operate them according to the agency guidelines that follow. Please read these guidelines carefully before using your device.

Note: For the most current CE declaration and regulatory conformity information, see the Cognex support site: cognex.com/support.

Regulator	Specification
USA	FCC Part 15B, Class A
Canada	ICES-003, Class A
European Community	CE, Class A EN55032 EN55024
Japan	VCCI-3/2015.04 CISPR 22 Class A
Korea	KN32/KN35

Safety and Regulatory	
Manufacturer	Cognex Corporation One Vision Drive Natick, MA 01760 USA
CE	This is a class A product. In a domestic environment this product may cause radio interference in which case the user may be required to take immediate measures. This equipment complies with the essential requirements of the EU Directive 2014/30/EU. Declarations are available from your local representative.
FCC	FCC Part 15, Class A This equipment has been tested and found to comply with the limits for a Class A digital device, pursuant to part 15 of the FCC Rules. These limits are designed to provide reasonable protection against harmful interference when the equipment is operated in a commercial environment. This equipment generates, uses, and can radiate radio frequency energy and, if not installed and used in accordance with the instruction manual, may cause harmful interference to radio communications. Operation of this equipment in a residential area is likely to cause harmful interference in which case the user will be required to correct the interference at his own expense.
Canadian Compliance	This Class A digital apparatus complies with Canadian ICES-003. Cet appareil numérique de la classe A est conforme à la norme NMB-003 du Canada.

LED Safety Statement

For European Community Users

Cognex complies with Directive 2012/19/EU OF THE EUROPEAN PARLIAMENT AND OF THE COUNCIL of 4 July 2012 on waste electrical and electronic equipment (WEEE).

This product has required the extraction and use of natural resources for its production. It may contain hazardous substances that could impact health and the environment, if not properly disposed.

In order to avoid the dissemination of those substances in our environment and to diminish the pressure on the natural resources, we encourage you to use the appropriate take-back systems for product disposal. Those systems will reuse or recycle most of the materials of the product you are disposing in a sound way.



The crossed out wheeled bin symbol informs you that the product should not be disposed of along with municipal waste and invites you to use the appropriate separate take-back systems for product disposal.

If you need more information on the collection, reuse, and recycling systems, please contact your local or regional waste administration.



You may also contact your supplier for more information on the environmental performance of this product.

Compliance Statements: DataMan Base Station

The DataMan Base Stations have the following Regulatory models respectively: DMA-IBASE-BT-XX has 1AAG, DMA-CBASE-01 has R00046, and they meet or exceed the requirements of all applicable standards organizations for safe operation. However, as with any electrical equipment, the best way to ensure safe operation is to operate them according to the agency guidelines that follow.

Note: For the most current CE declaration and regulatory conformity information, see the Cognex support site: cognex.com/support.

Please read these guidelines carefully before using your device.

Safety and Regulatory	
Manufacturer	Cognex Corporation One Vision Drive Natick, MA 01760 USA
European Compliance 	This is a class A product. In a domestic environment this product may cause radio interference in which case the user may be required to take immediate measures. This equipment complies with the essential requirements of the EU Directive 2014/30/EU. Declarations are available from your local representative. DMA-IBASE-BT-XX: This equipment complies with the essential requirements of EU Directives 2014/30/EU and 2014/53/EU as applicable. Declarations are available from your local representative. DMA-IBASE-01 and DMA-CBASE-01: This equipment complies with the essential requirements of EU Directives 2014/30/EU and 2014/53/EU as applicable. Declarations are available from your local representative.
FCC Class A Compliance Statement 	This equipment has been tested and found to comply with the limits for a Class A digital device, pursuant to part 15 of the FCC Rules. These limits are designed to provide reasonable protection against harmful interference when the equipment is operated in a commercial environment. This equipment generates, uses, and can radiate radio frequency energy and, if not installed and used in accordance with the instruction manual, may cause harmful interference to radio communications. Operation of this equipment in a residential area is likely to cause harmful interference in which case the user will be required to correct the interference at his own expense. This device complies with Part 15 of the FCC Rules and with RSS-210 of Industry Canada. Operation is subject to the following two conditions: (1) this device may not cause harmful interference, and (2) this device must accept any interference received, including interference that may cause undesired operation. Changes or modifications made to this equipment not expressly approved by Cognex may void the FCC authorization to operate this equipment.
Canadian Compliance	This Class A digital apparatus complies with Canadian ICES-003. Cet appareil numérique de la classe A est conforme à la norme NMB-003 du Canada.
UL and cUL Statement 	UL and cUL listed: UL60950-1 2nd ed. and CSA C22.2 No.60950-1 2nd ed.
Mexican Compliance	DMA-IBASE-BT-XX: RCPCO1A15-0073 DMA-IBASE-01: RCPCODM12-0655
Chinese Compliance	DMA-IBASE-BT-XX: CMIIT ID: 2015DJ0237 DMA-IBASE-01: CMIIT ID: 2012DJ2857

For European Community Users

Cognex complies with Directive 2012/19/EU OF THE EUROPEAN PARLIAMENT AND OF THE COUNCIL of 4 July 2012 on waste electrical and electronic equipment (WEEE).

This product has required the extraction and use of natural resources for its production. It may contain hazardous substances that could impact health and the environment, if not properly disposed.

In order to avoid the dissemination of those substances in our environment and to diminish the pressure on the natural resources, we encourage you to use the appropriate take-back systems for product disposal. Those systems will reuse or recycle most of the materials of the product you are disposing in a sound way.



The crossed out wheeled bin symbol informs you that the product should not be disposed of along with municipal waste and invites you to use the appropriate separate take-back systems for product disposal.

If you need more information on the collection, reuse, and recycling systems, please contact your local or regional waste administration.

You may also contact your supplier for more information on the environmental performance of this product.

中国大陆RoHS (Information for China RoHS Compliance)

根据中国大陆《电子信息产品污染控制管理办法》(也称为中国大陆RoHS), 以下部份列出了本产品中可能包含的有毒有害物质或元素的名称和含量。



Table of toxic and hazardous substances/elements and their content, as required by China's management methods for controlling pollution by electronic information products.

Part Name 部件名称	Hazardous Substances 有害物质					
	Lead (Pb) 铅	Mercury (Hg) 汞	Cadmium (Cd) 镉	Hexavalent Chromium (Cr (VI)) 六价铬	Polybrominated biphenyls (PBB) 多溴联苯	Polybrominated diphenyl ethers (PBDE) 多溴二苯醚
Regulatory Model R00049 Regulatory Model 1AAJ Regulatory Model 1AAG Regulatory Model R00046	X	O	O	O	O	O

This table is prepared in accordance with the provisions of SJ/T 11364.
这个标签是根据SJ / T 11364 的规定准备的。

O: Indicates that said hazardous substance contained in all of the homogeneous materials for this part is below the limit requirement of GB / T26572 - 2011.
表示本部件所有均质材料中含有的有害物质低于GB / T26572 - 2011 的限量要求。

X: Indicates that said hazardous substance contained in at least one of the homogeneous materials used for this part is above the limit requirement of GB / T26572 - 2011.
表示用于本部件的至少一种均质材料中所含的有害物质超过GB / T26572 - 2011 的限制要求。

Reader Control Codes



Reset Scanner to
Factory Defaults



Reboot
Scanner



USB Serial



USB Keyboard



Enable DHCP



USB Keyboard for
Base Station



Pair

Keyboard Language (Corded Readers Only)



US English



German



French



Spanish



Japanese

Precautions

To reduce the risk of injury or equipment damage, observe the following precautions when you install the Cognex product:

- Route cables and wires away from high-current wiring or high-voltage power sources to reduce the risk of damage or malfunction from the following causes: over-voltage, line noise, electrostatic discharge (ESD), power surges, or other irregularities in the power supply.
- Changes or modifications not expressly approved by the party responsible for regulatory compliance could void the user's authority to operate the equipment.
- Ensure that the cable bend radius begins at least six inches from the connector. Cable shielding can be degraded or cables can be damaged or wear out faster if a service loop or bend radius is tighter than 10X the cable diameter.
- This device should be used in accordance with the instructions in this manual.
- All specifications are for reference purposes only and can change without notice.

