

DataMan[®] Industrial Protocols Manual

2020 April 14

Revision: 6.1.6SR1.7

Legal Notices

The software described in this document is furnished under license, and may be used or copied only in accordance with the terms of such license and with the inclusion of the copyright notice shown on this page. Neither the software, this document, nor any copies thereof may be provided to, or otherwise made available to, anyone other than the licensee. Title to, and ownership of, this software remains with Cognex Corporation or its licensor. Cognex Corporation assumes no responsibility for the use or reliability of its software on equipment that is not supplied by Cognex Corporation. Cognex Corporation makes no warranties, either express or implied, regarding the described software, its merchantability, non-infringement or its fitness for any particular purpose.

The information in this document is subject to change without notice and should not be construed as a commitment by Cognex Corporation. Cognex Corporation is not responsible for any errors that may be present in either this document or the associated software.

Companies, names, and data used in examples herein are fictitious unless otherwise noted. No part of this document may be reproduced or transmitted in any form or by any means, electronic or mechanical, for any purpose, nor transferred to any other media or language without the written permission of Cognex Corporation.

Copyright © 2019. Cognex Corporation. All Rights Reserved.

Portions of the hardware and software provided by Cognex may be covered by one or more U.S. and foreign patents, as well as pending U.S. and foreign patents listed on the Cognex web site at: cognex.com/patents.

The following are registered trademarks of Cognex Corporation:

Cognex, 2DMAX, Advantage, AlignPlus, Assemblyplus, Check it with Checker, Checker, Cognex Vision for Industry, Cognex VSOC, CVL, DataMan, DisplayInspect, DVT, EasyBuilder, Hotbars, IDMax, In-Sight, Laser Killer, MVS-8000, OmniView, PatFind, PatFlex, PatInspect, PatMax, PatQuick, SensorView, SmartView, SmartAdvisor, SmartLearn, UltraLight, Vision Solutions, VisionPro, VisionView

The following are trademarks of Cognex Corporation:

The Cognex logo, 1DMax, 3D-Locate, 3DMax, BGAll, CheckPoint, Cognex VSoC, CVC-1000, FFD, iLearn, In-Sight (design insignia with cross-hairs), In-Sight 2000, InspectEdge, Inspection Designer, MVS, NotchMax, OCRMax, PatMax RedLine, ProofRead, SmartSync, ProfilePlus, SmartDisplay, SmartSystem, SMD4, VisiFlex, Xpand

Portions copyright © Microsoft Corporation. All rights reserved.

Portions copyright © MadCap Software, Inc. All rights reserved.

Other product and company trademarks identified herein are the trademarks of their respective owners.

Table of Contents

Legal Notices	2
Table of Contents	3
Symbols	5
About This Manual	6
Industrial Network Protocols	7
EtherNet/IP	7
DMCC	7
Reader Configuration Code	8
Setup Tool	8
Getting Started	9
Object Model	13
Rockwell ControlLogix Examples	24
Rockwell CompactLogix Examples	37
PROFINET	50
DMCC	50
Reader Configuration Code	50
Setup Tool	51
Getting Started	52
Object Model	55
SIMATIC Examples	62
TIA Portal Examples	74
SLMP Protocol	83
DMCC	83
Reader Configuration Code	83
SLMP Protocol Scanner	84
Getting Started	84
Network Configuration	86
Data Block Configuration	86
Interface	87
Operation	92
Examples	96
ModbusTCP	100
DMCC	100
Reader Configuration Code	100
Setup Tool	101
Modbus TCP Handler	101
Getting Started	101
Network Configuration	102
Data Block Configuration	103
Interface	104
Operation	108
Examples	112
Industrial Protocols for the Wireless DataMan	116
Protocol Operation	116
Ethernet Address	116

PLC Triggering	116
SoftEvents	116
DMCC	116
Offline Buffering	117
Status of Industrial Protocols	117

Symbols

The following symbols indicate safety precautions and supplemental information:

 **WARNING:** This symbol indicates a hazard that could cause death, serious personal injury or electrical shock.

 **CAUTION:** This symbol indicates a hazard that could result in property damage.

 **Note:** This symbol indicates additional information about a subject.

 **Tip:** This symbol indicates suggestions and shortcuts that might not otherwise be apparent.

About This Manual

The DataMan reader connected to a network can be triggered to acquire images by several methods:

- using the DataMan Setup Tool
- trigger bits
- through a DMCC command
- manipulating objects through industrial protocols

The *DataMan Industrial Protocols Manual* provides information on how to integrate DataMan readers into your particular environment using industrial protocols.

Industrial Network Protocols

DataMan uses industrial network protocols that are based on standard Ethernet protocols. These protocols, EtherNet/IP, PROFINET, SLMP Protocol, and Modbus/TCP, are enhanced to provide more reliability than standard Ethernet.

When you install the Setup Tool, the Installer prompts you to download the tools and sample programs associated with industrial protocols.

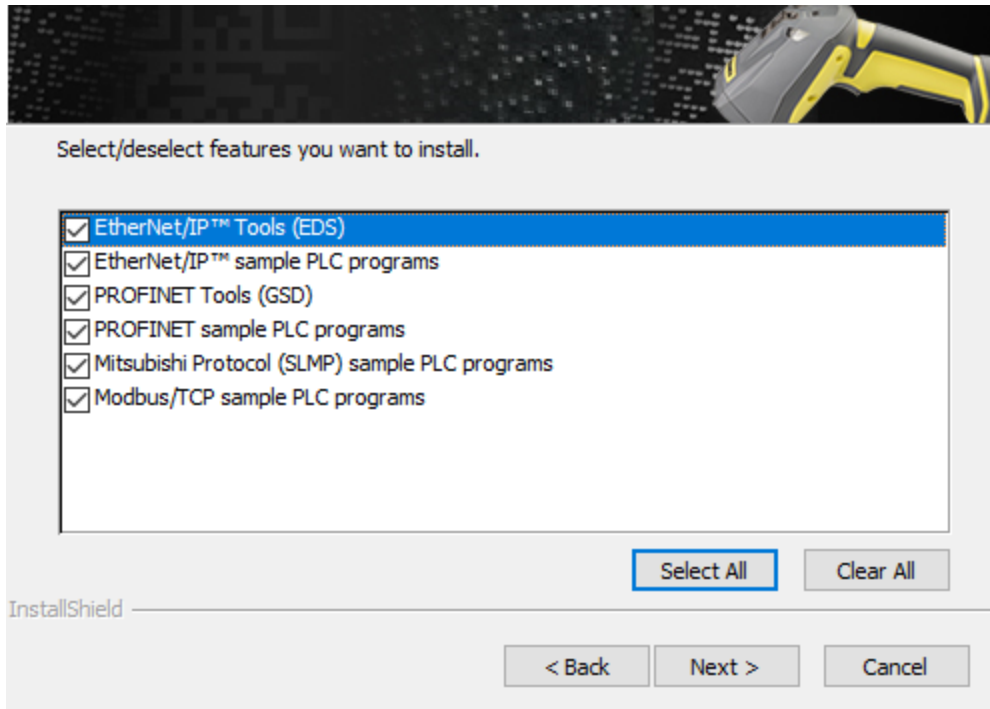

EtherNet/IP

DataMan supports EtherNet/IP™, an application level protocol based on the Common Industrial Protocol (CIP). EtherNet/IP provides an extensive range of messaging options and services transferring data and I/O over Ethernet. All devices on an EtherNet/IP network present their data to the network as a series of data values called attributes. Attributes can be grouped with other related data values into sets called Assemblies.

By default the DataMan device has the EtherNet/IP protocol disabled. The protocol can be enabled via DMCC, scanning a configuration code, or in the DataMan Setup Tool.

Note: If you have a wireless DataMan reader, see section [Industrial Protocols for the Wireless DataMan on page 116](#)

DMCC

The following commands can be used to enable/disable EtherNet/IP on a DataMan reader. The commands can be issued via RS-232 or Telnet connection.

Note: Use a third party Telnet client such as PuTTY to communicate with your DataMan reader.

Enable:

```
||>SET ETHERNET-IP.ENABLED ON  
||>CONFIG.SAVE  
||>REBOOT
```

Disable:

```
||>SET ETHERNET-IP.ENABLED OFF  
||>CONFIG.SAVE  
||>REBOOT
```

Reader Configuration Code

Scan the following reader configuration codes to enable/disable EtherNet/IP on your corded reader.

Note: You must reboot the device for the change to take effect.



Scan the following reader configuration codes to enable/disable EtherNet/IP on your DataMan 8000 base station.

Note: You must reboot the device for the change to take effect.



Setup Tool

In the Setup Tool's **Communications** application step's **Ethernet** tab, check **EtherNet/IP** to enable this industrial protocol.

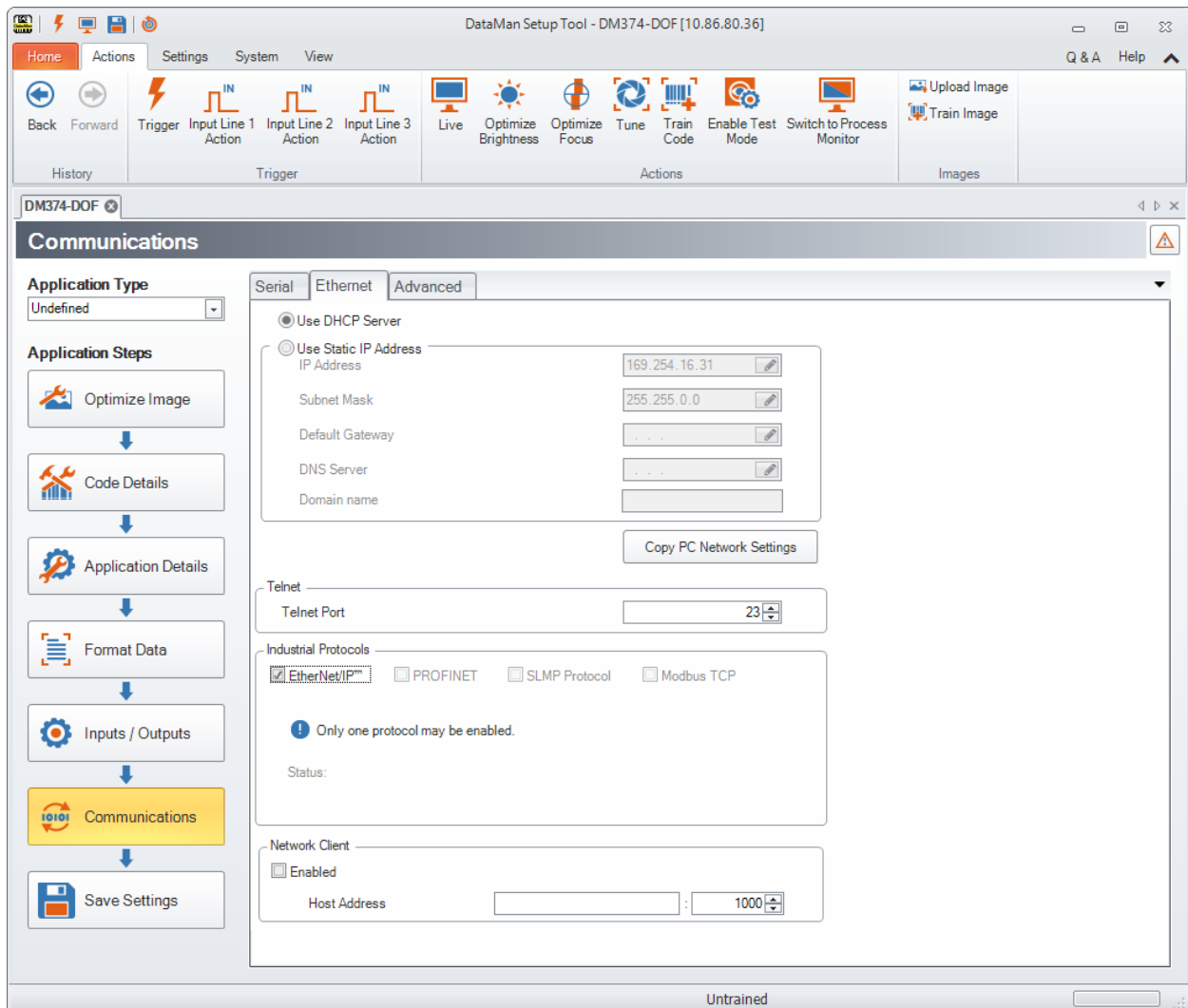

Make sure to save the new selection by clicking the **Save Settings** button in the upper toolbar before disconnecting from the reader.

Note: The new settings take effect only after the reader is rebooted.

Getting Started

Perform these steps to start using EtherNet/IP:

- Install the Rockwell Software tool.
- Set up the Rockwell Software tool so that it recognizes your DataMan device.
- Install the DataMan Electronic Data Sheet (EDS) for the DataMan reader.

Perform the following steps to set up EtherNet/IP:

1. Make sure that you select the **Add-on Profile (AOP)** installation and the **Samples** installation. The Add-on Profile is only used with Rockwell ControlLogix or CompactLogix PLCs.
2. Install the Rockwell Add-on Profiles by navigating to the following directory on Cognex.com:
<https://support.cognex.com/en/downloads/dataman/software-firmware>.

3. In the search box, type **Add-on Profile**. Click the file and download it from the following page:

The screenshot shows the Cognex website interface. At the top, there is a yellow header with the Cognex logo and contact information. Below this is a dark navigation bar with various menu items. A breadcrumb trail indicates the current page location: Home > Home > Support > DataMan > Software & Firmware > Current Software & Firmware. The main content area features a sidebar on the left with a list of product categories, and a main panel on the right titled 'ADD ON PROFILE (AOP) VERSION 1.28 FOR DATAMAN AND IN-SIGHT'. This panel lists supported DataMan series (60, 260, 200, 300/360/370, 470, 500, 8000) and In-Sight systems (2000, 5700, 7900_7500, 8000, 9000, VC200, 500, 7000, 5000, 3400, 1700, and Micro series). It also provides file details: File Type: .zip, File Size: 494.5MB, Version: 1.28, and Release Date: 9/12/2017. A blue 'DOWNLOAD' button and an 'Email a Link' button are visible at the bottom of the main panel.

4. From the Start menu, go to Programs -> Rockwell Software -> EDS Hardware Installation Tool.

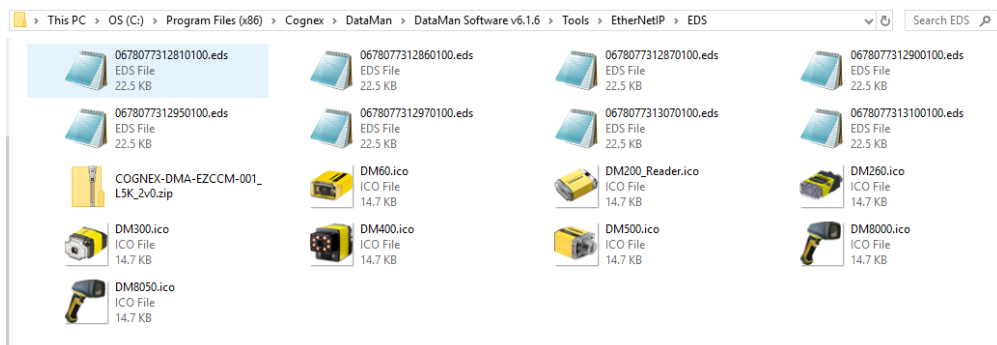
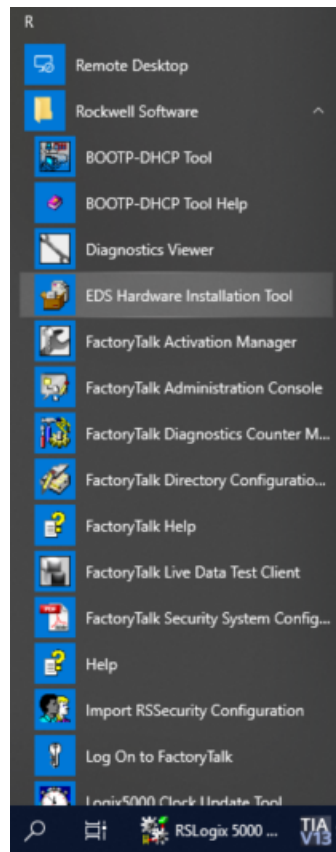

5. Run the EDS Installation Tool.

Note: If you have an existing EDS file, uninstall it first, then install the latest version of the EDS.

6. Run the DataMan Setup Tool and update the DataMan firmware.
7. Check if the DataMan firmware is up-to-date by clicking, in the Setup Tool, **View** and then **System Info**.

8. Make sure that in the Setup Tool, **EtherNet/IP** is enabled.

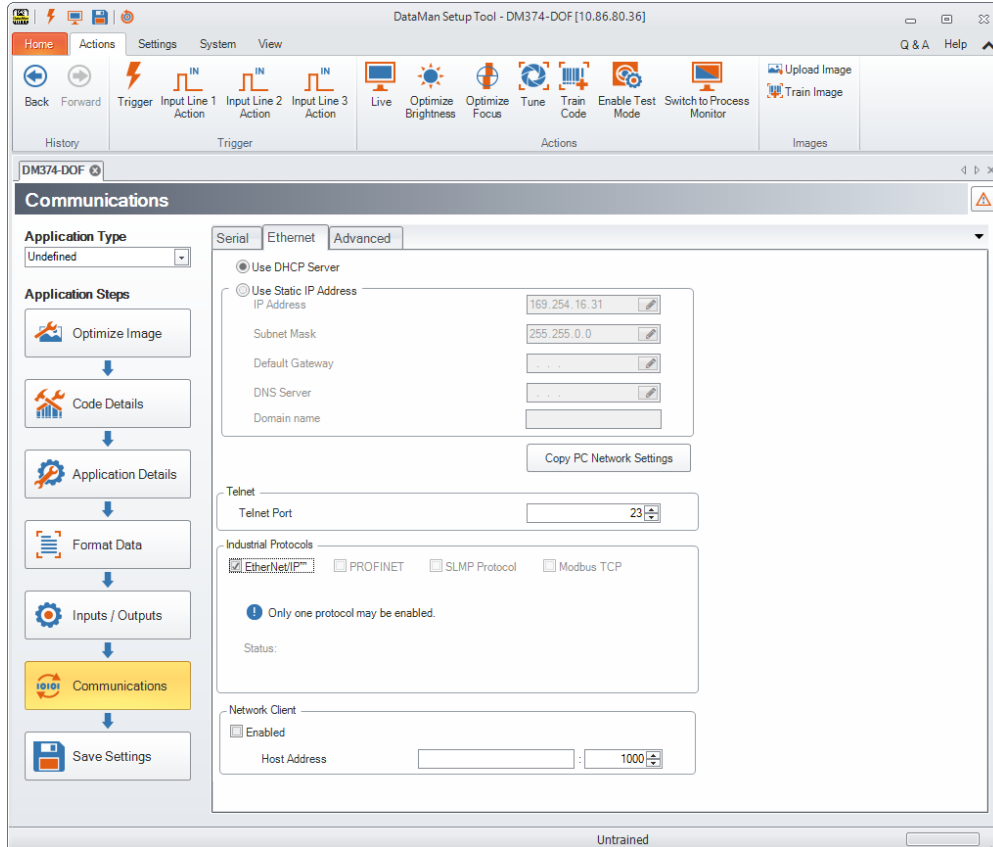

9. In order for the changes to take effect, save your settings and cycle power. Go to **System** and click **Save Settings**.

10. Reboot your reader.

11. Your DataMan is visible now in the RSLinx.

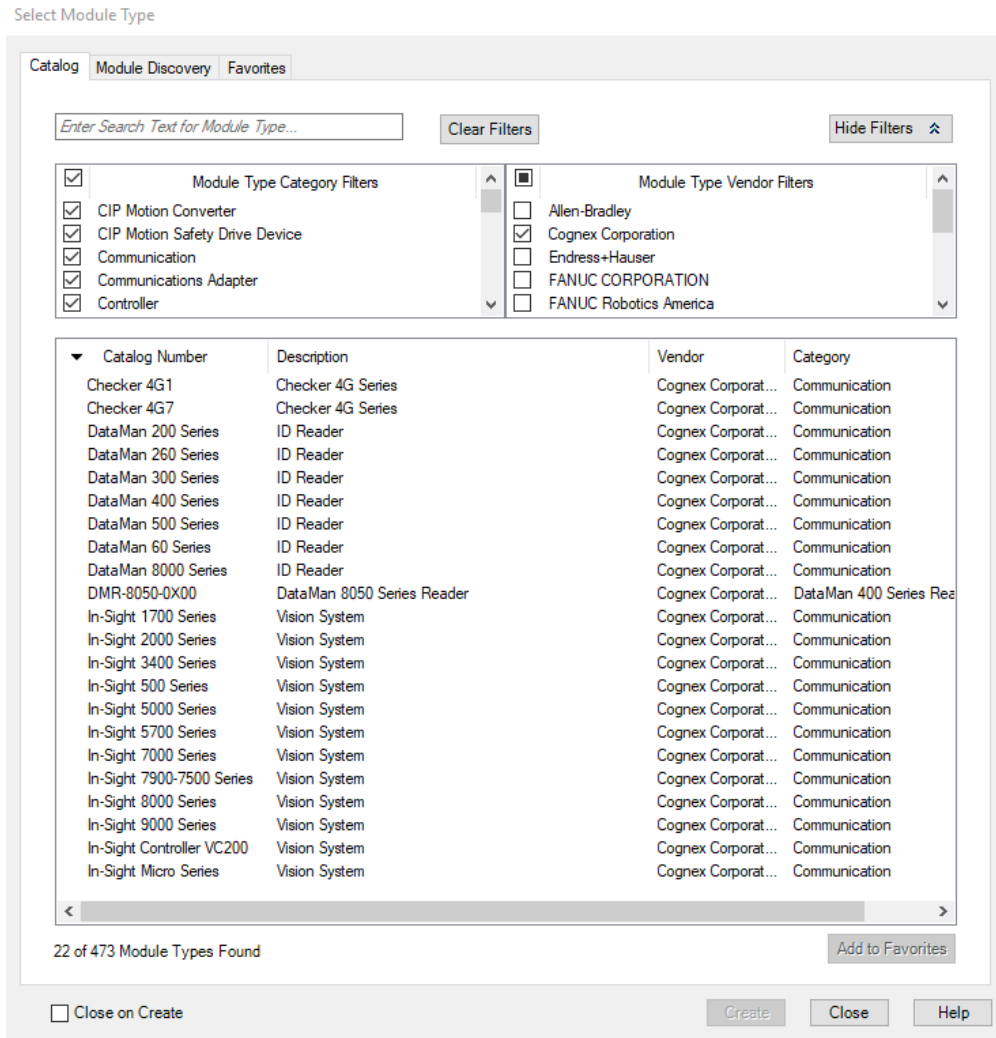

Note: If your DataMan is visible, but the icon is a question mark, repeat the EDS Installation.

12. Open one of the sample jobs and integrate your DataMan into your program using the **Add-on Profile**.

Object Model

The ID Reader Object is a vendor specific object class. This means that it is not part of the CIP common (public) architecture but an extension. It is a custom object that Cognex has added to the EtherNet/IP architecture on the DataMan device. All the data and functionality of this object model are available in the DataMan reader. This includes triggering, status, events, errors, and result data.

The ID Reader Object is identified by its vendor specific class code:

DataMan ID Reader Object Class Code: 0x79

Objects are made up of attributes (data) and services (functionality). These can be defined at the class level (common to all instances of the class) or the instance level (unique to an individual instance). The CIP specification defines common attributes and services that apply to all objects (often these are optional). Vendors may also define their own attributes and services for their vendor specific classes.

The ID Reader Object attributes and services can be individually accessed via explicit messaging. In addition, a number of the ID Reader Object attributes are exposed in the DataMan assembly objects which allow them to be accessed as a group via implicit messaging.

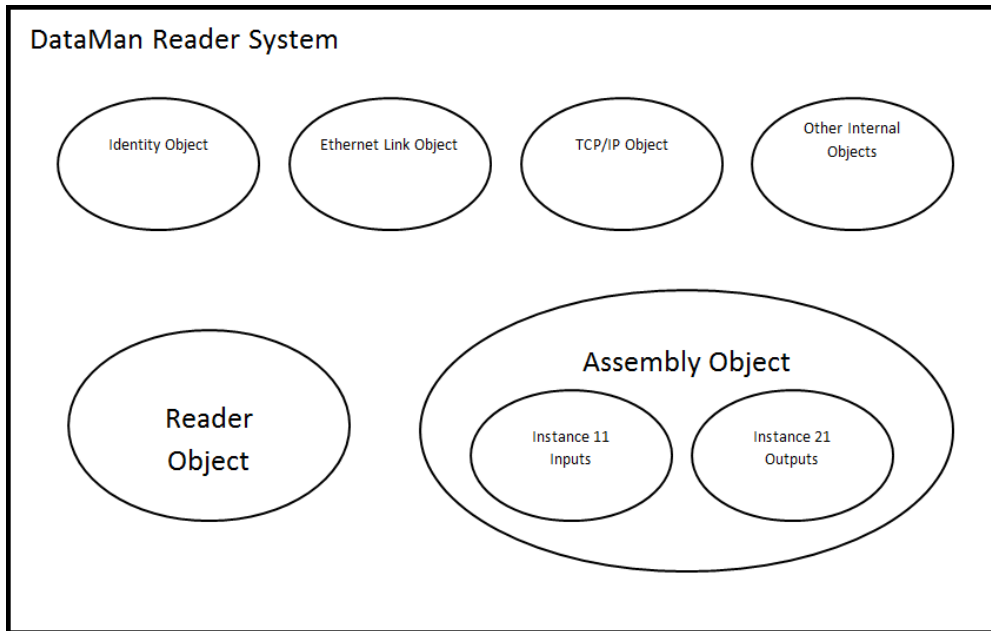

Attributes

The DataMan ID Reader Object (Class Code: 0x79) has the following attributes:

Attribute ID	Access Rule	Name	Data Type	Description
0x9	Set	AcqTriggerEnable	BOOL	0 = EtherNet/IP triggering is disabled 1 = EtherNet/IP triggering is enabled
0xA	Set	AcqTrigger	BOOL	Acquire an image when this attribute changes from 0 to 1.
0xB	Get	AcqStatusRegister	BYTE	Bit0: Trigger Ready Bit1: Trigger Ack Bit2: Reserved Bit3: Missed Acquisition Bit4-7: Reserved
0xC	Set	UserData	ARRAY of BYTE	User defined data that can be used as an input to the acquisition/decode.
0xD	Set	BufferResultsEnable	BOOL	When true, it enables buffering of the decode results.
0xE	Get	DecodeStatusRegister	BYTE	Bit0: Decoding Bit1: Decode completed (toggle) Bit2: Results buffer overrun Bit3: Results available Bit4: Reserved Bit5: Reserved Bit6: Reserved Bit7: General fault indicator
0xF	Set	ResultsAck	BOOL	Acknowledges that the client received the decode results.

Attribute ID	Access Rule	Name	Data Type	Description
0x10	Get	DecodeResults	STRUCT of	The last decode results.
		ResultsID	UINT	Decode results identifier. Corresponds to the TriggerID of the decoded image.
		ResultCode	UINT	Decode result summary code value. Bit0: 1=Read, 0=No read Bit1: 1=Validated, 0=Not Validated Bit2: 1=Verified, 0=Not Verified Bit3: 1=Acquisition trigger overrun Bit4: 1=Acquisition buffer overrun Bit5-15: Reserved (future use)
		ResultExtended	UINT	Extended result information.
		ResultLength	UINT	Current number of result data bytes.
		ResultData	ARRAY of BYTE	Result data from last decode.
0x12	Set	SoftEvents	BYTE	SoftEvents act as virtual inputs (execute action on 0 to 1 transition) Bit0: Train code Bit1: Train match string Bit2: Train focus Bit3: Train brightness Bit4: Un-Train Bit5: Reserved (future use) Bit6: Execute DMCC command Bit7: Set match string
0x15	Get	TriggerID	UNIT	Trigger identifier. ID of the next trigger to be issued.
0x16	Set	UserDataOption	UINT	Optional user data information.
0x17	Set	UserDataLength	UINT	Current number of user data bytes.
0x18	Get	SoftEventAck	BYTE	Acknowledgment of SoftEvents. Bit0: Train code ack Bit1: Train match string ack Bit2: Train focus ack Bit3: Train brightness ack Bit4: Un-Train ack Bit5: Reserved (future use) Bit6: Execute DMCC command ack Bit7: Set match string ack

SoftEvents

SoftEvents act as “virtual” inputs. When the value of a SoftEvent changes from 0 to 1, the action associated with the event is executed. When it is done, the corresponding SoftEventAck bit changes from 1 to 0 to mark completion.

The SoftEvent and SoftEventAck form a logical handshake. After SoftEventAck changes to 1 the original SoftEvent is set back to 0. When that occurs, SoftEventAck is automatically set back to 0.

The “ExecuteDMCC” and “SetMatchString” SoftEvent actions require user supplied data. This data must be written to the UserData and UserDataLength area of the Input Assembly prior to invoking the SoftEvent. Since both of these SoftEvents depend on the UserData, only one can be invoked at a time.

General Fault Indicator

When a communication related fault occurs, the “GeneralFault” bit changes from 0 to 1. The only fault conditions supported are SoftEvent operations. If a SoftEvent operation fails, the fault bit will be set. The fault bit remains set until either the next successful SoftEvent operation or until TriggerEnable is set to 0 and then back to 1.

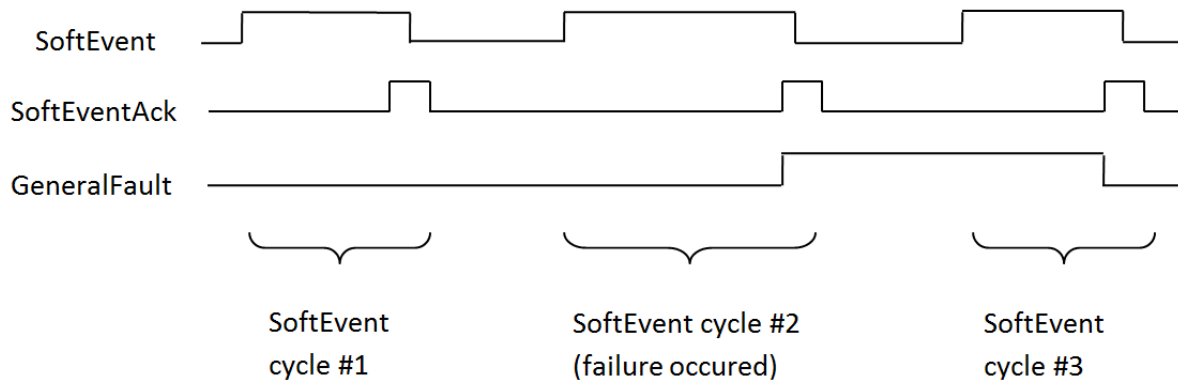

Services

The ID Reader Object supports the following Common CIP services:

Service Code	Service Name	Description
0x05	Reset	Resets the ID Reader object.
0x0E	Get_Attribute_Single	Returns the contents of the specified attribute.
0x10	Set_Attribute_Single	Modifies the specified attribute.

The ID Reader Object supports the following vendor specific services:

Service Code	Service Name	Description
0x32	Acquire	Triggers a single acquisition.
0x34	SendDMCC	Sends a DMCC command to the device.
0x35	GetDecodeResults	Gets the content of the DecodeResults attribute.

Acquire Service

The Acquire Service triggers an acquisition (if the acquisition system is ready to acquire an image). If the acquisition could not be triggered, then the Missed Acquisition bit of the AcqStatusRegister will be set until the next successful acquisition.

SendDMCC Service

The SendDMCC Service sends a DMCC command string to the device. The request data consists of the DMCC command string that is to be sent to the reader. The reply data will contain the string result of the DMCC command. Additionally, the service provides a numeric result status for the call. Most of these result codes relate to the basic success/failure of the service execution. However, the service also maps the actual DMCC status codes. This allows the PLC to interpret the service request without having to parse the actual DMCC return string.

DMCC commands transferred through the Industrial Ethernet protocols are automatically routed to the Wi-Fi reader. The commands cannot be executed while the Wi-Fi reader is powered off, hibernating, or out-of-range.

Service Return Code	Description	DMCC Return Code
0	Success – No error	0
1	Bad Command	-
4	No Answer – System too busy	-
100	Unidentified error	100
101	Command invalid	101
102	Parameter invalid	102

Service Return Code	Description	DMCC Return Code
103	Checksum incorrect	103
104	Parameter rejected/altered due to reader state	104

Note: The DMCC command string must be in the CIP STRING2 format (16-bit integer indicating the string length in characters followed by the actual string characters, no terminating null required).

GetDecodeResults Service

The GetDecodeResults service reads data from the DecodeResults attribute of the ID Reader Object. This service takes parameters indicating the “size” (number of bytes to read) and the “offset” (offset into the DecodeResults attribute to begin reading). This gives the service the flexibility to be used with PLCs that have different restrictions on the amount of data allowed in an explicit message. It also allows you to access very large codes that cannot be completely transferred with implicit messaging (assembly object).

GetDecodeResults Request Data Format

Name	Type	Description
Size	UINT	The number of bytes of the DecodeResults attribute to read.
Offset	UINT	The offset into the DecodeResults attribute. This specifies the first byte of the DecodeResults attribute to begin reading (0 based offset).

Acquisition Sequence

DataMan can be triggered to acquire images by several methods. It can be done either implicitly through the Assembly object, or done explicitly through the ID Reader object. When using explicit messaging, you can either:

- access the Acquire Service in a single step, or
- directly manipulate the ID Reader object attributes (AcqTrigger and AcqStatusRegister), or
- use DMCC commands.

The ID Reader attributes are discussed in this section. These same values can also be accessed through the assembly objects. On startup, the AcqTriggerEnable attribute is False. Set the attribute to True to enable triggering. When the device is ready to accept triggers, the Trigger Ready bit in the AcqStatusRegister is set to True.

While the AcqStatusRegister “Trigger Ready” bit is True, each time the ID Reader object sees the AcqTrigger attribute change from 0 to 1, it initiates an image acquisition. When setting the Trigger Ready bit to True through the assembly objects, make sure that the attribute is held in the new state until that same state value is seen in the Trigger Ack bit of the AcqStatusRegister (this is a necessary handshake to guarantee that the change is seen by the ID Reader object).

During an acquisition, the Trigger Ready bit in the AcqStatusRegister is cleared and the Acquiring bit is set to True. When the acquisition is completed, the Acquiring bit is cleared. The Trigger Ready bit is again set to True once the device is ready to begin a new image acquisition.

If results buffering is enabled, the device will allow overlapped acquisition and decoding operations. Trigger Ready is set high after acquisition is complete but while decoding is still in process. This can be used to achieve faster overall trigger rates. If result buffering is not enabled, the Trigger Ready bit will remain low until both the acquisition and decode operations have completed.

In certain cases, you can cancel an acquisition by clearing the Trigger signal before the read operation is finished. This allows you to cancel reads in Presentation and Manual mode if no code is in the field of view. To ensure that a read is not unintentionally cancelled, make sure that the PLC holds the Trigger signal True until both TriggerAck and ResultsAvailable are True (or DecodeComplete toggles state).

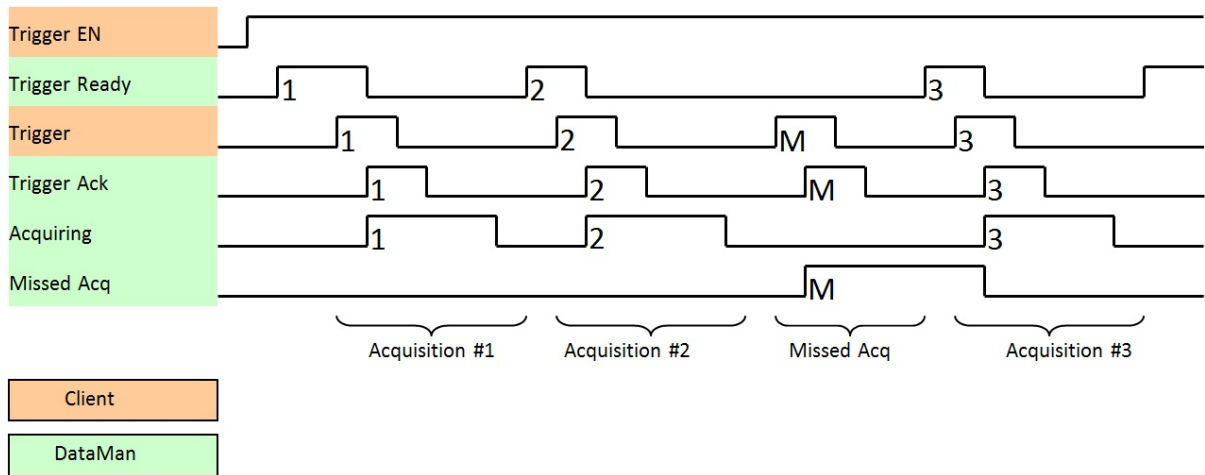

To force a reset of the trigger mechanism, set the AcqTriggerEnable attribute to False until the AcqStatusRegister is 0. Then the AcqTriggerEnable can be set to True to re-enable acquisition.

Decode / Result Sequence

After an image is acquired, it is decoded. While being decoded, the Decoding bit of the DecodeStatusRegister is set. When the decode is complete, it clears the Decoding bit and toggles the Decode Completed bit.

The BufferResultsEnable attribute determines how the ID Reader Object handles decode results. If the BufferResultsEnable attribute is set to False, then the decode results are immediately placed into the DecodeResults attribute, and Results Available is set to True.

If the BufferResultsEnable attribute is set to True, the new results are queued. The earlier decode results remain in the DecodeResults attribute until they are acknowledged by the client setting the ResultsAck attribute to True. After the Results Available bit is cleared, the client sets the ResultsAck attribute back to False to allow the next queued results to be placed in to the DecodeResults attribute. This is a necessary handshake to ensure that the DataMan reader's client (PLC) receives the results.

Behavior of DecodeStatusRegister

Bit	Bit Name	Results if Buffering Disabled	Results if Buffering Enabled
1	Decoding	Set when decoding an image.	Set when decoding an image.
2	Decode Complete	Toggled on completion of an image decode.	Toggled on completion of an image decode.
3	Results Buffer Overflow	Remains set to zero.	Set when decode results could not be queued because the client failed to acknowledge a previous result. Cleared when the decode result is successfully queued.
4	Results Available	Set when new results are placed in the DecodeResults attribute. Stays set until the results are acknowledged by setting ResultsAck to true.	Set when new results are placed in the DecodeResults attribute. Stays set until the results are acknowledged by setting ResultsAck to true.

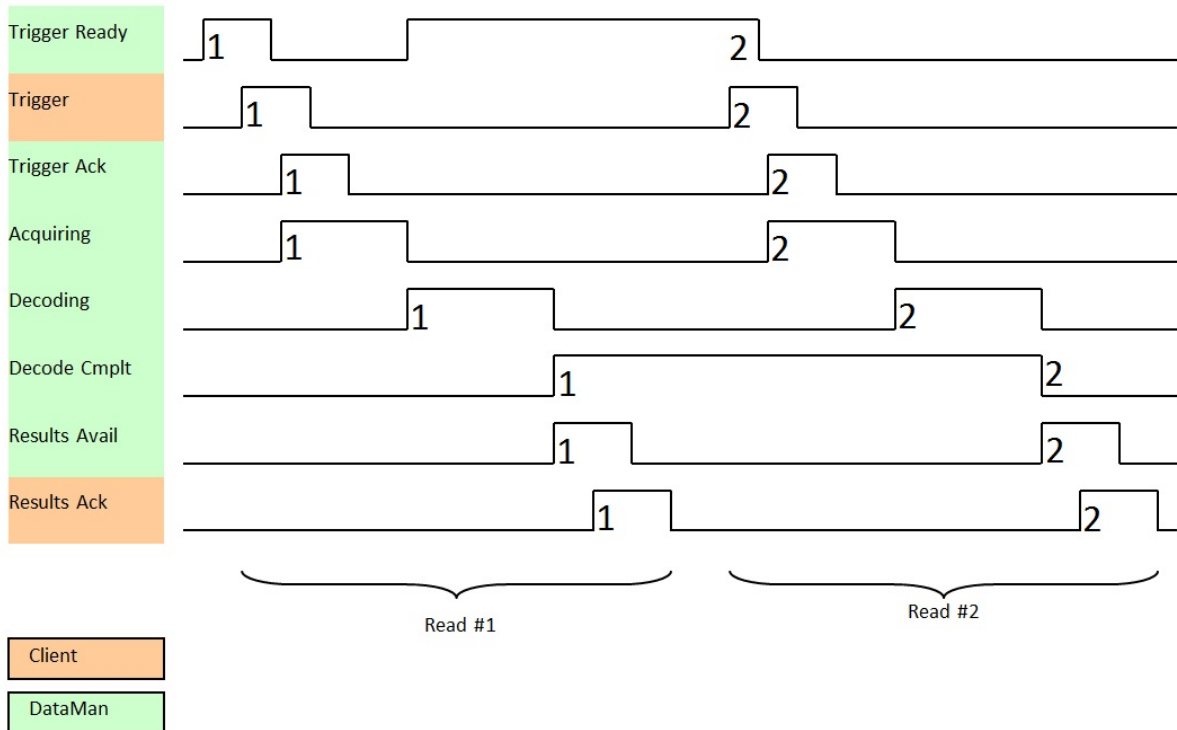

Results Buffering

There is an option to enable a queue for decode results. Enabling it allows a finite number of decode result data to queue up until the client (PLC) has time to read them. This is useful to smooth out data flow if the client (PLC) slows down for short periods of time.

If result buffering is enabled, the device will allow overlapped acquisition and decode operations. Depending on the application this can be used to achieve faster overall trigger rates. See Acquisition Sequence description above for more details.

If reads occur faster than results can be sent out, the primary difference between buffering or not buffering is determining which results get discarded. If buffering is not enabled, the most recent results are kept and the earlier result (which was not read by the PLC fast enough) is lost, because the more recent result will overwrite the earlier result. If buffering is enabled (and the queue becomes full) the most recent results are discarded until space becomes available in the results queue.

Note: If you have an overflowing queue and then disable buffering, there will be a greater than 1 difference between the TriggerID and ResultID values. This difference represents the number of reads that had occurred but could not be queued because the queue was full (number of lost reads equals TriggerID - ResultID - 1). After the next read, the ResultID value returns to the typical operating value of TriggerID - 1.

Assembly Object

Assemblies are combinations of selected attributes (data items) from CIP objects within a device. The device vendor defines assemblies according to their needs and combine data together in useful groupings according to the requirements of the application.

DataMan is an I/O adapter class device. The convention for adapters is that Input Assemblies produce (transmit) data for another device (that is, DataMan to PLC) and Output Assemblies consume (receive) data from another device (that is, PLC to DataMan). DataMan acts as an I/O module for another device such as a PLC.

Assembly objects use implicit messaging. They are blocks of data which are transmitted as the raw payload of implicit messaging packets. These implicit messaging packets are produced (transmitted) repeatedly at a predefined chosen rate (for example, 100ms or 200ms).

DataMan readers have a single input assembly and single output assembly. These assemblies combine selected attributes (data) of the DataMan ID Reader Object into groupings that minimize network bandwidth, and still allow for efficient control and processing. The data in these assemblies can also be accessed individually from the ID Reader Object. However, using the assembly objects is much more efficient, thus they are the primary means of runtime communication between a DataMan reader and a PLC.

Input Assembly

The Input assembly provides status information, process state, and decode results.

Instance	Byte	Bit 7	Bit 6	Bit 5	Bit 4	Bit 3	Bit 2	Bit 1	Bit 0
11	0	Reserved				Missed Acq	Acquiring	Trigger Ack	Trigger Ready
	1	General Fault	Reserved			Results Available	Results Buffer Overrun	Decode Complete Toggle	Decoding
	2	SoftEvent Ack 7	SoftEvent Ack 6	SoftEvent Ack 5	SoftEvent Ack 4	SoftEvent Ack 3	SoftEvent Ack 2	SoftEvent Ack 1	SoftEvent Ack 0
	3-5	Reserved							
	6	Trigger ID (16-bit integer)							
	7								
	8	Result ID (16-bit integer)							
	9								
	10	Result Code (16-bit integer)							
	11								
	12	Result Extended (16-bit integer)							
	13								
	14	Result Data Length (16-bit integer)							
	15								
	16	Result Data 0							
	...								
	499	Result Data 483							

Output Assembly

The Output assembly contains control signals, software event signals, and any user data required for the trigger and decode.

Instance	Byte	Bit 7	Bit 6	Bit 5	Bit 4	Bit 3	Bit 2	Bit 1	Bit 0
21	0	Reserved				Results Ack	Buffer Results Enable	Trigger	Trigger Enable
	1	SoftEvent 7	SoftEvent 6	SoftEvent 5	SoftEvent 4	SoftEvent 3	SoftEvent 2	SoftEvent 1	SoftEvent 0
		2	Reserved						
		3							
		4	User Data Option (16-bit integer)						
		5							
		6	User Data Length (16-bit integer)						
		7							
		8	User Data 0						
		...							
		499	User Data 491						

PCCC Object

DataMan has limited support for the Rockwell PCCC object. This allows legacy PLCs (PLC-5, SLC, and so on) to communicate with DataMan using their native PCCC command set and explicit messaging. The PCCC object allows DataMan to look like a Rockwell PLC-5 logic controller.

PCCC commands are organized to work with “data tables” that exist in legacy logic controllers. Each data table is an array of a give data type (BYTE, INT, FLOAT, and so on). The commands are oriented to read/write one or more data items of a given data table. Items are addressed by specifying the data table and the index of the item in the table (indexes base from 0). For instance, to read the 6th integer in PLC data table, you need to send the PCCC command to read N7:5. “N” specifies an integer table, “7” is the table number in the PLC (each table has a unique numeric identifier – assigned when the user PLC program was created), and “5” is the index into the table (note indexes begin at 0).

The PCCC object in DataMan maps the read and write requests to ID Reader assemblies, or in one special case to the DMCC service. Read commands return data from the Input assembly (instance 11). Write commands send data to the Output assembly (instance 21). The implementation only supports an Integer data table (N7) and an ASCII data table (A9). There is one special case of String data table (ST10:0) for DMCC.

Table	Data Type	Table Size
N7	Integer (16-bit)	250 elements
A9	ASCII (8-bit)	500 elements
ST10	String	1 element

The ResultCode value is located at word offset 5 (counting from 0) of the Input Assembly. To access this value, issue the following PLC command:

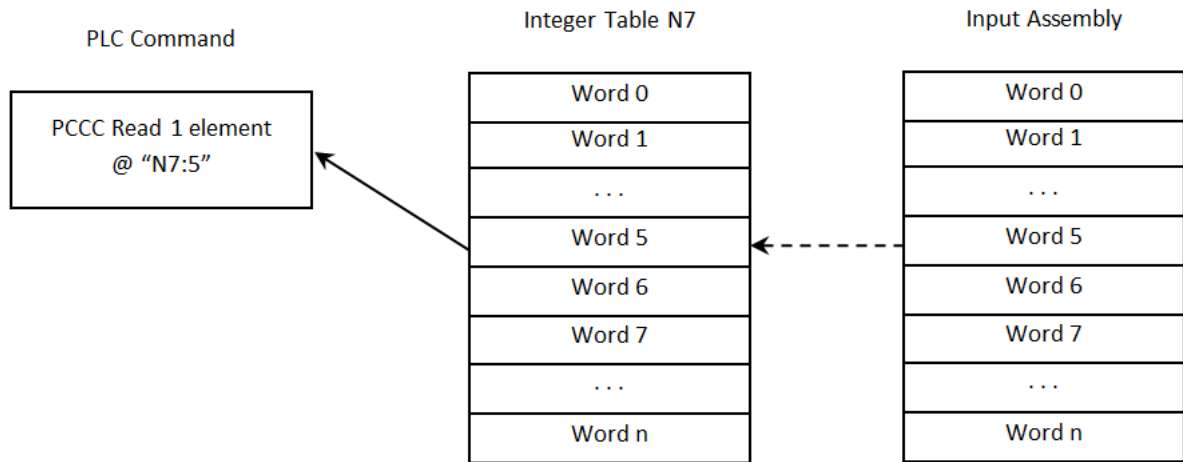

The decode ResultData begins at byte offset 16 (counting from 0) of the Input Assembly. To read the first 4 bytes of result data, issue the following PLC command:

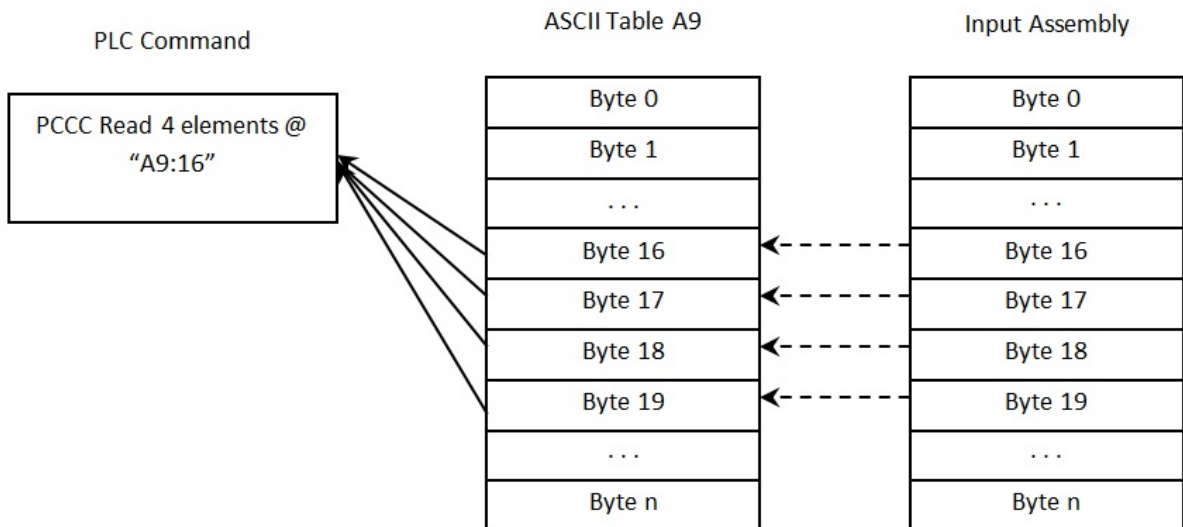

The UserData begins at word offset 4 (counting from 0) of the Output Assembly. To write 4 words of UserData, issue the following PLC command:

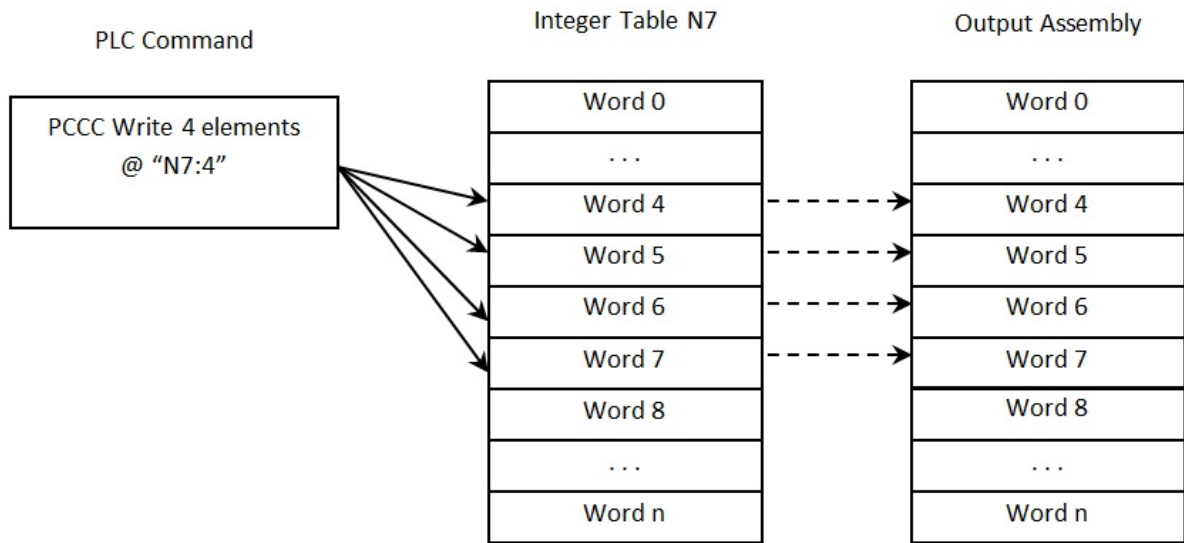

The bit to trigger an acquisition is in byte offset 0 of the Output Assembly. To write to this byte, issue the following PLC command:

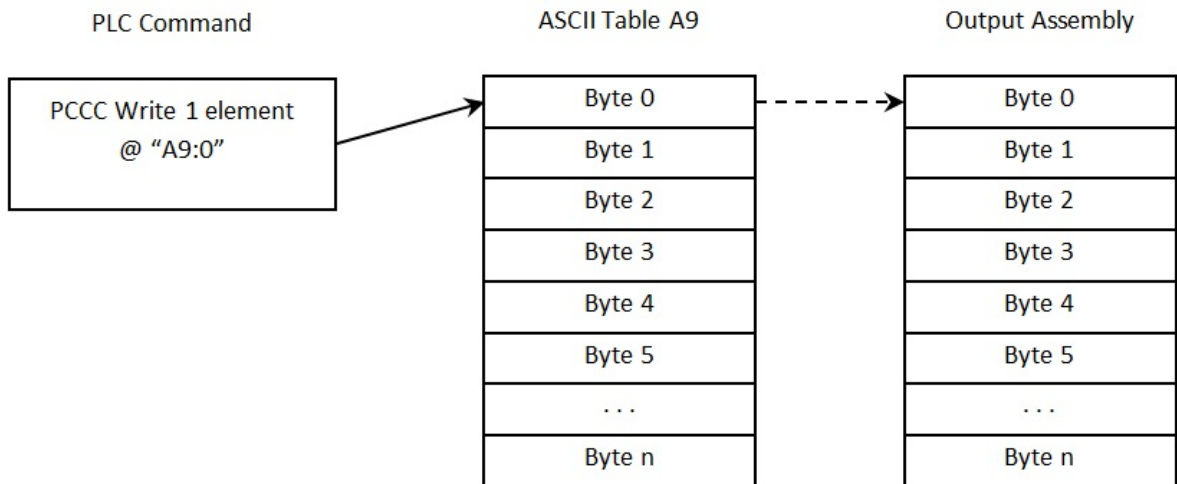

The PCCC Object supports a special case mapping of a string table element (ST10:0) to the DMCC service. Any string written to ST10:0 is passed to the DMCC service for processing. This allows PCCC write string commands to be used to invoke DMCC commands.

Note: The string table is only one element in size. Writing to the other elements will return an error.

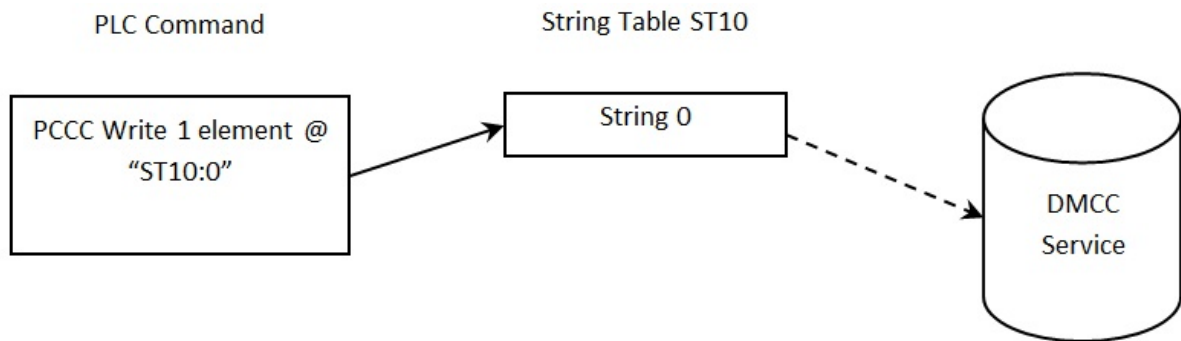

Rockwell ControlLogix Examples

Implicit messages transmit time-critical application specific I/O data and can be point-to-point or multicast. Explicit messages require a response from the receiving device. As a result, explicit messages are better suited for operations that occur less frequently. An instruction to send a DMCC command is an example of an explicit message.

Implicit Messaging

EtherNet/IP implicit messaging allows a DataMan reader's inputs and outputs to be mapped into tags in the ControlLogix PLC. Once these connections are established, the data is transferred cyclically at a user defined interval (10ms, 50ms, 100ms, and so on).

The figure below represents Ethernet-based I/O through EtherNet/IP:

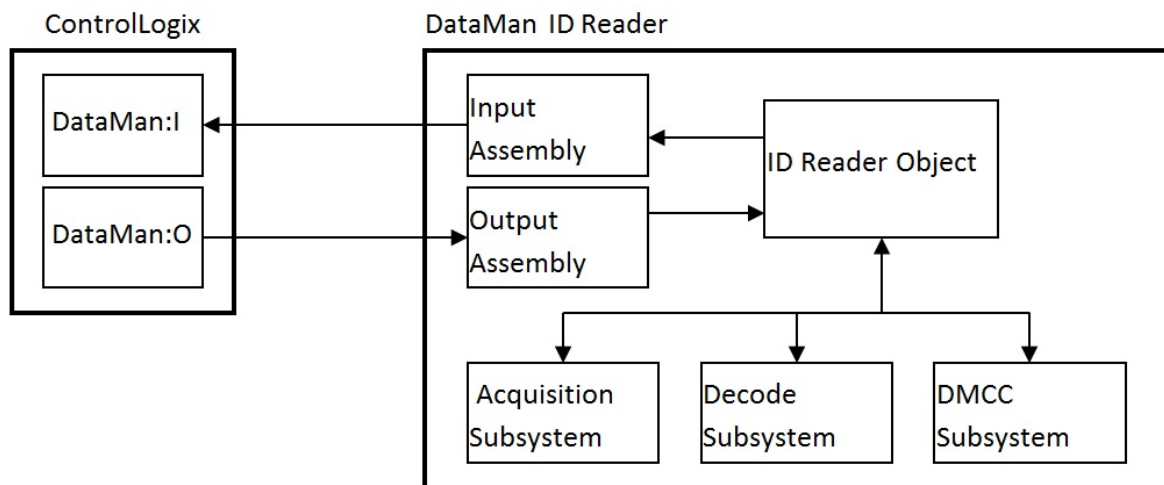

The *Input Assembly* and *Output Assembly* map various attributes (data) from the ID Reader object: The Input Assembly is the collection of DataMan reader data values sent to the PLC (PLC inputs); and the Output Assembly is the collection of data values received by the DataMan reader from the PLC (PLC outputs).

Establishing an Implicit Messaging Connection

To setup an EtherNet/IP implicit messaging connection between a DataMan and a ControlLogix controller, the DataMan reader must first be added to the ControlLogix I/O Configuration tree. The most efficient method is to use the Add-on Profile. This example assumes that the Add-on Profile has already been installed. If you do not have the Add-on Profile, see section [Using the Generic EtherNet/IP Profile](#).

To establish an implicit messaging connection with a ControlLogix PLC:

1. Open RSLogix5000 and load your project (or select "File -> New..." to create a new one). From the I/O Configuration node, select the Ethernet node under the project Ethernet Module, right-click on the

icon and select **New Module...** from the menu:

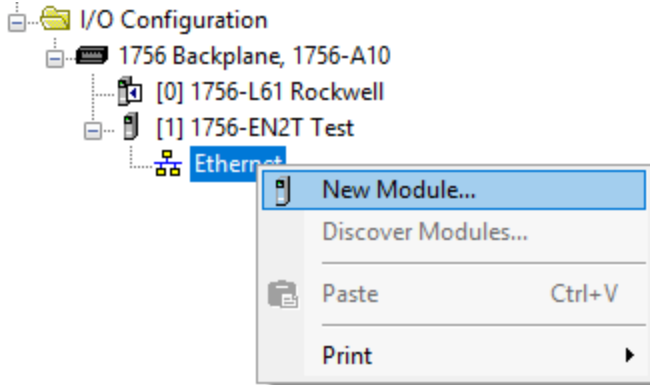

2. From the Select Module dialog, choose your model of DataMan ID Reader from the list.

Note: This option is only available after you install the DataMan Add-On Profile.

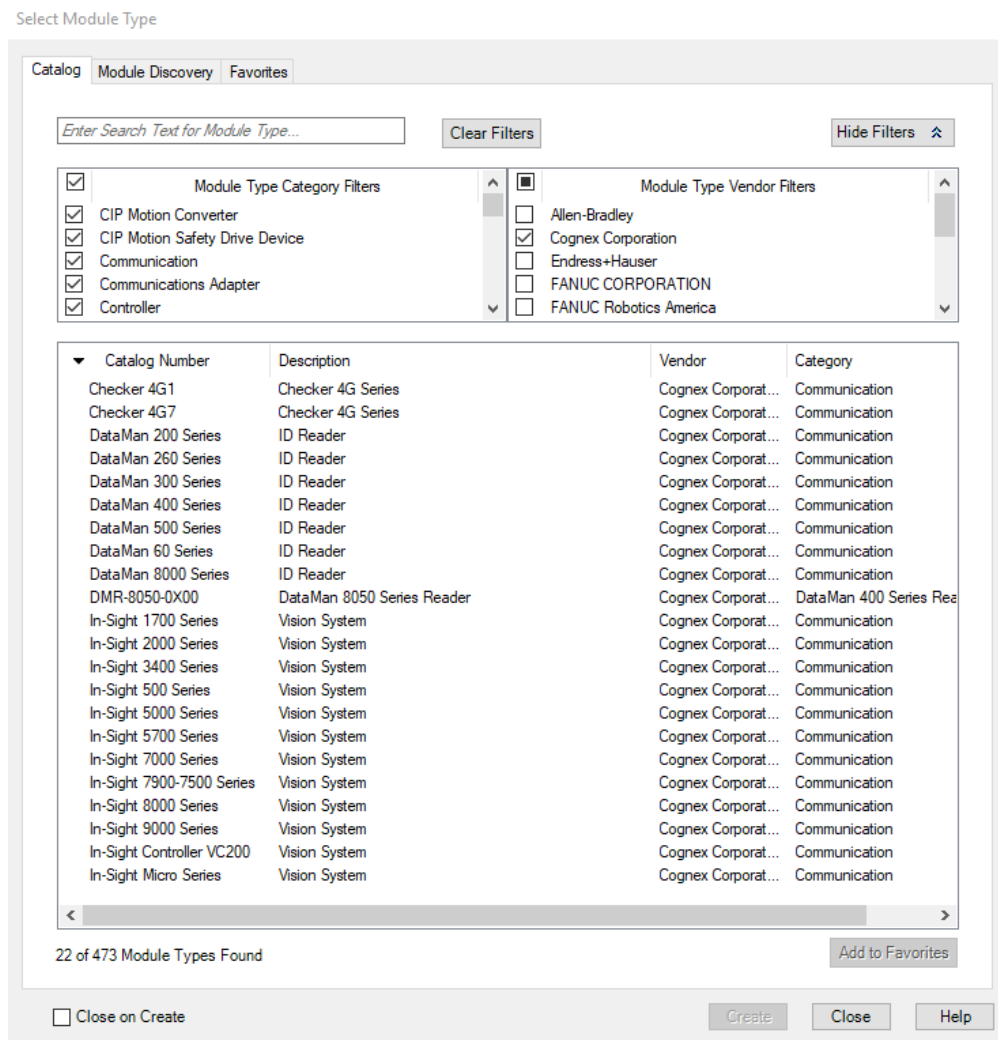

Note: The rest of the steps is identical regardless of which DataMan model is selected.

3. After selecting the device, the configuration dialog for the DataMan ID Reader system is displayed. Give the module a name and enter the DataMan's IP address. The default is a bidirectional (send/receive) connection consisting of control, status, and 32 bytes of result data with keying disabled. To change this default connection, click the **Change...** button. If no change is required, skip the next step.

The screenshot shows the 'New Module' dialog box with the following details:

- General Tab:**
 - Type: DataMan 300 Series ID Reader
 - Vendor: Cognex Corporation
 - Parent: Test
 - Name: [Empty text box]
 - Description: [Empty text box]
- Ethernet Address:**
 - Private Network: 192.168.1.
 - IP Address: [IP address input box]
 - Host Name: [Empty text box]
- Module Definition:**
 - Revision: 1.001
 - Electronic Keying: Compatible Module
 - Connection: Data (Bidirectional)
 - Input Results from Sensor: SINT-32
 - Output Data to Sensor: Control Only
- Buttons:** Change ... (next to Module Definition), OK, Cancel, Help.
- Status:** Creating

4. Clicking the **Change...** button brings up the **Module Definition** dialog. This dialog is used to alter the connection configuration. You can change:
- DataMan revision
 - Electronic keying
 - Connection type (bidirectional/receive-only)
 - Amount of data received (from the DataMan)
 - Amount of data sent (to the DataMan)

Module Definition

Revision: 1 001

Electronic Keying: Compatible Module

Connection: Data (Bidirectional)

Input Results from Sensor: SINT-32

Output Data to Sensor: Control Only

OK Cancel Help

Electronic Keying: Defines the level of module type checking that is performed by the PLC before a connection is established.

Exact Match – All of the parameters must match or the connection will be rejected.

- Vendor
- Product Type
- Catalog Number
- Major Revision
- Minor Revision

Compatible Module – To prevent the inserted module from rejecting the connection:

- The Module Types have to match
- Catalog Number has to match
- Major Revision has to match
- The Minor Revision of the module has to be equal to or greater than the one specified in the software.

Disable Keying – The controller does not employ keying at all.

Connection: Defines the type of data flow.

Data (Bidirectional) – The connection sends data to the DataMan and receives data from the DataMan.

Input (Results only) – The connection only receives data from the DataMan. If more than one PLC needs to receive data from the same DataMan device, choose the Input connection option.

Input Results from Sensor: Defines the amount of data received on the connection from the DataMan. The minimum amount is the Status data only. The connection can be configured to also receive read result data. The amount of result data received is defined in fixed increments (16 bytes, 32 bytes, 64 bytes, and so on). Select the size to return no more than the largest code size to be read by the application. Setting the size larger wastes network bandwidth and diminishes performance.

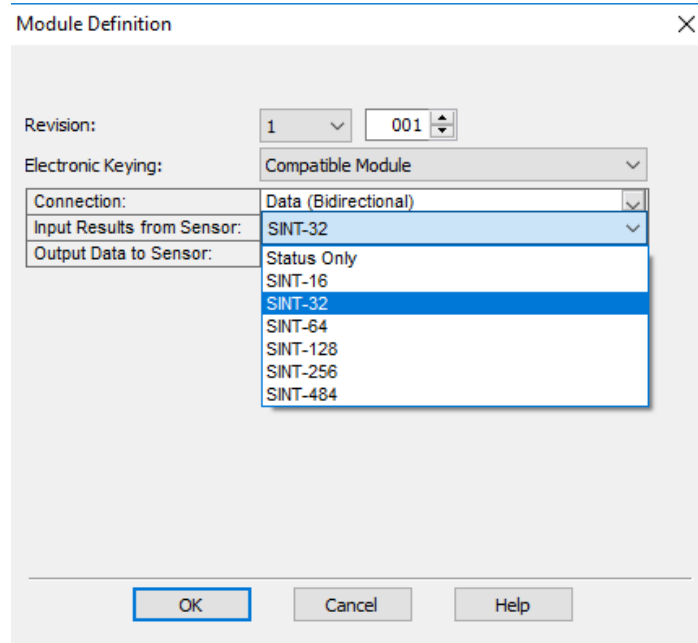

Output Data to Sensor: Defines the amount of data transmitted on the connection (to the DataMan). The minimum amount is the Control data only. The connection can be configured to also send user data. The amount of user data sent is defined in fixed increments (16 bytes, 32 bytes, 64 bytes, and so on). To enable User Data output, right-click the DataMan module and then go to Properties -> Change -> Output Data to Sensor.

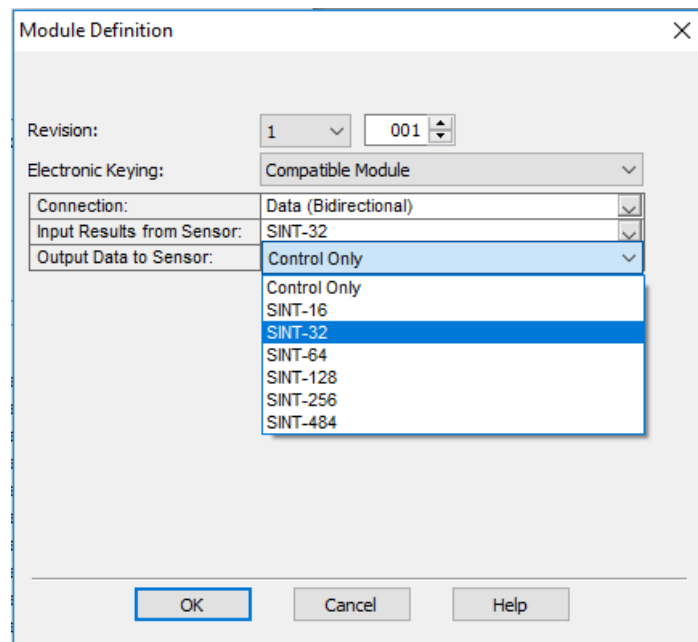

- The final step is configuring the connection rate. The rate at which data is transmitted/received is defined as the Requested Packet Interval (RPI). The RPI defines how frequently the data is transmitted/received over the connection. To optimize network performance, do not set this rate lower than required by a given application, or lower than half the expected maximum read rate of the user application. Setting it lower wastes bandwidth and does not improve processing performance.

6. Select the “Connection” tab of the “New Module” dialog to set the rate.

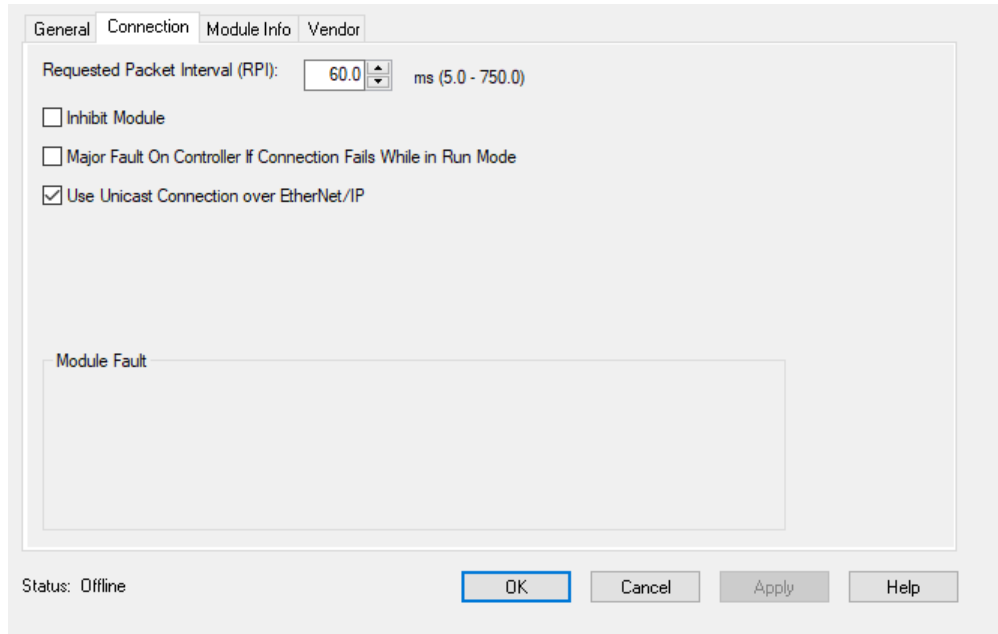

7. After adding the module to ControlLogix, the I/O tree should appear as follows:

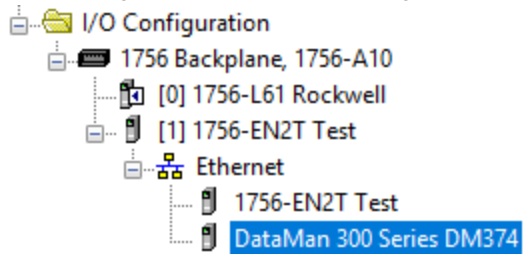

- When the DataMan module is added to the I/O tree, RSLogix 5000 creates tags that map to the DataMan reader Input and Output Data (that is, the Input and Output Assembly Objects in the DataMan Reader). These tags can be found under the “Controller Tags” node of the project tree.

Note: The base name of these tags is the name you gave to the DataMan Module that you added to the I/O Configuration in the previous steps.

Name	Value	Style	Data Type
DM374:1	{...}		CC.DataMan_SINT32:1:0
DM374:1.Status	{...}		CC.DataMan_Status:1:0
DM374:1.Status.TriggerReady	0	Decimal	BOOL
DM374:1.Status.TriggerAck	0	Decimal	BOOL
DM374:1.Status.Acquiring	0	Decimal	BOOL
DM374:1.Status.MissedAcq	0	Decimal	BOOL
DM374:1.Status.Decoding	0	Decimal	BOOL
DM374:1.Status.DecodeCompleted	0	Decimal	BOOL
DM374:1.Status.ResultsBufferOverrun	0	Decimal	BOOL
DM374:1.Status.ResultsAvailable	0	Decimal	BOOL
DM374:1.Status.GeneralFault	0	Decimal	BOOL
DM374:1.Status.TrainCodeAck	0	Decimal	BOOL
DM374:1.Status.TrainMatchStringAck	0	Decimal	BOOL
DM374:1.Status.TrainFocusAck	0	Decimal	BOOL
DM374:1.Status.TrainBrightnessAck	0	Decimal	BOOL
DM374:1.Status.UntrainAck	0	Decimal	BOOL
DM374:1.Status.ExecuteDmccAck	0	Decimal	BOOL
DM374:1.Status.SetMatchStringAck	0	Decimal	BOOL
DM374:1.Status.TriggerID	0	Decimal	INT
DM374:1.Status.ResultID	0	Decimal	INT
DM374:1.Status.ResultCode	0	Decimal	INT
DM374:1.Status.ResultExtended	0	Decimal	INT
DM374:1.Status.ResultLength	0	Decimal	INT
DM374:1.ResultData	{...}	ASCII	SINT[32]
DM374:0	{...}		CC.DataMan_SINT32:0:0
DM374:0.Control	{...}		CC.DataMan_Control:0:0
DM374:0.Control.TriggerEnable	0	Decimal	BOOL
DM374:0.Control.Trigger	0	Decimal	BOOL
DM374:0.Control.ResultsBufferEnable	0	Decimal	BOOL
DM374:0.Control.ResultsAck	0	Decimal	BOOL
DM374:0.Control.TrainCode	0	Decimal	BOOL
DM374:0.Control.TrainMatchString	0	Decimal	BOOL
DM374:0.Control.TrainFocus	0	Decimal	BOOL
DM374:0.Control.TrainBrightness	0	Decimal	BOOL
DM374:0.Control.Untrain	0	Decimal	BOOL
DM374:0.Control.ExecuteDMCC	0	Decimal	BOOL
DM374:0.Control.SetMatchString	0	Decimal	BOOL
DM374:0.Control.UserDataOption	0	Decimal	INT
DM374:0.Control.UserDataLength	0	Decimal	INT
DM374:0.UserData	{...}	ASCII	SINT[32]

The tags are organized in two groups: Status and Control. The Status group represents all the data being received from the DataMan. The Control group represents all the data being sent to the DataMan.

These tags are the symbolic representation of the DataMan Assembly Object contents. The PLC ladder is written to access these tag values. By monitoring or changing these tag values the PLC ladder is monitoring and changing the DataMan Assembly Object contents.

Note: Based on the configured RPI, there is a time delay between the DataMan and the PLC tag values. Take this time delay into account when writing all PLC ladders.

Accessing Implicit Messaging Connection Data

One aspect of the Add-on Profile is that it automatically generates ControlLogix tags representing the connection data.

The generated tags are divided into two groups: Status and Control. The Status group represents all the data being received from the DataMan. The Control group represents all the data being sent to the DataMan.

Status tag group is the data the ControlLogix receives from the DataMan reader:

DM374:I	{...}		CC:DataMan_SINT32:I:0
DM374:I.Status	{...}		CC:DataMan_Status:I:0
DM374:I.Status.TriggerReady	0	Decimal	BOOL
DM374:I.Status.TriggerAck	0	Decimal	BOOL
DM374:I.Status.Acquiring	0	Decimal	BOOL
DM374:I.Status.MissedAcq	0	Decimal	BOOL
DM374:I.Status.Decoding	0	Decimal	BOOL
DM374:I.Status.DecodeCompleted	0	Decimal	BOOL
DM374:I.Status.ResultsBufferOverrun	0	Decimal	BOOL
DM374:I.Status.ResultsAvailable	0	Decimal	BOOL
DM374:I.Status.GeneralFault	0	Decimal	BOOL
DM374:I.Status.TrainCodeAck	0	Decimal	BOOL
DM374:I.Status.TrainMatchStringAck	0	Decimal	BOOL
DM374:I.Status.TrainFocusAck	0	Decimal	BOOL
DM374:I.Status.TrainBrightnessAck	0	Decimal	BOOL
DM374:I.Status.UntrainAck	0	Decimal	BOOL
DM374:I.Status.ExecuteDmccAck	0	Decimal	BOOL
DM374:I.Status.SetMatchStringAck	0	Decimal	BOOL
DM374:I.Status.TriggerID	0	Decimal	INT
DM374:I.Status.ResultID	0	Decimal	INT
DM374:I.Status.ResultCode	0	Decimal	INT
DM374:I.Status.ResultExtended	0	Decimal	INT
DM374:I.Status.ResultLength	0	Decimal	INT
DM374:I.ResultData	{...}	ASCII	SINT[32]

- **TriggerReady:** Indicates when the DataMan reader can accept a new trigger. This tag is True when the Control tag “TriggerEnable” has been set , and the sensor is not acquiring an image.
- **TriggerAck:** Indicates when the DataMan reader has been triggered (that is, the Control tag “Trigger” has been set to True). This tag stays set until the Trigger tag is cleared.
- **Acquiring:** Indicates when the DataMan reader is acquiring an image either by setting the Trigger bit or by an external trigger.
- **MissedAcq:** Indicates when the DataMan reader misses an acquisition trigger. It is cleared when the next successful acquisition occurs.
- **Decoding:** Indicates when the DataMan reader is decoding an acquired image.
- **DecodeCompleted:** Tag value is toggled (1 to 0 or 0 to 1) when a decode is completed.
- **ResultsBufferOverrun:** Indicates when the DataMan reader discards a set of decode results because the results queue is full. Cleared when the next set of results are successfully queued.
- **ResultsAvailable:** Indicates when a set of decode results are available (that is, the ResultID, ResultCode, ResultLength and ResultsData tags contain valid data).
- **GeneralFault:** Indicates when a fault has occurred (that is, SoftEvent “SetMatchString” or “ExecuteDMCC” error has occurred).
- **TrainCodeAck:** Indicates that the SoftEvent “TrainCode” is complete.
- **TrainMatchStringAck:** Indicates that the SoftEvent “TrainMatchString” has completed.
- **TrainFocusAck:** Indicates that the SoftEvent “TrainFocus” has completed.
- **TrainBrightnessAck:** Indicates that the SoftEvent “TrainBrightness” has completed.
- **UnTrainAck:** Indicates that the SoftEvent “UnTrain” has completed.
- **ExecuteDmccAck:** Indicates that the SoftEvent “ExecutedDMCC” has completed.
- **SetMatchStringAck:** Indicates that the SoftEvent “SetMatchString” has completed.
- **TriggerID:** Value of the next trigger to be issued. Used to match triggers issued with corresponding result data received later.

- **ResultID**: The value of TriggerID when the trigger that generated these results was issued. Used to match TriggerID's with result data.
- **ResultCode**: Indicates success/failure of this set of results.
 - **Bit 0** ,1=read 0=no read
 - **Bit 1** ,1=validated 0=not validated (or validation not in use)
 - **Bit 2** ,1=verified 0=not verified (or verification not in use)
 - **Bit 3** ,1=acquisition trigger overrun
 - **Bit 4** ,1=acquisition buffer overflow (not the same as result buffer overflow).
 - **Bits 5-15** , reserved (future use)
- **ResultExtended**: Unused.
- **ResultLength**: Number of bytes of result data contained in the ResultData tag.
- **ResultData**: Decode result data. Control tag group is the data sent from the ControlLogix to the DataMan reader:

[-] DM374:0	{...}		CC:DataMan_SINT32:0:0
[-] DM374:0.Control	{...}		CC:DataMan_Control0:0
[-] DM374:0.Control.TriggerEnable	0	Decimal	BOOL
[-] DM374:0.Control.Trigger	0	Decimal	BOOL
[-] DM374:0.Control.ResultsBufferEnable	0	Decimal	BOOL
[-] DM374:0.Control.ResultsAck	0	Decimal	BOOL
[-] DM374:0.Control.TrainCode	0	Decimal	BOOL
[-] DM374:0.Control.TrainMatchString	0	Decimal	BOOL
[-] DM374:0.Control.TrainFocus	0	Decimal	BOOL
[-] DM374:0.Control.TrainBrightness	0	Decimal	BOOL
[-] DM374:0.Control.Untrain	0	Decimal	BOOL
[-] DM374:0.Control.ExecuteDMCC	0	Decimal	BOOL
[-] DM374:0.Control.SetMatchString	0	Decimal	BOOL
[+] DM374:0.Control.UserDataOption	0	Decimal	INT
[+] DM374:0.Control.UserDataLength	0	Decimal	INT
[+] DM374:0.UserData	{...}	ASCII	SINT[32]

- **TriggerEnable**: Setting this tag enables EtherNet/IP triggering. Clearing this field disables the EtherNet/IP triggering.
- **Trigger**: Setting this tag triggers an acquisition if:
 - The TriggerEnable tag is set.
 - No acquisition/decode is currently in progress.
 - The device is ready to trigger.
- **ResultsBufferEnable**: When set, the decode results are queued. Results are made available each time the PLC acknowledges the current results. The Decode ID, Decode Result and Decode ResultsData fields are held constant until the ResultsAck field acknowledged and set them. The DataMan reader responds to the acknowledgment by clearing the ResultsValid bit. Once the ResultsAck field is cleared, the next set of decode results are posted.
- **ResultsAck**: The ResultsAck tag is used to acknowledge that the PLC read the latest results. When ResultsAck is set, the ResultsAvailable tag will be cleared. If results buffering is enabled, the next set of results are made available when the ResultsAck tag is cleared again.
- **TrainCode**: Changing this tag from 0 to 1 invokes the train code operation.
- **TrainMatchString**: Changing this tag from 0 to 1 invokes the train match string operation.
- **TrainFocus**: Changing this tag from 0 to 1 invokes the train focus operation.

- **TrainBrightness:** Changing this tag from 0 to 1 invokes the train brightness operation.
- **Untrain:** Changing this tag from 0 to 1 invokes the un-train operation.
- **ExecuteDMCC:** Changing this tag from 0 to 1 invokes the DMCC operation. A valid DMCC command string must be written to UserData prior to invoking this SoftEvent.
- **SetMatchString:** Changing this tag from 0 to 1 invokes the set match string operation. The match string data must be written to UserData prior to invoking this SoftEvent.
- **UserDataOption:** Unused.
- **UserDataLength:** Number of bytes of user data contained in the UserData tag.
- **UserData:** This data is sent to the DataMan reader to support acquisition and/or decode.



Note:

Configure the DataMan module in RSLogix 5000 to manually add **UserData** to the output assembly.

Perform the following steps on a CompactLogix or ControlLogix PLC:

1. Right click the DataMan module and select **Properties**.
2. Under **Module Definition**, click **Change**.
3. The Module Definition window pops up. Under the **Output Data to Sensor** drop-down menu, select **SINT-484**.
4. Click **OK**. RSLogix 500 is now updating the Module Definition.

The output assembly controller tags now list UserData as part of the output assembly.

Verifying Implicit Messaging Connection Operation

After the DataMan is added as an I/O device in a ControlLogix project and the project is downloaded to the controller, the I/O connection needs to be established. Once a successful connection is established, cyclic data transfers are initiated at the requested RPI.

To verify a proper I/O connection, follow these steps:

1. Download the project to the ControlLogix controller.
2. When the download completes, the project I/O indicator is **I/O OK**, indicating that the I/O connection is successfully completed.

To verify the correct, two-way transfer of I/O data, go to the controller tags in RSLogix and change the state of the TriggerEnable bit from 0 to 1:

[-] DM374:0	{...}		CC:DataMan_SINT32:0:0
[-] DM374:0.Control	{...}		CC:DataMan_Control:0:0
[-] DM374:0.Control.TriggerEnable	1	Decimal	BOOL
[-] DM374:0.Control.Trigger	0	Decimal	BOOL
[-] DM374:0.Control.ResultsBufferEnable	0	Decimal	BOOL
[-] DM374:0.Control.ResultsAck	0	Decimal	BOOL
[-] DM374:0.Control.TrainCode	0	Decimal	BOOL
[-] DM374:0.Control.TrainMatchString	0	Decimal	BOOL
[-] DM374:0.Control.TrainFocus	0	Decimal	BOOL
[-] DM374:0.Control.TrainBrightness	0	Decimal	BOOL
[-] DM374:0.Control.Untrain	0	Decimal	BOOL
[-] DM374:0.Control.ExecuteDMCC	0	Decimal	BOOL
[-] DM374:0.Control.SetMatchString	0	Decimal	BOOL
[+] DM374:0.Control.UserDataOption	0	Decimal	INT
[+] DM374:0.Control.UserDataLength	0	Decimal	INT

3. The TriggerReady tag changes to 1. Triggering is now enabled.
4. Whenever the Trigger tag is changed from 0 to 1, the DataMan reader acquires an image.

Note: The current TriggerID value is 1. Make sure that the results of the next trigger to be issued come back with a corresponding ResultID of 1.

- After the acquisition/decode has completed, the DecodeCompleted tag will toggle, and the ResultsAvailable tag goes to 1. This example shows a successful read (ResultCode bit 0 = 1) and the read has returned 16 bytes of data (ResultLength=16). The data is in the ResultData tag.

Name	Value	Style	Data Type
DM374:I	{...}		CC:DataMan_SINT32:I:0
DM374:I.Status	{...}		CC:DataMan_Status:I:0
DM374:I.Status.TriggerReady	1	Decimal	BOOL
DM374:I.Status.TriggerAck	0	Decimal	BOOL
DM374:I.Status.Acquiring	0	Decimal	BOOL
DM374:I.Status.MissedAcq	0	Decimal	BOOL
DM374:I.Status.Decoding	0	Decimal	BOOL
DM374:I.Status.DecodeCompleted	1	Decimal	BOOL
DM374:I.Status.ResultsBufferOverrun	0	Decimal	BOOL
DM374:I.Status.ResultsAvailable	1	Decimal	BOOL
DM374:I.Status.GeneralFault	0	Decimal	BOOL
DM374:I.Status.TrainCodeAck	0	Decimal	BOOL
DM374:I.Status.TrainMatchStringAck	0	Decimal	BOOL
DM374:I.Status.TrainFocusAck	0	Decimal	BOOL
DM374:I.Status.TrainBrightnessAck	0	Decimal	BOOL
DM374:I.Status.UntrainAck	0	Decimal	BOOL
DM374:I.Status.ExecuteDmccAck	0	Decimal	BOOL
DM374:I.Status.SetMatchStringAck	0	Decimal	BOOL
DM374:I.Status.TriggerID	297	Decimal	INT
DM374:I.Status.ResultID	296	Decimal	INT
DM374:I.Status.ResultCode	1	Decimal	INT
DM374:I.Status.ResultExtended	0	Decimal	INT
DM374:I.Status.ResultLength	16	Decimal	INT
DM374:I.ResultData	{...}	ASCII	SINT[32]
DM374:O	{...}		CC:DataMan_NODATA:O:0
DM374:O.Control	{...}		CC:DataMan_Control:O:0
DM374:O.Control.TriggerEnable	0	Decimal	BOOL
DM374:O.Control.Trigger	0	Decimal	BOOL
DM374:O.Control.ResultsBufferEnable	0	Decimal	BOOL
DM374:O.Control.ResultsAck	0	Decimal	BOOL
DM374:O.Control.TrainCode	0	Decimal	BOOL

Explicit Messaging

Unlike implicit messaging, explicit messages are sent to a specific device that always sends a reply to that message. As a result, explicit messages are better suited for operations that occur infrequently. Explicit messages can be used to read and write the attributes (data) of the ID Reader Object. They can also be used for acquiring images, sending DMCC commands and retrieving result data.

Issuing DMCC Commands

One of the more common explicit messages sent to a DataMan ID Reader is an instruction to execute a DMCC command. Explicit messages are sent from ControlLogix to a DataMan using MSG instructions. There are two different paths for invoking DMCC messages with explicit messaging: through the PCCC Object, or through the ID Reader Object "SendDMCC" service. The example shows the SendDMCC service.

The CIP STRING2 format is required for transmission across EtherNet/IP: a 16-bit length value followed by actual string characters, no null terminator. Logix stores strings in a slightly different format: a 32-bit length value followed by actual string characters, no null terminator. Therefore, some of the sample ladder involves converting to/from the two different string formats.

Note: The instruction to send a DMCC is intended as a demonstration of DataMan explicit messaging behavior. This same operation could be written in a much more efficient ladder but would be less useful as a learning tool.

1. Add the following tags to the ControlLogix Controller Tags dialog:

Name	Data Type	Style
Send_DMCC_Command	BOOL	Decimal
+ DMCC_Command_String	STRING	
+ DMCC_Result_String	STRING	
+ Message_Data	SINT[128]	Decimal
+ Message_Result	SINT[128]	Decimal
Message_Pending	BOOL	Decimal
+ MSG_DMCC	MESSAGE	

- **Send_DMCC_Command:** Boolean flag used to initiate the command.
- **DMCC_Command_String:** String containing the DMCC command to execute.
- **DMCC_Result_String:** String receiving the DMCC command results.
- **Message_Data:** Temp buffer holding the data to send via the MSG instruction.
- **Message_Result:** Temp buffer holding the data received via the MSG instruction.
- **Message_Pending:** Boolean flag used to indicate that a message is in process.
- **MSG_DMCC:** Data structure required by the Logix MSG instruction.

2. Add the following two rungs to the MainRoutine of your ControlLogix project:

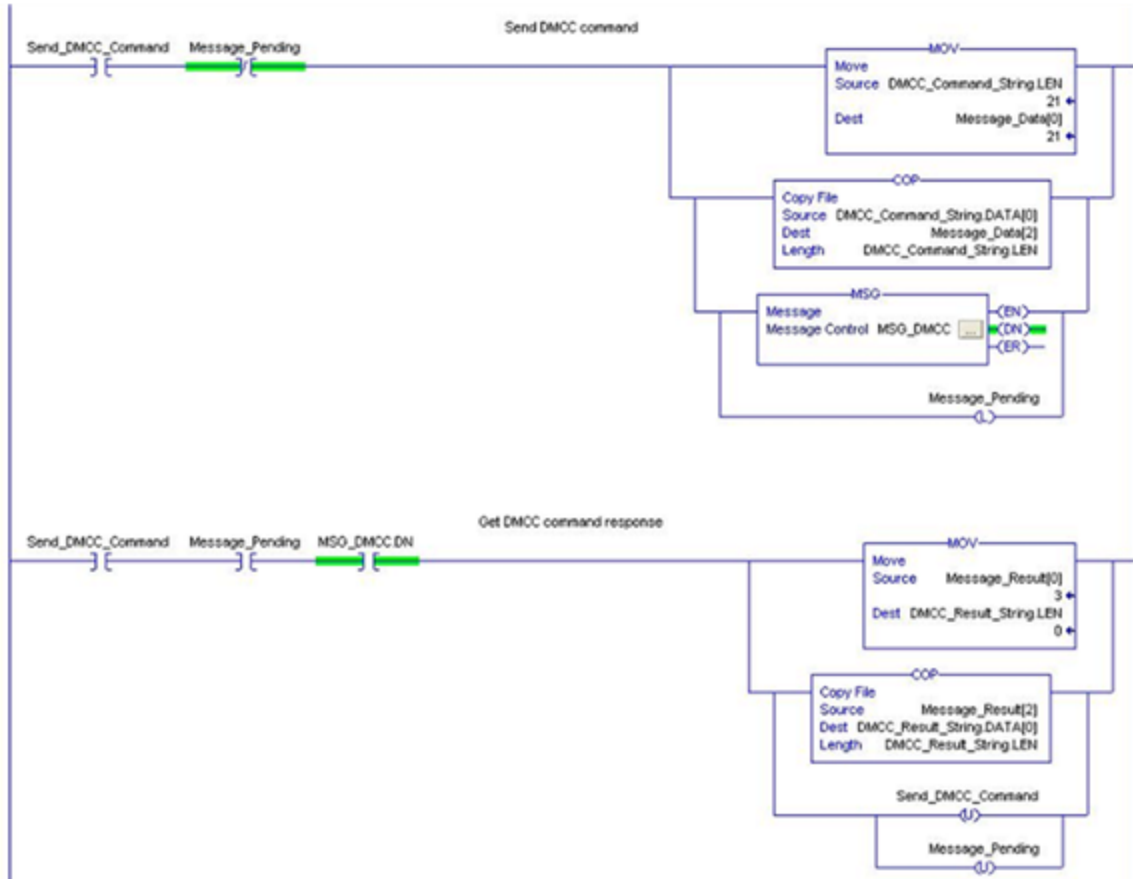

3. Edit the MSG instruction. Configure it for “CIP Generic”, service 0x34 “SendDMCC”, class 0x79 “ID Reader Object” and instance 1. Set the source to “Message_Data” and the destination to “Message_Result”.



- On the MSG instruction **Communication** tab, browse for and select the DataMan which you added to the project I/O Configuration tree. This tells Logix where to send the explicit message.

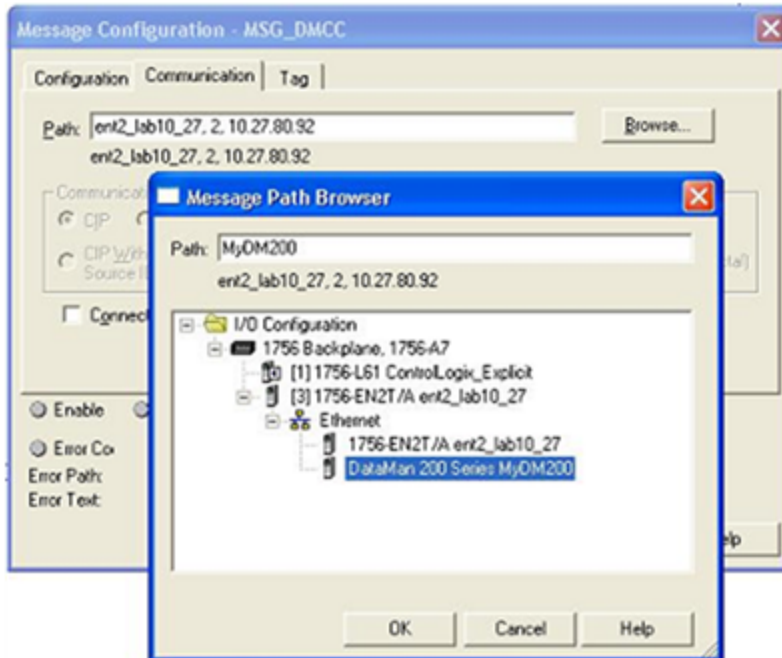

- Download the project to the ControlLogix and place in "Run Mode".

To operate:

- Place a DMCC command in the "DMCC_Command_String" tag. For example "|>GET TRIGGER.TYPE\$r\$I". Note the \$r\$I at the end of the string. This is how Logix represents a CRLF.
- Toggle the "Send_DMCC_Command" tag to 1.
- When the "Send_DMCC_Command" tag goes back to 0 execution is complete. The DMCC command results can be found in "DMCC_Result_String".

Rockwell CompactLogix Examples

In the CompactLogix project, the Ethernet logic module is embedded in the CompactLogix processor module. It is displayed in the I/O Configuration tree as if it were a separate module on the backplane. This module is configured exactly like a ControlLogix Ethernet module.

The DataMan module is added in the same way for CompactLogix as for ControlLogix. Perform the following steps:

1. Right-click the Ethernet node in the I/O Configuration tree and select **New Module....**

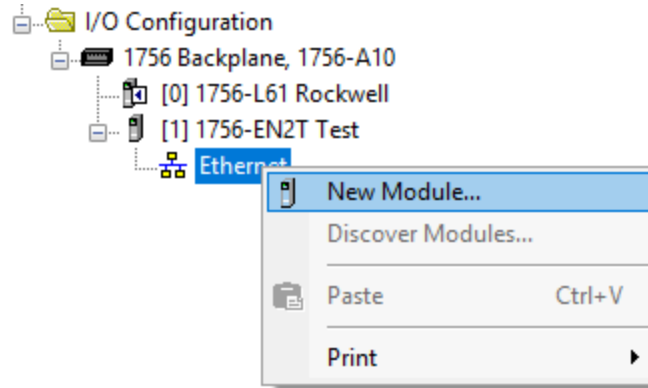

2. From the **Select Module** dialog, choose your model of DataMan ID Reader from the list.

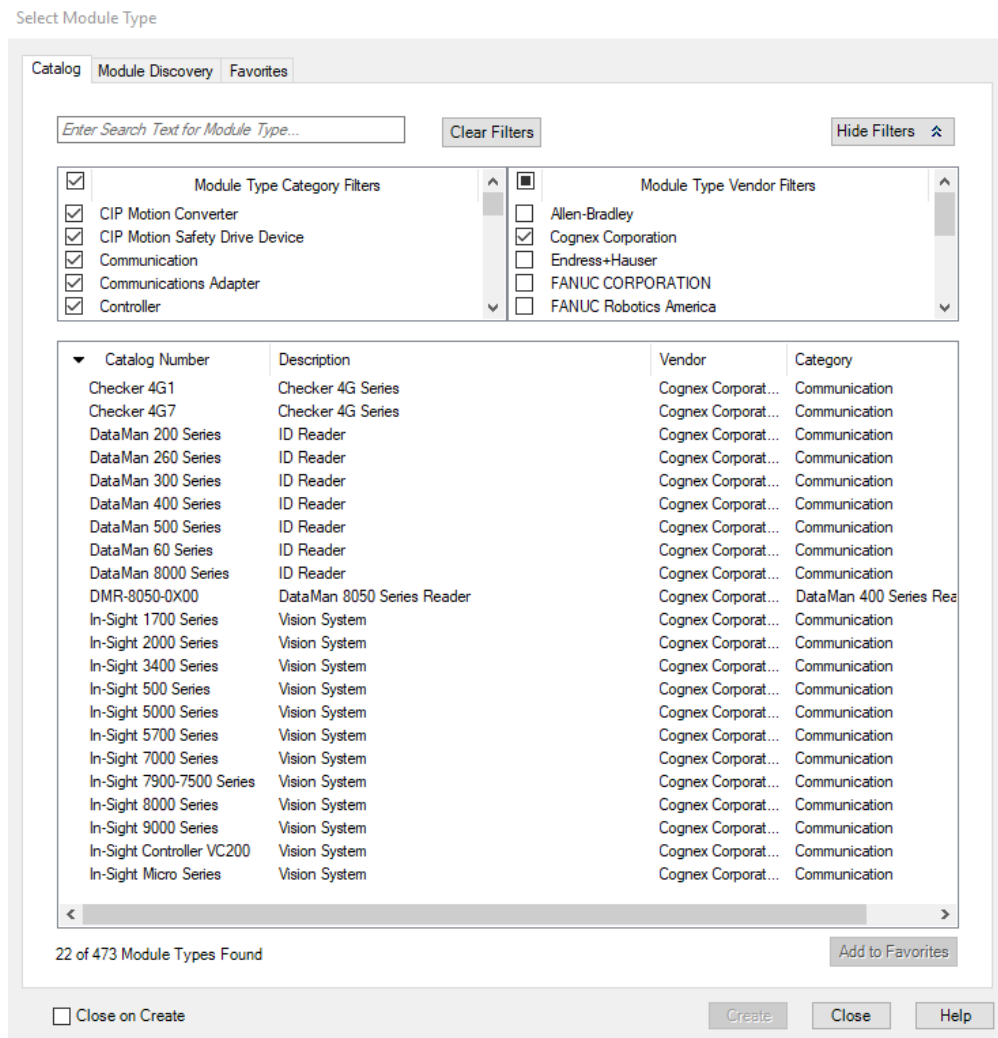

After the selection is completed, the configuration dialog for the DataMan ID Reader system is displayed. From this point on, configuration and programming are done exactly as shown in the [ControlLogix](#) section above.

Rockwell SLC 5/05 Example

This section outlines a PCCC (PC³) Communications configuration between a DataMan reader and the PLC. This example uses the Allen-Bradley SLC5/05 and Rockwell 500 software.

Setting up the PLC for Ethernet Communication

1. From the RSLogix 500 software program, open the .RSS file, then open the Channel Configuration dialog (Project Folder > Controller Folder > Channel Configuration)

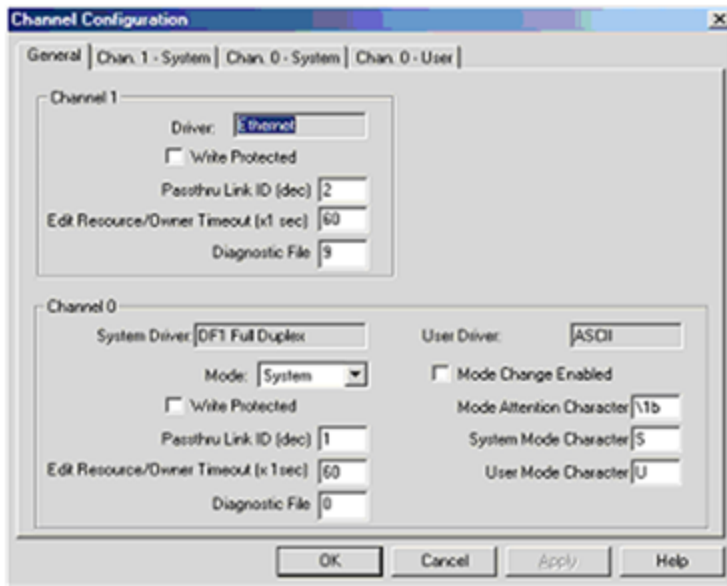

2. The Allen-Bradley SLC has 2 channels available for configuration: Channel 1 (Ethernet); and Channel 0 (DF1 Full Duplex - serial). Click on the **Chan. 1 - System** tab.
3. Configure Channel 1 (Ethernet) as necessary. Consult with a network administrator about settings.

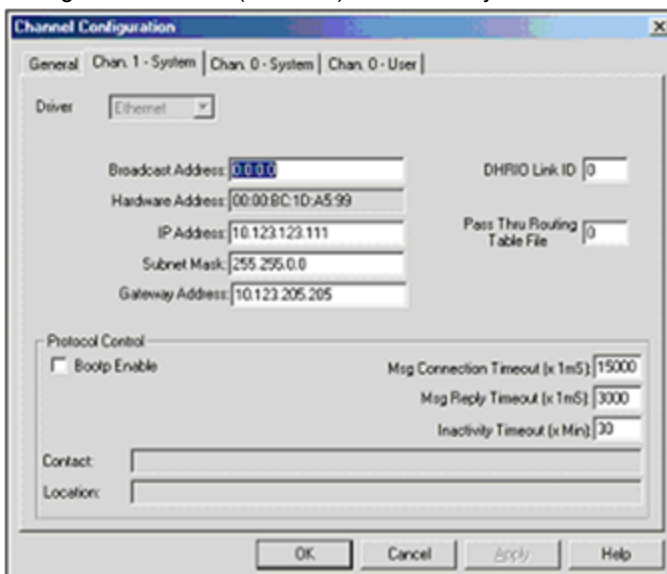

4. Configure the Timeouts as required.

Message Instruction (MSG)

Message instructions can now be constructed within the application. Refer to the RSLogix 500 documentation for expanded instructions for developing messages.

The following setup parameters can be configured within a Message (MSG) Instruction.



- **Type:** *Peer-To-Peer*. This cannot be modified.
- **Read/Write:** Select the function you want to perform on a DataMan reader. *Read* retrieves data from the DataMan; *Write* sends data to the DataMan.
- **Target Device:** Choose PLC5 to talk to a DataMan reader. This tells the SLC which communication protocol to use. The DataMan reader acts much like a ControlLogix controller (see **Rockwell document 13862**).
- **Local/Remote:** Choose *Local* to indicate that the DataMan reader is on the same network as the SLC; *Remote* tells the SLC that you will be communicating to a DataMan on another network. For remote communication, you have to direct the message through another device acting as a gateway to that secondary network. Typically, this could be an Allen-Bradley ControlLogix controller. (See the Rockwell documentation on how to address devices on other networks through a gateway.)
- **Control Block:** This is a temporary integer file that the MSG instruction uses to store data (that is, IP address, message type, and so on). This is typically not the user data to be sent.
- **Control Block Length:** This is automatically computed by the MSG instruction.
- **Setup Screen:** Selecting *Setup Screen* opens the *Message Instruction Setup* dialog.

The following setup parameters can be configured within an *MSG Instruction Setup* screen.

This Controller section:

- **Communication Command:** Make sure that it is the same command (READ/WRITE) as the command chosen on the first screen (as seen in MSG Instruction screen).

- **Data Table Address:** The location of the data file on the SLC where data will be written to (READ) or sent from (WRITE) (as seen in MSG Instruction screen). In this instance, 'N7:0', 'N' indicates the integer file, '7' indicates the file number 7, and '0' indicates the offset into that file (in this case, start at the 0th element).
- **Size in Elements:** The number of elements (or individual data) to read. In this example, two elements are being read.
- **Channel:** Depends on the configuration of the SLC. In the SLC, Channel 1 is the Ethernet port.

Target Device section:

- **Message Timeout:** Choose an appropriate length of time in which the DataMan reader can respond. If the DataMan does not respond within this length of time, the MSG instruction will error out. This parameter cannot be changed from this screen. The parameters entered in the Channel 1 setup dialog determine the Timeout Message.
- **Data Table Address:** The location on the DataMan reader where data will be read from or written to. In this instance, 'N7:1', 'N' indicates that the data is of type integer (16-bit); '7' is ignored by the DataMan (data is always being written to the Output Assembly, and read from the Input Assembly); and the '1' is the element offset from the start of the target buffer. For example: If the message were a READ, 'N7:2' would instruct to read the 3rd integer (the ':2' indicates the 3rd element, due to the SLC's 0-based index) from the Input Assembly (because a READ gets data from the DataMan's Input Assembly). If the message were a WRITE, 'N7:12' would indicate to write a (16-bit) integer value to the 13 integer location of the Output Assembly.

Note: The ST10:0 destination address is a special case used for sending DMCC commands to a DataMan reader. Any string sent to ST10:0 will be interpreted as a DMCC command.



- **Local/Remote:** Set to *Local* or *Remote*, depending on the application.
- **MultiHop:** This setting depends on the information previously entered. For successful In-Sight communication, make sure that it is YES at this time.

Sending DMCC Commands from an SLC 5/0

1. Configure the SLC5/05 as necessary.
2. Create a String Table that will hold your DMCC commands.



3. Add the required DMCC command strings to the Data File.

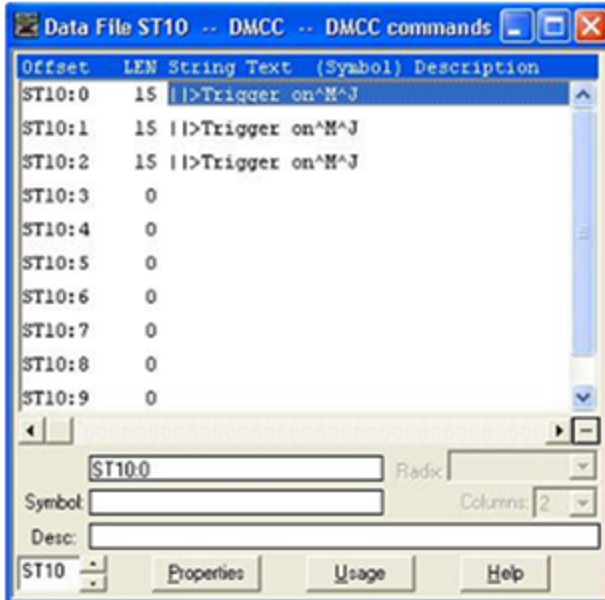

4. Add a new Message (MSG) instruction to your ladder logic and configure it as shown in the following example:

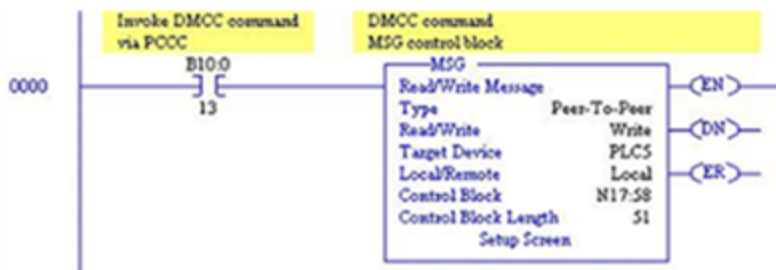

5. Enter the **MSG Setup Screen** and configure it as follows:

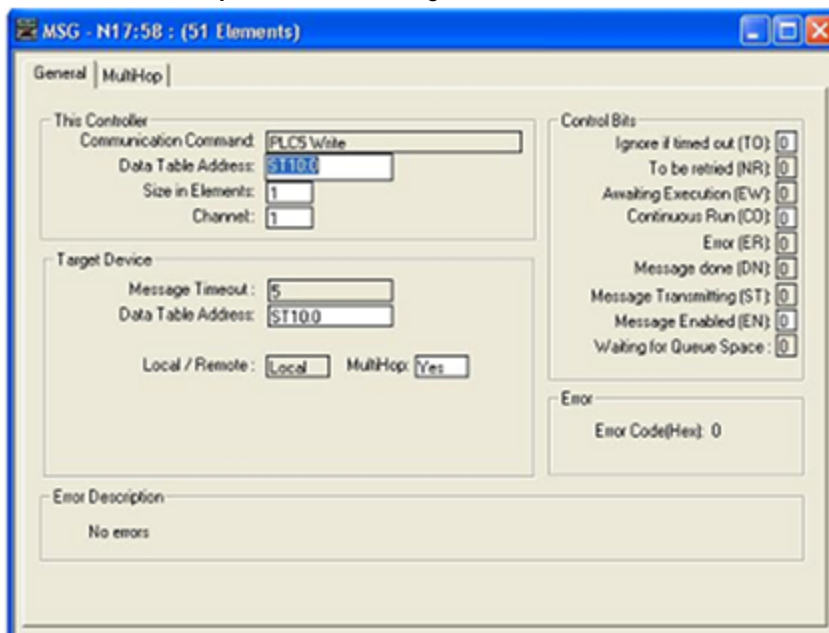

This Controller	Parameter	Description
Data Table Address	ST10:0	First element from the String Table (ST) created above.
Size in Elements	1	Always set to 1. PCCC MSG only allows 1 string (therefore 1 command) to be sent at a time.
Channel	1	Set this to the Ethernet channel of your controller.

Target Device	Parameter	Description
Message Timeout	(From channel configuration dialog)	
Data Table Address	ST10:0	This is the destination address. For DMCC commands, this will always be ST10:0.

- Click the **MultiHop** tab and configure it as required (that is, set IP address of DataMan).
- When everything is configured, close the MSG window.
- Save your ladder logic, download it to the controller, then go online and set the controller in RUN mode.
- Trigger the message to send it to the DataMan reader.

Message Instruction Results



The Enable (EN) bit of the message instruction will be set to 1 when the input to the instruction is set high. The Done (DN) bit will be set to 1 when DataMan has replied that the DMCC command was received and executed with success. If the Error bit (ER) is enabled (set to 1), it indicates a problem with the message instruction. If an error occurs, click the Setup Screen for the MSG instruction. The Error Code will be shown at the bottom of the window.

Using the Generic EtherNet/IP Profile

For devices without a specific Add-on Profile Rockwell provides a Generic EtherNet/IP profile. This profile allows you to create implicit messaging connections but lacks the automatic tag generation feature of a specific product Add-on Profile.

Establishing a Generic Implicit Messaging Connection

To set up an EtherNet/IP implicit messaging connection between a DataMan and a ControlLogix controller, add the DataMan reader to the ControlLogix I/O Configuration tree. This can be accomplished with the Rockwell provided generic profile.

To establish a generic implicit messaging connection with a ControlLogix PLC:

1. Open RSLogix5000 and load your project (or select “File->New...” to create a new one).
2. From the I/O Configuration node, select the Ethernet node under the project Ethernet Module, right-click the icon and select **New Module...** from the menu:

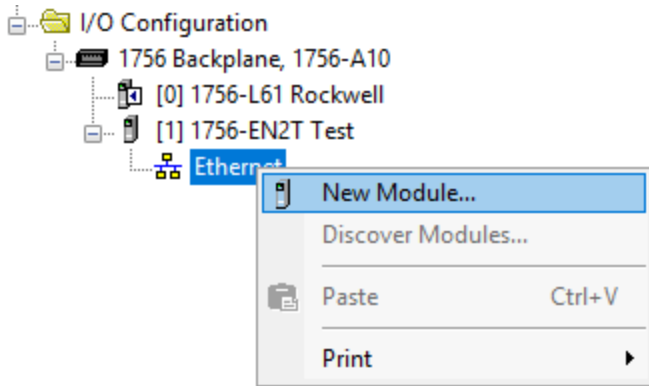

3. From the **Select Module Type** dialog, choose the Allen-Bradley Generic Ethernet Module.

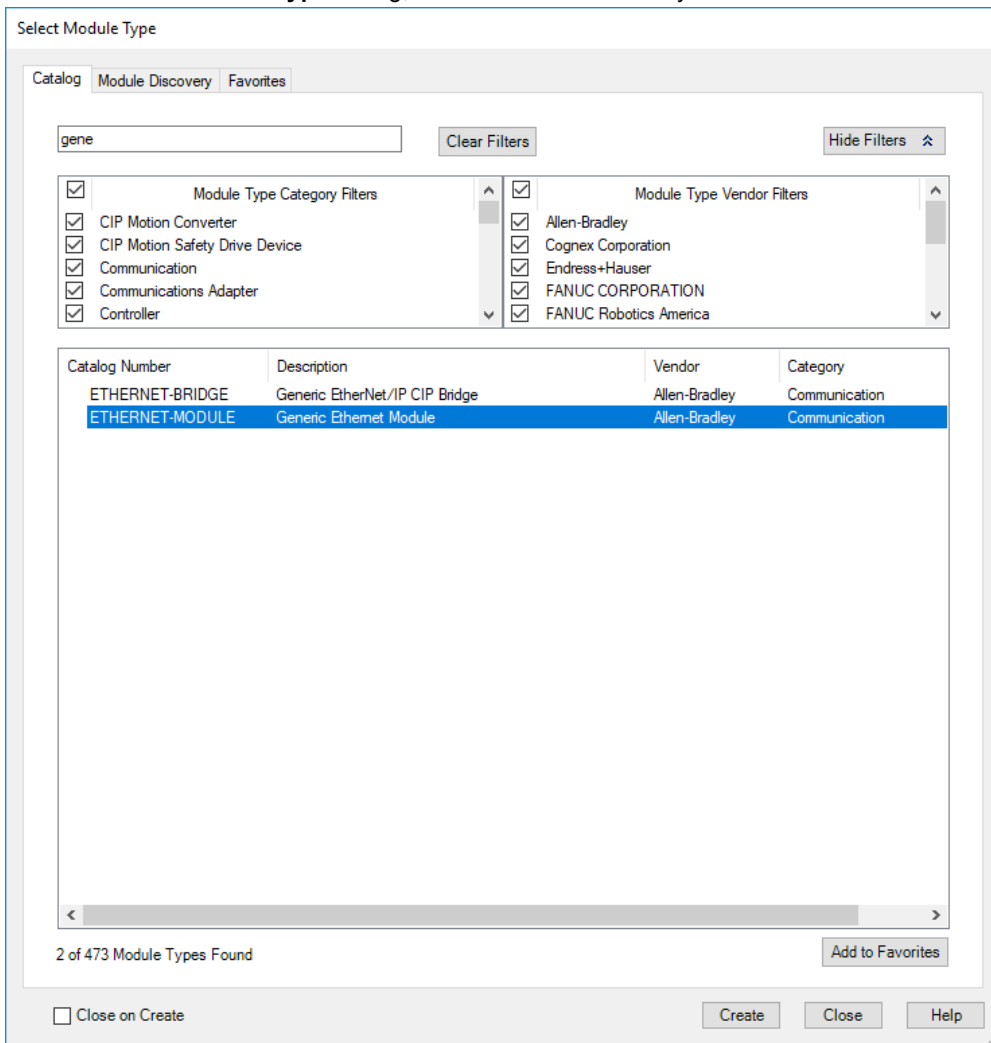

4. After selecting it, the configuration dialog for the Generic Ethernet Module is displayed. Configure the following:
- Give the module a name.
 - Enter your DataMan's IP address.
 - Set the Comm Format to "Data – INT". This tells the module to treat the data as an array of 16-bit integers.
 - Input Assembly: Set instance 11. Set the size to the amount of Input Assembly data you want the PLC to receive. Basic "Status" data requires 8 integers. The amount beyond that will be the actual decode result data. In the example below the size is set to 24 (8 for status + 16 for result data). This connection will receive the status info plus 32 bytes of result data.
 - Output Assembly: Set instance 21. Set the size to 4 integers. This size is sufficient to send all required "Control" data to the DataMan.
 - Configuration Assembly: Set instance 1. Set size to zero (not used).

New Module ✕

Type:	ETHERNET-MODULE Generic Ethernet Module		
Vendor:	Allen-Bradley		
Parent:	Test		
Name:	<input type="text" value="DM375"/>		
Description:	<input type="text"/>		
Comm Format:	Data - INT		
Address / Host Name			
<input checked="" type="radio"/> IP Address:	<input type="text" value=" . . ."/>		
<input type="radio"/> Host Name:	<input type="text"/>		

Connection Parameters			
	Assembly Instance:	Size:	
Input:	<input type="text" value="11"/>	<input type="text" value="24"/> (16-bit)	
Output:	<input type="text" value="21"/>	<input type="text" value="4"/> (16-bit)	
Configuration:	<input type="text" value="1"/>	<input type="text" value="0"/> (8-bit)	
Status Input:	<input type="text"/>	<input type="text"/>	
Status Output:	<input type="text"/>	<input type="text"/>	

Open Module Properties

5. Configure the connection rate. The rate at which data is transmitted/received is defined as the Requested Packet Interval (RPI). The RPI defines how frequently the data is transmitted/received over the connection. To optimize network performance, do not set this rate lower than absolutely required by a given application. You must not set it lower than half the median scan rate of the PLC ladder program. Setting it lower wastes bandwidth and does not improve processing performance.

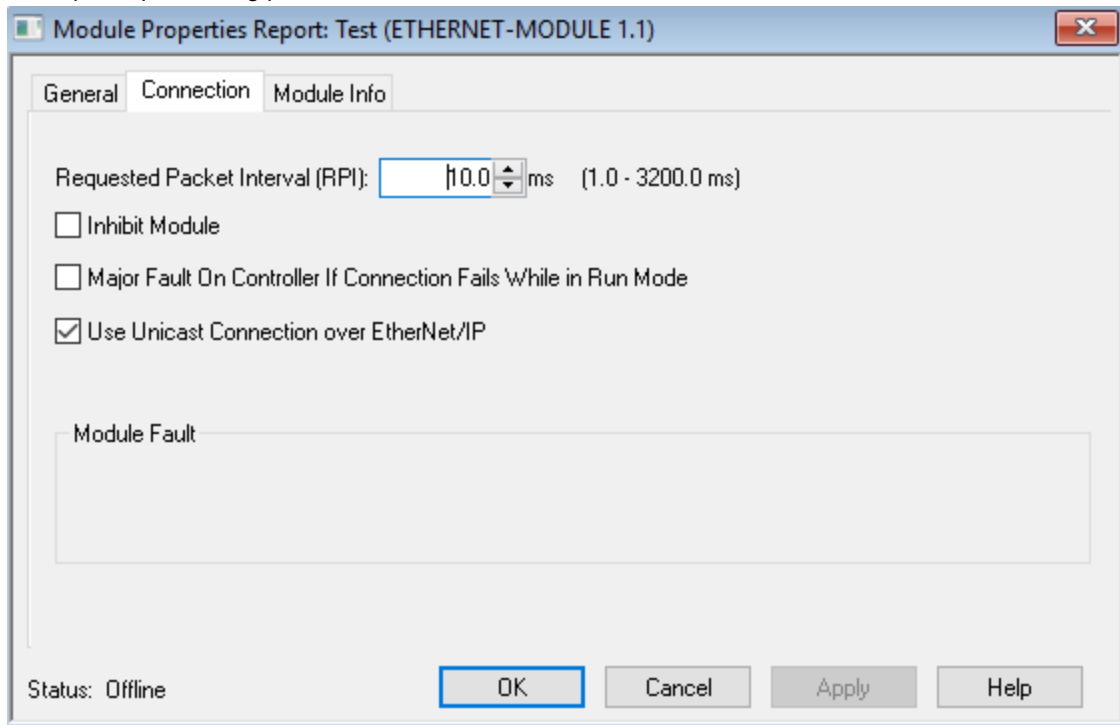

6. After adding the generic module to ControlLogix, the I/O tree appears as follows.

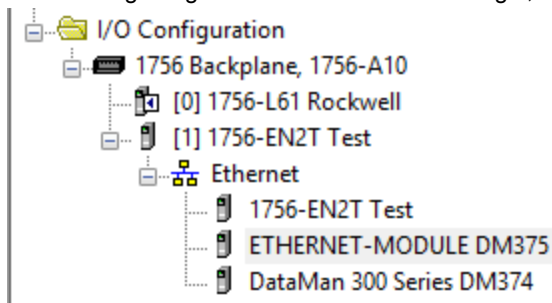

7. When the Generic Module is added to the I/O tree, RSLogix 5000 creates tags that map to the DataMan reader Input and Output Data (that is, the Input and Output Assembly Objects in the DataMan Reader). You can find these tags under the "Controller Tags" node of the project tree.

Note: The base name of these tags is the name you gave to the Generic Module that you added to the I/O Configuration earlier.

Name	Value	Style	Data Type	De
+ DM374:I	{...}		CC:DataMan_SINT32:I:0	
+ DM374:O	{...}		CC:DataMan_SINT32:O:0	
- DM375:I	{...}		AB:ETHERNET_MODULE_INT_48Bytes...	
- DM375:I.Data	{...}	Decimal	INT[24]	
+ DM375:I.Data[0]	0	Decimal	INT	
+ DM375:I.Data[1]	0	Decimal	INT	
+ DM375:I.Data[2]	0	Decimal	INT	
+ DM375:I.Data[3]	0	Decimal	INT	
+ DM375:I.Data[4]	0	Decimal	INT	
+ DM375:I.Data[5]	0	Decimal	INT	
+ DM375:I.Data[6]	0	Decimal	INT	
+ DM375:I.Data[7]	0	Decimal	INT	
+ DM375:I.Data[8]	0	Decimal	INT	
+ DM375:I.Data[9]	0	Decimal	INT	
+ DM375:I.Data[10]	0	Decimal	INT	
+ DM375:I.Data[11]	0	Decimal	INT	
+ DM375:I.Data[12]	0	Decimal	INT	
+ DM375:I.Data[13]	0	Decimal	INT	
+ DM375:I.Data[14]	0	Decimal	INT	
+ DM375:I.Data[15]	0	Decimal	INT	
+ DM375:I.Data[16]	0	Decimal	INT	
+ DM375:I.Data[17]	0	Decimal	INT	
+ DM375:I.Data[18]	0	Decimal	INT	
+ DM375:I.Data[19]	0	Decimal	INT	
+ DM375:I.Data[20]	0	Decimal	INT	
+ DM375:I.Data[21]	0	Decimal	INT	
+ DM375:I.Data[22]	0	Decimal	INT	
+ DM375:I.Data[23]	0	Decimal	INT	
- DM375:O	{...}		AB:ETHERNET_MODULE_INT_8Bytes...	
- DM375:O.Data	{...}	Decimal	INT[4]	
+ DM375:O.Data[0]	0	Decimal	INT	
+ DM375:O.Data[1]	0	Decimal	INT	
+ DM375:O.Data[2]	0	Decimal	INT	
+ DM375:O.Data[3]	0	Decimal	INT	
- DM375:C	{...}		AB:ETHERNET_MODULE:C:0	
+ DM375:C.Data	{...}	Hex	SINT[400]	

The tags are organized in three groups: Config “MyDM200:C”, Input “MyDM200:I”, and Output “MyDM200:O”. You can ignore the Config tags (not used). The Input tags represent all the data being received (from the DataMan). The Output tags represent all the data being sent (to the DataMan).

These tags are the data table representation of the DataMan Assembly Object contents. The PLC ladder is written to access these tag values. By monitoring or changing these tag values, the PLC ladder is actually monitoring and changing the DataMan Assembly Object contents.

Note: Based on the configured RPI, there is a time delay between the DataMan and the PLC tag values. Take this time delay into account when writing all PLC ladders.

Accessing Generic Implicit Messaging Connection Data

Unlike the DataMan Add-on Profile, the Generic Module profile does not automatically generate named tags representing the individual data items within an Assembly Object. Instead it simply generates an array of data according to the size of the connection you defined.

To access individual data items within an Assembly Object, manually select the correct tag offset and data subtype (if necessary) within the tag array that the Generic profile provided. This means that you have to manually reference the vendor documentation which defines the Assembly Objects.

Note: The start of the Input tags “MyDM200:I.Data[0]” maps directly to the start of the DataMan Input Assembly. Likewise, the start of the Output tags “MyDM200:O.Data[0]” maps directly to the start of the DataMan Output Assembly.

Examples

Input Assembly “TriggerReady”: Bit 0 of word 0 of the Input Assembly. From the Input tag array for the DataMan select bit 0 of word 0.

Controller Organizer Scope: Rockwell Show: All Tags

Name	Value	Style	Data Type	De
+ DM374:I	{...}		CC:DataMan_SINT32:I:0	
+ DM374:O	{...}		CC:DataMan_SINT32:O:0	
- DM375:I	{...}		AB:ETHERNET_MODULE_INT_48Bytes...	
- DM375:I.Data	{...}	Decimal	INT[24]	
+ DM375:I.Data[0]	0	Decimal	INT	
+ DM375:I.Data[1]	0	Decimal	INT	
+ DM375:I.Data[2]	0	Decimal	INT	
+ DM375:I.Data[3]	0	Decimal	INT	
+ DM375:I.Data[4]	0	Decimal	INT	
+ DM375:I.Data[5]	0	Decimal	INT	
+ DM375:I.Data[6]	0	Decimal	INT	
+ DM375:I.Data[7]	0	Decimal	INT	
+ DM375:I.Data[8]	0	Decimal	INT	
+ DM375:I.Data[9]	0	Decimal	INT	
+ DM375:I.Data[10]	0	Decimal	INT	
+ DM375:I.Data[11]	0	Decimal	INT	
+ DM375:I.Data[12]	0	Decimal	INT	
+ DM375:I.Data[13]	0	Decimal	INT	
+ DM375:I.Data[14]	0	Decimal	INT	
+ DM375:I.Data[15]	0	Decimal	INT	
+ DM375:I.Data[16]	0	Decimal	INT	
+ DM375:I.Data[17]	0	Decimal	INT	
+ DM375:I.Data[18]	0	Decimal	INT	
+ DM375:I.Data[19]	0	Decimal	INT	
+ DM375:I.Data[20]	0	Decimal	INT	
+ DM375:I.Data[21]	0	Decimal	INT	
+ DM375:I.Data[22]	0	Decimal	INT	
+ DM375:I.Data[23]	0	Decimal	INT	
- DM375:O	{...}		AB:ETHERNET_MODULE_INT_8Bytes...	
- DM375:O.Data	{...}	Decimal	INT[4]	
+ DM375:O.Data[0]	0	Decimal	INT	
+ DM375:O.Data[1]	0	Decimal	INT	
+ DM375:O.Data[2]	0	Decimal	INT	
+ DM375:O.Data[3]	0	Decimal	INT	
- DM375:C	{...}		AB:ETHERNET_MODULE:C:0	
+ DM375:C.Data	{...}	Hex	SINT[400]	

Input Assembly "ResultLength": Word 7 of the Input Assembly. From the Input tag array for the DataMan select word 7.

Controller Organizer Scope: Rockwell Show: All Tags

Name	Value	Style	Data Type
+ DM374:1	{...}		CC:DataMan_SINT32:1:0
+ DM374:0	{...}		CC:DataMan_SINT32:0:0
- DM375:1	{...}		AB:ETHERNET_MODULE_INT_48Bytes...
- DM375:1.Data	{...}	Decimal	INT[24]
- DM375:1.Data[0]	1	Decimal	INT
- DM375:1.Data[0].0	1	Decimal	BOOL
- DM375:1.Data[0].1	0	Decimal	BOOL
- DM375:1.Data[0].2	0	Decimal	BOOL
- DM375:1.Data[0].3	0	Decimal	BOOL
- DM375:1.Data[0].4	0	Decimal	BOOL
- DM375:1.Data[0].5	0	Decimal	BOOL
- DM375:1.Data[0].6	0	Decimal	BOOL
- DM375:1.Data[0].7	0	Decimal	BOOL
- DM375:1.Data[0].8	0	Decimal	BOOL
- DM375:1.Data[0].9	0	Decimal	BOOL
- DM375:1.Data[0].10	0	Decimal	BOOL
- DM375:1.Data[0].11	0	Decimal	BOOL
- DM375:1.Data[0].12	0	Decimal	BOOL
- DM375:1.Data[0].13	0	Decimal	BOOL
- DM375:1.Data[0].14	0	Decimal	BOOL
- DM375:1.Data[0].15	0	Decimal	BOOL
+ DM375:1.Data[1]	0	Decimal	INT
+ DM375:1.Data[2]	0	Decimal	INT
+ DM375:1.Data[3]	0	Decimal	INT
+ DM375:1.Data[4]	0	Decimal	INT
+ DM375:1.Data[5]	0	Decimal	INT
+ DM375:1.Data[6]	0	Decimal	INT
+ DM375:1.Data[7]	0	Decimal	INT
+ DM375:1.Data[8]	0	Decimal	INT
+ DM375:1.Data[9]	0	Decimal	INT
+ DM375:1.Data[10]	0	Decimal	INT
+ DM375:1.Data[11]	0	Decimal	INT
+ DM375:1.Data[12]	0	Decimal	INT
+ DM375:1.Data[13]	0	Decimal	INT

Output Assembly "Trigger": Bit 1 of word 0 of the OutputAssembly. From the Output tag array for the DataMan select bit 1 of word 0.

PROFINET

PROFINET is an application-level protocol used in industrial automation applications. This protocol uses standard Ethernet hardware and software to exchange I/O data, alarms, and diagnostics.

DataMan supports PROFINET I/O. This is one of the two “views” contained in the PROFINET communication standard. PROFINET I/O performs cyclic data transfers to exchange data with Programmable Logic Controllers (PLCs) over Ethernet. The second “view” in the standard, PROFINET Component Based Automation (CBA), is not supported.

By default, the DataMan has the PROFINET protocol disabled. The protocol can be enabled via DMCC, scanning a parameter code or in the DataMan Setup Tool.

Note: If you have a wireless DataMan reader, see section [Industrial Protocols for the Wireless DataMan on page 116](#)

DMCC

The following commands can be used to enable/disable PROFINET. The commands can be issued via RS-232 or Telnet connection.

Note: Use a third party Telnet client such as PuTTY to communicate with your DataMan reader.

Enable:

```
||>SET PROFINET.ENABLED ON
||>CONFIG.SAVE
||>REBOOT
```

Disable:

```
||>SET PROFINET.ENABLED OFF
||>CONFIG.SAVE
||>REBOOT
```

Reader Configuration Code

Scanning the following reader configuration codes enables/disables PROFINET for your corded reader.

Note: You must reboot the device for the change to take effect.

Enable:



Disable:



Scanning the following reader configuration codes enables/disables PROFINET for your DataMan 8000 base station.

Note: You must reboot the device for the change to take effect.



Setup Tool

In the Setup Tool's **Communications** application step's **Ethernet** tab, check **PROFINET** to enable this industrial protocol.

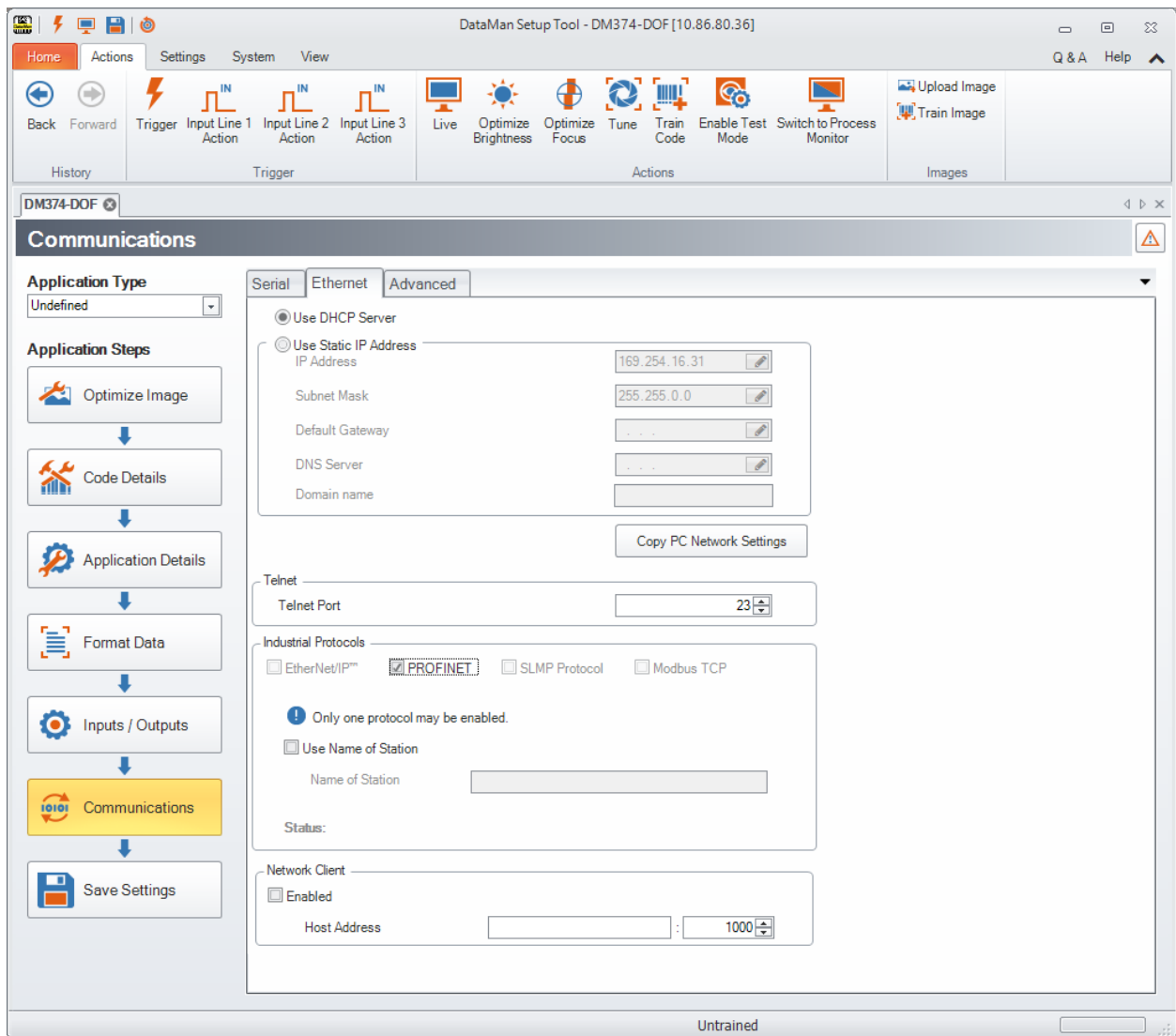

Make sure to save the new selection by clicking the **Save Settings** button in the upper toolbar before disconnecting from the reader.

Note: The new settings take effect only after the reader is rebooted.

Getting Started

Preparing to use PROFINET involves the following main steps:

- Make sure that you have either the SIMATIC Step 7 programming software or TIA Portal installed.
- Set up the Siemens Software tool so that it recognizes your DataMan device.
- Install the Generic Station Description (GSD) file.

Note: Expanding the process image can have a performance impact on the PLC scan cycle time. If your scan time is critical, use the minimal acceptable module sizes and manually remap them down lower in the process image.

Perform the following steps to set up PROFINET using SIMATIC or TIA Portal:

1. Verify that SIMATIC is on your machine.
2. From the Windows **Start** menu, go to Cognex and select the folder that contains the PROFINET tools.

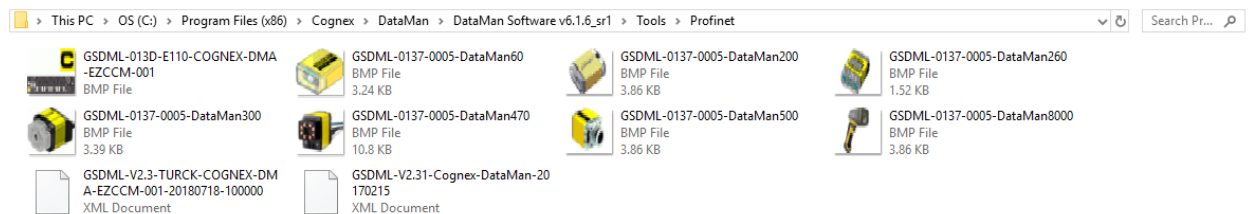
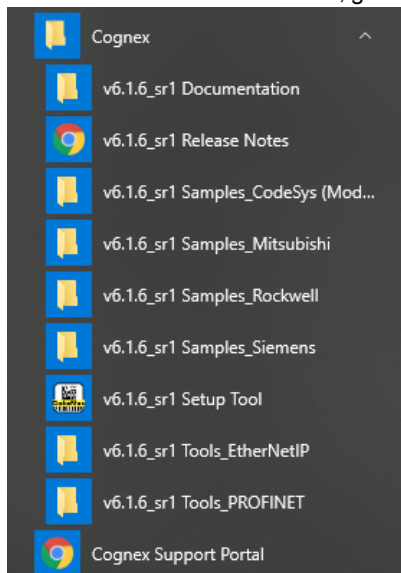

3. Check if the DataMan's firmware is up-to-date by clicking, in the Setup Tool, **View** and then **System Info**.

4. Make sure that in the Setup Tool, **PROFINET** is enabled.

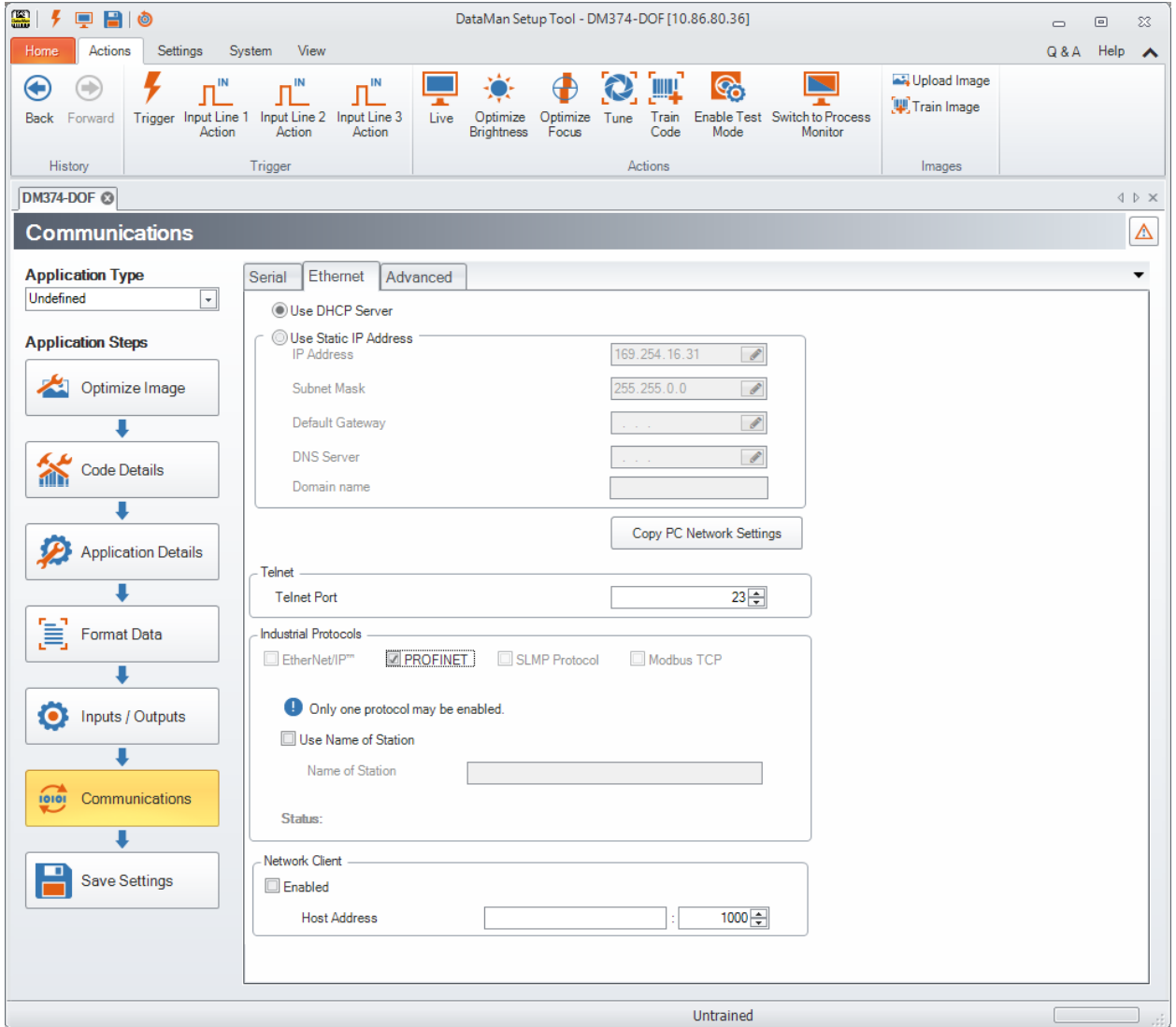

5. Download the *TIA Portal Integration Guide* from <https://support.cognex.com/en/downloads/detail/in-sight/3687/1033>.

The screenshot shows the Cognex support website interface. At the top, there is a yellow header with the Cognex logo and contact information. Below this is a dark navigation bar with links for Products, Industries, Applications, Support, How to Buy, Resources, and Company. A secondary navigation bar includes 'MyCognex Log In | Create Account' and a search icon. The main content area features a large banner with the word 'SUPPORT' and technical drawings. Below the banner, a breadcrumb trail reads 'Home > Home > Support > In-Sight > Documentation > PLC Communication Notes'. The main heading is 'TIA PORTAL INTEGRATION GUIDE FOR IN-SIGHT AND DATAMAN'. A descriptive paragraph states: 'An integration guide for adding either an In-Sight or DataMan to a Siemens PLC using the TIA Portal software. Also included is a spreadsheet for generating all of the tags for the various control and status modules'. Technical details listed include: File Type: zip, File Size: 2.0MB, Version: 1.0, and Release Date: 8/8/2018. There are two buttons: a blue 'DOWNLOAD' button and a white 'Email a Link' button. On the left side, there is a vertical navigation menu with the following items: In-Sight (selected), VisionPro, DataMan, Checker, Cognex Designer, 3D Vision Systems, Mobile Solutions, DVT, VisionView, CVL, OmniView, AlignPlus, In-Sight Profiler, Deep Learning, ISVC200, In-Sight Emulator Key, DataMan Feature Key, Product Catalog, and Knowledgebase.

6. Open the *PROFINET Tag Generator* file that is included in the *TIA Portal Integration Guide*.

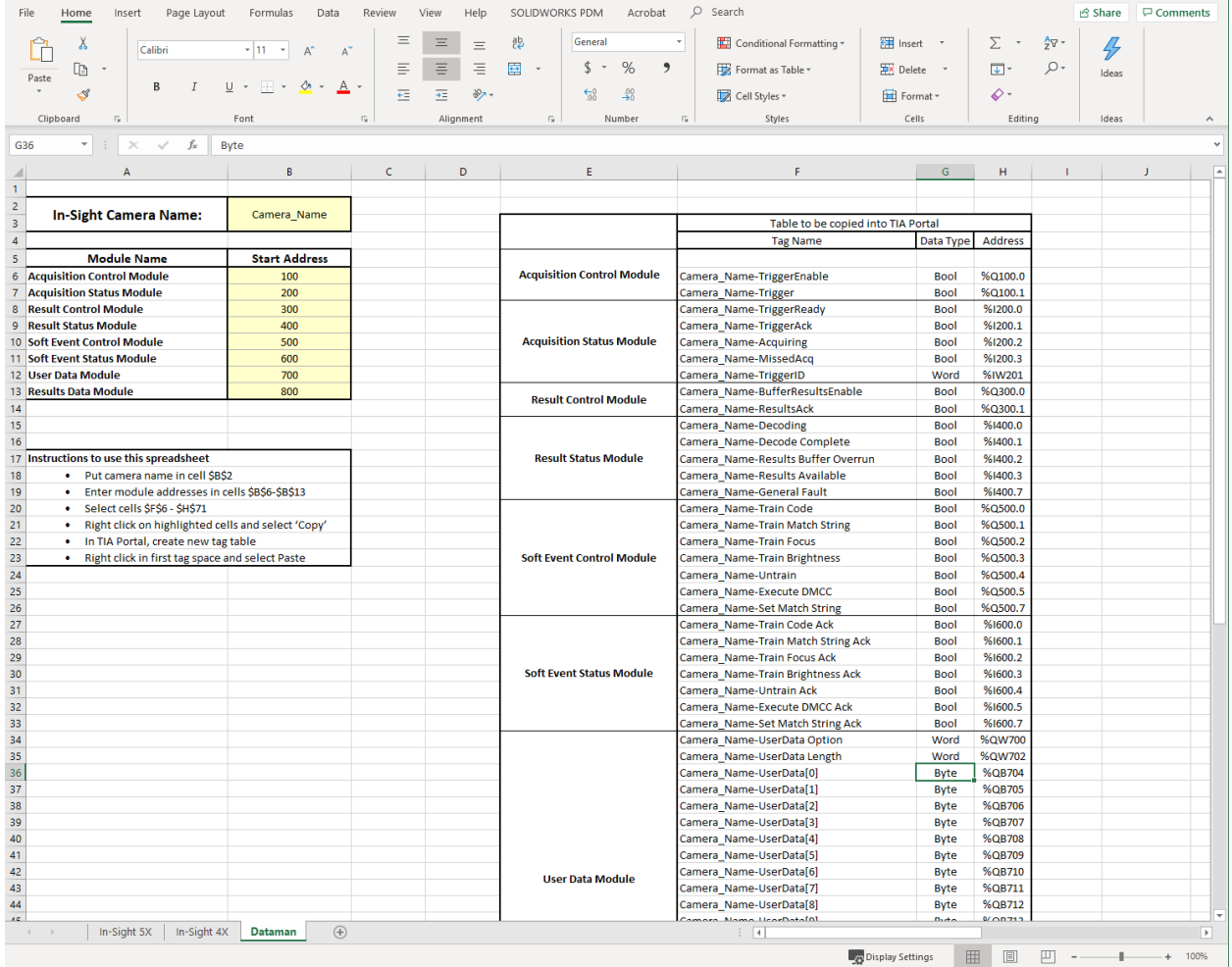

7. From the Windows **Start** menu, launch the SIMATIC Manager or TIA Portal.

Object Model

Modules

The PROFINET implementation on DataMan consists of seven I/O modules:

1. Acquisition Control Module
2. Acquisition Status Module
3. Results Control Module
4. Results Status Module
5. SoftEvent Control Module
6. User Data Module
7. Result Data Module

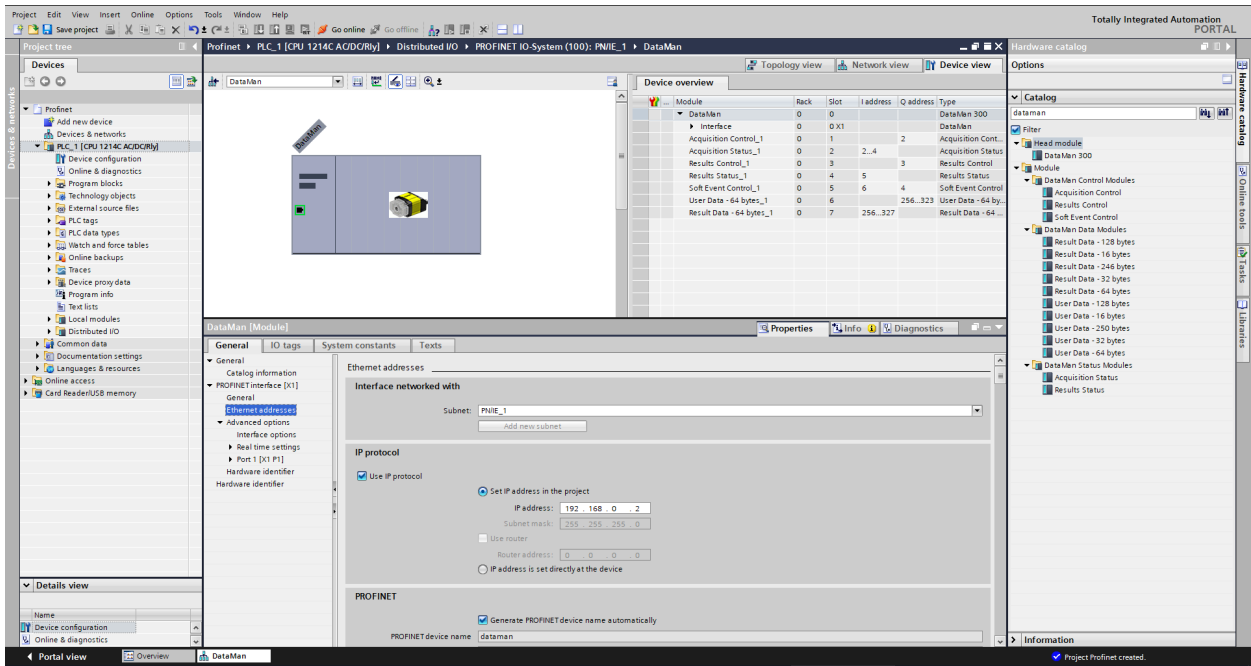

Acquisition Control Module

Controls image acquisition. This module consists of data sent from the PLC to the DataMan device.

Slot number: 1

Total Module size: 1 byte

Bit	Name	Description
0	Trigger Enable	Setting this bit enables triggering via PROFINET. Clearing this bit disables triggering.
1	Trigger	Setting this bit triggers an acquisition when the following conditions are met: <ul style="list-style-type: none"> • Trigger Enable is set • No acquisition is currently in progress • The device is ready to trigger
2-7	Reserved	Reserved for future use

Acquisition Status Module

Indicates the current acquisition status. This module consists of data sent from the DataMan device to the PLC.

Slot number: 2

Total Module size: 3 bytes

Bit	Name	Description
0	Trigger Ready	Indicates when the device is ready to accept a new trigger. Bit is True when “Trigger Enable” is set and the device is ready to accept a new trigger.
1	Trigger Ack	Indicates that the DataMan has received a new Trigger. This bit remains True as long as the “Trigger” bit remains True (that is, it is interlocked with the Trigger bit).
2	Reserved	Reserved for future use.
3	Missed Ack	Indicates that the DataMan was unable to successfully trigger an acquisition. Bit is cleared when the next successful acquisition occurs.
4-7	Reserved	Reserved for future use.

8-23	Trigger ID	ID value of the next trigger to be issued (16-bit integer). Used to match issued triggers with corresponding result data received later. This same value is returned in ResultID of the result data.
------	------------	--

Note: The Missed Ack bit in the Acquisition Status Register will only be set if an acquisition triggered from the Acquisition Control Module could not get executed.

Results Control Module

Controls the processing of result data. This module consists of data sent from the PLC to the DataMan device.

Slot number: 3

Total Module size: 1 byte

Bit	Name	Description
0	Results Buffer Enable	Enables queuing of "Result Data". If enabled, the current result data will remain until acknowledged (even if new results arrive). New results are queued. The next set of results are pulled from the queue (made available in the Result Data module) each time the current results are acknowledged. The DataMan will respond to the acknowledge by clearing the "Results Available" bit. Once the "Results Ack" bit is cleared the next set of read results will be posted and "Results Available" will be set True. If results buffering is not enabled newly received read results will simply overwrite the content of the Result Data module.
1	Results Ack	Bit is used to acknowledge that the PLC has successfully read the latest result data. When set True the "Result Available" bit will be cleared. If result buffering is enabled, the next set of result data will be pulled from the queue and "Result Available" will again be set True.
2-7	Reserved	Reserved for future use.

Results Status Module

Indicates the acquisition and result status. This module consists of data sent from the DataMan device to the PLC.

Slot number: 4

Total Module size: 1 byte

Bit	Name	Description
0	Decoding	Indicates that the DataMan is decoding an acquired image.
1	Decode Complete	Bit is toggled on the completion of a decode operation when the new results are made available (0 -> 1 or 1 -> 0).
2	Result Buffer Overrun	Indicates that the DataMan has discarded a set of read results because the results queue is full. Cleared when the next set of results are successfully queued.
3	Results Available	Indicates that a new set of read results are available, that is, the contents of the Result Data module are valid. Cleared when the results are acknowledged.
4-6	Reserved	Reserved for future use
7	General Fault	Indicates that a fault has occurred, that is, SoftEvent "Set Match String" or "Execute DMCC" error has occurred.

SoftEvent Control Module

Used to initiate a SoftEvent and receive acknowledgment of completion. Note that this is a bi-directional I/O module. Module data sent from the PLC initiates the SoftEvent. Module data sent by the DataMan device acknowledges completion.

Slot number: 5

Total Module size: 1 byte (input) and 1 byte (output)

Data written from the PLC to DataMan:

Bit	Name	Description
0	Train Code	Bit transition from 0 -> 1 causes the train code operation to be invoked.
1	Train Match String	Bit transition from 0 -> 1 causes the train match string operation to be invoked.
2	Train Focus	Bit transition from 0 -> 1 causes the train focus operation to be invoked.
3	Train Brightness	Bit transition from 0 -> 1 causes the train brightness operation to be invoked.
4	Untrain	Bit transition from 0 -> 1 causes the untrain operation to be invoked.
5	Reserved	Reserved for future use
6	Execute DMCC	Bit transition from 0 -> 1 causes the DMCC operation to be invoked. Note that a valid DMCC command string must first be placed in "User Data" before invoking this event.
7	Set Match String	Bit transition from 0 -> 1 causes the set match string operation to be invoked. Note that match string data must first be placed in "User Data" before invoking this event.

Data written from the DataMan to PLC:

Bit	Name	Description
0	Train Code Ack	Indicates that the "Train Code" operation is complete
1	Train Match String Ack	Indicates that the "Train Match String" operation is complete
2	Train Focus Ack	Indicates that the "Train Focus" operation is complete
3	Train Brightness Ack	Indicates that the "Train Brightness" operation is complete
4	Untrain Ack	Indicates that the "Untrain" operation is complete
5	Reserved	Reserved for future use
6	Execute DMCC Ack	Indicates that the "Execute DMCC" operation is complete
7	Set Match String Ack	Indicates that the "Set Match String" operation is complete

User Data Module

Data sent from a PLC to a DataMan to support acquisition, decode and other special operations. Currently this module is only used to support the "Execute DMCC" and "Set Match String" SoftEvents.

Note: There are 5 versions of the User Data module. Only one instance can be configured for use in a given application. The "User Data Option" and "User Data Length" fields are the same for each module. The "User Data" field varies in size based on the selected module. Choose the module which is large enough to exchange the amount of data your application requires.

Slot number: 6

Total Module size:

4 + 16 (16 bytes of User Data)

4 + 32 (32 bytes of User Data)

4 + 64 (64 bytes of User Data)

4 + 128 (128 bytes of User Data)

4 + 250 (250 bytes of User Data)

Byte	Name	Description
------	------	-------------

0-1	User Data Option	Currently only used by "Set Match String" SoftEvent. Specifies which code target to assign the string (16-bit Integer). 0, assign string to all targets 1, assign string to 2D codes 2, assign string to QR codes 3, assign string to 1D / stacked / postal codes
2-3	User Data Length	Number of bytes of valid data actually contained in the "User Data" field (16-bit Integer).
4...	User Data	Data sent from the PLC to the DataMan to support acquisition, decoding, and other special operations (array of bytes).

Result Data Module

Read result data sent from a DataMan to a PLC.

Look into the Result Data Module for non-PROFINET related data if there is an acquisition problem on the reader. The "Result Code" part contains information about trigger overruns or buffer overflows that have occurred on the reader.

Note: There are 5 versions of the Result Data module. Only a single instance can be configured for use in a given application. The "Result ID", "Result Code", "Result Extended" and "Result Length" fields are the same for each module. The "Result Data" field varies in size based on the selected module. Choose the module which is large enough to exchange the amount of result data your application requires.

Slot number: 7

Total Module size:

8 + 16 (16 bytes of Result Data)

8 + 32 (32 bytes of Result Data)

8 + 64 (64 bytes of Result Data)

8 + 128 (128 bytes of Result Data)

8 + 246 (246 bytes of Result Data)

Byte	Name	Description
0-1	Result ID	The value of the "Trigger ID" when the trigger that generated these results was issued. Used to match up triggers with corresponding result data (16-bit Integer).
2-3	Result Code	Indicates the success or failure of the read that produced these results (16-bit Integer). Bit 0,1=read, 0=no read Bit 1,1=validated, 0=not validated (or validation not in use) Bit 2,1=verified, 0=not verified (or verification not in use) Bit 3,1=acquisition trigger overrun Bit 4,1=acquisition buffer overflow Bits 5-15 reserved
4-5	Result Extended	Currently unused (16-bit Integer).
6-7	Result Length	Actual number of bytes of read data contained in the "Result Data" field (16-bit Integer).
8...	Result Data	Decoded read result data (array of bytes)

Operation

SoftEvents

SoftEvents act as "virtual" inputs. When the value of a SoftEvent changes from 0 -> 1 the action associated with the event will be executed. When the action completes the corresponding SoftEventAck bit will change from 0 -> 1 to signal completion. The acknowledge bit will change back to 0 when the corresponding SoftEvent bit is set back to 0.

The “ExecuteDMCC” and “SetMatchString” SoftEvent actions require user supplied data. This data must be written to the UserData and UserDataLength area of the UserData Module prior to invoking the SoftEvent. Only one SoftEvent can be invoked at a time because both of these SoftEvents depend on the UserData.

General Fault Indicator

When a communication related fault occurs the “GeneralFault” bit will change from 0 -> 1. Currently the only fault conditions supported are SoftEvent operations. If a SoftEvent operation fails, the fault bit will be set. The fault bit will remain set until the next SoftEvent operation or until triggering is disabled and again re-enabled.

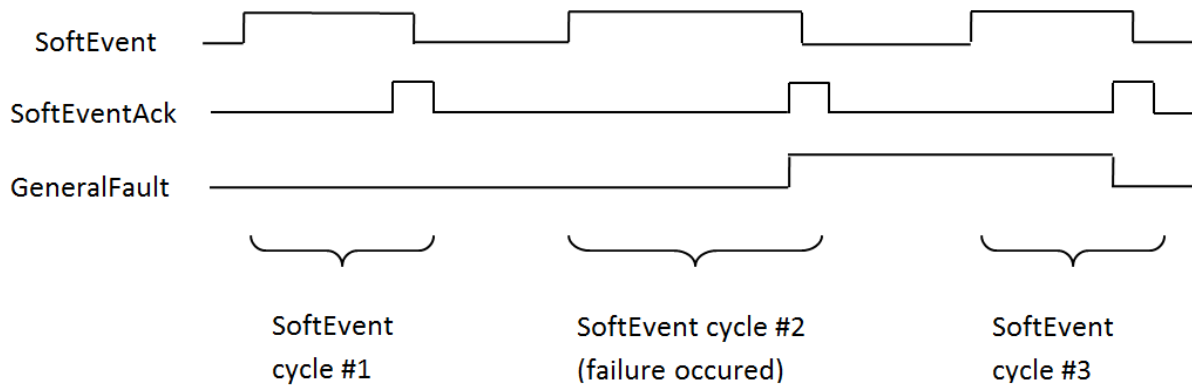

Acquisition Sequence

DataMan can be triggered to acquire images by several methods. It can be done explicitly by manipulating the Trigger bit of the Acquisition Control Module, it can be triggered by external hard wired input, and it can be triggered via DMCC. This section describes manipulating the Acquisition Control Module bits.

On startup the “Trigger Enable” bit will be False. It must be set to True to enable triggering. When the device is ready to accept triggers, the “Trigger Ready” bit will be set to True.

While the Trigger Ready bit is True, each time the reader detects the “Trigger” bit change from 0 to 1, it initiates an image acquisition. Make sure that the client (PLC) holds the bit in the new state until that same state value is seen back in the Trigger Ack bit. This is a necessary handshake to guarantee that the reader detects the change.

During an acquisition, the Trigger Ready bit will be cleared and the Acquiring bit will be set to True. When the acquisition is completed, the Acquiring bit will be cleared. The Trigger Ready bit is again set to True once the device is ready to begin a new image acquisition.

If results buffering is enabled, the device will allow overlapped acquisition and decoding operations. Trigger Ready will be set high after acquisition is complete but while decoding is still in process. This can be used to achieve faster overall trigger rates. If result buffering is not enabled, the Trigger Ready bit will remain low until both the acquisition and decode operations are complete.

To force a reset of the trigger mechanism, set the Trigger Enable bit to False, until the Trigger Ready bit is 0. Then, Trigger Enable can be set to True to re-enable acquisition.

As a special case, an acquisition can be cancelled by clearing the Trigger signal before the read operation is complete. This allows cancelling reads in Presentation and Manual mode if no code is in the field of view. To ensure that a read is not unintentionally cancelled, it is advised that the PLC hold the Trigger signal True until both TriggerAck and ResultsAvailable are True or DecodeComplete toggles state.

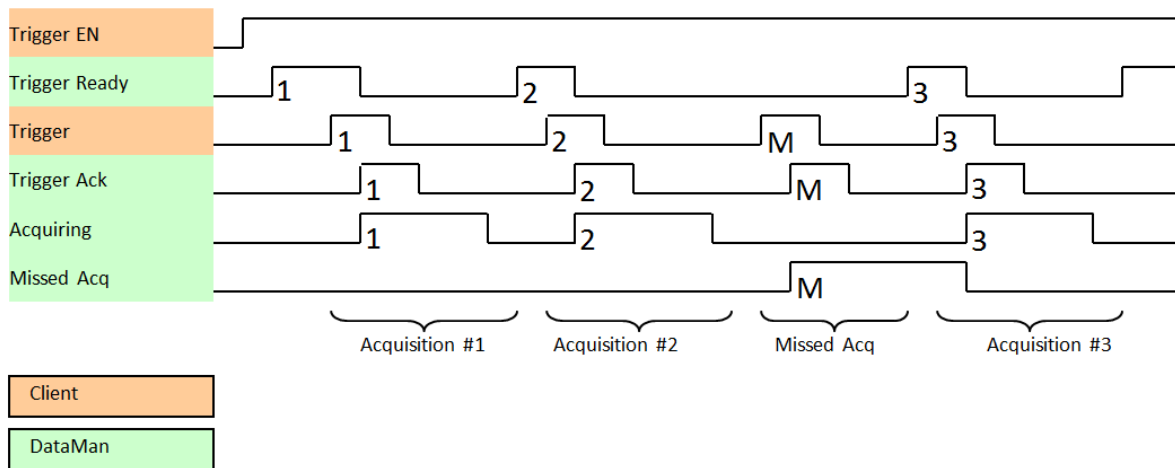

Decode / Result Sequence

After an image is acquired, it is decoded. While being decoded, the “Decoding” bit of the Result Status Module is set. When decode is complete, the Decoding bit is cleared and the “Decode Complete” bit is toggled.

The “Results Buffer Enable” bit determines how the reader handles decode results. If the Results Buffer Enable bit is set to False, then the decode results are immediately placed into the Results Module and Results Available is set to True.

If the Results Buffer Enable bit is set to True, the new results are queued. The earlier decode results remain in the Results Module until the client acknowledges them by setting the “Results Ack” bit to True. After the Results Available bit is cleared, make sure that the client sets the Results Ack bit back to False to allow the next queued results to be placed in to the Results Module. This is a necessary handshake to ensure the results are received by the DataMan client (PLC).

Behavior of DecodeStatusRegister

Bit	Bit Name	Results if Buffering Disabled	Results if Buffering Enabled
0	Decoding	Set when decoding an image.	Set when decoding an image.
1	Decode Complete	Toggled on completion of an image decode.	Toggled on completion of an image decode.
2	Results Buffer Overflow	Remains set to zero.	Set when decode results could not be queued because the client failed to acknowledge a previous result. Cleared when the decode result is successfully queued.
3	Results Available	Set when new results are placed in the Results Module. Stays set until the results are acknowledged by setting Results Ack to true.	Set when new results are placed in the Results Module. Stays set until the results are acknowledged by setting Results Ack to true.

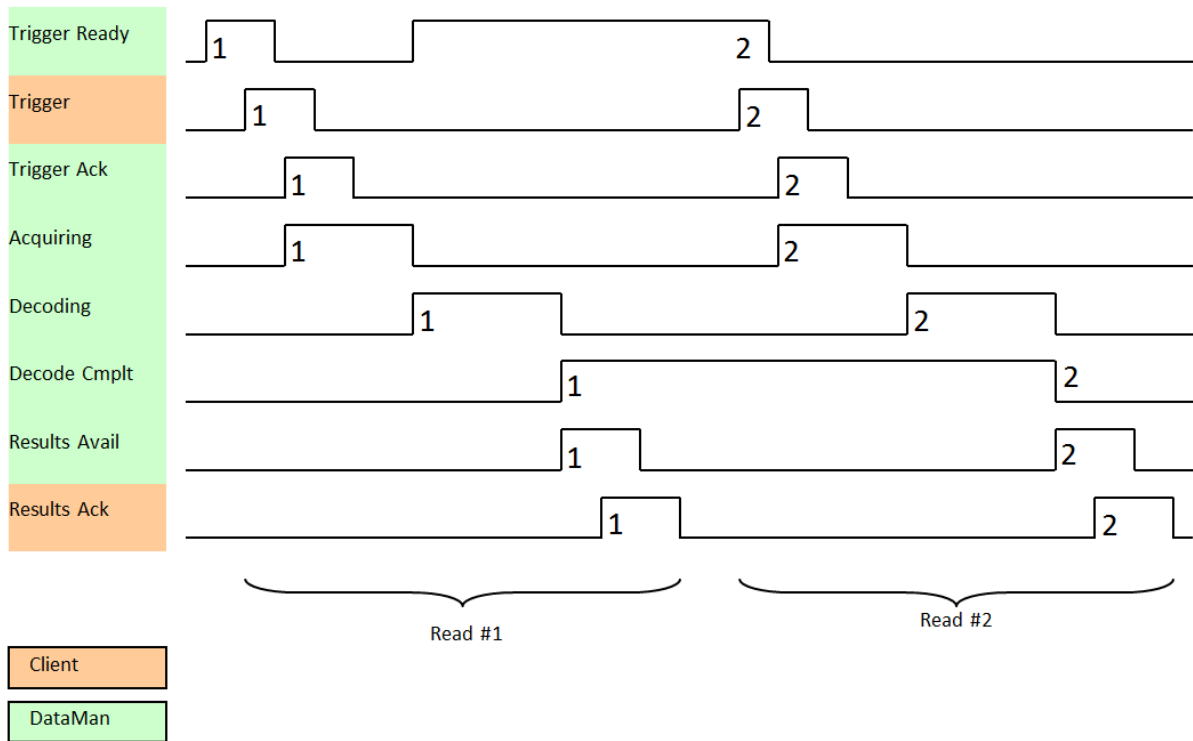

Results Buffering

There is an option to enable a queue for decode results. If enabled, this allows a finite number of decode result data to queue up until the client (PLC) has time to read them. This is useful to smooth out data flow if the client (PLC) slows down for short periods of time or if there are surges of read activity.

If result buffering is enabled, the device will allow overlapped acquisition and decode operations. Depending on the application this can be used to achieve faster over all trigger rates. For more information, see the Acquisition Sequence description.

In general, if reads are occurring faster than results can be sent out, the primary difference between buffering or not buffering determines which results get discarded. If buffering is not enabled the most recent results are kept and the earlier result (which was not read by the PLC fast enough) is lost. The more recent result overwrites the earlier result. If buffering is enabled and the queue becomes full, the most recent results are discarded until space becomes available in the results queue.

Note: If the queue has overflowed and then buffering is disabled, there will be a greater than 1 difference between the TriggerID and ResultID values. This difference represents the number of reads that occurred but could not be queued because the queue was full (number of lost reads equals TriggerID - ResultID - 1). After the next read, the ResultID value will return to the typical operating value of TriggerID - 1.

SIMATIC Examples

This section gives some examples of using the DataMan with a Siemens S7-300 PLC assuming that you are familiar with the S7-300 and the SIMATIC programming software.

1. If you already have a project, click **Cancel** to skip past the New Project wizard. Otherwise, let the wizard guide you through creating a new project.

- In the opened project, double-click the Hardware icon to open the **HW Config** dialog. From the main menu, select **Options -> Install GSD File...**

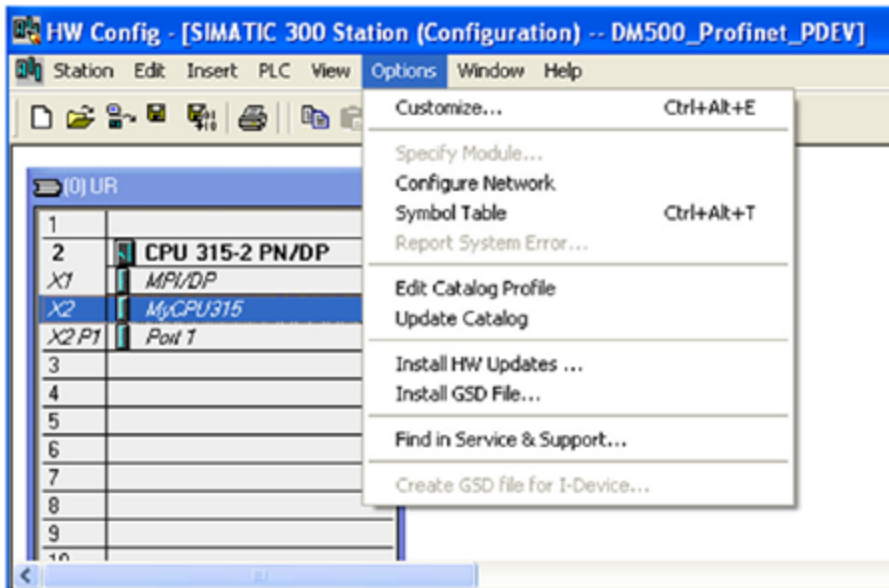

- Browse to the installation folder of the GSD file (or the folder where you saved the GSD file if you downloaded it from the web).

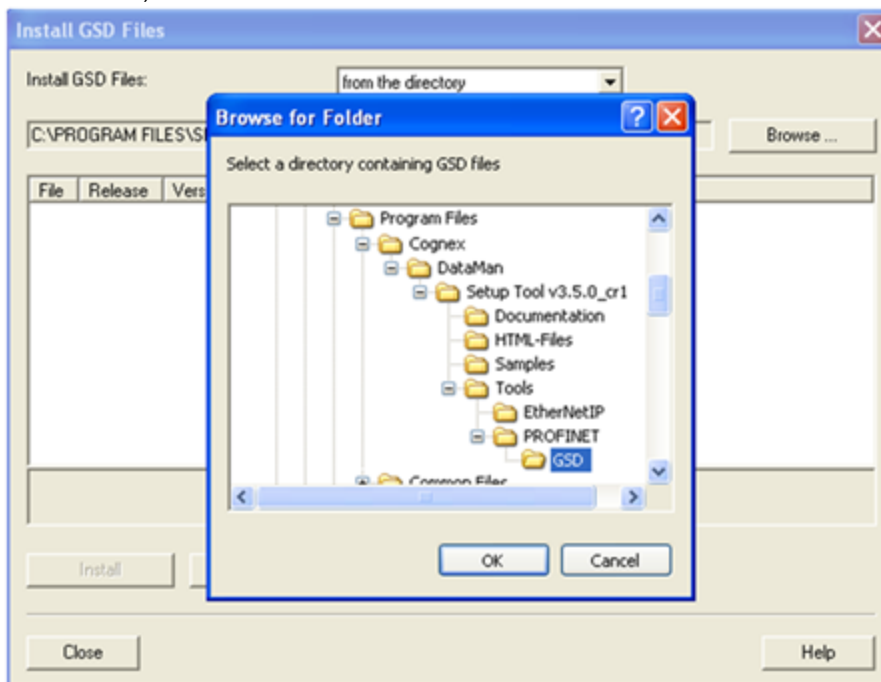

- Select the GSD file you wish to install and follow the displayed instructions to complete the installation.

Note: If there is more than one GSD file in the list, and you are unsure which to install, choose the one with the most recent date.

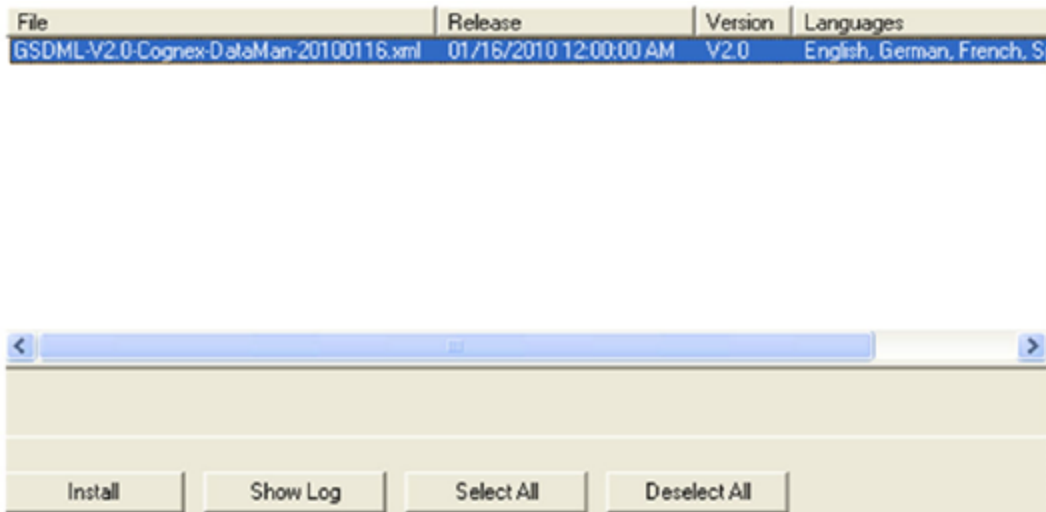

5. Add your DataMan device to your project. This makes the DataMan available in the Hardware Catalog. Launch the SIMATIC Hardware Config tool.
6. In the main menu, select View -> Catalog.
7. The catalog is displayed. Expand the **PROFINET IO** tree to the **Cognex ID Readers** node.
8. Press and hold the left mouse button to drag the DataMan reader and drop it on the PROFINET IO network symbol in the left pane.

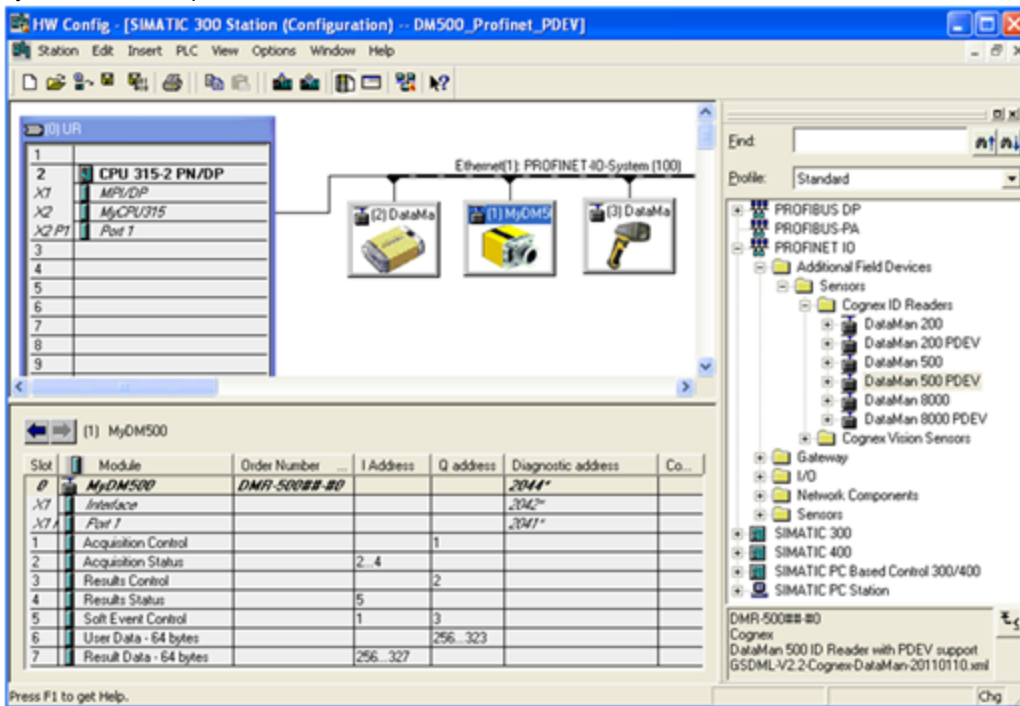

The HW Config tool automatically maps the DataMan I/O modules into the memory space.

Note: By default, the 64 byte User Data and 64 byte Result Data Modules are inserted. There are multiple sizes available for both of these modules. To optimize performance, use the module size that most closely matches the actual data requirements of your application. You can change the module by deleting the one in the table and inserting the appropriate sized module from the catalog.

9. Right-click the DataMan icon and select **Object Properties....**
10. Give the reader a name. This must match the name of your actual DataMan reader. The name must be unique and follow DNS naming conventions. For details, see the SIMATIC Software help.
11. If your DataMan reader is configured to use its own static IP, uncheck **Assign IP address via IO controller**. As an alternative, if you wish the PLC to assign an IP address, select the Ethernet button and configure the appropriate address.

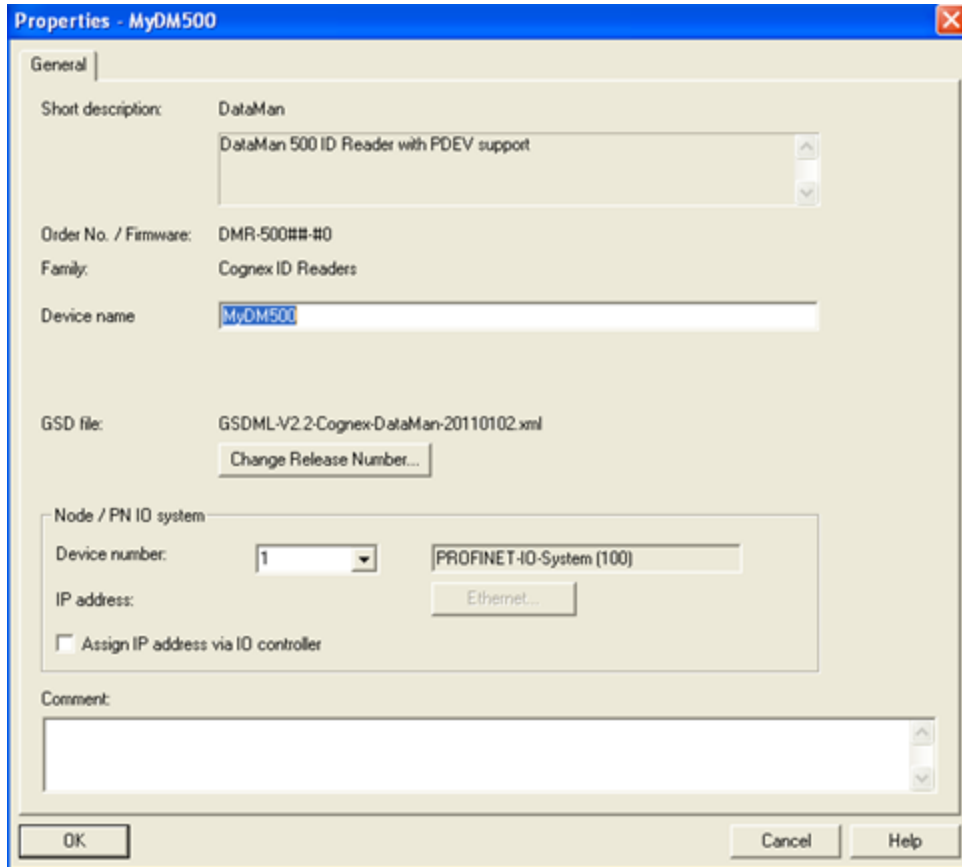

12. In the **IO Cycle** tab, select the appropriate cyclic update rate for your application.

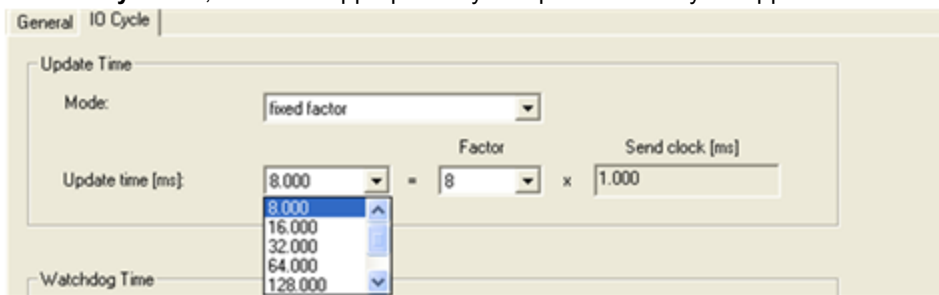

13. By default, the SIMATIC software maps the User Data and Result Data Modules to offset 256. This is outside of the default process image area size of 128. That is, data in these modules are inaccessible by some SFCs such as BLKMOV. As a solution, either remap the modules to lower offsets within the process image area or expand the process image area to include these modules.

If you choose to expand the process image area, make the size large enough for the module size plus the default 256 offset.

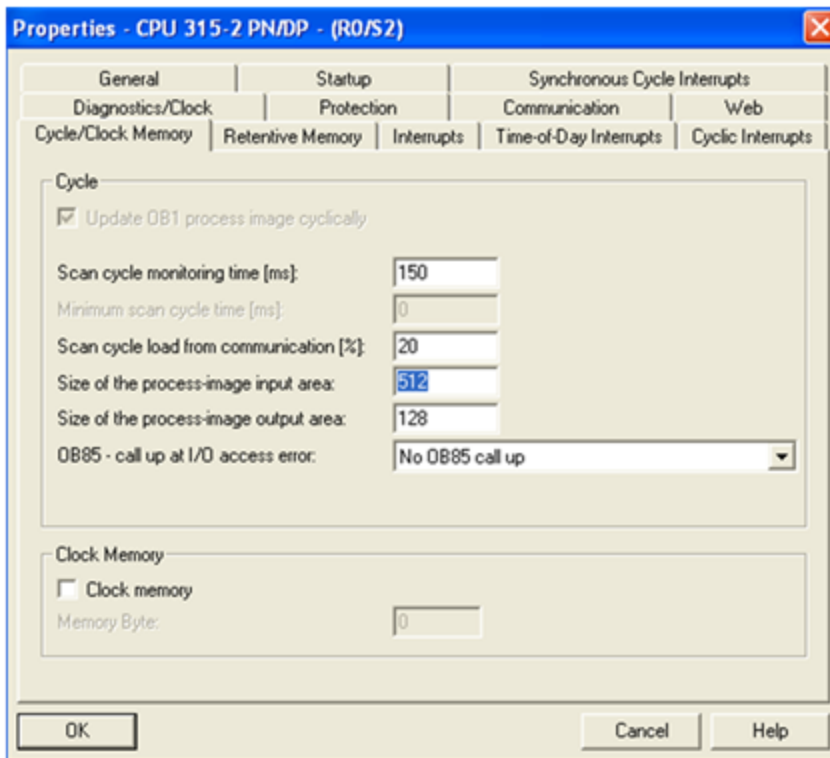

Note: Expanding the process image can have a performance impact on the PLC scan cycle time. If your scan time is critical, use the minimal acceptable module sizes and manually remap them down lower in the process image.

Symbol Table

It is recommended that you define symbols for the DataMan I/O module elements to make the code much easier to read and reduce mistakes. This sample table shows symbols defined for a typical instance of a DataMan reader. It is possible that DataMan I/O modules are at different addresses in your project. Make sure to adjust your symbol definitions based on the specific offsets of the I/O modules.

Status	Symbol	Address	Data type	Comment
1	Reader_TriggerEnable	Q 1.0	BOOL	
2	Reader_Trigger	Q 1.1	BOOL	
3	Reader_TriggerReady	I 2.0	BOOL	
4	Reader_TriggerAck	I 2.1	BOOL	
5	Reader_Acquiring	I 2.2	BOOL	
6	Reader_MissedAck	I 2.3	BOOL	
7	Reader_TriggerID	MV 3	WORD	
8	Reader_BufferEnable	Q 2.0	BOOL	
9	Reader_ResultsAck	Q 2.1	BOOL	
10	Reader_Decoding	I 5.0	BOOL	
11	Reader_DecodeComplete	I 5.1	BOOL	
12	Reader_ResultsOverrun	I 5.2	BOOL	
13	Reader_ResultsAvailable	I 5.3	BOOL	
14	Reader_GeneralFault	I 5.7	BOOL	
15	Reader_TrainCode	Q 3.0	BOOL	
16	Reader_TrainMatchString	Q 3.1	BOOL	
17	Reader_TrainFocus	Q 3.2	BOOL	
18	Reader_TrainBrightness	Q 3.3	BOOL	
19	Reader_UnTrain	Q 3.4	BOOL	
20	Reader_ExecuteDmcc	Q 3.6	BOOL	
21	Reader_SetMatchString	Q 3.7	BOOL	
22	Reader_TrainCodeAck	I 1.0	BOOL	
23	Reader_TrainMatchStrAck	I 1.1	BOOL	
24	Reader_TrainFocusAck	I 1.2	BOOL	
25	Reader_TrainBrightAck	I 1.3	BOOL	
26	Reader_UnTrainAck	I 1.4	BOOL	
27	Reader_ExecuteDmccAck	I 1.6	BOOL	
28	Reader_SetMatchStringAck	I 1.7	BOOL	
29	Reader_UserDataOption	QW 256	WORD	
30	Reader_UserDataLength	QW 258	WORD	
31	Reader_ResultID	MV 256	WORD	
32	Reader_ResultCode	MV 258	WORD	
33	Reader_ResultExtended	MV 260	WORD	
34	Reader_Resultlength	MV 262	WORD	

Trigger and Get Results

Run the sample program “DM200_SampleRead” for the complete example program.

Note: This sample can be used with any PROFINET enabled DataMan reader.

Perform the following steps to install the program:

1. Start the SIMATIC Manager software.
2. Close any open applications.
3. From the main menu, select **File -> Retrieve...**
4. Browse to find the sample file on your PC.

File Explorer path: This PC > OS (C:) > Program Files (x86) > Cognex > DataMan > DataMan Software v6.1.6 > Samples > Siemens

Name	Date modified	Type	Size
Cognex-Dataman.zip	5/24/2019 2:28 PM	Compressed (zipp...	2,567 KB
COGNEX-DMA-EZCCM_Profinet.zip	3/25/2019 11:32 AM	Compressed (zipp...	2,815 KB
Dm200_SampleRead.zip	3/19/2019 9:16 AM	Compressed (zipp...	475 KB
Dm200_SoftEvents.zip	3/19/2019 9:16 AM	Compressed (zipp...	493 KB
Dm300_SampleRead.zip	3/19/2019 9:16 AM	Compressed (zipp...	802 KB
Dm300_SoftEvents.zip	3/19/2019 9:16 AM	Compressed (zipp...	801 KB
Dm500_SampleRead.zip	3/19/2019 9:16 AM	Compressed (zipp...	770 KB
Dm500_SoftEvents.zip	3/19/2019 9:16 AM	Compressed (zipp...	787 KB
Dm8000_SampleRead.zip	3/19/2019 9:16 AM	Compressed (zipp...	760 KB
Dm8000_SoftEvents.zip	3/19/2019 9:16 AM	Compressed (zipp...	773 KB

5. Save the project on your PC.

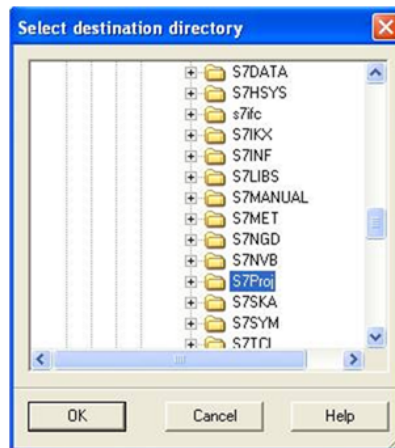

6. The Siemens software extracts the sample archive and makes it available.

Reduced to the basics, the process of reading and retrieving results consists of the following:

1. Define an area in your application to save read results. There are many options regarding how and where result data can be stored. In this example, a Data Block (DB) is defined containing the fields of the Result Data module that are relevant for our application.

Address	Name	Type	Initial value	Comment
0.0		STRUCT		
+0.0	ID	INT	0	ID of this read result
+2.0	Flags	INT	0	Flags indicating success or failure
+4.0	Length	INT	0	Number of data bytes in the array Value[]
+6.0	Value	ARRAY[1..63]		Code value read
*1.0		CHAR		
=70.0		END_STRUCT		

2. Enable the reader.



3. Set the trigger signal and set coil to indicate a read is pending.

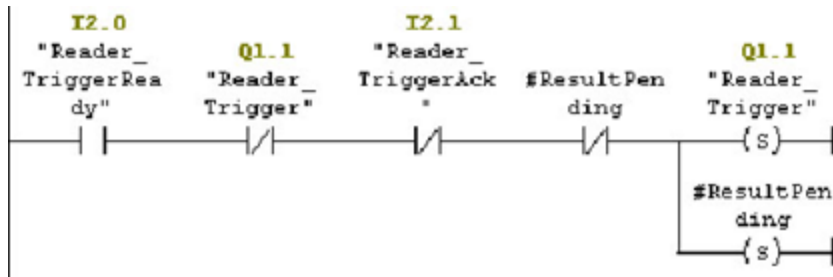

4. As soon as the trigger signal is acknowledged, clear the trigger signal.

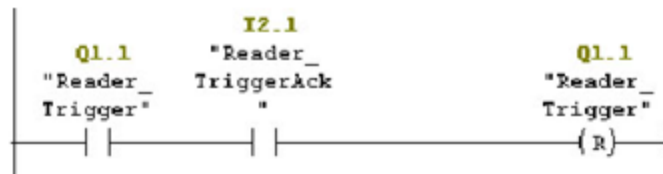

5. As soon as the results are available, save a copy of the result data and set the results acknowledge signal.

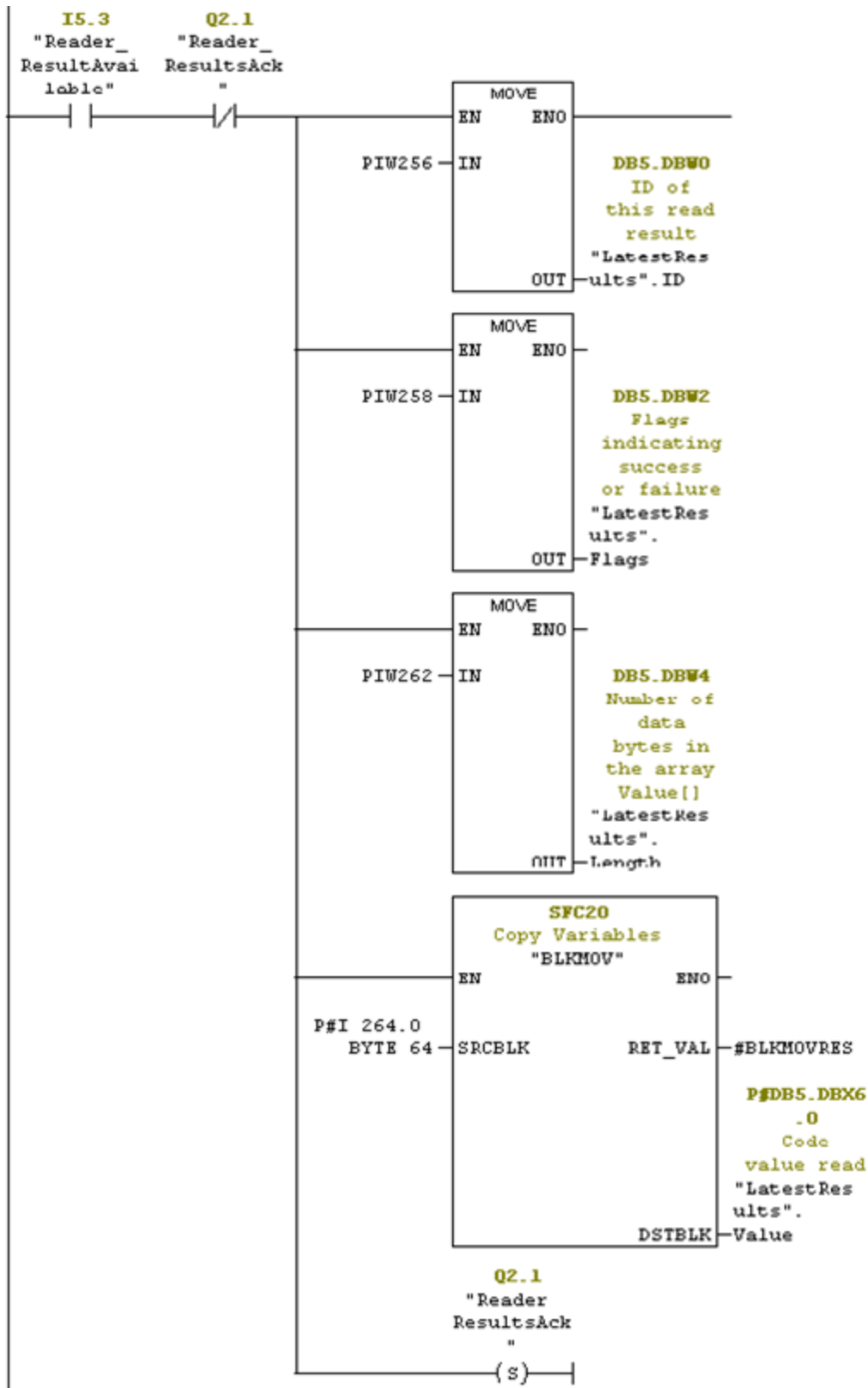

- When the reader sees the result acknowledge signal, clear result acknowledge, clear the read pending coil, and signal that the read process is complete.

Note: The reader clears “Results Available” as soon as it sees the PLC’s “Results Ack” signal.

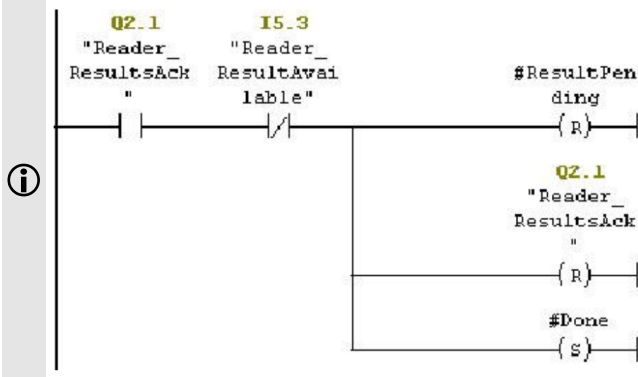

Using SoftEvents

Run the sample program “DM200_SoftEvents” for the complete example program.

Note: This sample can be used with any PROFINET enabled DataMan reader.

Perform the following steps to install the program:

1. Start the SIMATIC Manager software.
2. Close any open applications.
3. From the main menu, select **File -> Retrieve...**
4. Browse to find the sample file on your PC.

This PC > OS (C:) > Program Files (x86) > Cognex > DataMan > DataMan Software v6.1.6 > Samples > Siemens				
Name	Date modified	Type	Size	
Cognex-Dataman.zip	5/24/2019 2:28 PM	Compressed (zipp...	2,567 KB	
COGNEX-DMA-EZCCM_Profinet.zip	3/25/2019 11:32 AM	Compressed (zipp...	2,815 KB	
Dm200_SampleRead.zip	3/19/2019 9:16 AM	Compressed (zipp...	475 KB	
Dm200_SoftEvents.zip	3/19/2019 9:16 AM	Compressed (zipp...	493 KB	
Dm300_SampleRead.zip	3/19/2019 9:16 AM	Compressed (zipp...	802 KB	
Dm300_SoftEvents.zip	3/19/2019 9:16 AM	Compressed (zipp...	801 KB	
Dm500_SampleRead.zip	3/19/2019 9:16 AM	Compressed (zipp...	770 KB	
Dm500_SoftEvents.zip	3/19/2019 9:16 AM	Compressed (zipp...	787 KB	
Dm8000_SampleRead.zip	3/19/2019 9:16 AM	Compressed (zipp...	760 KB	
Dm8000_SoftEvents.zip	3/19/2019 9:16 AM	Compressed (zipp...	773 KB	

5. Select Dm200_SoftEvents.zip from the Siemens folder.
6. Select a destination folder to save the project on your PC.

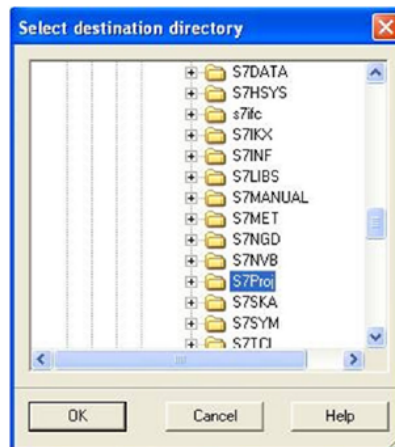

7. The Siemens software extracts the sample archive and makes it available.

SoftEvents are a means of invoking an activity by manipulating a single control bit. The activity for each bit is predefined (for more details, see section [SoftEvents](#)). With the exception of "Execute DMCC" and "Set Match String" all SoftEvents may be invoked in the same way. "Execute DMCC" and "Set Match String" require the added step of loading the User Data module with application data before invoking the event.

Reduced to the basics, the process of invoking a SoftEvent consists of the following:

FC3 : Train Focus

Initiate the "Train Focus" operation and monitor it to completion.

Network 1 : Title:

Issue "Train Focus" signal.

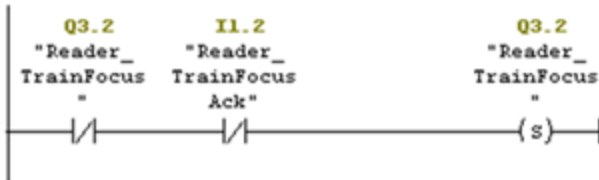

Network 2 : Title:

Release "Train Focus" signal as soon as it is acknowledged by the reader.

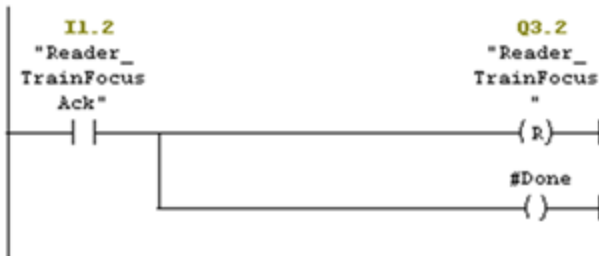

Network 3 : Title:

Set the return FC state.
Note, this will only return TRUE after the acknowledge has been received from the reader. Otherwise it will return FALSE.



Executing DMCC Commands

Refer to sample program "DM200_SoftEvents" for the complete example program. For information on how to install it, see section [Using SoftEvents](#).

Note: This sample can be used with any PROFINET enabled DataMan reader.

"Execute DMCC" is a SoftEvent which requires the added step of loading the User Data module with the desired DMCC command string before invoking the event. Note that the SoftEvent mechanism does not provide a means of returning DMCC response data other than a failure indication. This mechanism cannot be used for DMCC ">GET..." commands.

The process of executing a DMCC command is the same for all other SoftEvents as in the example above except the step of invoking the SoftEvent also includes copying the command string to the User Data Module. In this example the command string is in a Data Block. This example can be expanded to utilize a Data Block with an array of command strings that the copy function can reference by an index value. It allows the user to pre-define all DMCC commands that are required by the application and invoke them by index.

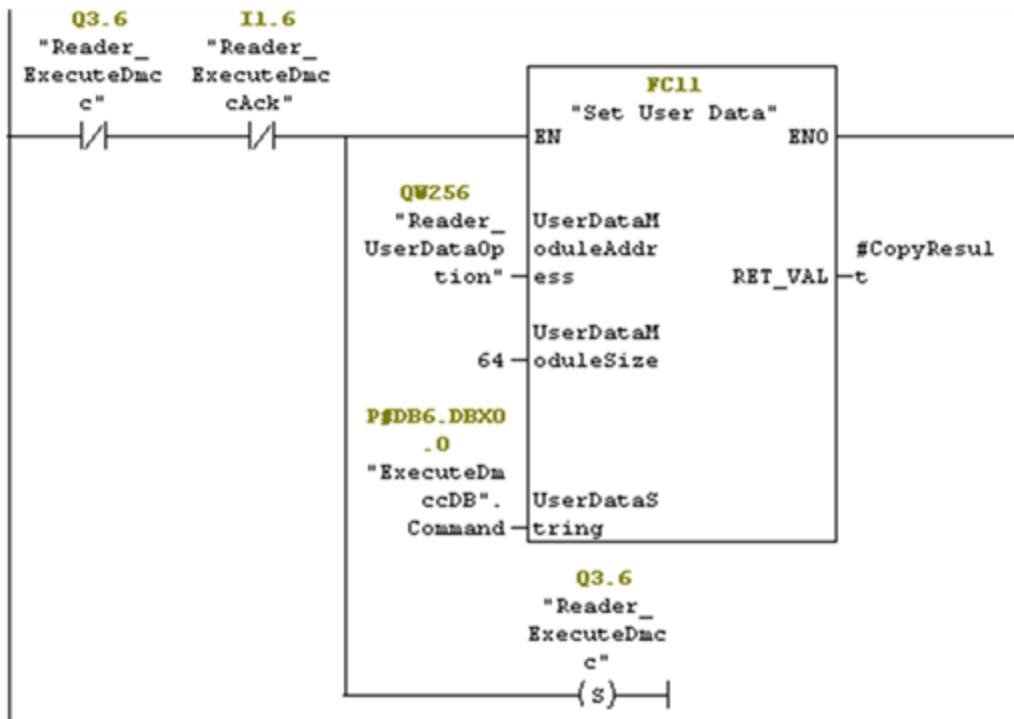

The function "Set User Data" (FC11) copies the provided string to the User Data module. Refer to the example program for the actual STL code.

TIA Portal Examples

This section gives some examples of using the DataMan with a Siemens S7-1200 PLC, assuming that you are familiar with the S7-1200 and TIA Portal.

1. In TIA Portal, either create a new project, or open an existing one.
2. In **Project View**, click **Options** and click **Manage general station description files (GSD)**.

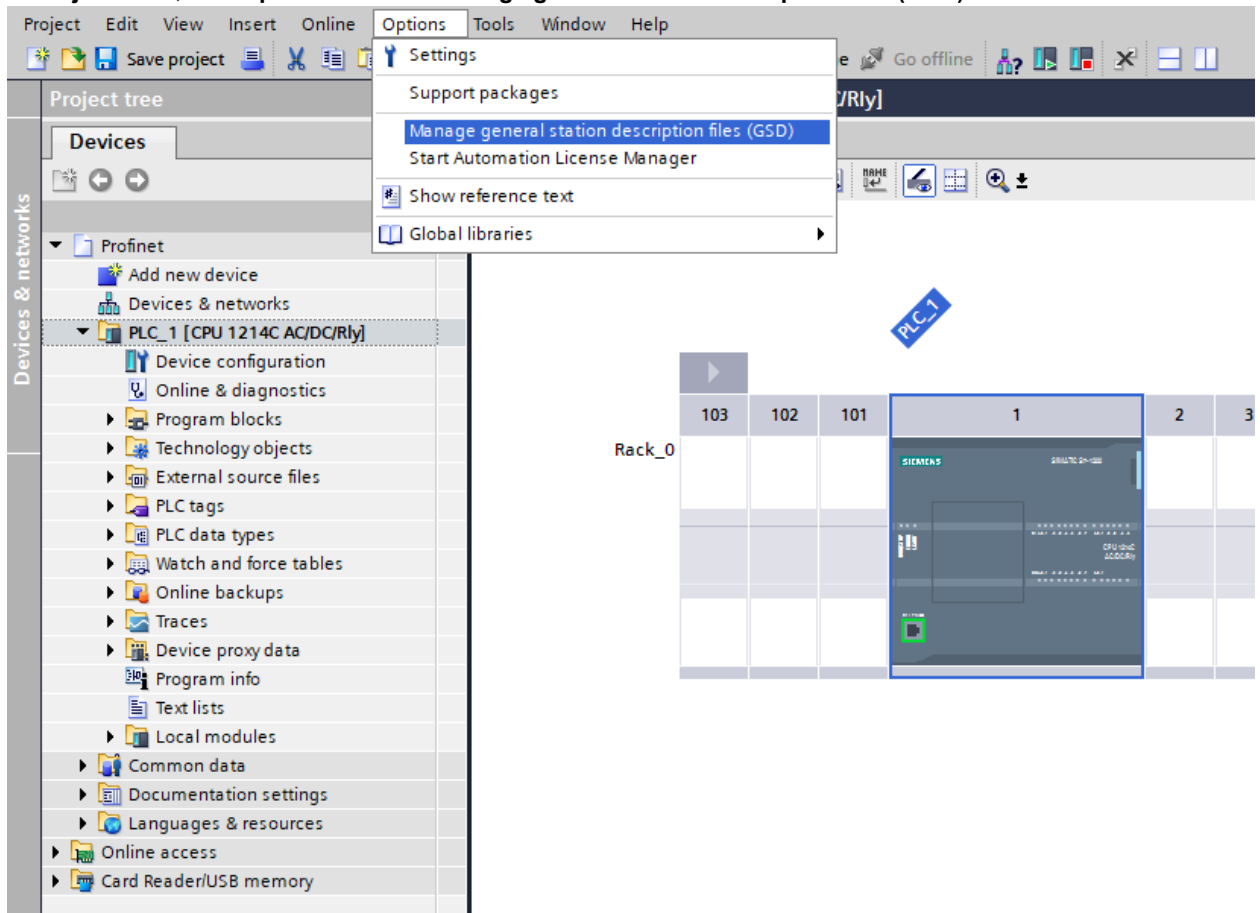

3. Browse to the installation folder of the GSD file (or the location where you saved the GSD file if you downloaded it from the web).
4. Select the GSD file you wish to install and follow the displayed instructions to complete the installation.

Note: If there is more than one GSD file in the list and you are unsure which to install, choose the one with the most recent date.

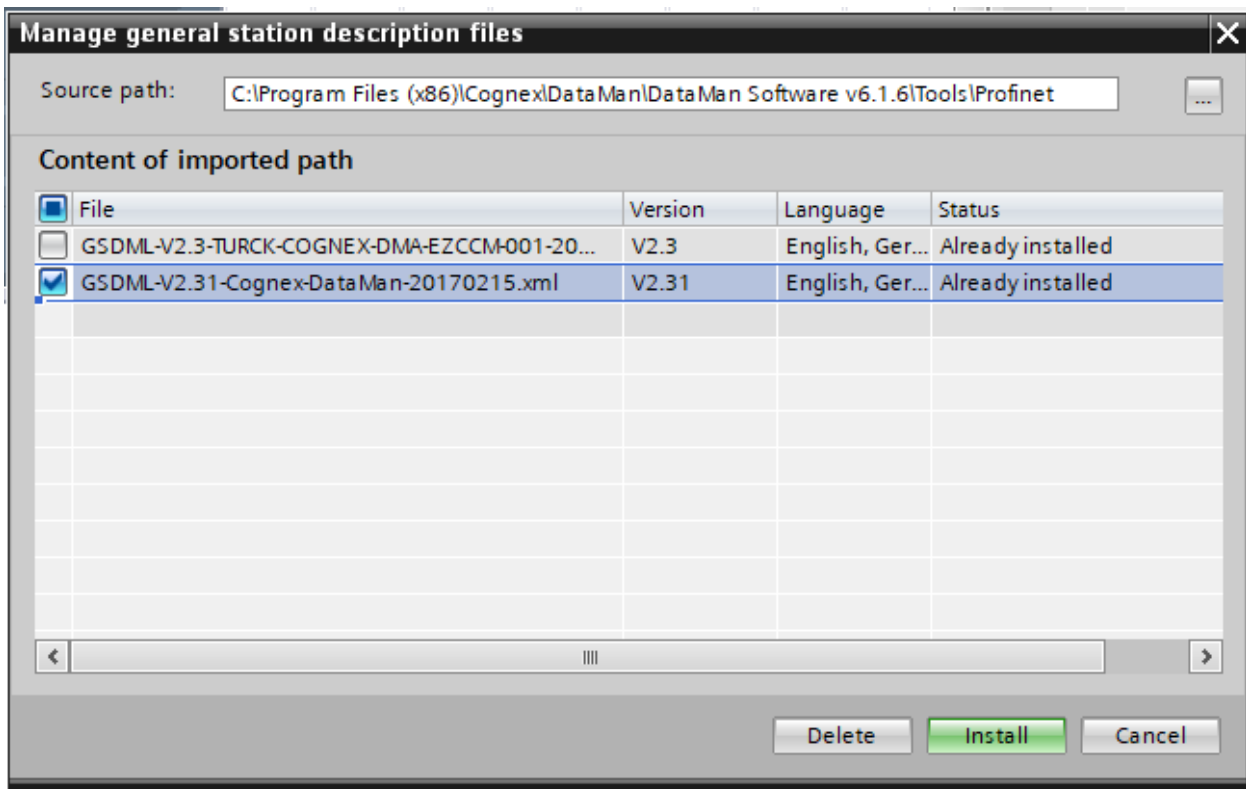

5. Go to **Device Configuration** and add your device in the **Network View** tab.
6. The **Hardware catalog** is displayed on the right. Expand the “PROFINET IO” tree to the “Cognex ID Readers” node.
7. Press and hold the left mouse button to drag the DataMan reader and drop it on the PROFINET IO network symbol in the left pane.

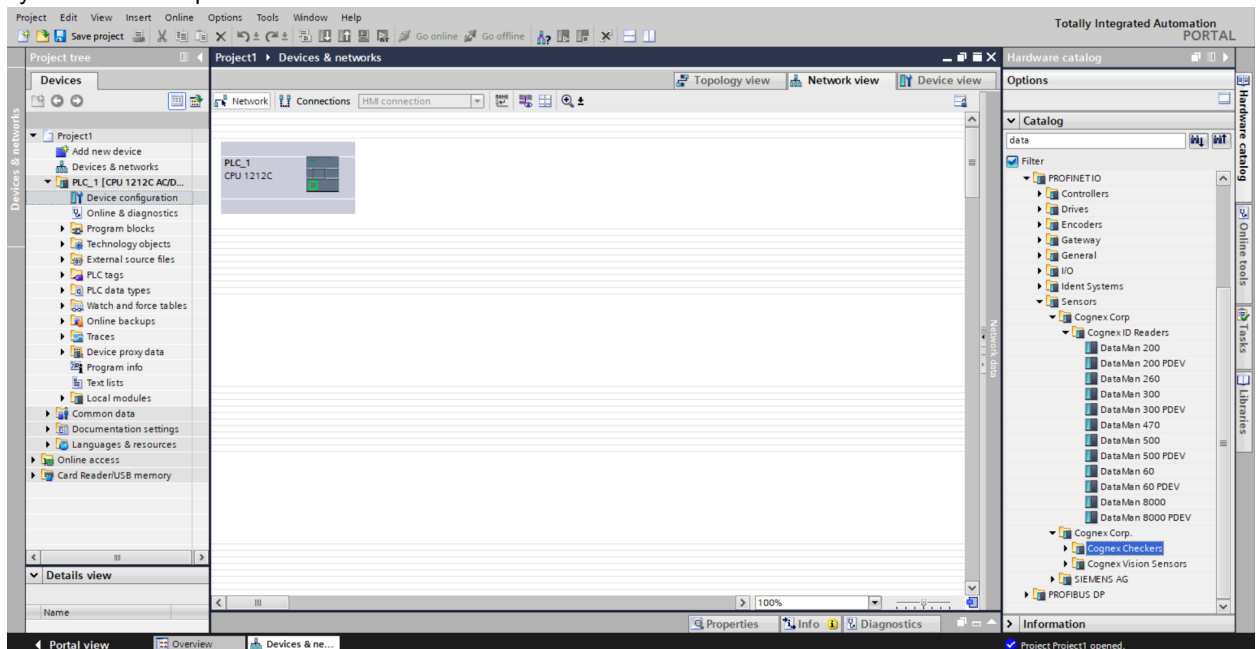

The HW Config tool automatically maps the DataMan I/O modules into the memory space.

Note: By default, the 64 byte User Data and 64 byte Result Data Modules are inserted. There are multiple sizes available for both of these modules. To optimize performance, use the module size that most closely matches the actual data requirements of your application. You can change the module by deleting the one in the table and inserting the appropriate sized module from the catalog.

8. Right-click the DataMan icon and select **Properties...**

The screenshot shows the TIA Portal interface with the following components:

- Project tree:** Profinet > PLC_1 (CPU 1214C AGDGRly) > Distributed IO > PROFINET IO-System (100): PNIE_1 > DataMan
- Device overview table:**

Module	Rack	Slot	I address	Q address	Type
DataMan	0	0			DataMan 300
Interface	0	0 X1			DataMan
Acquisition Control_1	0	1		2	Acquisition Cont...
Acquisition Status_1	0	2	2..4		Acquisition Status
Results Control_1	0	3		3	Results Control
Results Status_1	0	4	5		Results Status
Soft Event Control_1	0	5	6	4	Soft Event Control
User Data - 64 bytes_1	0	6	256..323		User Data - 64 by...
Result Data - 64 bytes_1	0	7	256..327		Result Data - 64...
- Properties dialog (Ethernet addresses):**
 - Interface networked with: Subnet: PNIE_1
 - IP protocol: Use IP protocol
 - Set IP address in the project:
 - IP address: 192.168.0.2
 - Subnet mask: 255.255.255.0
 - Use router: (disabled)
 - IP address is set directly at the device: (selected)
 - PROFINET: Generate PROFINET device name automatically
 - PROFINET device name: dataman

- Give the reader a name. This must match the name of your actual DataMan reader. The name must be unique and follow DNS naming conventions. For details, see the TIA Portal help documentation.
- If your DataMan reader is configured to use its own static IP, select the **IP address is set directly at the device** radio button. As an alternative, if you wish the PLC to assign an IP address, select the Ethernet button and configure the appropriate address.
- Check the checkbox next to the device image and connect the selected device with the PLC by drawing a line with your mouse.

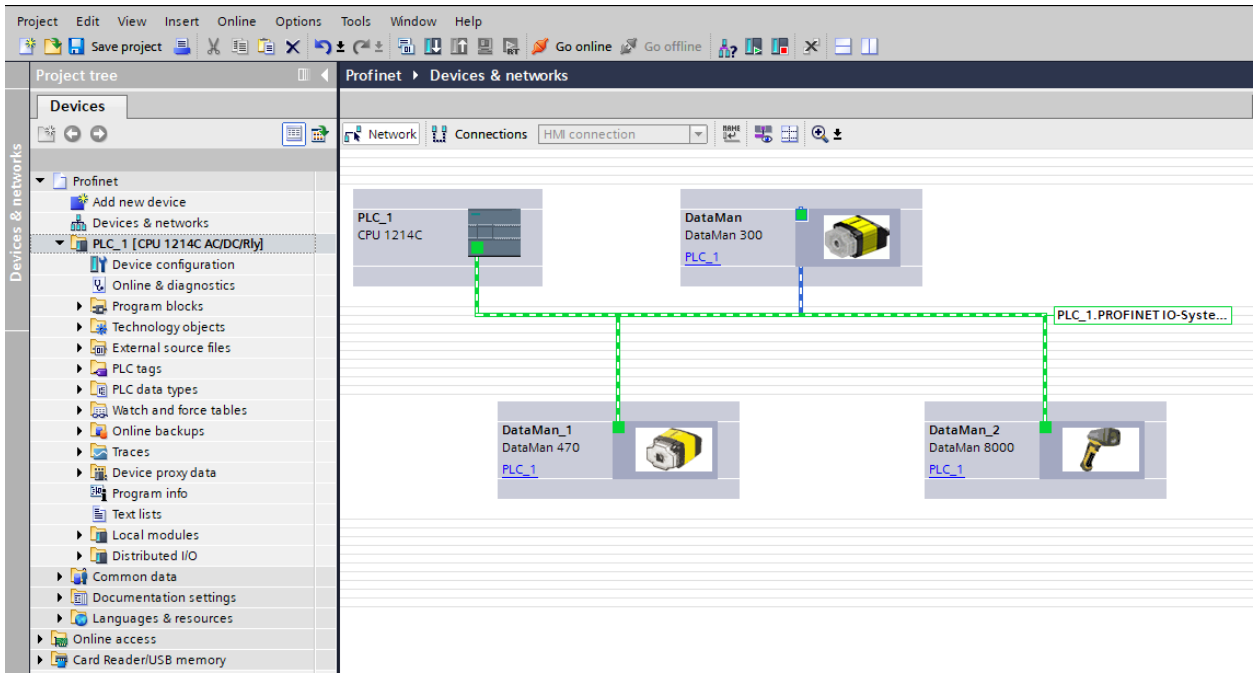

12. By default, the SIMATIC software maps the User Data and Result Data Modules to offset 256. This is outside of the default process image area size of 128. That is, data in these modules are inaccessible by some SFCs such as BLKMOV. As a solution, either remap the modules to lower offsets within the process image area or expand the process image area to include these modules.

If you choose to expand the process image area, make the size large enough for the module size plus the default 256 offset.

Device overview								Options
Module	Rack	Slot	I address	Q address	Type	Article no.		
DataMan	0	0			DataMan 300	DMR-300#-00	▼ Catalog	
Interface	0	0 X1			DataMan		dataman	
Acquisition Control_1	0	1		2	Acquisition Control		Filter	
Acquisition Status_1	0	2	2...4		Acquisition Status		Head module	
Results Control_1	0	3		3	Results Control		DataMan 300	
Results Status_1	0	4	5		Results Status		Module	
Soft Event Control_1	0	5	6	4	Soft Event Control		DataMan Control Modules	
User Data - 64 bytes_1	0	6		256...323	User Data - 64 bytes		Acquisition Control	
Result Data - 64 bytes_1	0	7		256...327	Result Data - 64 bytes		Results Control	
							Soft Event Control	
							DataMan Data Modules	
							Result Data - 128 bytes	
							Result Data - 16 bytes	
							Result Data - 246 bytes	
							Result Data - 32 bytes	
							Result Data - 64 bytes	
							User Data - 128 bytes	
							User Data - 16 bytes	
							User Data - 250 bytes	
							User Data - 32 bytes	
							User Data - 64 bytes	
							DataMan Status Modules	
							Acquisition Status	
							Results Status	

Note: Expanding the process image can have a performance impact on the PLC scan cycle time. If your scan time is critical, use the minimal acceptable module sizes and manually remap them down lower in the process image.

Symbol Table

It is recommended that you define symbols for the DataMan I/O module elements to make the code much easier to read and reduce mistakes. This sample table shows symbols defined for a typical instance of a DataMan reader. It is possible that DataMan I/O modules are at different addresses in your project. Make sure to adjust your symbol definitions based on the specific offsets of the I/O modules. For more information, see the *TIA Portal Integration Guide for In-Sight and DataMan* at <https://support.cognex.com/en/downloads/detail/in-sight/3687/1033>.

	Name	Data type	Address	Retain	Visibl...	Acces...	Comment
1	Dataman-TriggerEnable	Bool	%Q1.0	<input type="checkbox"/>	<input checked="" type="checkbox"/>	<input checked="" type="checkbox"/>	
2	Dataman-Trigger	Bool	%Q1.1	<input type="checkbox"/>	<input checked="" type="checkbox"/>	<input checked="" type="checkbox"/>	
3	Dataman-TriggerReady	Bool	%I1.0	<input type="checkbox"/>	<input checked="" type="checkbox"/>	<input checked="" type="checkbox"/>	
4	Dataman-TriggerAck	Bool	%I1.1	<input type="checkbox"/>	<input checked="" type="checkbox"/>	<input checked="" type="checkbox"/>	
5	Dataman-Acquiring	Bool	%I1.2	<input type="checkbox"/>	<input checked="" type="checkbox"/>	<input checked="" type="checkbox"/>	
6	Dataman-MissedAcq	Bool	%I1.3	<input type="checkbox"/>	<input checked="" type="checkbox"/>	<input checked="" type="checkbox"/>	
7	Dataman-TriggerID	Word	%IW2	<input type="checkbox"/>	<input checked="" type="checkbox"/>	<input checked="" type="checkbox"/>	
8	Dataman-BufferResultsEnable	Bool	%Q2.0	<input type="checkbox"/>	<input checked="" type="checkbox"/>	<input checked="" type="checkbox"/>	
9	Dataman-ResultsAck	Bool	%Q2.1	<input type="checkbox"/>	<input checked="" type="checkbox"/>	<input checked="" type="checkbox"/>	
10	Dataman-Decoding	Bool	%I4.0	<input type="checkbox"/>	<input checked="" type="checkbox"/>	<input checked="" type="checkbox"/>	
11	Dataman-Decode Complete	Bool	%I4.1	<input type="checkbox"/>	<input checked="" type="checkbox"/>	<input checked="" type="checkbox"/>	
12	Dataman-Results Buffer Overrun	Bool	%I4.2	<input type="checkbox"/>	<input checked="" type="checkbox"/>	<input checked="" type="checkbox"/>	
13	Dataman-Results Available	Bool	%I4.3	<input type="checkbox"/>	<input checked="" type="checkbox"/>	<input checked="" type="checkbox"/>	
14	Dataman-General Fault	Bool	%I4.7	<input type="checkbox"/>	<input checked="" type="checkbox"/>	<input checked="" type="checkbox"/>	
15	Dataman-Train Code	Bool	%Q5.0	<input type="checkbox"/>	<input checked="" type="checkbox"/>	<input checked="" type="checkbox"/>	
16	Dataman-Train Match String	Bool	%Q5.1	<input type="checkbox"/>	<input checked="" type="checkbox"/>	<input checked="" type="checkbox"/>	
17	Dataman-Train Focus	Bool	%Q5.2	<input type="checkbox"/>	<input checked="" type="checkbox"/>	<input checked="" type="checkbox"/>	
18	Dataman-Train Brightness	Bool	%Q5.3	<input type="checkbox"/>	<input checked="" type="checkbox"/>	<input checked="" type="checkbox"/>	
19	Dataman-Untrain	Bool	%Q5.4	<input type="checkbox"/>	<input checked="" type="checkbox"/>	<input checked="" type="checkbox"/>	
20	Dataman-Execute DMCC	Bool	%Q5.5	<input type="checkbox"/>	<input checked="" type="checkbox"/>	<input checked="" type="checkbox"/>	
21	Dataman-Set Match String	Bool	%Q5.7	<input type="checkbox"/>	<input checked="" type="checkbox"/>	<input checked="" type="checkbox"/>	
22	Dataman-Train Code Ack	Bool	%I3.0	<input type="checkbox"/>	<input checked="" type="checkbox"/>	<input checked="" type="checkbox"/>	
23	Dataman-Train Match String Ack	Bool	%I3.1	<input type="checkbox"/>	<input checked="" type="checkbox"/>	<input checked="" type="checkbox"/>	
24	Dataman-Train Focus Ack	Bool	%I3.2	<input type="checkbox"/>	<input checked="" type="checkbox"/>	<input checked="" type="checkbox"/>	
25	Dataman-Train Brightness Ack	Bool	%I3.3	<input type="checkbox"/>	<input checked="" type="checkbox"/>	<input checked="" type="checkbox"/>	
26	Dataman-Untrain Ack	Bool	%I3.4	<input type="checkbox"/>	<input checked="" type="checkbox"/>	<input checked="" type="checkbox"/>	
27	Dataman-Execute DMCC Ack	Bool	%I3.5	<input type="checkbox"/>	<input checked="" type="checkbox"/>	<input checked="" type="checkbox"/>	
28	Dataman-Set Match String Ack	Bool	%I3.7	<input type="checkbox"/>	<input checked="" type="checkbox"/>	<input checked="" type="checkbox"/>	
29	Dataman-UserData Option	Word	%QW256	<input type="checkbox"/>	<input checked="" type="checkbox"/>	<input checked="" type="checkbox"/>	
30	Dataman-UserData Length	Word	%QW258	<input type="checkbox"/>	<input checked="" type="checkbox"/>	<input checked="" type="checkbox"/>	

Trigger and Get Results

Open the sample program “Cognex-Dataman” for the complete example program.

Note: This sample can be used with any PROFINET enabled DataMan reader.

Perform the following steps to install the program:

1. Start TIA Portal.
2. Browse to find the sample file on your PC.

File Explorer path: This PC > OS (C:) > Program Files (x86) > Cognex > DataMan > DataMan Software v6.1.6 > Samples > Siemens

Name	Date modified	Type	Size
Cognex-Dataman.zip	5/24/2019 2:28 PM	Compressed (zipp...	2,567 KB
COGNEX-DMA-EZCCM_Profinet.zip	3/25/2019 11:32 AM	Compressed (zipp...	2,815 KB
Dm200_SampleRead.zip	3/19/2019 9:16 AM	Compressed (zipp...	475 KB
Dm200_SoftEvents.zip	3/19/2019 9:16 AM	Compressed (zipp...	493 KB
Dm300_SampleRead.zip	3/19/2019 9:16 AM	Compressed (zipp...	802 KB
Dm300_SoftEvents.zip	3/19/2019 9:16 AM	Compressed (zipp...	801 KB
Dm500_SampleRead.zip	3/19/2019 9:16 AM	Compressed (zipp...	770 KB
Dm500_SoftEvents.zip	3/19/2019 9:16 AM	Compressed (zipp...	787 KB
Dm8000_SampleRead.zip	3/19/2019 9:16 AM	Compressed (zipp...	760 KB
Dm8000_SoftEvents.zip	3/19/2019 9:16 AM	Compressed (zipp...	773 KB

3. Save the project on your PC. TIA Portal extracts the sample archive and makes it available.

Reduced to the basics, the process of reading and retrieving results consists of the following:

1. Define an area in your application to save read results. There are many options regarding how and where result data can be stored. In this example, a temporary tag is defined containing the fields of the Result Data module that are relevant for our application.

13	Latest Results	Struct		
14	ID	Int		
15	Flags	Int		
16	Length	Int		
17	Value	Array[0..63] of Byte		

2. Enable the reader.



3. Set the trigger signal and set coil to indicate a read is pending.

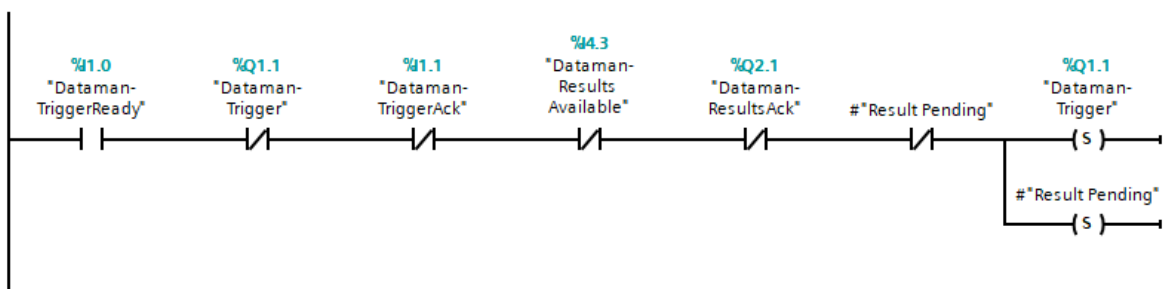

4. As soon as the results are available, clear the trigger signal and save a copy of the result data and set the results acknowledge signal.

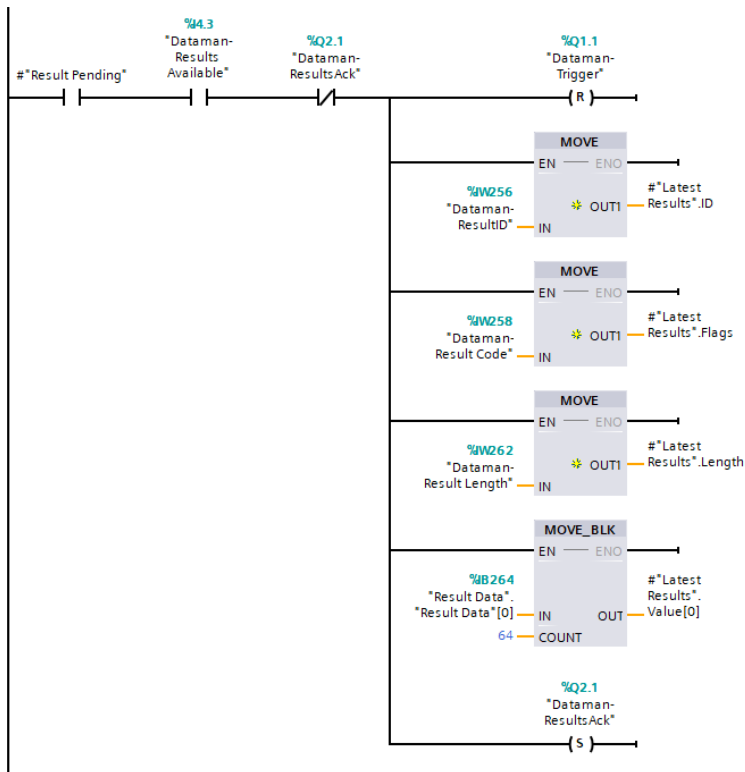

- When the reader sees the result acknowledge signal, clear result acknowledge, clear the read pending coil, and signal that the read process is complete.

Note: The reader clears “Results Available” as soon as it sees the PLC’s “Results Ack” signal.

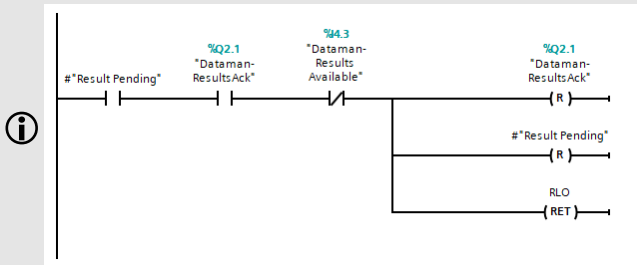

Using SoftEvents

SoftEvents are a means of invoking an activity by manipulating a single control bit. The activity for each bit is predefined. For more details, see section [SoftEvents](#). With the exception of “Execute DMCC” and “Set Match String” all SoftEvents may be invoked in the same way. “Execute DMCC” and “Set Match String” require the added step of loading the User Data module with application data before invoking the event.

Reduced to the basics, the process of invoking a SoftEvent consists of the following:

Issue “Train Focus” signal.

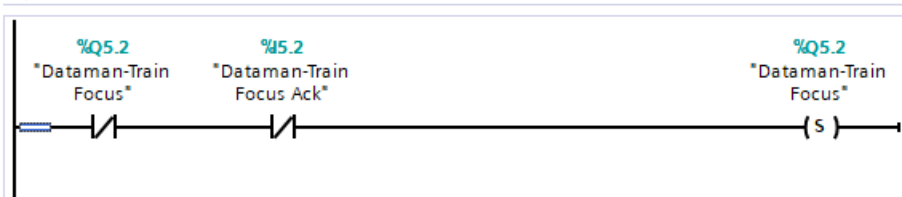

► Release "Train Focus" signal as soon as it is acknowledged by the ...

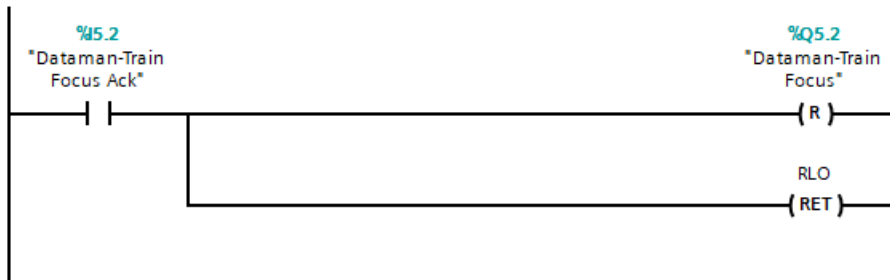

Executing DMCC Commands

Refer to sample program "Cognex-Dataman" for the complete example program. For information on how to install it, see section [Using SoftEvents](#).

Note: This sample can be used with any PROFINET enabled DataMan reader.

"Execute DMCC" is a SoftEvent which requires the added step of loading the User Data module with the desired DMCC command string before invoking the event. Note that the SoftEvent mechanism does not provide a means of returning DMCC response data (other than a failure indication). So this mechanism cannot be used for DMCC "||>GET..." commands.

The process of executing a DMCC command is the same for all other SoftEvents (see example above) except the step of invoking the SoftEvent also includes copying the command string to the User Data Module. In this example the command string is exists in a Data Block. This example can be expanded to utilize a Data Block with an array of command strings that the copy function can reference by an index value. This allows the user to pre-define all DMCC commands that are required by the application and invoke them by index.

► Copy the DMCC command, and then issue the...

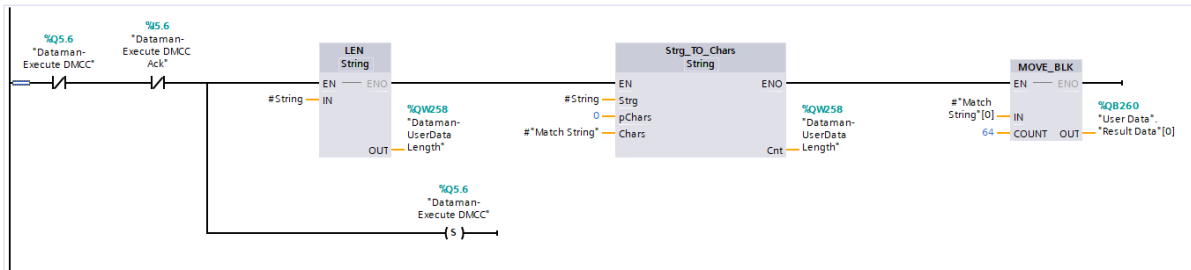

Release "Execute DMCC" signal as soon as it is acknowledged by the reader.

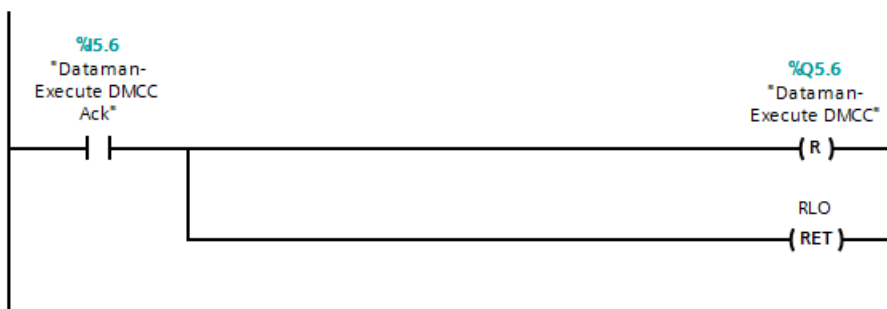

SLMP Protocol

The SLMP Protocol uses standard Ethernet hardware and software to exchange I/O data, alarms, and diagnostics. It is Mitsubishi Electric's publicly available, standardized communication format for communicating with Q, iQ and L Series PLCs through Ethernet or serial connections. DataMan supports SLMP Protocol on Ethernet only.

By default, the DataMan has SLMP Protocol disabled. The protocol can be enabled in the Setup Tool, via DMCC, or by scanning a configuration code.

Note: If you have a wireless DataMan reader, see section [Industrial Protocols for the Wireless DataMan on page 116](#).

DMCC

The following commands can be used to enable/disable SLMP Protocol. The commands can be issued via RS-232 or Telnet connection.

Note: Use a third party Telnet client such as PuTTY to communicate with your DataMan reader.

Enable:

```
||>SET SLMP-PROTOCOL.ENABLED ON
||>CONFIG.SAVE
||>REBOOT
```

Disable:

```
||>SET SLMP-PROTOCOL.ENABLED OFF
||>CONFIG.SAVE
||>REBOOT
```

Reader Configuration Code

Scanning the following reader configuration codes enables/disables SLMP Protocol for your corded reader.

Note: You must reboot the device for the change to take effect.



Scanning the following reader configuration codes enables/disables SLMP protocol on your DataMan 8000 base station.

Note: You must reboot the device for the change to take effect.



SLMP Protocol Scanner

SLMP Protocol on DataMan is implemented as a client type device also referred to as a scanner. The DataMan reader initiates all communication in the form of read and write requests. The PLC acts as a passive server reacting to the read and write requests. Since the PLC cannot initiate communication, it relies on the reader to periodically ask (scan) the PLC for any actions or information that the PLC requires, such as triggering or retrieving read results.

Getting Started

By default, SLMP Protocol is not enabled on the DataMan reader. The protocol must be enabled and the protocol configuration parameters must be set to correctly interact with a PLC. Protocol configuration is accomplished via the DataMan Setup Tool.

In the Setup Tool's **Communications** application step's **Ethernet** tab, check **SLMP Protocol** to enable this industrial protocol.

The screenshot shows the 'DataMan Setup Tool - DM374-DOF [10.86.80.36]' interface. The 'Communications' tab is selected, and the 'Advanced' sub-tab is active. The configuration is set to use a static IP address of 169.254.16.31 with a subnet mask of 255.255.0.0. The SLMP Protocol is the only enabled industrial protocol. The PLC series is QCPU. A table of PLC data points is shown below the protocol settings.

Name	Selected Device	Offset	Number of Devices	Description
Control	None	0	0	Vision control ...
Status	None	0	0	Vision status ...
PLC Input	None	0	0	User data blo...
PLC Output	None	0	0	Inspection res...
Command	None	0	0	Command stri...
Command R...	None	0	0	Command res...

Make sure to save the new selection by clicking the **Save Settings** button in the upper toolbar before disconnecting from the reader.

Note: The new settings take effect only after the reader is rebooted.

SLMP Protocol configuration consists of two aspects: defining the network information and defining the data to be exchanged. All configuration parameters are accessed via the SLMP Protocol tab.

You must modify the **IP Address** to match the address of your PLC. In addition, modify **Network Number**, **PC Number** and **Destination Module** if they differ from your network.

Network Configuration

The network configuration defines all the information that the DataMan reader needs to establish a connection with a PLC.

Name	Default	Range	Description
IP Address	<empty >	Any valid IP address	IP Address of the PLC to connect to.
Host Port (Hex)	3000	Any Hex port number 1000-FFFF	Port number of the SLMP Protocol channel on the PLC.
Timeout (ms)	1000	5 - 30000	Time to in milliseconds for a response from the PLC to an SLMP Protocol message.
Poll Interval (ms)	1000	10 - 30000	Requested time in milliseconds between successive polls of the Control Block from the PLC.
PLC Series	QCPU	QCPU or LCPU	Defines frame type used. Currently only 3E supported.
Network Number	0	0 - 239	SLMP Protocol network number to communicate with (0 = local network).
PC Number	0xFF	1 -120 = station on CC-Link IE field network adapter 126 = Master station on CC-Link IE field network 255 = Direct connect to local station	Station identifier on the specified network of the destination module.
Destination Module	0x3FF	0x3ff = Local station (default) 0x3d0 = Control system CPU 0x3d1 = Standby system CPU 0x3d2 = System A CPU 0x3d3 = System B CPU 0x3e0 = CPU 1 0x3e1 = CPU 2 0x3e2 = CPU 3 0x3e3 = CPU 4	Module identifier of the device to connect to.

Data Block Configuration

The data block configuration defines the data that will be exchanged between the DataMan reader and the PLC. Six data blocks are available. Each block has a predefined function.

Not all data blocks are required. Configure only those data blocks which your application needs. Typically the Control and Status blocks are defined because they control most data flow. However, there are some use cases where even these blocks are not required.

A data block is configured by defining the PLC Device type (that is, memory type), Device offset and Number of Devices contained in the data block. If either the Device type or Number of Devices is undefined, that block will not be used. That is, no data is exchanged for that block.

Block Name	Supported Device Types	Offset	Number of Devices
Control	<none>, D, W, R, ZR, M, X, Y, L, F, B	0 - 65535	0, if type <none> 32, if bit type 2, if word type (read-only)
Status	<none>, D, W, R, ZR, M, X, Y, L, F, B	0 - 65535	0, if type <none> 32, if bit type 2, if word type (read-only)
PLC Input	None, D, W, R, ZR	0 - 65535	0 - 960
PLC Output	None, D, W, R, ZR	0 - 65535	0 - 960
Command	None, D, W, R, ZR	0 - 65535	0 - 960
Command Result	None, D, W, R, ZR	0 - 65535	0 - 960

Interface

This section describes the interface to the DataMan reader as seen by the PLC via SLMP Protocol. The interface model consists of six data blocks grouped in three logical pairs:

- Control and Status
- PLC Input and PLC Output
- Command and Command Response

Not all of the blocks are required. You may select which blocks are appropriate for your particular application. However, Control and Status will generally be included for most applications.

You can define the starting address and device type for each interface block that you choose to use in your application. Undefined blocks will not be exchanged. For any transfer (read or write) the entire block is sent, even if only one field within the block has changed value. The protocol implementation will minimize network use by grouping as many value changes as logically possible into a single transfer.

Control Block

The Control block contains bit type data. However, the block may be defined to exist in either bit or word memory in the PLC. This block consists of the control signals sent from the PLC to the reader. It is used by the PLC to initiate actions and acknowledge certain data transfers. Control Block

Bit 7	Bit 6	Bit 5	Bit 4	Bit 3	Bit 2	Bit 1	Bit 0
Reserved				Results Ack	Buffer Results Enable	Trigger	Trigger Enable
Bit 15	Bit 14	Bit 13	Bit 12	Bit 11	Bit 10	Bit 9	Bit 8
Reserved							
Bit 23	Bit 22	Bit 21	Bit 20	Bit 19	Bit 18	Bit 17	Bit 16
Reserved						Initiate String Cmd	Set User Data
Bit 31	Bit 30	Bit 29	Bit 28	Bit 27	Bit 26	Bit 25	Bit 24
SoftEvent 7	SoftEvent 6	SoftEvent 5	SoftEvent 4	SoftEvent 3	SoftEvent 2	SoftEvent 1	SoftEvent 0

Control Block Field Descriptions

Bit	Name	Description
0	Trigger Enable	This field is set to enable triggering via the <i>Trigger</i> bit. Clear this field to disable the network triggering mechanism.
1	Trigger	Setting this bit triggers an acquisition. Note: The <i>Trigger Ready</i> bit must be set high before triggering an acquisition.
2	Buffer Results Enable	When this bit is set, each read result set (<i>ResultID</i> , <i>ResultCode</i> , <i>ResultLength</i> and <i>ResultData</i> fields) will be held in the <i>Output Block</i> until it is acknowledged. Once acknowledged, the next set of read results will be made available from the buffer. If new read results arrive before the earlier set is acknowledged, the new set will be queued in the reader's buffer. Up to 6 sets of read results can be held in the reader's buffer. Refer to Section Operation for a description of the acknowledgement handshake sequence.
3	ResultsAck	Set by the PLC to acknowledge that it has received the latest results (<i>ResultID</i> , <i>ResultCode</i> , <i>ResultLength</i> and <i>ResultData</i> fields). When the reader sees this bit transition from 0 to 1, it clears the <i>ResultsAvailable</i> bit. This forms a logical handshake between the PLC and reader. If result buffering is enabled, the acknowledgement will cause the next set of queued results to be moved from the buffer. See section Operation for a description of the acknowledgement handshake sequence.
4-15	Reserved	Reserved for future use.
16	SetUserData	Set by the PLC to signal that new <i>UserData</i> is available. After reading the new <i>UserData</i> , the reader sets <i>SetUserDataAck</i> to signal that the transfer is complete. This forms a logical handshake between the PLC and reader.
17	Initiate StringCmd	Set by the PLC to signal that a new <i>StringCommand</i> is available. After processing the command, the reader sets <i>StringCmdAck</i> to signal that the command result is available. This forms a logical handshake between the PLC and reader.
18-23	Reserved	Future use
24-31	SoftEvents	Bits act as virtual discrete inputs. When a bit transitions from 0 to 1, the associated action is executed. After executing the action, the reader sets the corresponding <i>SoftEventAck</i> to signal that the action is complete. This forms a logical handshake between the PLC and reader. Bit0: Train code Bit1: Train match string Bit2: Train focus Bit3: Train brightness Bit4: Un-Train Bit5: Reserved (future use) Bit6: Execute DMCC command Bit7: Set match string

Status Block

The status block contains bit type data. The block can also be defined to exist in either bit or word memory in the PLC. This block consists of the status signals sent from the reader to the PLC. The reader uses it to signal status and handshake certain data transfers.

Bit 7	Bit 6	Bit 5	Bit 4	Bit 3	Bit 2	Bit 1	Bit 0
Reserved				Missed Acq	Acquiring	Trigger Ack	Trigger Ready
Bit 15	Bit 14	Bit 13	Bit 12	Bit 11	Bit 10	Bit 9	Bit 8
General Fault	Reserved			Results Available	Results Buffer Overrun	Decode Complete Toggle	Decoding
Bit 23	Bit 22	Bit 21	Bit 20	Bit 19	Bit 18	Bit 17	Bit 16
Reserved						String Cmd Ack	Set User Data Ack
Bit 31	Bit 30	Bit 29	Bit 28	Bit 27	Bit 26	Bit 25	Bit 24
SoftEvent Ack 7	SoftEvent Ack 6	SoftEvent Ack 5	SoftEvent Ack 4	SoftEvent Ack3	SoftEvent Ack 2	SoftEvent Ack 1	SoftEvent Ack 0

Status Block Field Descriptions

Bit	Name	Description
0	Trigger Ready	Indicates when the reader is ready to accept a new <i>Trigger</i> . The reader sets this bit when <i>TriggerEnable</i> has been set and the reader is ready to accept a new trigger.
1	Trigger Ack	Indicates when the reader recognizes that <i>Trigger</i> has been set. This bit remains set until the <i>Trigger</i> bit is clear.
2	Acquiring	Set to indicate that the reader is in the process of acquiring an image.
3	Missed Acq	Indicates that the reader missed a requested acquisition trigger. The bit is cleared when the next acquisition is issued.
4-7	Reserved	Future use
8	Decoding	Set to indicate that the reader is in the process of decoding an image.
9	Decode Complete Toggle	Indicates new result data is available. Bit toggles state (0 to 1 or 1 to 0) each time new result data becomes available.
10	Results Buffer Overrun	Set to indicate that the reader has discarded a set of read results because the PLC has not acknowledged the earlier results. Cleared when the next set of result data is successfully queued in the buffer. This bit only has meaning if result buffering is enabled.
11	Results Available	Set to indicate that new result data is available. Bit will remain set until acknowledged with <i>ResultsAck</i> even if additional new read results become available.
12-14	Reserved	Future use
15	General Fault	Set to indicate that an Ethernet communications fault has occurred. Currently only used by SoftEvent operations. Bit will remain set until the next successful SoftEvent or until <i>TriggerEnable</i> is set low and then high again.
16	Set User Data Ack	Set to indicate that the reader has received new <i>UserData</i> . Bit will remain set until the corresponding <i>SetUserData</i> bit is cleared. This forms a logical handshake between the PLC and reader.
17	String Cmd Ack	Set to indicate that the reader has completed processing the latest string command and that the command response is available. Bit will remain set until the corresponding <i>InitiateStringCmd</i> bit is cleared. This forms a logical handshake between the PLC and reader.
18-23	Reserved	Future use

Bit	Name	Description
24-31	SoftEvent Ack	Set to indicate that the reader has completed the SoftEvent action. Bit will remain set until the corresponding SoftEvent bit is cleared. This forms a logical handshake between the PLC and reader. Bit0: Ack train code Bit1: Ack train match string Bit2: Ack train focus Bit3: Ack train brightness Bit4: Ack untrain Bit5: Reserved (future use) Bit6: Ack Execute DMCC command Bit7: Ack set match string

Input Data Block

The Input Data block contains word type data. This is data sent from the PLC to the reader. The block consists of user defined data that may be used as input to the acquisition/decode operation.

Word 0	Word 1	Word 2..N
Reserved	User Data Length	User Data

Input Data Block Field Descriptions

Word	Name	Description
0	Reserved	Future use
1	User Data Length	Number of bytes of valid data actually contained in the <i>UserData</i> field.
2..N	User Data	User defined data that may be used as an input to the acquisition/decode.

Output Data Block

The Output Data block contains word type data. This is data sent from the reader to the PLC. The block consists primarily of read result data.

Word 0	Word 1	Word 2	Word 3	Word 4	Word 5..N
Reserved	Trigger ID	Result ID	Result Code	Result Length	Result Data

Output Data Block Field Descriptions

Word	Name	Description
0	Reserved	Future use
1	Trigger ID	Trigger identifier. Identifier of the next trigger to be issued. Used to match issued triggers with result data that is received later. This same value will be returned as the ResultID of the corresponding read.
2	Result ID	Result set identifier. This is the value of TriggerID when the corresponding trigger was issued. Used to match up triggers with corresponding result data.

Word	Name	Description
3	Result Code	Indicates the success or failure of the read that produced this result set. Bit0: 1=Read, 0=No read Bit1: 1=Validated, 0=Not Validated Bit2: 1=Verified, 0=Not Verified Bit3: 1=Acquisition trigger overrun Bit4: 1=Acquisition buffer overrun Bit5-15: Reserved (future use)
4	Result Data Length	Number of bytes of valid data actually in the ResultData field.
5..N	Result Data	Result data from this acquisition/decode.

String Command Block

The String Command block contains word type data. This is data sent from the PLC to the reader. The block is used to transport string based commands (DMCC) to the reader.

Note: Do not send string commands that change the reader configuration at the same time as reads are being triggered. Changing configuration during acquisition/decode can lead to unpredictable results.

Word 0	Word 1..N
Length	String Command

String Command Block Field Descriptions

Word	Name	Description
0	Length	Number of bytes of valid data in the <i>StringCommand</i> field.
1..N	String Command	ASCII text string containing the command to execute. No null termination required.

String Command Result Block

The String Command Result block contains word type data. This is data sent from the reader to the PLC. The block is used to transport the response from string based commands (DMCC) to the PLC.

Word 0	Word 1	Word 2..N
Result Code	Length	String Command Result

String Command Result Block Field Descriptions

Word	Name	Description
0	Result Code	Code value indicating the success or failure of the command. Refer to the <i>Command Reference</i> , available through the Windows Start menu or the DataMan Setup Tool Help menu.
1	Length	Number of bytes of valid data in the <i>StringCommand</i> field.
2..N	String Command Result	ASCII text string containing the command to execute. No null termination required.

Operation

SLMP Protocol is a command/response based protocol. All communications are originated from the DataMan reader. The reader must send read requests to the PLC at a periodic interval to detect changes in the control bits.

Scanning

To initiate actions or control data transfer, the PLC changes the state of certain bits of the Control block. Since only the reader can initiate communications, the reader scans (that is, reads the Control block from the PLC) at a periodic rate. This rate is user-defined.

After each scan, the reader will process changes in state of the bits in the Control block. Some state changes require additional communications with the PLC, such as writing updated acknowledge bit values or reading a new string command. The reader handles these additional communications automatically. Other state changes initiate activities such as triggering a read or executing a SoftEvent. The reader performs the requested action and later reports the results.

For any transfer (read or write), the entire interface block is sent, even if only one field within the block has changed value. The protocol implementation will minimize network usage by grouping as many value changes as logically possible into a single transfer.

Typical Sequence Diagram

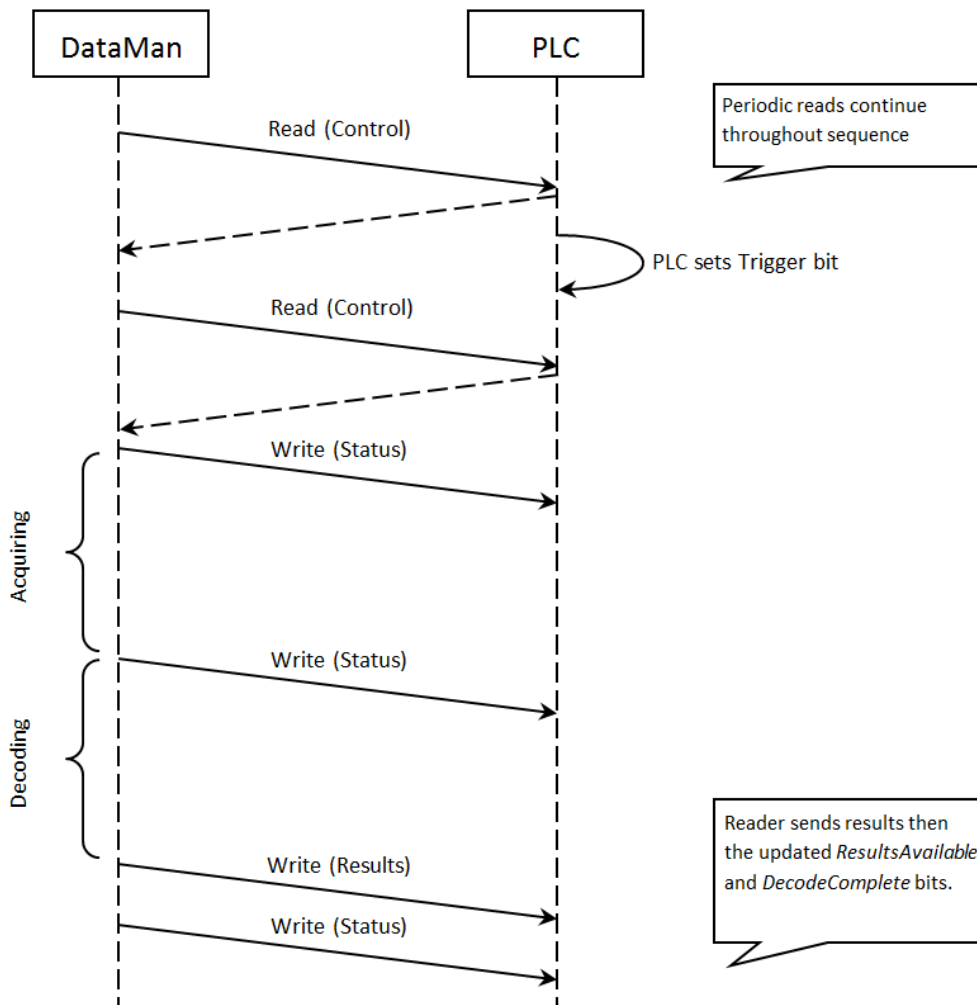

Handshaking

A number of actions are accomplished by means of a logical handshake between the reader and the PLC: triggering, transferring results, executing SoftEvents, string commands, and so on. This ensures that both sides of a transaction know the state of the operation on the opposite side. Network transmission delays always introduce a finite time delay in transfer data and signals. Without this handshaking, one side of a transaction might not detect a signal state change on the other side. Any operation that has both an initiating signal and corresponding acknowledge signal uses this basic handshake procedure.

The procedure involves a four-way handshake.

1. Assert signal
2. Signal acknowledge
3. De-assert signal
4. De-assert acknowledge

The requesting device asserts the signal to request an action (set bit 0 to 1). When the target device detects the signal and the requested operation is complete, it asserts the corresponding acknowledge (set bit 0 to 1). When the requesting device detects the acknowledge, it de-asserts the original signal (1 to 0). Finally, when the target device detects the original signal de-asserted, it de-asserts its acknowledge (bit 0 to 1). To function correctly, both sides must see the complete assert/de-assert cycle (0 to 1 and 1 to 0). The requesting device should not initiate a subsequent request until the cycle completes.

Acquisition Sequence

DataMan can be triggered to acquire images by several methods. It can be done via the SLMP Protocol by setting the *Trigger* bit or issuing a trigger String Command, by DMCC (Telnet), or hardwired trigger signal. This section describes the *Trigger* bit method.

On startup the *TriggerEnable* will be False. It must be set to True to enable triggering via the SLMP Protocol *Trigger* bit. When the device is ready to accept triggers, the reader will set the *TriggerReady* bit to True.

While the *TriggerReady* bit is True, each time the reader detects the *Trigger* bit change from 0 to 1, it initiates a read. Make sure that the *Trigger* bit is held in the new state until that same state value is seen in the *TriggerAck* bit. This is a necessary handshake to guarantee that the reader detects the trigger.

During an acquisition, the *TriggerReady* bit will be cleared and the *Acquiring* bit will be set to True. When the acquisition is completed, the *Acquiring* bit will be cleared. When the device is ready to begin another image acquisition, the *TriggerReady* bit will again be set to True.

If results buffering is enabled, the reader will allow overlapped acquisition and decoding operations. *TriggerReady* will be set high after acquisition is complete but while decoding is still in process. This can be used to achieve faster overall trigger rates. If result buffering is not enabled, the *TriggerReady* bit will remain low until both the acquisition and decode operations are complete.

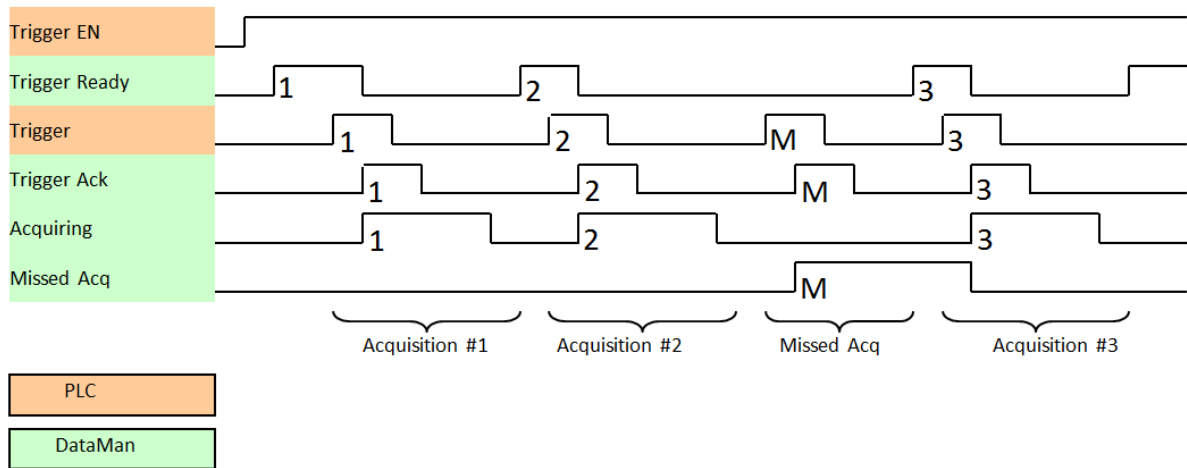

To force a reset of the trigger mechanism, set the *TriggerEnable* to False until *TriggerReady* is also set to False. Then, *TriggerEnable* can be set to True to re-enable acquisition.

As a special case, an acquisition can be cancelled by clearing the *Trigger* signal before the read operation is complete. This allows for canceling reads in Presentation and Manual mode if no code is in the field of view. To ensure that a read is not unintentionally cancelled, make sure that the PLC holds the *Trigger* signal True until both *TriggerAck* and *ResultsAvailable* are True (or *DecodeComplete* toggles state).

Decode / Result Sequence

After an image is acquired, it is decoded. While being decoded, the *Decoding* bit is set. When the decode operation is complete, the *Decoding* bit is cleared. The *ResultsBufferEnable* determines how the reader handles decode results.

If *ResultsBufferEnable* is set to False, the read results are immediately placed into the Output Data block, *ResultsAvailable* is set to True and *DecodeComplete* is toggled.

If *ResultsBufferEnable* is set to True, the new results are queued in a buffer and *DecodeComplete* is toggled. The earlier read results remain in the Output Data block until the PLC acknowledges them. After the acknowledgment handshake, if there are more results in the queue, the next set of results will be placed in the Output Data block and *ResultsAvailable* is set to True.

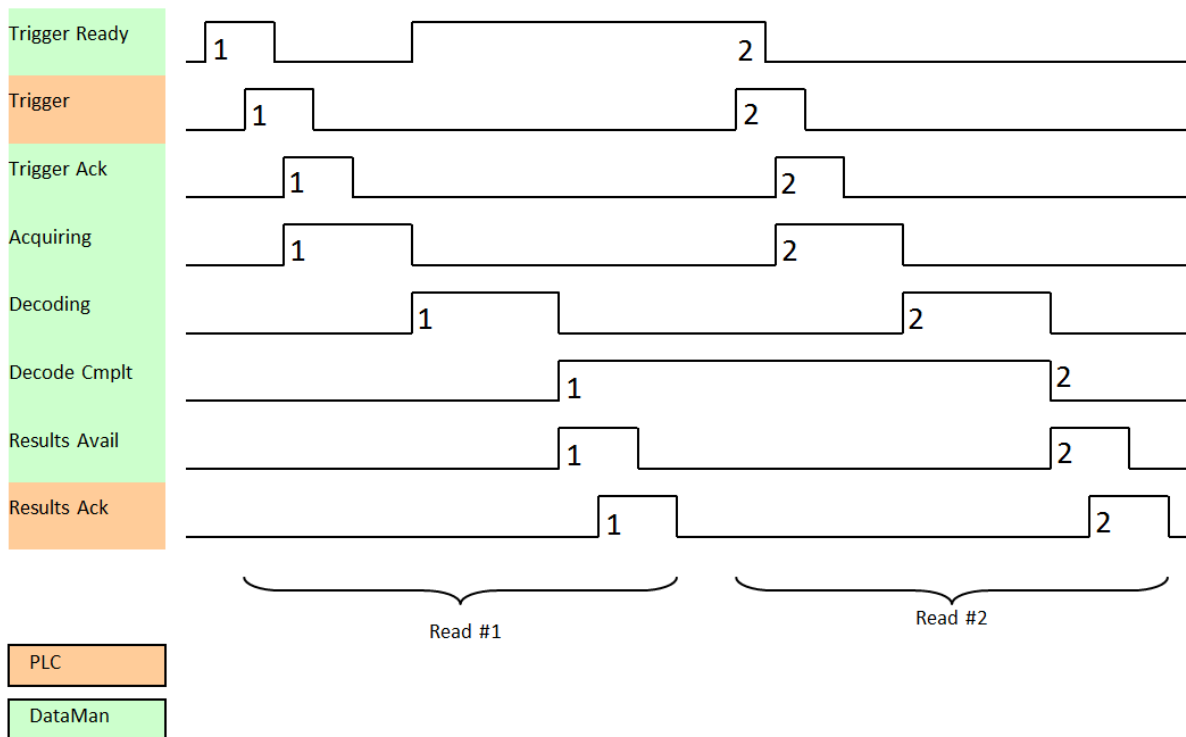

Results Buffering

There is an option to enable a queue for read results. If enabled, this allows a finite number of sets of result data to be queued up until the PLC has time to read them. This is useful to smooth out data flow if the PLC slows down for short periods of time.

If result buffering is enabled, the reader will allow overlapped acquisition and decode operations. Depending on the application this can be used to achieve faster overall trigger rates. For more information, see the [Acquisition Sequence](#) description.

In general, if reads are occurring faster than results can be sent out, the primary difference between buffering or not buffering determines which results get discarded. If buffering is not enabled, the most recent results are kept and the earlier result, which the PLC did not read quickly enough, is lost. The more recent result overwrites the earlier result. If buffering is enabled and the queue becomes full, the most recent results are discarded until space becomes available in the results queue.

Note: If the queue has overflowed and then buffering is disabled, there will be a greater than 1 difference between the TriggerID and ResultID values. This difference represents the number of reads that occurred but could not be queued because the queue was full (number of lost reads equals TriggerID - ResultID - 1). After the next read, the ResultID value will return to the typical operating value of TriggerID - 1.

SoftEvents

SoftEvents act as “virtual” inputs. When the value of a *SoftEvent* bit changes from 0 to 1, the action associated with the event is executed. When the action completes, the corresponding *SoftEventAck* bit will change from 0 to 1 to signal completion.

The *SoftEvent* and *SoftEventAck* form a logical handshake. After *SoftEventAck* changes to 1, the original *SoftEvent* should be set back to 0. When that occurs, *SoftEventAck* will automatically be set back to 0.

WARNING: Do not execute SoftEvents that change the reader configuration at the same time that reads are being triggered. Changing configuration during acquisition/decode can lead to unpredictable results.

Note: The “ExecuteDMCC” and “SetMatchString” SoftEvent actions require user supplied data. This data must be written to the *UserData* and *UserDataLength* area of the Input Data block prior to invoking the SoftEvent. Since both of these SoftEvents depend on the *UserData*, only one may be invoked at a time.

String Commands

The DataMan SLMP Protocol implementation includes a String Command feature. This feature allows you to execute string-based DMCCs over the SLMP protocol connection. The DMCC is sent to the reader through the String Command block. The DMCC result is returned through the String Command Result block. Initiating a command and notification of completion is accomplished by signaling bits in the Control and Status blocks.

To execute a DMCC, the command string is placed in the data field of the String Command block. The command string consists of standard ASCII text. The same command format is used for a serial (RS-232) or Telnet connection. The string does not need to be terminated with a null character. Instead, the length of the string (that is, the number of ASCII characters) is placed in the length field of the String Command block.

After executing the DMCC, the result string is returned in the String Command Result block. Similar to the original command, the result string consists of ASCII characters in the same format that is returned through a serial or Telnet connection. Also, there is no terminating null character. Instead the length of the result is returned in the Command String Result length field. The Command String Result block also contains a numeric result code. This allows you to determine the success or failure of the command without having to parse the text string. The values of the result code are defined in the DMCC documentation.

General Fault Indicator

When an SLMP Protocol communication-related fault occurs, the “GeneralFault” bit will change from 0 to 1. Currently the only fault conditions supported are SoftEvent operations. If a SoftEvent operation fails, the fault bit will be set. The fault bit will remain set until the next successful SoftEvent operation, or, until *TriggerEnable* is set to 0 and then back to 1.

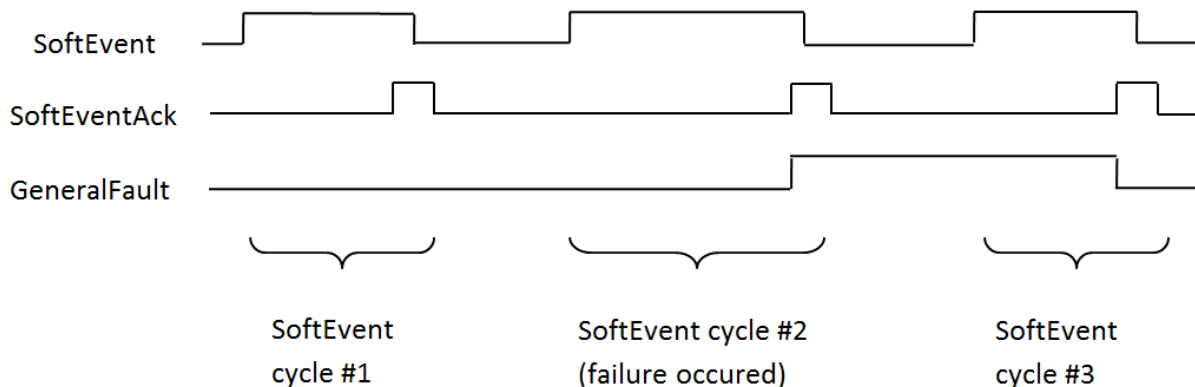

Examples

Included with the DataMan Setup Tool installer is an example PLC program created with Mitsubishi (GX Works2) software. This program demonstrates the DataMan ID readers’ capabilities and proper operation. You can do the same operations by using more advanced features and efficient programming practices with Mitsubishi PLCs. For demonstration purposes, the sample program is used.

Function

The example application demonstrates the following operations:

1. Triggering a read
2. Getting read results
3. Executing string commands (DMCC)

4. Executing SoftEvent operations

- a. Train code
- b. Train match string
- c. Train focus
- d. Train brightness
- e. Un-train
- f. Execute DMCC
- g. Set match string

The “Main” program contains a PLC ladder rung to invoke each of these operations. The operation is invoked by toggling the control bit on the rung from 0 to 1. This invokes the associated subroutine to perform the operation. When the operation is complete, the subroutine sets the control bit back to 0.



Triggering a Read

The example provides two trigger options; “Continuous Trigger” and “Single Trigger”. As the name implies, enabling the “Continuous Trigger” bit will invoke a continuous series of read operations. Once enabled, the “Continuous Trigger” control bit will remain set until you disable it. The “Single Trigger” control bit invokes a single read operation. This control bit will automatically be cleared when the read is completed.

Primarily, the trigger subroutine manages the trigger handshake operation between the PLC and the reader. The control *Trigger* bit is set, the PLC waits for the corresponding *TriggerAck* status bit from the reader, and the control *Trigger* bit is reset. Refer to a description of handshaking in section [Operation](#).

The trigger subroutine contains a delay timer. This is not required for operation. It exists simply to add an adjustable artificial delay between reads for demonstration purposes.

Getting Read Results

For this example the operation of triggering a read and getting read results were intentionally separated. This is to support the situation where the PLC is not the source of the read trigger. For example, the reader may be configured to use a hardware trigger. In such a case, only the get results subroutine would be needed.

Like the triggering subroutine, the get results subroutine manages the results handshake operation between the PLC and the reader. However, it also copies the result data to internal storage. The routine waits for the *ResultsAvailable* status bit to become active, it copies the result data to internal storage, and then executes the *ResultsAck* handshake. Refer to a description of handshaking in section [Operation](#).

The read result consists of a *ResultCode*, *ResultLength*, and *ResultData*. Refer to section [Output Data Block Field Descriptions](#) for details of the *ResultCode* values. The *ResultLength* field indicates how many bytes of actual result data exist in the *ResultData* field. The subroutine converts this byte length to word length before copying the results to internal storage.

The get results subroutine gathers read statistics: number of good reads, number of no-reads, and so on. This is not required for operation. It is simply for demonstration purposes.

Execute String Commands (DMCC)

The string command feature provides a simple way to invoke DMCC commands from the PLC. The command format and command result format is exactly identical to that used for serial or Telnet DMCC operation.

This subroutine copies an example DMCC command (||>GET CAMERA.EXPOSURE) to the String Command block and then manages the string command handshake operation between the PLC and the reader to invoke the command and retrieve the command result. Any valid DMCC command may be invoked with this mechanism. Refer to the DataMan *Command Reference* document available through the Windows **Start** menu or the DataMan Setup Tool **Help** menu.

Execute SoftEvents

SoftEvents are used to invoke a predefined action. Each SoftEvent is essentially a virtual input signal. Each of the SoftEvent subroutines manages the handshake operation between the PLC and the reader to invoke the predefined action. The associated action is invoked when the *SoftEvent* bit toggles from 0 to 1. The subroutine then watches for the associated *SoftEventAck* bit from the reader which signals that the action is complete. For a description of handshaking, see section [Operation](#).

Note: The “Execute DMCC” and “Set Match String” SoftEvents make use of the Input Data block. The subroutine for these two events copies the relevant data into the User Data fields of the Input Data block and then invokes the User Data subroutine to transfer the data to the reader. The actual SoftEvent action is invoked only after the user data is transferred. The user data needs to be transferred before invoking either of these events.

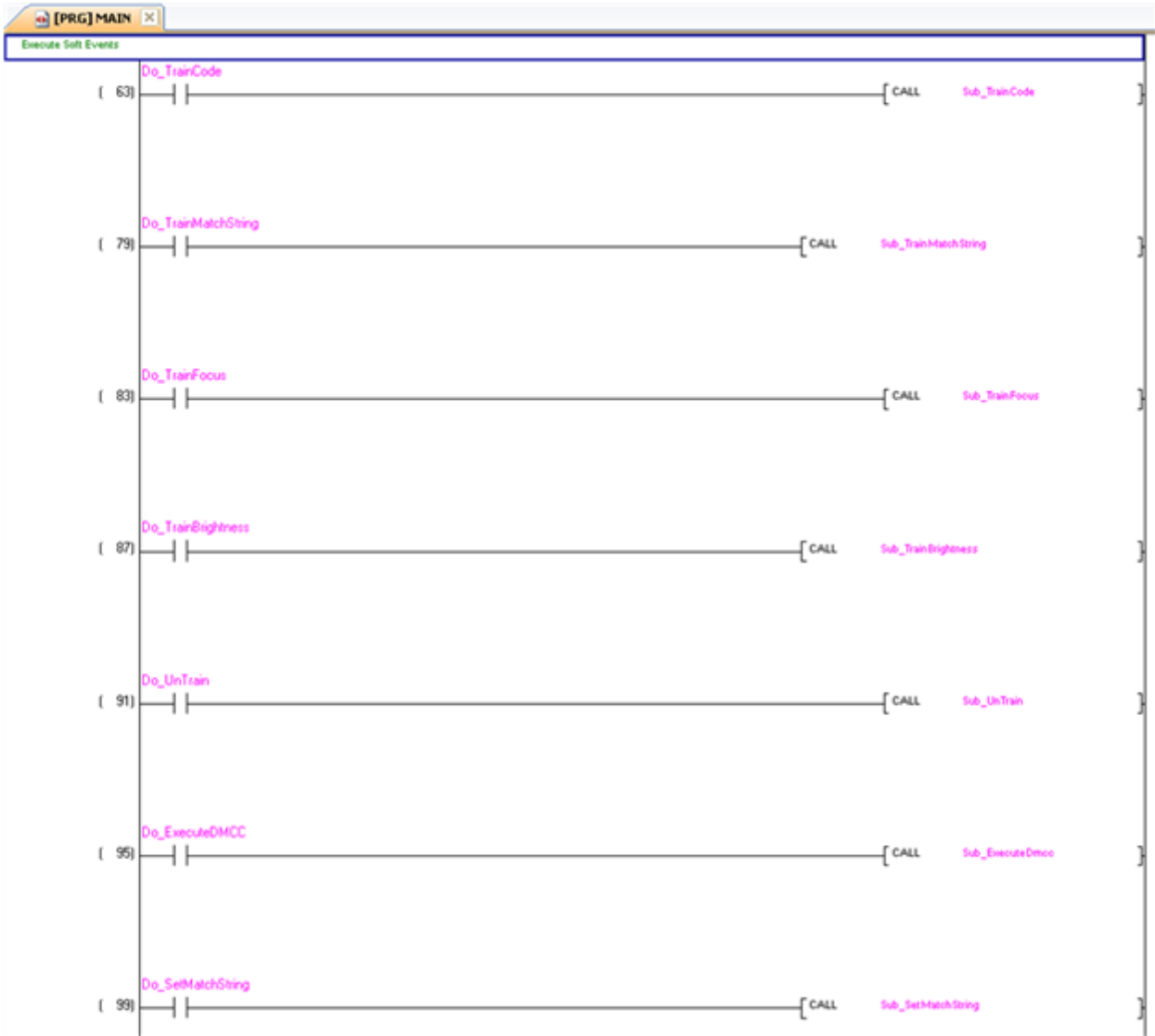

Note: The “Train Match String” SoftEvent only prepares the training mechanism. The actual training occurs on the next read operation. Therefore, a trigger must be issued following “Train Match String”.

ModbusTCP

Modbus is an application layer protocol. It provides client/server communication between devices connected to different types of buses or networks. Modbus is a request/response protocol, and its services are specified by using function codes.

Modbus TCP provides the Modbus protocol using TCP/IP. System port 502 is reserved for Modbus communication. It uses standard Ethernet hardware and software to exchange I/O data and diagnostics. DataMan provides Modbus TCP server functionality only.

By default, DataMan has the Modbus TCP protocol disabled. The protocol can be enabled in the Setup Tool, via DMCC, or by scanning a configuration code.

Note: If you have a wireless DataMan reader, see section [Industrial Protocols for the Wireless DataMan on page 116](#)

DMCC

The following commands can be used to enable/disable Modbus TCP. The commands can be issued via RS-232 or Telnet connection.

Note: Use a third party Telnet client such as PuTTY to communicate with your DataMan reader.

Enable:

```
||>SET MODBUSTCP.ENABLED ON
||>CONFIG.SAVE
||>REBOOT
```

Disable:

```
||>SET MODBUSTCP.ENABLED OFF
||>CONFIG.SAVE
||>REBOOT
```

Reader Configuration Code

Scanning the following reader configuration codes enables/disables Modbus TCP for your corded reader.

Note: You must reboot the device for the change to take effect.

Enable:



Disable:



Scanning the following reader configuration codes enables/disables Modbus TCP for your DataMan 8000 base station.

Note: You must reboot the device for the change to take effect.

Enable:



Disable:



Setup Tool

Modbus TCP can be enabled by checking **Enabled** on the Industrial Protocols pane's Modbus TCP tab. Make sure to save the new selection by choosing "Save Settings" before disconnecting from the reader.

Note: You must reboot your reader for the new settings to take effect.

Modbus TCP Handler

Modbus TCP on DataMan is implemented as a server type device. All communication is initiated by the PLC in the form of read and write requests. The PLC acts as a client which actively sends read and write requests.

Getting Started

By default, Modbus TCP is not enabled on the DataMan reader. The protocol must be enabled and the protocol configuration parameters must be set to correctly interact with a PLC. Protocol configuration is accomplished via the DataMan Setup Tool.

In the Setup Tool's **Communications** application step's **Ethernet** tab, check **Modbus TCP** to enable this industrial protocol.

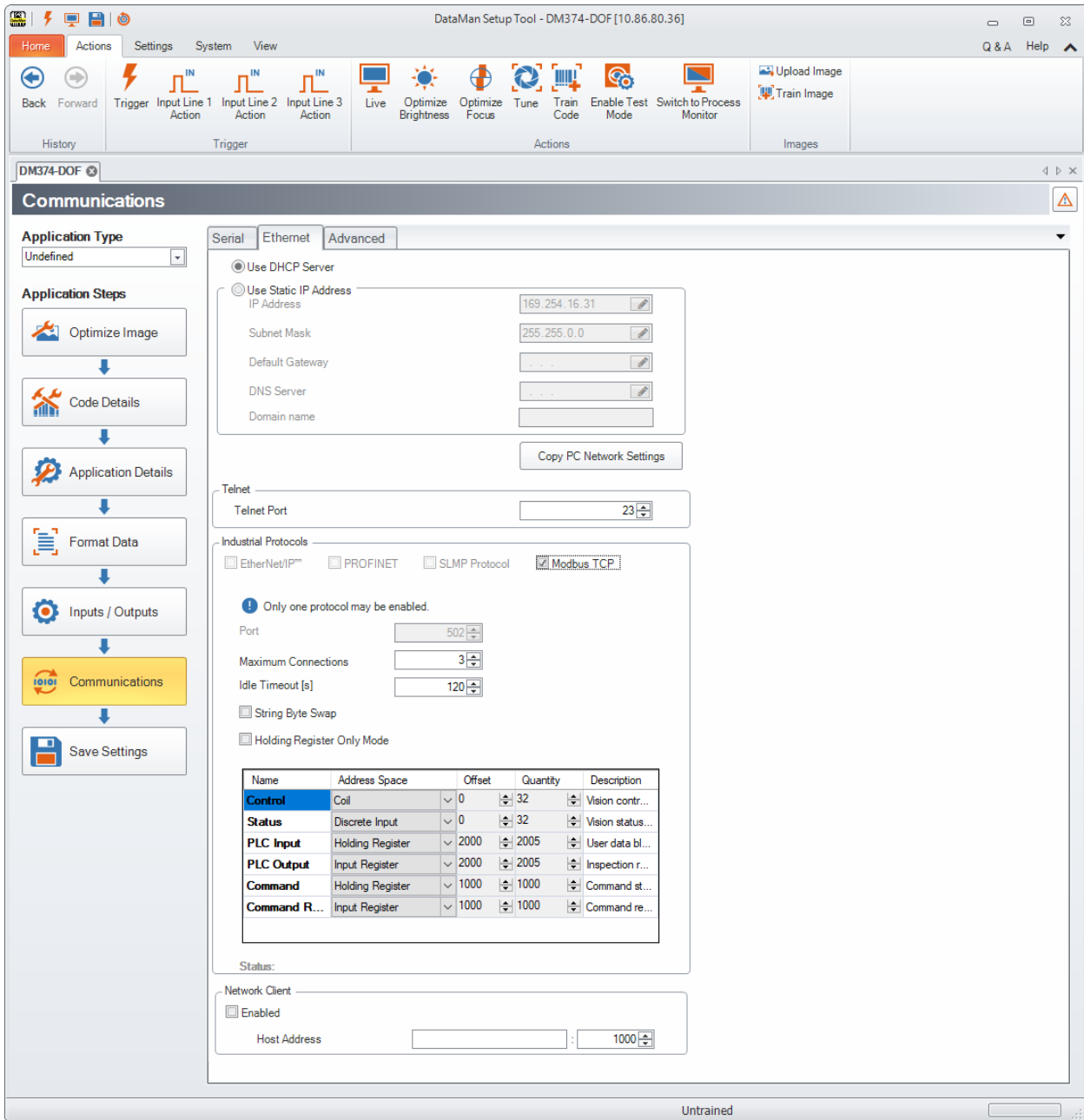

Make sure to save the new selection by clicking the **Save Settings** button in the upper toolbar before disconnecting from the reader.

Note: The new settings take effect only after the reader is rebooted.

Network Configuration

The network configuration defines all the information that the DataMan reader needs to establish a connection with a PLC. In most cases the default values may be used and no changes are need.

Name	Default	Range	Description
Host Port	502	Fixed	Port number where Modbus TCP can be accessed on this reader.

Max Connections	3	1-6	Maximum number of simultaneous Modbus TCP connections.
Idle Timeout (seconds)	120	1-3600	Timeout period after which the Modbus TCP connection will be closed. If no traffic is received on a Modbus TCP connection for this amount of time, the connection will automatically be closed.
String byte swap	False	True / False	String byte swap enable. If set to True, bytes within each register that forms a string will be swapped.
Holding Register Only Mode	False	True / False	Holding Register Only Mode enable. If set to True, all data blocks will be mapped to the Holding Register space.

Data Block Configuration

The data block configuration defines the data that will be exchanged between the DataMan reader and the PLC. Six data blocks are available. Each block has a predefined function.

DataMan only supports Modbus TCP server operation. For standard server operation, only two configuration options exist. By default the 'Control' and 'Status' data blocks are located in bit address space (Coil and Discrete Input). If needed, one or both of these data blocks may be redefined to exist in register address space (Holding Register and Input Register). All other data block configurations are fixed.

Standard Block Configuration

Block Name	Address Space	Offset	Schneider Form Addressing	Quantity
Control	Coil or Holding Register	0	000000 – 000031 400000 – 400001	32, if coil 2, if holding register
Status	Discrete Input or Input Register	0	100000 – 100031 300000 – 300001	32, if discrete input 2, if input register
PLC Input	Holding Register	2000	402000 – 404004	1 – 2005
PLC Output	Input Register	2000	302000 – 304004	1 - 2005
Command String	Holding Register	1000	401000 – 401999	1 - 1000
Command String Result	Input Register	1000	301000 – 301999	1 - 1000

Note: The 6 digit 0-based Schneider representation is used here.

DataMan also supports an alternate block configuration. A number of PLCs can only access the ModbusTCP 'Holding Register' address space. The alternate 'Holding Register Only' configuration exists to accommodate these PLCs. In this alternate configuration, all reader input and output data is mapped to the ModbusTCP 'Holding Register' address space. To enable this alternate mode, perform one of the following options:

- Check the "Holding Register Only" box on the ModbusTCP configuration screen.
- Use the DMCC, which switches on or off the alternate mode (Holding Register Only mode).

Enable:

```
||>SET MODBUSTCP-HOLDING-ONLY ON
```

Disable:

```
||>SET MODBUSTCP-HOLDING-ONLY OFF
```

- scan the Reader Programming Codes
 - for the wireless reader



- for the corded reader



Holding Register Only” Block Configuration

Block Name	Address Space	Offset	Schneider Form Addressing	Quantity
Control	Holding Register	0	400000 – 400001	2
Status	Holding Register	5000	405000 – 405001	2
PLC Input	Holding Register	2000	402000 – 404004	1 – 2005
PLC Output	Holding Register	7000	407000 – 409004	1 – 2005
Command String	Holding Register	1000	401000 – 401999	1 – 1000
Command String Result	Holding Register	6000	406000 – 406999	1 – 1000

Note: The 6 digit 0-based Schneider representation is used here.

Interface

This section describes the interface to the DataMan reader as seen by the PLC via Modbus TCP. The interface model consists of 6 data blocks grouped in 3 logical pairs:

- Control and Status
- Input Data and Output Data
- String Command and String Response

Control Block

The Control block contains bit type data. This block consists of the control signals sent from the PLC to the reader. It is used by the PLC to initiate actions and acknowledge certain data transfers.

Bit 7	Bit 6	Bit 5	Bit 4	Bit 3	Bit 2	Bit 1	Bit 0
Reserved				Results Ack	Buffer Results Enable	Trigger	Trigger Enable

Bit 15	Bit 14	Bit 13	Bit 12	Bit 11	Bit 10	Bit 9	Bit 8
Reserved							
Bit 23	Bit 22	Bit 21	Bit 20	Bit 19	Bit 18	Bit 17	Bit 16
Reserved						Initiate String Cmd	Set User Data
Bit 31	Bit 30	Bit 29	Bit 28	Bit 27	Bit 26	Bit 25	Bit 24
SoftEvent 7	SoftEvent 6	SoftEvent 5	SoftEvent 4	SoftEvent 3	SoftEvent 2	SoftEvent 1	SoftEvent 0

Control Block Field Descriptions

Bit	Name	Description
0	Trigger Enable	This field is set to enable triggering via the <i>Trigger</i> bit. Clear this field to disable the network triggering mechanism.
1	Trigger	Setting this bit triggers an acquisition. Note that the <i>Trigger Ready</i> bit must be set high before triggering an acquisition.
2	Buffer Results Enable	When this bit is set, each read result (<i>ResultID</i> , <i>ResultCode</i> , <i>ResultLength</i> and <i>ResultData</i> fields) will be held in the <i>Output Block</i> until it is acknowledged. Once acknowledged, the next set of read results will be made available from the buffer. If new read results arrive before the earlier set is acknowledged the new set will be queued in the reader's buffer. Up to 6 read results can be held in the reader's buffer. Refer to section Operation for a description of the acknowledgement handshake sequence.
3	ResultsAck	Set by the PLC to acknowledge that it has received the latest results (<i>ResultID</i> , <i>ResultCode</i> , <i>ResultLength</i> and <i>ResultData</i> fields). When the reader sees this bit transition from 0 to 1 it clears the <i>ResultsAvailable</i> bit. This forms a logical handshake between the PLC and reader. If result buffering is enabled, the acknowledgement will cause the next set of queued results to be moved from the buffer. See section Operation for a description of the acknowledgement handshake sequence.
4-15	Reserved	Future use
16	SetUserData	Set by the PLC to signal that new <i>UserData</i> is available. After reading the new <i>UserData</i> the reader sets <i>SetUserDataAck</i> to signal that the transfer is complete. This forms a logical handshake between the PLC and reader.
17	Initiate StringCmd	Set by the PLC to signal that a new <i>StringCommand</i> is available. After processing the command, the reader sets <i>StringCmdAck</i> to signal that the command result is available. This forms a logical handshake between the PLC and reader.
18-23	Reserved	Future use
24-31	SoftEvents	Bits act as virtual discrete inputs. When a bit transitions from 0 to 1 the associated action is executed. After executing the action the reader sets the corresponding <i>SoftEventAck</i> to signal that the action is complete. This forms a logical handshake between the PLC and reader. Bit0: Train code Bit1: Train match string Bit2: Train focus Bit3: Train brightness Bit4: Un-Train Bit5: Reserved (future use) Bit6: Execute DMCC command Bit7: Set match string

Status Block

The status block contains bit type data. This block consists of the status signals sent from the reader to the PLC. It is used by the reader to signal status and handshake certain data transfers.

Bit 7	Bit 6	Bit 5	Bit 4	Bit 3	Bit 2	Bit 1	Bit 0
-------	-------	-------	-------	-------	-------	-------	-------

Reserved				Missed Acq	Acquiring	Trigger Ack	Trigger Ready
Bit 15	Bit 14	Bit 13	Bit 12	Bit 11	Bit 10	Bit 9	Bit 8
General Fault	Reserved			Results Available	Results Buffer Overrun	Decode Complete Toggle	Decoding
Bit 23	Bit 22	Bit 21	Bit 20	Bit 19	Bit 18	Bit 17	Bit 16
Reserved						String Cmd Ack	Set User Data Ack
Bit 31	Bit 30	Bit 29	Bit 28	Bit 27	Bit 26	Bit 25	Bit 24
SoftEvent Ack 7	SoftEvent Ack 6	SoftEvent Ack 5	SoftEvent Ack 4	SoftEvent Ack3	SoftEvent Ack 2	SoftEvent Ack 1	SoftEvent Ack 0

Status Block Field Descriptions

Bit	Name	Description
0	Trigger Ready	Indicates when the reader is ready to accept a new <i>Trigger</i> . The reader sets this bit when <i>TriggerEnable</i> has been set and the reader is ready to accept a new trigger.
1	TriggerAck	Indicates when the reader recognizes that <i>Trigger</i> has been set. This bit will remain set until the <i>Trigger</i> bit has been cleared.
2	Acquiring	Set to indicate that the reader is in the process of acquiring an image.
3	Missed Acq	Indicates that the reader missed a requested acquisition trigger. The bit is cleared when the next acquisition is issued.
4-7	Reserved	Future use
8	Decoding	Set to indicate that the reader is in the process of decoding an image.
9	Decode Complete Toggle	Indicates new result data is available. Bit toggles state (0 -> 1 or 1 -> 0) each time new result data becomes available.
10	Results Buffer Overrun	Set to indicate that the reader has discarded a set of read results because the PLC has not acknowledged the earlier results. Cleared when the next set of result data is successfully queued in the buffer. This bit only has meaning if result buffering is enabled.
11	Results Available	Set to indicate that new result data is available. Bit will remain set until acknowledged with <i>ResultsAck</i> even if additional new read results become available.
12-14	Reserved	Future use
15	General Fault	Set to indicate that an Ethernet communications fault has occurred. Currently only used by SoftEvent operations. Bit will remain set until the next successful SoftEvent or until <i>TriggerEnable</i> is set low and then high again.
16	Set User Data Ack	Set to indicate that the reader has received new <i>UserData</i> . Bit will remain set until the corresponding <i>SetUserData</i> bit is cleared. This forms a logical handshake between the PLC and reader.
17	String Cmd Ack	Set to indicate that the reader has completed processing the latest string command and that the command response is available. Bit will remain set until the corresponding <i>InitiateStringCmd</i> bit is cleared. This forms a logical handshake between the PLC and reader.
18-23	Reserved	Future use

24-31	SoftEvent Ack	Set to indicate that the reader has completed the SoftEvent action. Bit will remain set until the corresponding SoftEvent bit is cleared. This forms a logical handshake between the PLC and reader. Bit0: Ack train code Bit1: Ack train match string Bit2: Ack train focus Bit3: Ack train brightness Bit4: Ack untrain Bit5: Reserved (future use) Bit6: Ack Execute DMCC command Bit7: Ack set match string
-------	------------------	---

Input Data Block

The Input Data block is sent from the PLC to the reader. The block consists of user defined data that may be used as input to the acquisition/decode operation.

Word 0	Word 1	Word 2..N
Reserved	User Data Length	User Data

Input Data Block Field Descriptions

Word	Name	Description
0	Reserved	Future use
1	User Data Length	Number of bytes of valid data actually contained in the <i>UserData</i> field.
2..N	User Data	User defined data that may be used as an input to the acquisition/decode.

Output Data Block

The Output Data block is sent from the reader to the PLC. The block consists primarily of read result data.

Word 0	Word 1	Word 2	Word 3	Word 4	Word 5...n
Reserved	Trigger ID	Result ID	Result Code	Result Length	Result Data

Output Data Block Field Descriptions

Word	Name	Description
0	Reserved	Future use
1	Trigger ID	Trigger identifier. Identifier of the next trigger to be issued. Used to match issued triggers with result data that is received later. This same value will be returned as the <i>ResultID</i> of the corresponding read.
2	Result ID	Result identifier. This is the value of <i>TriggerID</i> when the corresponding trigger was issued. Used to match up triggers with corresponding result data.
3	Result Code	Indicates the success or failure of the read that produced this result set. Bit0: 1=Read, 0=No read Bit1: 1=Validated, 0=Not Validated Bit2: 1=Verified, 0=Not Verified Bit3: 1=Acquisition trigger overrun Bit4: 1=Acquisition buffer overrun Bit5-15: Reserved (future use)

4	Result Data Length	Number of bytes of valid data actually in the <i>ResultData</i> field.
5...n	Result Data	Result data from this acquisition/decode. Formatted as ASCII text with two characters per 16-bit register. No terminating null character.

String Command Block

The String Command block is sent from the PLC to the reader. The block is used to transport string based commands (DMCC) to the reader.

Note: Do not send string commands that change the reader configuration at the same time as reads are being triggered. Changing configuration during acquisition/decode can lead to unpredictable results.

Word 0	Word 1...n
Length	String Command

String Command Block Field Descriptions

Word	Name	Description
0	Length	Number of bytes of valid data in the <i>StringCommand</i> field.
1..N	String Command	ASCII text string containing the command to execute. No null termination required.

String Command Result Block

The String Command Result block is sent from the reader to the PLC. The block is used to transport the response from string based commands (DMCC) to the PLC.

Word 0	Word 1	Word 2..N
Result Code	Length	String Command Result

String Command Result Block Field Descriptions

Word	Name	Description
0	Result Code	Code value indicating the success or failure of the command. Refer to the Command Reference , available through the Windows Start menu or the DataMan Setup Tool Help menu, for specific values.
1	Length	Number of bytes of valid data in the <i>StringCommand</i> field.
2..N	String Command Result	ASCII text string containing the command to execute. No null termination required.

Operation

Modbus TCP is a request/response based protocol. All communications are originated from the PLC. The reader acts as server.

Requests

To initiate actions or control data transfer, the PLC changes the state of certain bits of the Control block and sends requests to the reader.

After each request, the reader will process changes in state of the bits in the Control block. Some state changes require additional communications with the PLC, such as writing updated acknowledge bit values or reading a new string command. These additional communications are handled automatically by the reader. Other state changes initiate activities such as triggering a read or executing a SoftEvent. The reader performs the requested action and later reports the results.

Typical Sequence Diagram

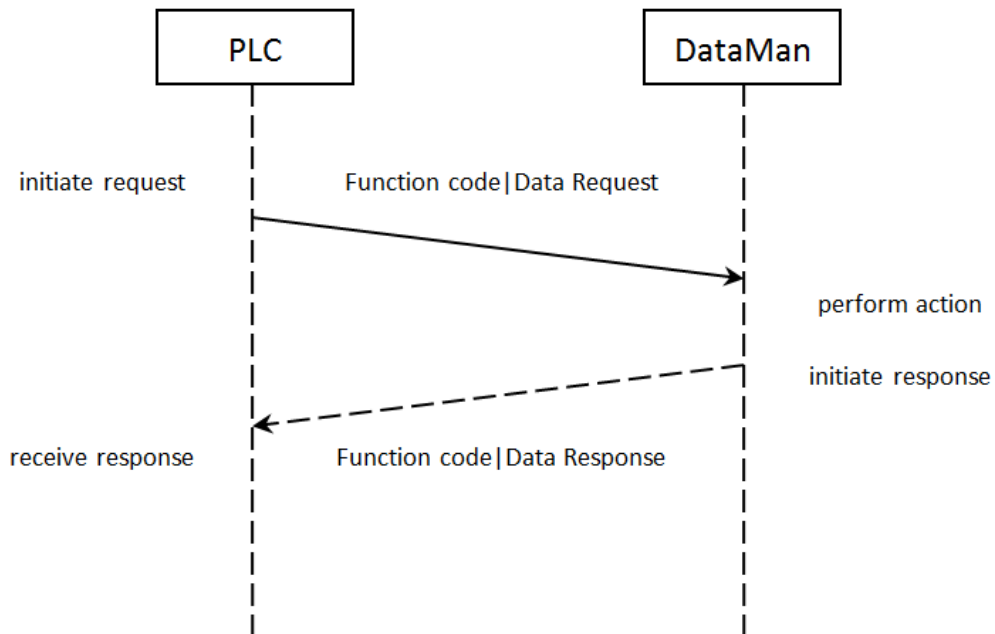

Handshaking

A number of actions are accomplished by means of a logical handshake between the reader and the PLC (triggering, transferring results, executing SoftEvents, string commands, and so on). This is done to ensure that both sides of a transaction know the state of the operation on the opposite side. Network transmission delays will always introduce a finite time delay in transfer data and signals. Without this handshaking, it is possible that one side of a transaction might not detect a signal state change on the other side. Any operation that has both an initiating signal and corresponding acknowledge signal will use this basic handshake procedure.

The procedure involves a four-way handshake.

1. Assert signal
2. Signal acknowledge
3. De-assert signal
4. De-assert acknowledge

The requesting device asserts the signal to request an action (set bit 0 -> 1). When the target device detects the signal and the requested operation has completed, it asserts the corresponding acknowledge (set bit 0 -> 1). When the requesting device detects the acknowledge, it de-asserts the original signal (1 -> 0). Finally, when the target device detects the original signal de-asserted, it de-asserts its acknowledge (bit 0 -> 1). To function correctly both sides must

see the complete assert/de-assert cycle (0 -> 1 and 1 -> 0). The requesting device should not initiate a subsequent request until the cycle completes.

Acquisition Sequence

DataMan can be triggered to acquire images by several methods. It can be done by setting the *Trigger* bit or issuing a trigger String Command. It can also be done via DMCC command (Telnet) or hardwired trigger signal. The *Trigger* bit method will be discussed here.

On startup, *TriggerEnable* will be False. It must be set to True to enable triggering via the *Trigger* bit. When the device is ready to accept triggers, the reader will set the *TriggerReady* bit to True.

While the *TriggerReady* bit is True, each time the reader detects the *Trigger* bit change from 0 -> 1, it will initiate a read. The *Trigger* bit should be held in the new state until that same state value is seen in the *TriggerAck* bit (this is a necessary handshake to guarantee that the trigger is seen by the reader).

During an acquisition, the *TriggerReady* bit will be cleared and the *Acquiring* bit will be set to True. When the acquisition is completed, the *Acquiring* bit will be cleared. When the device is ready to begin another image acquisition, the *TriggerReady* bit will again be set to True.

If results buffering is enabled, the reader will allow overlapped acquisition and decoding operations. *TriggerReady* will be set high after acquisition is complete but while decoding is still in process. This can be used to achieve faster overall trigger rates. If result buffering is not enabled, the *TriggerReady* bit will remain low until both the acquisition and decode operations have completed.

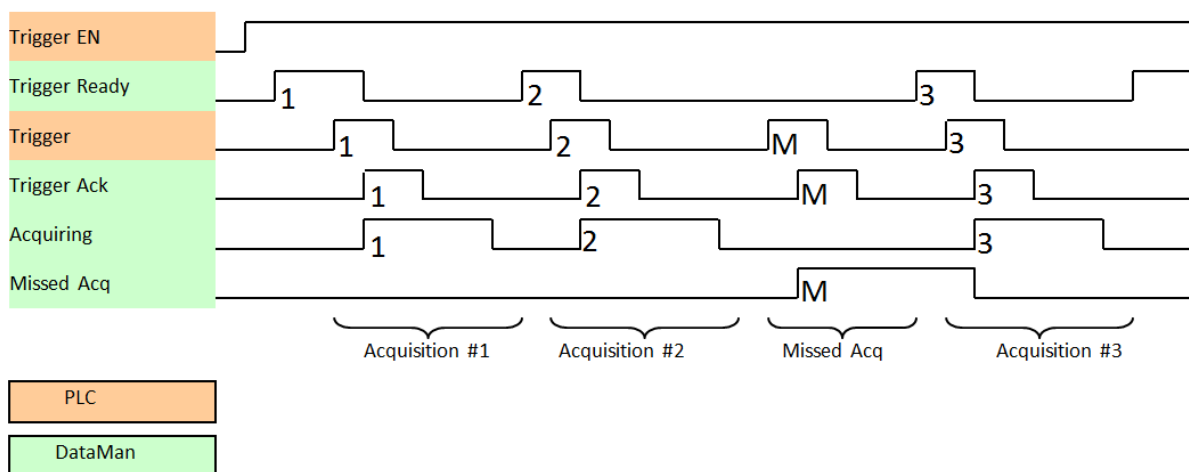

To force a reset of the trigger mechanism set the *TriggerEnable* to False until *TriggerReady* is also set to False. Then, *TriggerEnable* can be set to True to re-enable acquisition.

As a special case, an acquisition can be cancelled by clearing the *Trigger* signal before the read operation has completed. This allows for the cancellation of reads in Presentation and Manual mode if no code is in the field of view. To ensure that a read is not unintentionally cancelled, it is advised that the PLC hold the *Trigger* signal True until both *TriggerAck* and *ResultsAvailable* are True (or *DecodeComplete* toggles state).

Decode / Result Sequence

After an image is acquired, it is decoded. While being decoded, the *Decoding* bit is set. When the decode operation has completed, the *Decoding* bit is cleared. The *ResultsBufferEnable* determines how decode results are handled by the reader.

If *ResultsBufferEnable* is set to False, then the read results are immediately placed into the Output Data block, *ResultsAvailable* is set to True and *DecodeComplete* is toggled.

If *ResultsBufferEnable* is set to True, the new results are queued in a buffer and *DecodeComplete* is toggled. The earlier read results remain in the Output Data block until they are acknowledged by the PLC. After the acknowledgment

handshake, if there are more results in the queue, the next set of results will be placed in the Output Data block and *ResultsAvailable* is set to True.

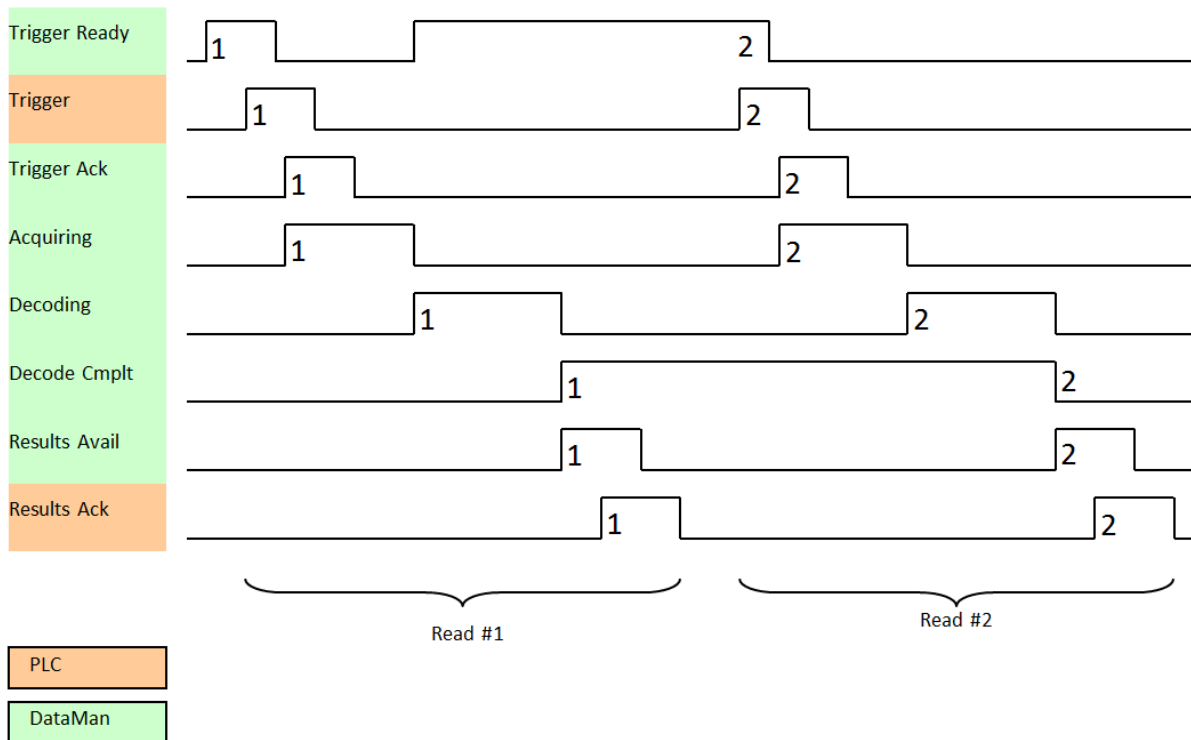

Results Buffering

There is an option to enable a queue for read results. If enabled, this allows a finite number of sets of result data to be queued up until the PLC has time to read them. This is useful to smooth out data flow if the PLC slows down for short periods of time.

Also, if result buffering is enabled the reader will allow overlapped acquisition and decode operations. Depending on the application this can be used to achieve faster overall trigger rates. See the Acquisition Sequence description for further details.

In general, if reads are occurring faster than results can be transferred to the PLC, some data will be lost. The primary difference between buffering or not buffering determines which results get discarded. If buffering is not enabled, the most recent results are kept and the earlier result (which was not read by the PLC quickly enough) is lost. The more recent result will overwrite the earlier result. If buffering is enabled (and the queue becomes full) the most recent results are discarded until room becomes available in the results queue.

Note: If the queue overflowed and then buffering is disabled, there will be a greater than 1 difference between the TriggerID and ResultID values. This difference represents the number of reads that occurred but could not be queued because the queue was full (number of lost reads equals TriggerID - ResultID - 1). After the next read, the ResultID value returns to the typical operating value of TriggerID - 1.

SoftEvents

SoftEvents act as virtual inputs. When the value of a *SoftEvent* bit changes from 0 to 1, the action associated with the event is executed. When the action completes, the corresponding *SoftEventAck* bit changes from 0 to 1 to signal completion.

The *SoftEvent* and *SoftEventAck* form a logical handshake. After *SoftEventAck* changes to 1, make sure that the original *SoftEvent* is set back to 0. When that occurs, *SoftEventAck* is automatically set back to 0.

Note: Do not execute SoftEvents that change the reader configuration at the same time that reads are being triggered. Changing configuration during acquisition/decode can lead to unpredictable results.

The “ExecuteDMCC” and “SetMatchString” SoftEvent actions require user supplied data. Make sure that this data is written to the *UserData* and *UserDataLength* area of the Input Data block prior to invoking the SoftEvent. Only one SoftEvent can be invoked at a time, because both of these SoftEvents depend on the *UserData*.

String Commands

The DataMan Modbus TCP Protocol implementation includes a String Command feature. This feature allows you to execute string-based DMCCs. The DMCC is sent to the reader through the String Command block. The DMCC result is returned through the String Command Result block. Initiating a command and notification of completion is accomplished by signaling bits in the Control and Status blocks.

To execute a DMCC, the command string is placed in the data field of the String Command block. The command string consists of standard ASCII text. The same command format is used for a serial (RS-232) or Telnet connection. The string does not need to be terminated with a null character. Instead, the length of the string, that is, the number of ASCII characters, is placed in the length field of the String Command block.

After executing the DMCC, the result string is returned in the String Command Result block. Similar to the original command, the result string consists of ASCII characters in the same format as returned through a serial or Telnet connection. Also, there is no terminating null character. Instead, the length of the result is returned in the Command String Result length field. The Command String Result block also contains a numeric result code. This allows you to determine the success or failure of the command without having to parse the text string. The values of the result code are defined in the DMCC documentation, available through the Windows **Start** menu or the Setup Tool **Help** menu.

General Fault Indicator

When a communication-related fault occurs, the “GeneralFault” bit changes from 0 to 1. The only fault conditions supported are SoftEvent operations. If a SoftEvent operation fails, the fault bit will be set. The fault bit will remain set until the next successful SoftEvent operation, or until *TriggerEnable* is set to 0 and then back to 1.

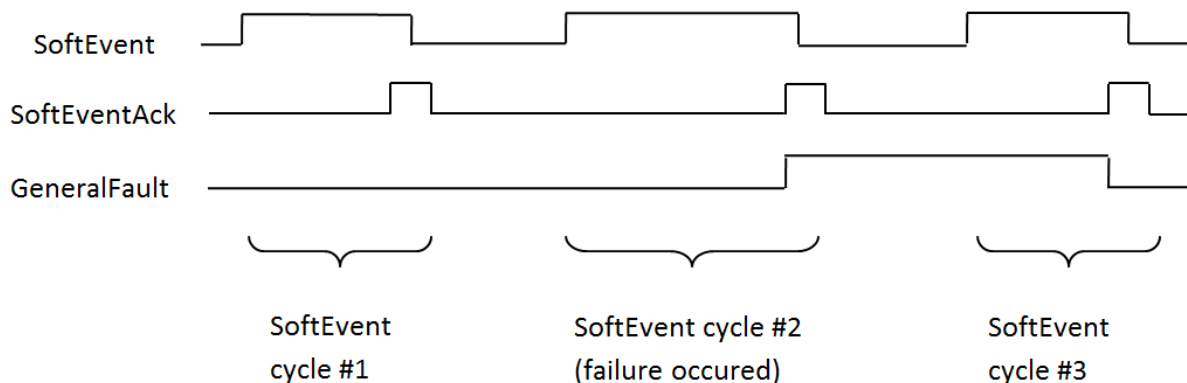

Examples

Included with the DataMan Setup Tool installer are two example PLC programs created with CoDeSys v2.3 software. These samples are designed and tested on a Wago 750-841 PLC. These programs demonstrate the DataMan ID readers' capabilities and proper operation. You can do the same operations by using more advanced features and efficient programming practices with Wago PLCs. The examples try to show different approaches in the techniques used for the communication to the DataMan reader and they are better for demonstration purposes.

Note: All examples are designed to work only if the “Control” datablock is mapped to the Coil space and the “Status” datablock is mapped to the Discrete Input space.

Application Layer Example

This sample realizes a generic data transfer between the DataMan reader and the PLC. Memory areas of the “Control”, “Status” and “Output Area” are cloned in the PLC and synchronized cyclically, or as needed. Each data area is synchronized with its own instance of “ETHERNETMODBUSMASTER_TCP”. This causes three TCP connections to be open simultaneously. Make sure that the Modbus TCP related setting “Maximum Connections” on the DataMan reader is set to at least 3 for this example to work.

Function

The example application demonstrates the following operations:

1. Transfer the 32-bit “Control” register data from the PLC to the reader.
2. Transfer the 32-bit “Status” register data from the reader to the PLC.
3. Transfer “Output Data” from the reader to the PLC.

All actions are started when there is a connection to the reader.

Transferring “Control” Register Data

All data gets transferred when there is a change in the local PLC data. The local PLC data can be manipulated in the visualization.

Note: No synchronization is implemented from the reader to the PLC, so the local PLC data can be incorrect after building up the connection or if another Modbus TCP client manipulates the Control register simultaneously. There is a timeout setting that can lead to a disconnect if you do not manipulate the “Control” register during this timeframe.

Transferring Status Register Data

All data gets transferred cyclically. The poll interval can be specified in the visualization.

Transferring Output Data

All data gets transferred cyclically. The poll interval can be specified in the visualization.

DataManControl Example

This sample shows in a sequential manner the steps to do to achieve one of the functions named in the following subsection. To outline this chronological sequence, “Sequential Function Chart” is used as programming language.

Function

The example application demonstrates the following operations:

1. Triggering a read
2. Getting read results
3. Executing string commands (DMCC)

4. Executing SoftEvent operations

- a. Train code
- b. Train match string
- c. Train focus
- d. Train brightness
- e. Untrain
- f. Execute DMCC
- g. Set match string

The “Main” program contains variables to invoke each of these operations. The operation is invoked by toggling the control bool directly or from the visualization (red=0, green=1) from 0 to 1. This will invoke the associated subroutine to perform the operation. When the operation 4 is complete, the subroutine will set the control bit back to 0.

Triggering a Read

The example provides a “Continuous Trigger”. As the name implies, enabling the “xTrigger” bit will invoke a continuous series of read operations. Once enabled, the “xTrigger” control bit will remain set until you disable it.

Primarily, the trigger subroutine manages the trigger handshake operation between the PLC and the reader. The control *Result Ack* and *Trigger* bits are reset, the *Trigger Enable* bit is set, the PLC waits for the corresponding *TriggerReady* status bit from the reader, and the control Trigger bit is set. Refer to a description of handshaking in section [Operation](#).

Getting Read Results

For this example the operation of triggering a read and getting read results was intentionally separated. This is to support the situation where the PLC is not the source of the read trigger. For example, the reader may be configured to use a hardware trigger. In such a case, only the get results subroutine would be needed.

Like the triggering subroutine, the get results subroutine manages the results handshake operation between the PLC and the reader. The routine waits for the *ResultsAvailable* status bit to become active, it copies the result data to internal storage, and then executes the *ResultsAck* handshake. Refer to a description of handshaking in section [Operation](#).

The read result consists of a *ResultCode*, **ResultLength**, and *ResultData*. Refer to section [Output Data Block Field Descriptions](#) for details of the *ResultCode* values. The *ResultLength* field indicates how many bytes of actual result data exist in the *ResultData* field. The subroutine converts this byte length to word length before copying the results to internal storage.

Execute String Commands (DMCC)

The string command feature provides a simple way to invoke DMCCs from the PLC. The command format and command result format is exactly identical to that used for serial or Telnet DMCC operation.

This subroutine copies an example DMCC (|>GET DEVICE.TYPE) to the String Command block and then manages the string command handshake operation between the PLC and the reader to invoke the command and retrieve the command result. Any valid DMCC command may be invoked with this mechanism. Refer to the DataMan **Command Reference** document available through the Windows **Start** menu or the Setup Tool **Help** menu.

Execute SoftEvents

SoftEvents are used to invoke a predefined action. Each SoftEvent is essentially a virtual input signal. Each of the SoftEvent subroutines manages the handshake operation between the PLC and the reader to invoke the predefined action. The associated action is invoked when the *SoftEvent* bit toggles from 0 to 1. The subroutine then watches for the associated *SoftEventAck* bit from the reader which signals that the action is complete. For a description of handshaking, see section [Operation](#).

Note: The “Execute DMCC” and “Set Match String” SoftEvents make use of the Input Data block. The subroutine for these two events copies the relevant data into the User Data fields of the Input Data block and then invokes the User Data subroutine to transfer the data to the reader. Only after the user data is transferred is the actual SoftEvent action invoked. It is required that the user data be transferred before invoking either of these events.

Note: The “Train Match String” SoftEvent only prepares the training mechanism. The actual training occurs on the next read operation. Therefore, a trigger must be issued following “Train Match String”.

Industrial Protocols for the Wireless DataMan

Special considerations must be taken into account when using any of the Industrial Ethernet protocols with DataMan wireless readers. Industrial protocol connections are established not between the PLC and the wireless device, but between the PLC and the DataMan base station.

The DataMan wireless reader may be, at times:

- powered down
- in hibernation mode
- physically out of range

Automatic power down and hibernation are features that preserve power and extend the time period between recharging.

The following sections detail the necessary configurations you have to set to communicate with the DataMan base station (through which information is routed to the DataMan wireless reader).

Protocol Operation

Because the wireless reader can become unavailable at times, the Industrial Ethernet protocols are actually run from the base station. The base station is directly wired to the Ethernet network and is online continuously (even when the reader is unavailable). In this way the Ethernet protocol operation is not disrupted when the reader is unavailable. This results in a few special considerations.

Ethernet Address

Because the Ethernet protocols are run from the base station, you must use the base station Ethernet address when configuring the protocol. For example, when configuring EtherNet/IP using the RSLogix5000 software package, you select the DM8000 reader but you must enter the IP address of the base station (not the reader). The PLC using the protocol must communicate with the base station.

PLC Triggering

Because the wireless reader can become unavailable at times, triggering from the PLC is not supported on wireless readers. The PLC will receive all read results triggered from the reader. Also, SoftEvents and DMCC commands are supported (when the reader is available).

SoftEvents

SoftEvents triggered from the PLC are supported. However, these events will fail if the reader is unavailable. Such a failure will be signaled by the 'General Fault' bit.

Note: Some operations assigned to SoftEvents are in general not supported on any handheld DataMan readers (for example, 'Train Code', 'Train Focus', 'Train Brightness'). Unsupported operations will also result in the 'General Fault' signal being set.

DMCC

DMCC commands issued from the PLC are supported. However, these events will fail if the reader is unavailable. Depending on which Industrial Ethernet protocol is in use, the failure will be signaled either with the 'General Fault'

signal or an error status return code. The new DMCC error return code '105' has been established to signal that the reader is unavailable.

Note: When issuing DMCC commands from the PLC to a wireless reader, do not change the DMCC response format (that is, do not issue the command 'COM.DMCC-RESPONSE'). Doing this may disable DMCC operation on the wireless reader. This command can be used on non-Industrial Ethernet connections such as Telnet.

Offline Buffering

When the wireless reader is physically out of range of the base station, it will automatically buffer all reads. Buffer capacity varies according to a number of factors. However, typically several hundred reads can be stored. These buffered reads are also preserved if the reader enters hibernation (sleep mode). When the reader is brought back into range of the base station the buffered reads will automatically be downloaded.

If this offline buffering situation is anticipated in the user application, then Industrial Ethernet protocol buffering should also be enabled. Protocol buffering will allow a PLC to control the rate that read results are returned to the PLC. This prevents the PLC from becoming overwhelmed by a rapid flow of read results. Refer to the specific Industrial Protocol section of this document for details of enabling and utilizing protocol buffering.

Note: The base station can buffer up to 500 results.

Status of Industrial Protocols

The Status field of the industrial protocols (in Setup Tool, under Industrial Protocols tab) displays the last logged message of the status dialog. The message will remain displayed until another message is logged. If no industrial protocol is enabled, the status field remains blank.

Status messages vary by protocol, and some protocols do not log any messages. See the table below for a summary of messages for protocols that display them:

Protocol/Reader	Message	Description
Wi-Fi readers	Industrial ethernet protocols shutdown	Displayed if no protocol is running
	Proxy %s connection opening	Opening connection to Wi-Fi reader, s == connection type ("Command", "Result", or "User DMCC")
	Proxy %s open	Connection open, s == connection type ("Command", "Result", or "User DMCC")
	Proxy %s not open	failed to open connection, s == connection type ("Command", "Result", or "User DMCC")
	Proxy %s closed	connection has been closed, s == connection type ("Command", "Result", or "User DMCC")
Modbus TCP	Modbus TCP starting...	Protocol starting
	Modbus TCP: Server Setup Failed	Failed to start server
	Modbus TCP running	Protocol running
	Modbus TCP: Add block %s failed	Data block configuration error
	Modbus TCP control block %s	Status of ModbusTCP data block, s == "info" or "error"

Protocol/Reader	Message	Description
SLMP Protocol	Opening SLMP scanner connection %s:%x	starting SLMP connection, s==IP address, x==port number
	SLMP scanner connection established %s:%x	SLMP connection established, s==IP address, x==port number
	SLMP scanner connection %s:%x rejected	PLC has rejected the connection, s==IP address, x==port number
	SLMP scanner connection %s:%x faulted	Miscellaneous connection fault has occurred, s==IP address, x==port number
	SLMP scanner poll rate set too low	Configured SLMP poll rate is set too low
	SLMP scanner connection normal %s:%x	SLMP connection has been restored, s==IP address, x==port number
	SLMP Scanner control block %s	Status of SLMP data block, s == "info" or "error"
	SLMP Scanner failed transferring '%s' block	Comm error, failed to transfer a data block, s==block name

