

COGNEX®

AID 360

Quick Reference Guide

9/22/2015

Version 5.6.0

DATAMAN
ID Readers

1**Getting Started**

About AID360 • For More Information • AID 360 Accessories • AID 360 Systems

Page 4**2****Setting Up Your AID 360**

Reader Layout • SD Card Slot • Installing the Lens • Installing a Filter • External Light Mounting Brackets • Setting Focus • Field of View and Reading Distances • Dimensions • AID 360 Imager Specifications

Page 12**3****DataMan Software**

Installing DataMan Software and Connecting the Reader • Troubleshooting an Ethernet Connection • Industrial Protocols • Test Mode • Triggering • Multi-Reader Triggering • Tuning • Image Filtering • Training the Reader • Scripting • Package Detection Support

Page 53**4****Connections, Optics, and Lighting**

External Light Control • Power and I/O Cable • High-Speed Output Lines • High-Speed Output Wiring • Ethernet M12 to RJ45 Cable • Acquisition Triggering

Page 69**5****Compliance Information, Warnings and Notices**

Warnings and Notices • Compliance Statements • AID 360 Specifications

Page 77

About the AID 360 Readers

The AID 360 readers are high-performance, fixed-mount ID readers that among others offer the following advanced features:

- Highest Read Rates on 1-D and 2-D codes
- Most flexible optics and lighting
- Intelligent tuning and express setup



The AID 360 readers provide advanced Ethernet connectivity, support for serial RS-232 and discrete I/O, as well as advanced options for lighting and optics.

The AID 360 readers are packaged in a rugged, IP65-rated housing, and they provide numerous ease-of-use features, including one button to trigger and one to start tuning.

For More Information...

This document provides basic information about how to configure and use AID 360 readers. Additional information is available through the Windows **Start** menu or the Setup Tool **Help** menu after you install the DataMan software on your PC:

 **DataMan Communications & Programming Guide** shows how to integrate your DataMan reader with your automation software and factory network.

Cognex->DataMan Software v x.x->Documentation->Communications & Programming

 **DataMan Reader Configuration Codes** provides printable 2-D codes that you can use to configure the DataMan reader.

Cognex->DataMan Software v x.x->Documentation->English->Reader Configuration Codes

 **DataMan Fixed Mount Readers Reference** is a complete online hardware reference for the DataMan fixed-mount ID readers.

Cognex->DataMan Software v x.x->Documentation->English->AID360 ->Fixed Mount Reference Manual

 **DataMan Questions and Answers** provides context-sensitive information. You can view this help inside the Setup Tool or as a stand-alone help file.

Cognex->DataMan Software v x.x->Documentation->DM300 Series->Questions and Answers

 **Release Notes** list detailed system requirements and additional information about this DataMan software release.

Cognex->DataMan Software v x.x->Documentation->DataMan v x.y.z Release Notes

AID 360 Accessories

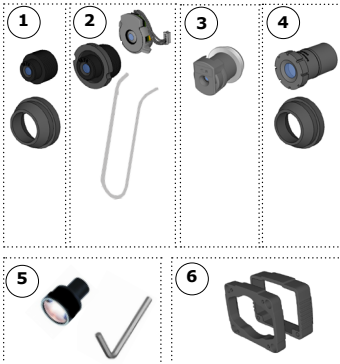

M12/S-MOUNT LENS OPTIONS

- ① 10.3 mm M12 lens with locking (DM300-LENS-10)
10.3 mm IR M12 lens with locking (DM300-LENS-10-IR)
- ② Liquid lens module and pre-focused 10.3 mm M12 lens with wrench (DM300-LENS-10LL)
Liquid lens module and pre-focused 10.3 mm IR M12 lens with wrench (DM300-LENS-10LL-IR)
- ③ 19 mm liquid lens module (DM300-LENS-19LL)

- ④ 16 mm M12 lens with locking (DM300-LENS-16)
- ⑤ 25 mm M12 lens with lens spacer and hex wrench (DM300-LENS-25) (also requires item ⑥)
- ⑥ Extension kit (DM300-EXT)

LENS COVERS

- ⑦ Clear lens cover (DM300-CLCOV)
- ⑧ Clear lens cover with white LED illumination (DM300-CLCOV-WHI)
- ⑨ Diffuse lens cover with red LED illumination (DM300-DLCOV-RE)
- ⑩ Diffuse lens cover with blue LED illumination (DM300-DLCOV-BL)

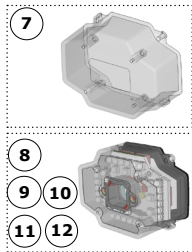

- ⑪ Diffuse lens cover with IR LED illumination (DM300-DLCOV-IR)
- ⑫ Polarizer lens cover with red LED illumination (DM300-PLCOV-RE)
- ⑬ Diffuse lens cover, red illumination (assembled), ESD safe (DM300-DLCOV-RE-ESD)
- ⑭ C-Mount cover for C-Mount lenses (DM300-CMCOV)
- ⑮ Short C-Mount cover for C-Mount lenses (DM300-CMCOV-SH)

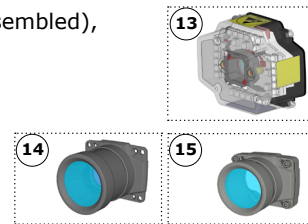

EXTERNAL LIGHTS (RED LED)

- ⑯ Ring light (CLRR-R7030G1CLR)
- ⑰ Back light (CLRB-F100100G1)
- ⑱ Coaxial (DOAL) light (CLRO-K5050G1)
- ⑲ Spot light (CLRS-P14G1)
- ⑳ Dark-field light (CLRD-D120G1)

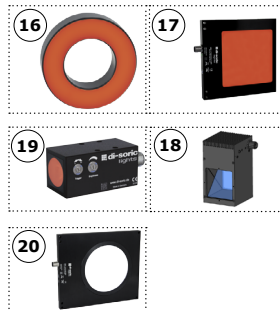

AID 360 Accessories (Continued)

LASER AIMERS

21 Laser aimer (DM300-AIMER-00)



HIGH POWER ILLUMINATIONS

22 23 24 25 26 27

28 29



22 Red narrow (DM30X-HPIA-625)

23 Red wide (DM30X-HPIA-625-W)

24 White narrow (DM30X-HPIA-WHI)

25 White wide (DM30X-HPIA-WHI-W)

26 Blue narrow (DM30X-HPIA-470)

27 Blue wide (DM30X-HPIA-470-W)

28 Infrared narrow (DM30X-HPIA-IR)

29 Infrared wide (DM30X-HPIA-IR-W)

30



30 DM500 C-Mount cover (DM500-CMTLC-000)

31



31 DM500 Lens cover extender (DM500-LNSEXT-000)

CABLES

32 Connection cable 24V, I/O, RS-232 (CCB-M12x12Fy-xx) (y straight/angled, xx specifies length) (layout on pg.72)



33 Power and I/O breakout cable, M12-12, 15m (CCB-PWRIO-15)

34 Connection cable 24V, I/O, RS-232 (CCBL-05-01) (layout on pg.73)

35 Connection cable RS-232 (CCB-M12xDB9Y-05)



36 Ethernet M12 to RJ45 cable (CCB-84901-y00x-xx) (y straight/angled, x-xx specifies length)



37 External light cable (CCB-M12x4MS-xxx) (xxx specifies length)



38 I/O extension cable, 5m straight (CKR-200-CBL-EXT)

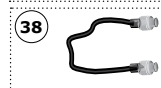

POWER SUPPLIES



39 24V power supply (ACC-24I)

40 24V power supply (PS-KIT-1)

AID 360 Accessories (Continued)

MOUNTING BRACKETS

41

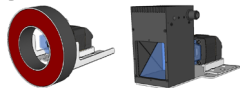

42



41 External light mounting brackets (DM300-ELMB-xx) (xx specifies light type) (may get used in combination with DM500-BRKT-000 if pivoting is required)

42 Universal Mounting Bracket (DM100-UBRK-000)

43

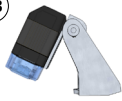

43 Pivot Mounting Bracket (DM100-PIVOTM-00)

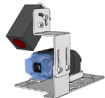
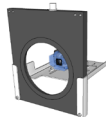

AID 360 Systems



Omni-directional 1-D Code Reading

1DMax+™ — Best-In-Class 1-D Reading

IDQuick™ — High-Speed 2-D Reading

2DMax+™ — for hard to read DPM and damaged 2-D codes

Resolution

	Omni-directional 1-D Code Reading	1DMax+™ — Best-In-Class 1-D Reading	IDQuick™ — High-Speed 2-D Reading	2DMax+™ — for hard to read DPM and damaged 2-D codes	Resolution
AID 300L (DMR-300L-00)		✓			800x600
AID 300X (DMR-300X-00)	✓	✓	✓	✓	800x600
AID 302L (DMR-302L-00)		✓			1280x1024
AID 302X (DMR-302X-00)	✓	✓	✓	✓	1280x1024
AID 303L (DMR-303L-00)		✓			1600x1200
AID 303X (DMR-303X-00)	✓	✓	✓	✓	1600x1200

Reader Layout

The following image shows the built-in lighting system of the AID 360 reader, underneath the plastic lighting cover.

NOTE: The image below shows the two different front covers: the cover with front-mounted filter and the flat cover with an internal filter.

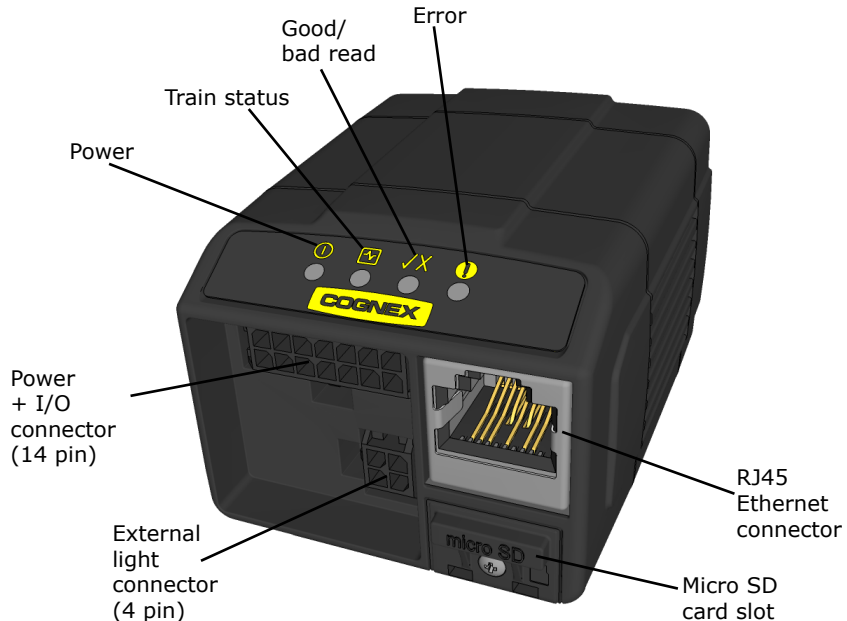
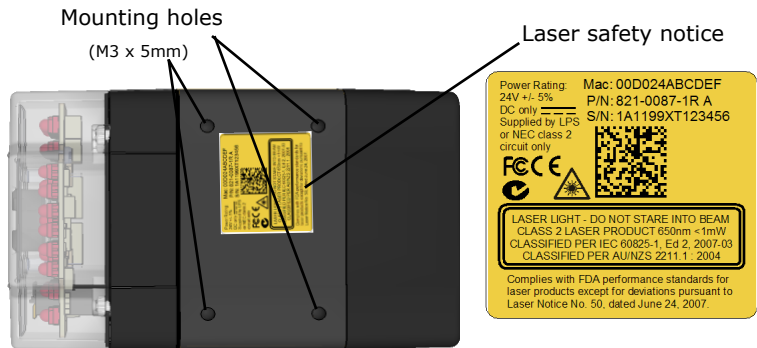
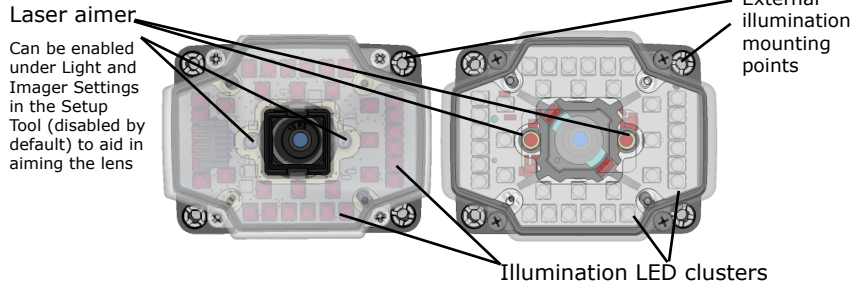

- Power: GREEN = Power ON
- Train status: GREEN = trained / YELLOW = untrained
- Good/bad read: GREEN = good read / RED = bad read
- Error: RED = error, check device log

SD Card Slot

The AID 360 readers are equipped with a Micro SD card interface which is located on the rear side of the reader, and comes with an SD card.

The Micro SD card can be installed to read and write system configuration and identity, so automatic backup and restore is done using the Micro SD card.

NOTE: The SD cards used with AID 360 must be FAT16 or FAT32 formatted SDHC cards.

Unscrew the small screw in the SD card cover to open the slot.

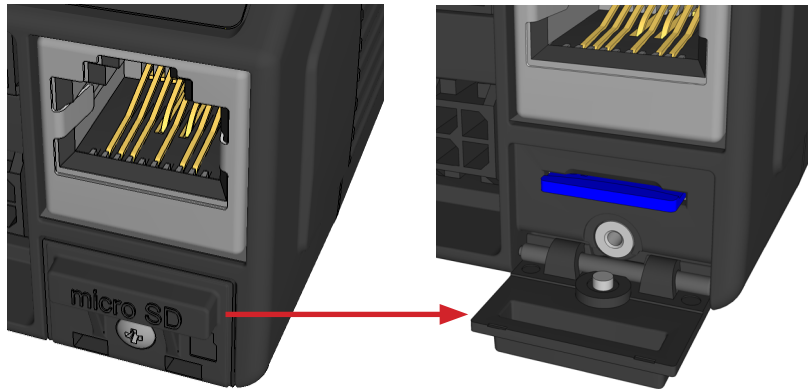

WARNING: Hot plugging the SD card is not supported and may lead to unexpected behavior. The SD card has to be present already at the boot phase.

Do not pull out the SD card during operation.



NOTE: If the SD card is not inserted, the Use SD Card for Backup feature is disabled and grayed out in Setup Tool.

SD Card Backup Settings

Use SD Card for Backup

⚠ No SD Card inserted to the device or the inserted SD Card is not suitable for Configuration Backup

If the SD card is inserted, but the file system is not supported, the error LED will be on and the system log will contain an error message.

Installing the Lens

You can choose between a variety of different S-Mount/M12 (including variable-focus liquid lens module) and C-Mount lens options to be installed on your AID 360 reader.



WARNING: Make sure that your reader is unpowered before installing the lens.

Installing M12 lens with Manual Focus

1 Remove lens plug.



2 Thread the lens into the reader.

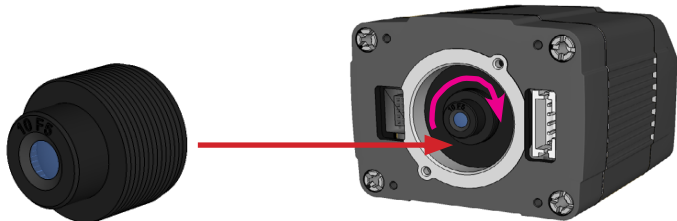

3 Press the rubber lens-locking cone into the reader.

While carefully avoiding rotating the lens, press the rubber lens cone into the reader until it snaps into place around the nose of the lens.

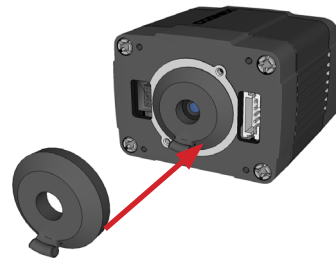

4 Place the reader at the desired working distance from focus target.

1. Connect the reader to the Setup Tool.
2. On the Results Display pane, check the Focus Feedback option and enable Live Display. For best results, adjust your camera settings to make sure you have a brightened and high contrast image.
3. Use the *DataMan Focus Target* template, available through the Windows Start menu or the Setup Tool Help menu, to align the edge of the reader body to the line marked with the target distance used in your application.
4. Adjust focus for maximum sharpness. Enhance image quality in the Setup Tool for better guidance.

Installing the Lens (Continued)

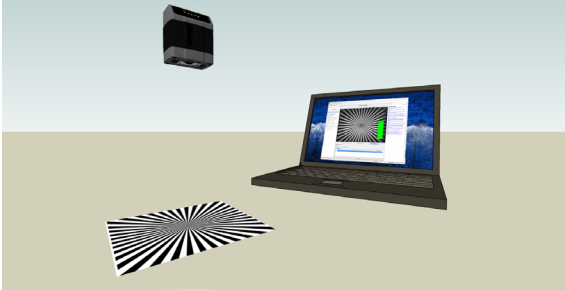

5 Tighten the lens.

After fixing the lens, verify focus position again, using the steps above.

6 Attach front cover.

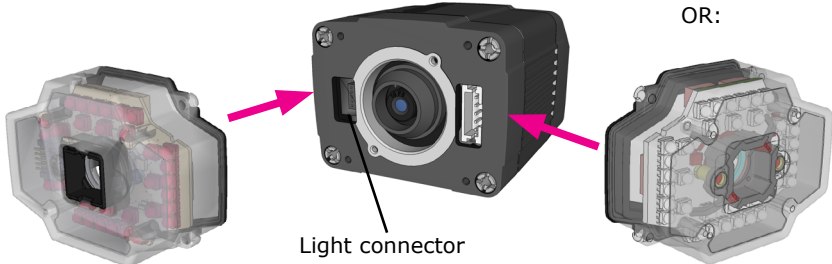

7 Insert and tighten screws.

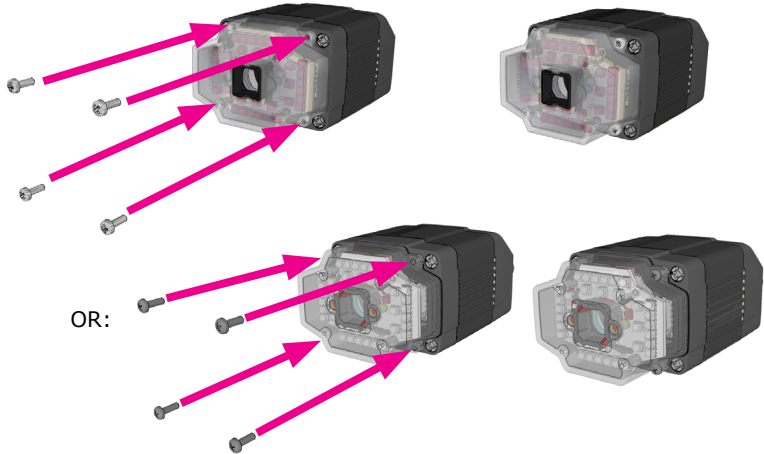

PHILLIPS PAN HEAD M2 X 6MM

⚠ Tighten in sequence. Torque limit: 9 Ncm (0.08 in-lbs).

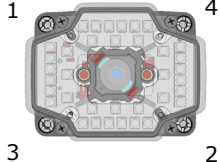

⚠ Remove the protection film applied to the front cover before usage!

Installing the Lens (Continued)

Installing a Liquid Lens

1 Remove the lens plug as described in Step 1 on page 16 above.

2 Thread the lens into the reader.

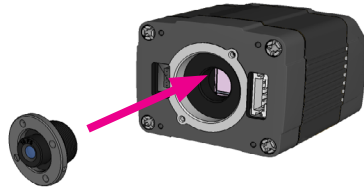

3 Tighten the locking ring.

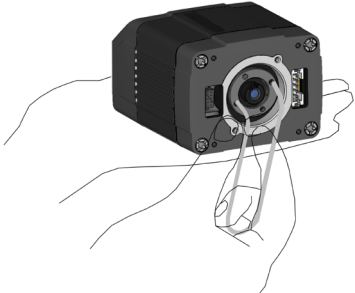

4 Connect the liquid lens cable to the reader.

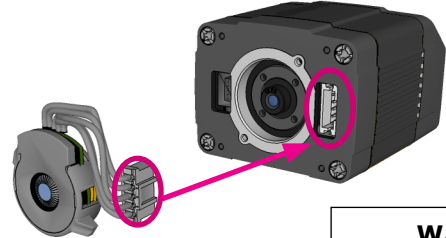

WARNING
 To avoid equipment damage, the cables must be routed as shown in the figure.

5 Snap the liquid lens module onto the nose of the lens, making sure that it lies flat.



Installing the Lens (Continued)

6 Attach front cover.

Light connector

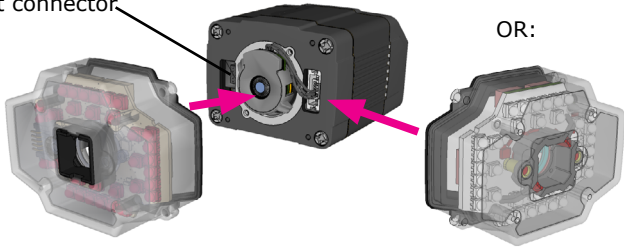

7 Insert and tighten screws.

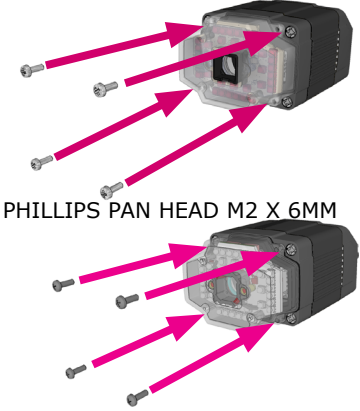

OR:



⚠ Tighten in sequence.
Torque limit: 9 Ncm
(0.08 in-lbs).



8 Place the reader at the desired working distance from focus target.

1. Connect the reader to the Setup Tool.
2. On the Results Display pane, check the Focus Feedback option and enable Live Display.
3. Use the *DataMan Focus Target* template, available through the Windows Start menu or the Setup Tool Help menu, to align the edge of the reader body to the line marked with the target distance used in your application.
4. Adjust focus for maximum sharpness. Enhance image quality in the Setup Tool for better guidance.

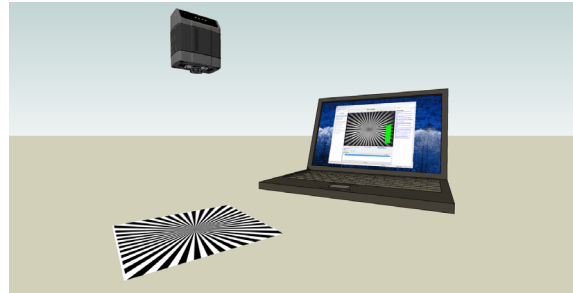

Installing the Lens (Continued)

Installing a C-Mount Lens

1 Remove the lens plug as described in Step 1 on page 16 above.

2 Thread the lens into the reader.



3 Place the reader at the desired working distance from focus target.

1. Connect the reader to the Setup Tool.
2. On the Results Display pane, check the Focus Feedback option and enable Live Display.
3. Use the *DataMan Focus Target* template, available through the Windows Start menu or the Setup Tool Help menu, to align the edge of the reader body to the line marked with the target distance used in your application.
4. Adjust focus for maximum sharpness. Enhance image quality in the Setup Tool for better guidance.

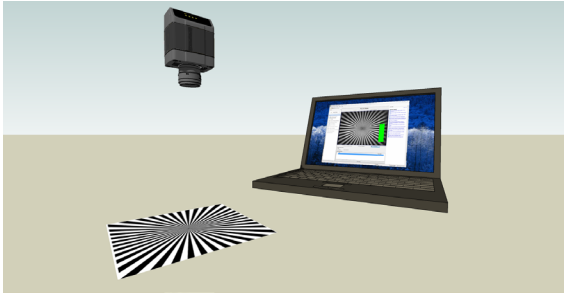



4 Attach C-Mount cover base.

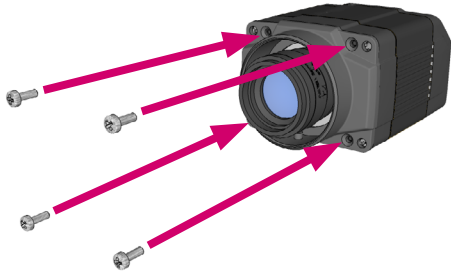

Installing the Lens (Continued)

5 Add screws to C-mount cover base.



 Tighten in sequence. Torque limit: 9 Ncm (0.8 in-lbs).

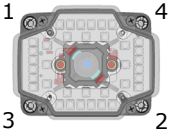

PHILLIPS PAN HEAD M2 X 6MM



6 Attach the front cover.

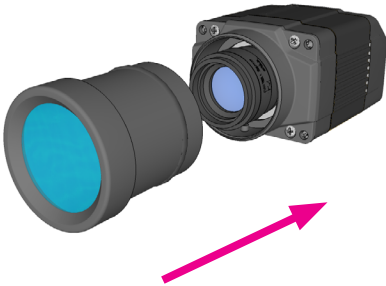

NOTE
Do not unscrew the front-most part of the nose of the cover to avoid risking the glass lens falling out.

Align the peg on the reader and the slot on the cover so that the cover locks in place.

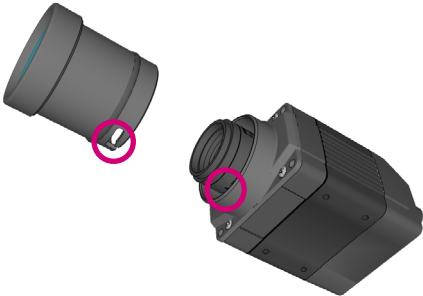

Installing a Filter (Old-Style Cover)

You can replace the window glass disk which is part of the light cover of your AID 360 reader with an optical filter. Observe the following constraints on the filter:

- Diameter (\varnothing)=12.5mm
- Thickness (t): 1.8mm<t<2mm

Perform the following steps:

1. Insert a flat head screwdriver with a tip of max. 2.2 mm on either the top or bottom side of the filter clip to release the clip on one side.

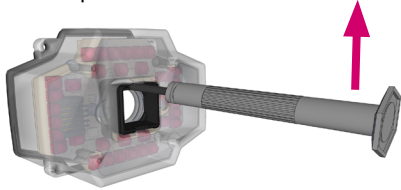
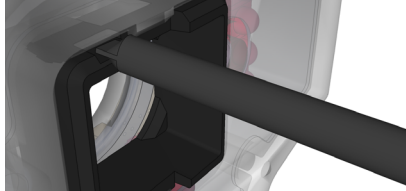

2. Insert the screw driver on the opposite side to fully release the clip, and remove the clip.

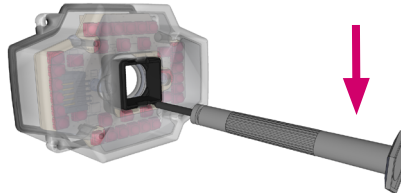
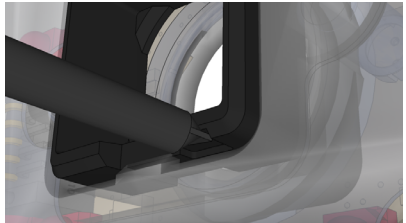

3. Remove the clip and remove the glass disk.

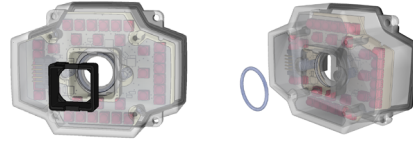

4. Insert the filter clip into the front window. Make sure that grooves in the clip are aligned with snap hooks in the front cover, and that the filter is centered on sealing.

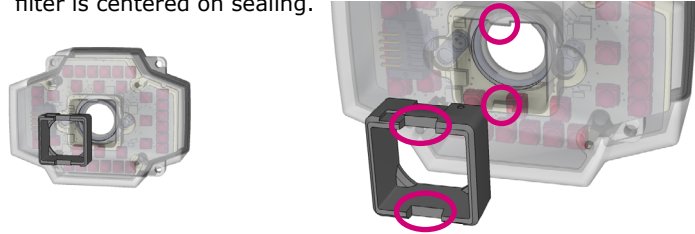

5. Press in the clip until you hear a clicking sound.

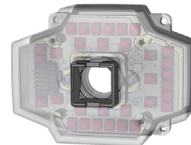

Installing a Filter (Flat-Front Cover)

Perform the following steps to install an optical filter in the front cover.

Observe the following constraints on the filter:

- Diameter (\varnothing): $12.3\text{mm} < \varnothing < 12.7\text{mm}$
- Thickness (t): $1.6\text{mm} < t < 2\text{mm}$

1. First, remove the front cover: unscrew the four M3 screws and take off the LED cover.

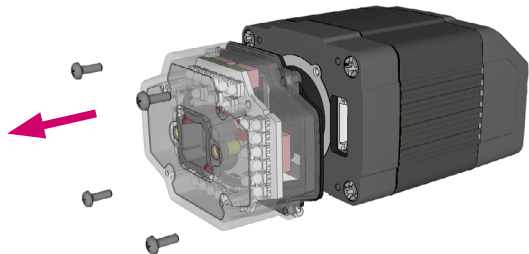

2. Take off the rubber seal, remove the two smaller screws, and remove the PCB.

 Use a T6 Torx screwdriver.

NOTE: Make sure that no electrostatic charges are applied to the PCB. (E.g. wear ESD shoes.)

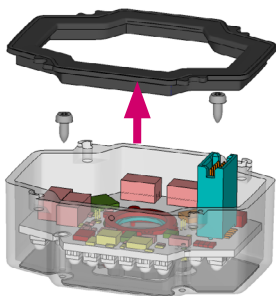

3. Working from the front of the PCB, press the legs of the filter holder gently together and pull off the clip.

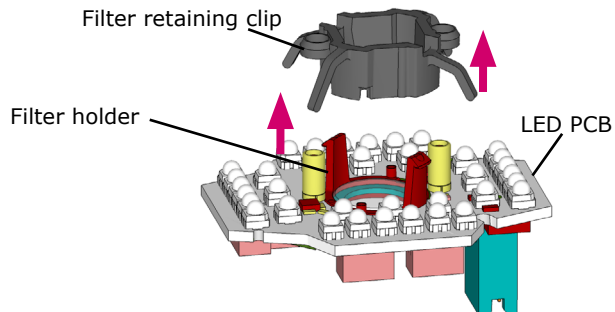

4. Insert first the filter glass, then the soft spacer (that was removed from its place between the filter holder and the filter retaining clip) into the filter holder. A pair of tweezers may be helpful.

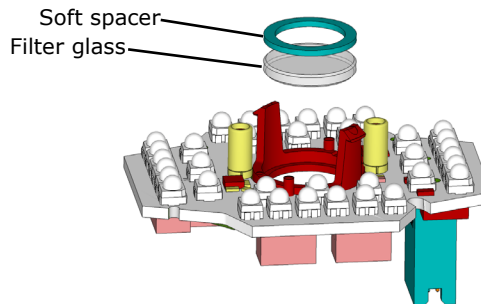

Installing a Filter (Flat-Front Cover - Continued)

5. Snap fit the filter retaining clip onto the legs of the filter holder. Ensure that the laser modules slide into the laser guides and the orientation pin fits into the filter retaining clip.

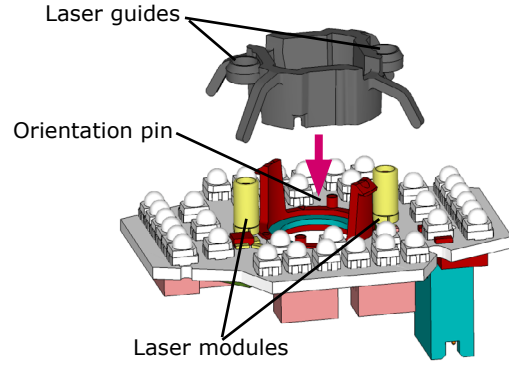

Check that the snap hooks are correctly positioned and fully engaged.

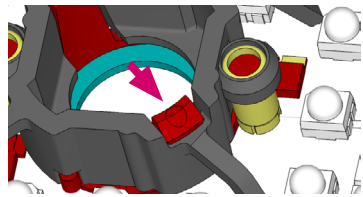

6. Insert the PCB with the filter retaining clip and the filter holder back into the front cover. Ensure that the hole in the PCB meets the orientation pin in the front cover.

Fix the PCB with two Torx 6 screws of size 2.0x5 mm.

⚠ Use a torque of 8-10Ncm (11-14 oz-in).

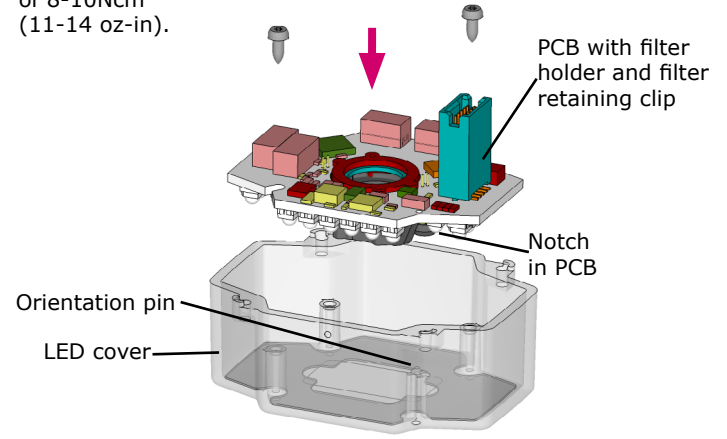

Installing a Filter (Flat-Front Cover - Continued)

7. Insert the rubber seal.

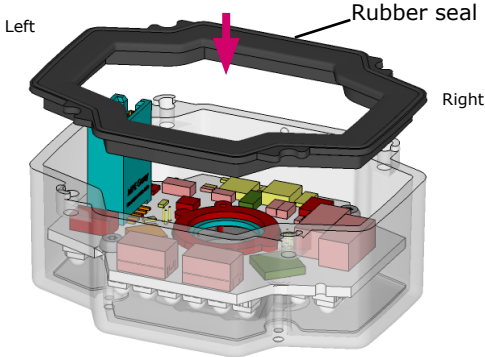

Note that the seal can only be installed in the correct orientation.

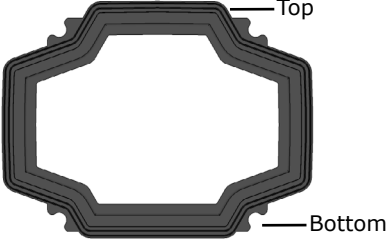

LED cover side
Optics mount side

8. Remount the front cover.
Observing the tightening sequence below, tighten all four screws to 9 Ncm using a torque wrench.

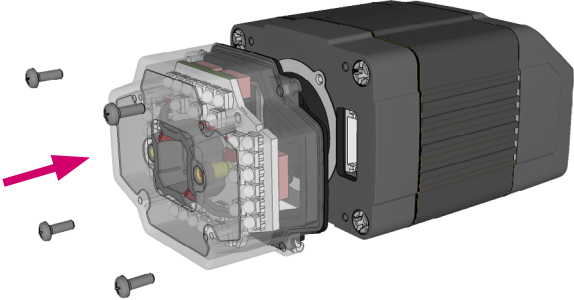

PHILLIPS PAN HEAD M2 X 6MM

⚠ Tighten in sequence.
Torque limit:
9 Ncm (0.08 in-lbs).

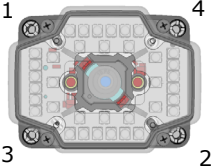

External Light Mounting Brackets

You can mount your reader using external light mounting brackets. The brackets are intended to mount any of the different lights to the reader. They can also be used to mount the reader (with lights attached) to your machine. Pivot mounting, as illustrated, is optional. Perform the following steps:

1. Mount your reader on the camera plate and attach the screws.

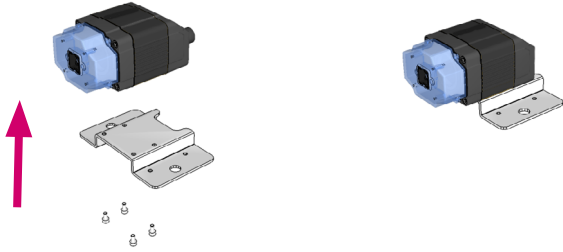

2. Mount your reader with the camera plate attached to any of the external light bracket adapters.

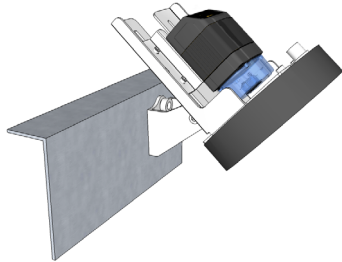

3. Choose one of the following light options:

- Using coaxial (DOAL) light

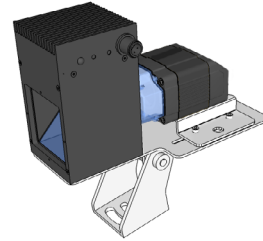

- Using ring light

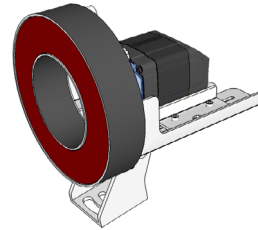

- Using dark field light

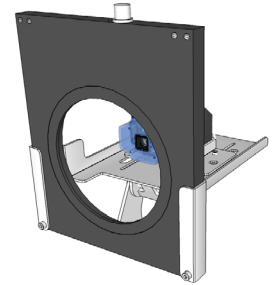

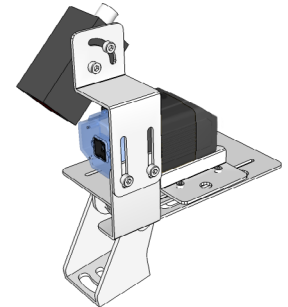

- Using spot light



Setting Focus

There is a range of reading distances available for different code sizes and focus positions. To set focus on your reader, use the following options depending on whether you use a liquid lens or a manual focus lens.

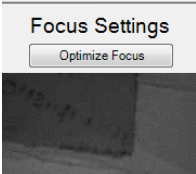
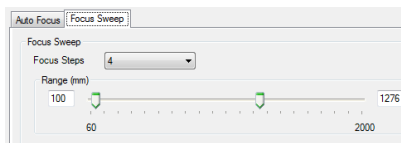
Liquid Lens	Manual Focus Lens
<p>Focus Feedback (Results Display)</p>  <p>The image shows a barcode with a green vertical bar on the right side. Below the image are two buttons: 'Focus Feedback' and 'Live Display'.</p>	<p>Focus Feedback (Results Display)</p>  <p>The image shows a barcode with a green vertical bar on the right side. Below the image are two buttons: 'Focus Feedback' and 'Live Display'.</p>
<p>Optimize Focus (Focus Settings)</p>  <p>The image shows a 'Focus Settings' dialog box with an 'Optimize Focus' button and a small image of a document.</p>	
<p>Focus Sweep (Focus Settings)</p>  <p>The image shows a 'Focus Sweep' settings dialog box. It has a 'Focus Steps' dropdown set to 4 and a 'Range (mm)' slider from 100 to 2000. There are also markers at 60 and 1276 on the slider.</p>	

For setting **Focus Sweep**, follow these guidelines:

- If your application has a consistent reading range, set the focus range to a limited depth of field with no steps (for example, set it to 20) or with limited steps (for example, set it to 2 steps between 0 and 30). This way you can achieve fast performance.
- If your application has a variety of code types and sizes, set the focus range to a wider depth of field with increased number of steps (for example, set it to 6 steps between 0 and 200). This way you can get better coverage.

Both **Optimize Focus** and the **Focus Feedback** use the same procedure for testing the current focus. They consider various subregions of the image.

For maximizing the performance of Optimize Focus and Focus Feedback, observe the following:

- Use a focus target (such as the one supplied with this Quick Reference Guide) that includes high-contrast features and is big enough that it fills at least a 100x100 pixel region in the center of the field of view at the desired working distance.
- Make sure the target is perfectly flat (avoid floppy pieces of paper).
- Make sure that the target is perfectly perpendicular to the optical axis of the reader.
- Make sure that the rest of the field of view (such as the part not covered by the focus target) does not contain any high-contrast features. For example, you would ideally fill the entire field of view with a white card or sheet of paper (no shadows), then position the focus target in the middle.
- The supplied focus target (120x120mm) is appropriate for typical working distances. If you are using a working distance such that the

Setting Focus (Continued)

target does not completely fill the image, make sure that there are no high-contrast features visible outside of the target (see previous bullet).

Notes:

If you are using the focus feedback indicator to adjust a manual focus lens, you must apply power to the reader before you remove the cover. If you remove the cover before applying power, the internal illumination will not function.

If you are using a Liquid Lens, make sure that the cover is mounted and connected before you apply power. If you attach or remove the front cover while the reader is powered, the focus settings will be lost.

Perform the following steps to use **Focus Feedback**:

1. Connect the reader to the Setup Tool.
2. On the Results Display pane, check the Focus Feedback option and enable Live Display.
3. The Focus Feedback column is displayed in colors ranging from red (bad focus) through yellow to green (sharp focus).



Position the reader in a way that the focus column becomes green. The maximum focus peak gets locked for better orientation. When the focus column is green, the lens is in focus and you will be able to decode the image.

Field of View and Reading Distances

The following maps show the field of view of the AID 360 readers. Reading distance values are also provided for 1-D and 2-D example code distances.

For the C-mount (or other non-Cognex) S-Mount lenses, the lens's focal length, focus setting, and aperture setting determine the field of view and reading distance.

Reading Distance and Field of View (AID 360 Readers with a 10.3 mm Lens)

This following map shows the field of view of the AID 360 readers with a 10.3 mm lens (with or without a liquid lens).

The FOV values are shown as follows:

- outer: AID302, AID303
- inner: AID300

The reading distances for the AID300 and AID302 readers are the same. AID303 features a higher resolution and more pixels in about the same sensor size.

The following table shows the Field of View widths in mm at various distances.

distances in mm	AID360	AID302/AID303
50	26	42
100	46	74
150	66	106
250	106	171
500	207	332

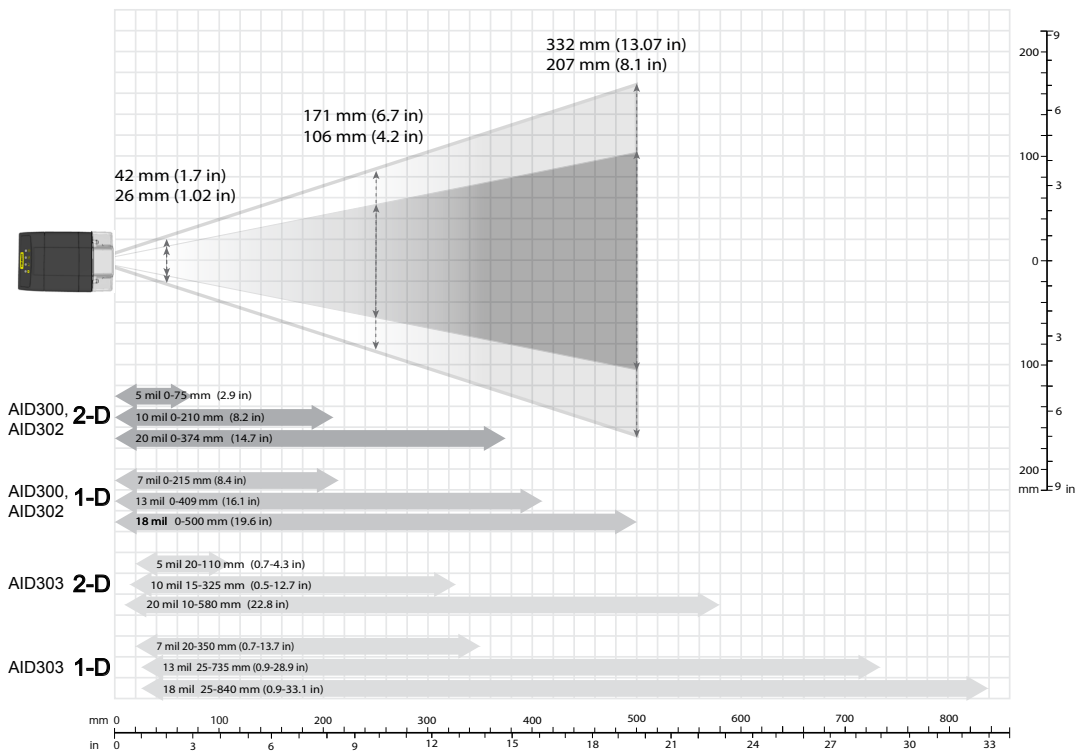

Reading Distance and Field of View (AID 360 Readers with a 16 mm Lens)

This following map shows the field of view of the AID 360 readers with a 16 mm lens.

The FOV values are shown as follows:

- outer: AID302, AID303
- inner: AID300

The reading distances for the AID300 and AID302 readers are the same. AID303 features a higher resolution and more pixels in about the same sensor size.

To make sure that your AID303 reader is able to decode at the minimum reading distances, use the reader in combination with the extension kit or without the front cover.

The following table shows the Field of View widths in mm at various distances.

distances in mm	AID360	AID302/ AID303
50	13	20
100	25	40
150	38	60
250	63	101
500	125	202

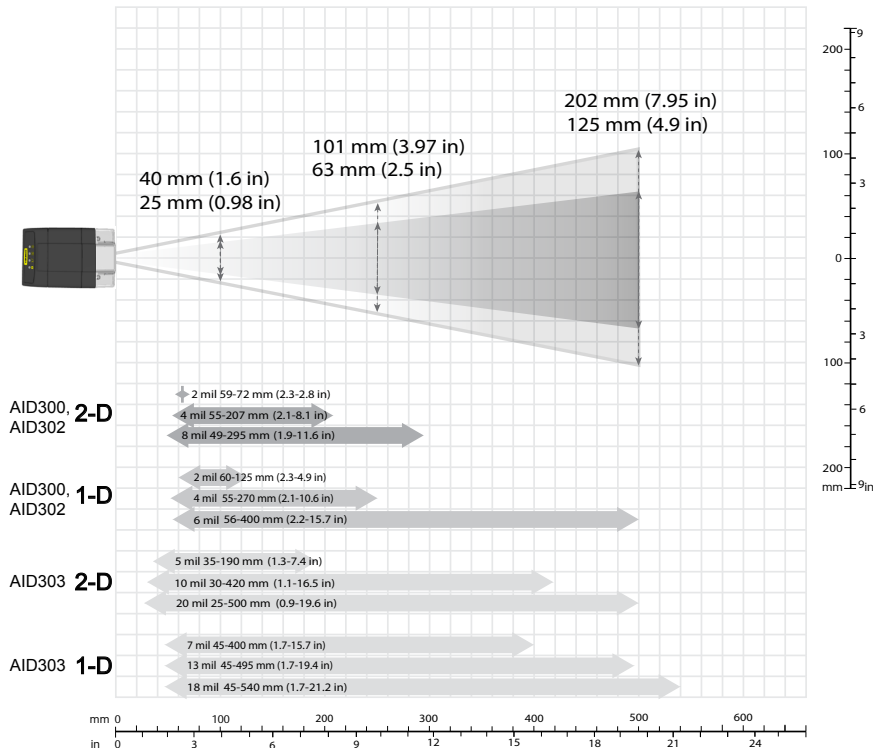

Reading Distance and Field of View (AID 360 Readers with a 19 mm Liquid Lens)

This following map shows the field of view of the AID 360 readers with a 19 mm liquid lens.

The FOV values are shown as follows:

- outer: AID302, AID303
- inner: AID300

The reading distances for the AID300 and AID302 readers are the same. AID303 features a higher resolution and more pixels in about the same sensor size.

The following table shows the Field of View widths in mm at various distances.

distances in mm	AID360	AID302/AID303
50	11	17
100	22	34
150	33	52
250	56	86
500	111	172

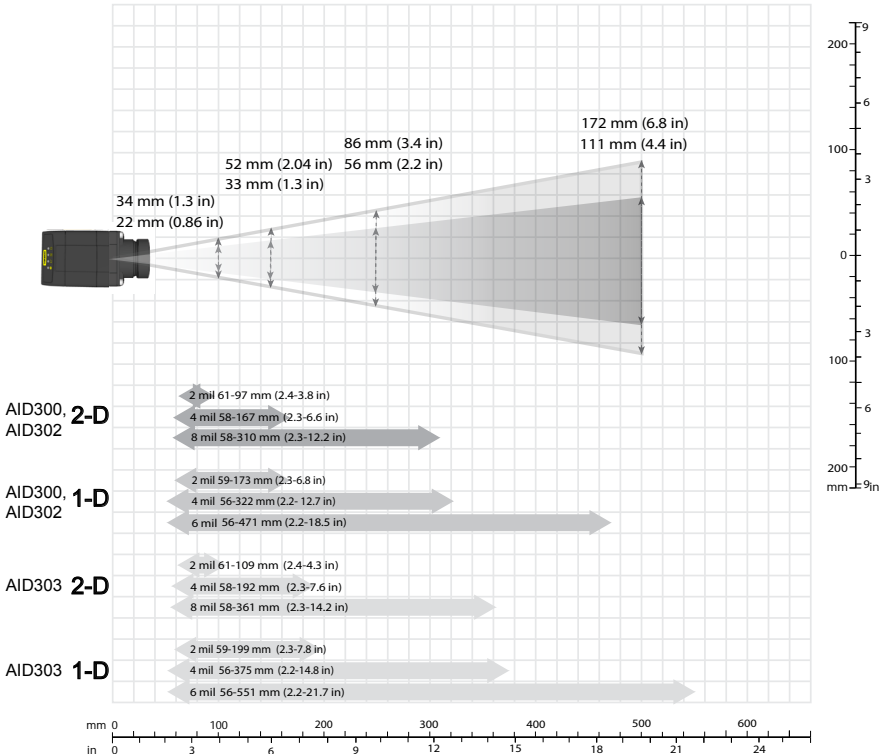

Reading Distance and Field of View (AID 360 Readers with a 25 mm Lens)

This following map shows the field of view of the AID 360 readers with a 25 mm lens.

The FOV values are shown as follows:

- outer: AID302, AID303
- inner: AID300

The reading distances for the AID300 and AID302 readers are the same. The AID303 features a higher resolution and more pixels in about the same sensor size.

The following table shows the Field of View widths in mm at various distances.

distances in mm	AID360	AID302/ AID303
50	8	12
100	16	25
150	23	37
250	39	62
500	78	125

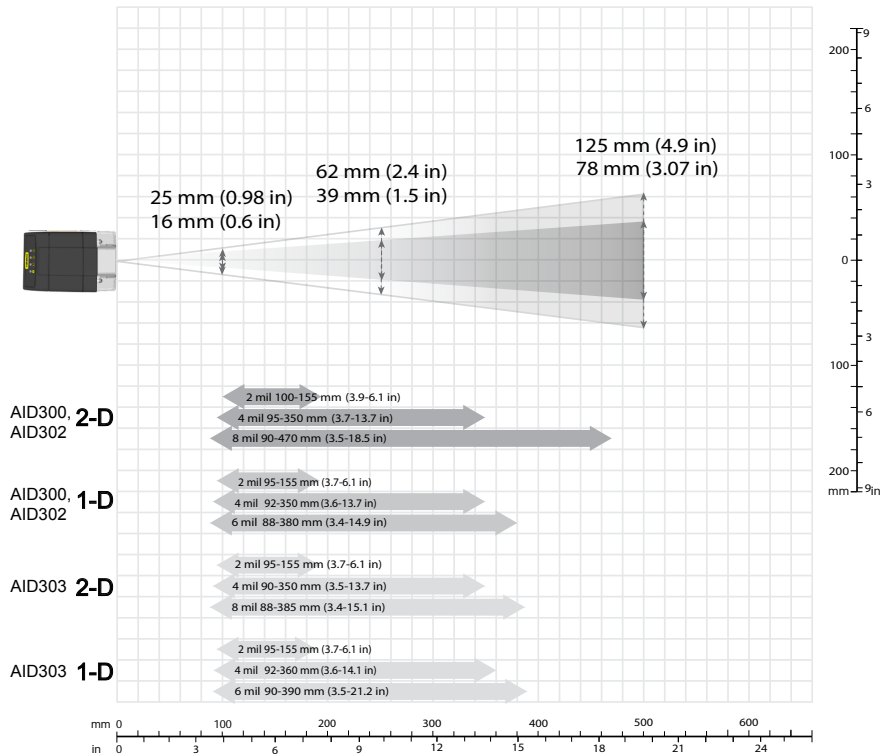

Dimensions

Observe the following AID 360 reader dimensions when installing your reader.

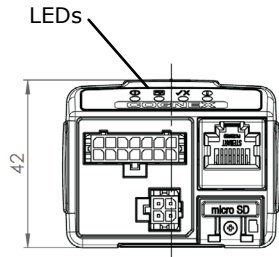
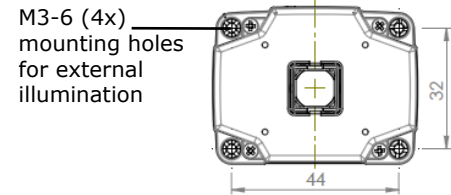
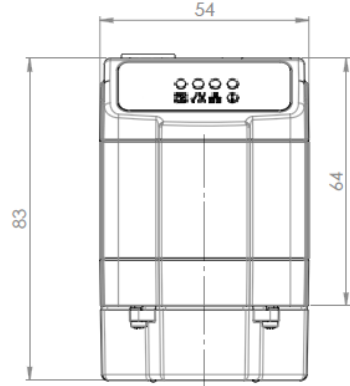
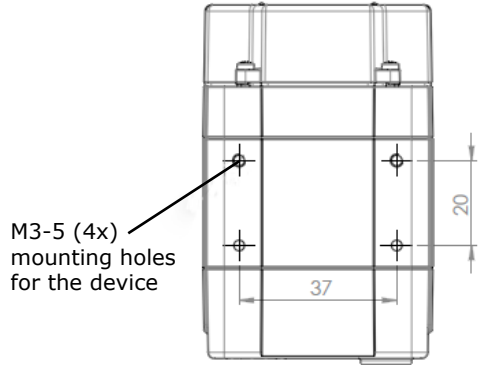

S-Mount (M12) Lens version

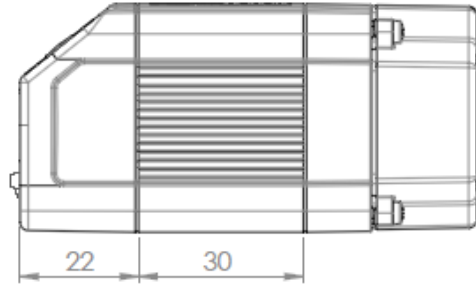

C-Mount Lens version

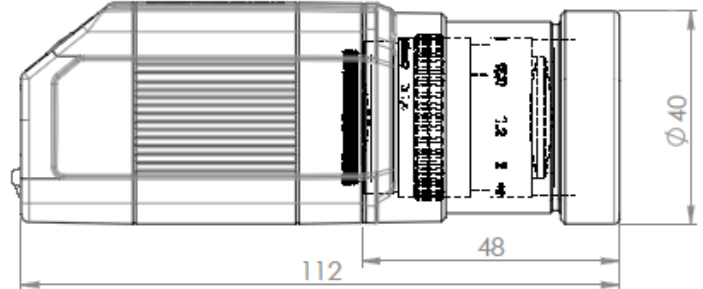

AID 360 Imager Specifications

Specification	AID 360 Imager
Image Sensor	1/1.8 inch CMOS
Image Sensor Properties	6.9 mm x 5.5 mm (H x V); 5.3 μm square pixels (AID 300 and 302), 4.5 μm square pixels (AID 303)
Image Resolution (pixels)	<ul style="list-style-type: none">• AID 300: 800 x 600• AID 302: 1280 x 1024• AID 303: 1600 x 1200
Electronic Shutter Speed	<ul style="list-style-type: none">• minimum exposure: 5 μs (AID 300 and 302), 12 μs (AID 303)• maximum exposure: 1000 μs with internal illumination/100000 μs with external illumination
Image Acquisition at Full Resolution	<ul style="list-style-type: none">• AID 300 and 302: up to 60 fps• AID 303: up to 40 fps
Lens Type	<ul style="list-style-type: none">• S-Mount 10.3 mm F:5 (with optional liquid lens)• S-Mount 16 mm F:9• C-Mount lenses (with limitations, see below)

Limitations to C-Mount lenses:

- The length of the thread may not exceed 5.4 mm.
- The back side of the lens may not exceed beyond the C-Mount threads. Possibly a lens spacer is required.
- When using the C-Mount lens cover, lens dimensions including spacer and filters may not exceed 32 x 42 mm (diameter x length).

To avoid accelerated aging of built-in illumination LEDs, which results in light intensity degradation, consider the following duty cycle limits above 25°C (77°F):

- at 35°C (95°F): 4% duty cycle, for example, 750 μs exposure and 18493 μs interval
- at 45°C (113°F): 2% duty cycle, for example, 350 μs exposure and 18093 μs interval or 1000 μs exposure and 50000 μs interval

Installing DataMan Software and Connecting the Reader

INSTALLING DATAMAN SOFTWARE AND CONNECT THE READER

1. Check the Release Notes for a full list of system requirements.
2. Insert CD-ROM and follow the on-screen prompts until you successfully completed the DataMan Software installation process.
3. Connect the AID 360 reader to your PC.
4. Launch the Setup Tool and click **Refresh**.

Detected readers will appear under **COM ports** or **Network devices**, or both.
5. Select a reader from the list and click **Connect**.



Do not stare into beam when adding, removing, or changing cables. Cognex recommends to unpower the reader any time you make physical changes to it.

CONNECT YOUR READER

1. Connect the I/O+RS232+24V cable to your reader.
2. For a network connection, connect your reader, through an Ethernet cable, to your network.
3. Connect the cable to a 24V power supply.

Troubleshooting an Ethernet Connection

Based on your network configuration, the Setup Tool may not be able to communicate with the reader and it will not appear in the list of **Network devices**.

- First check your Ethernet connection with the reader and click **Refresh** in the Setup Tool.
- Next, scan the **Enable DHCP** code in the *Reader Configuration Codes* document available from the Start menu. This might allow the reader to acquire a suitable IP address from a DHCP server on your subnet.

If the reader still does not appear, you can use either the **Add Device** or **Force Network Settings** options in the Setup Tool.

If you know the IP address of the reader, use the **Add Device** option. If you do not know the IP address, use the **Force Network Settings** options. Either method should allow the AID 360 reader to appear in the list of **Network devices** so that you can connect to it through the Setup Tool and your Ethernet connection.

You can also use the RS-232 connection to configure the reader with parameters that allow it to communicate over your Ethernet network.

For more information, see the *DataMan Setup Tool Quick Reference Guide*.

Industrial Protocols

The AID 360 readers support the following industrial protocols:

- EtherNet/IP™
- PROFINET
- MC Protocol
- Modbus TCP

Select industrial protocol samples and tools you want to use when you install the DataMan Software.

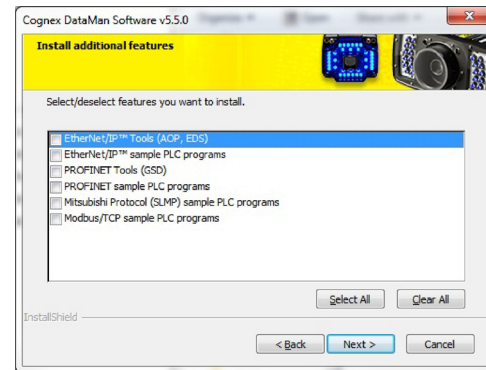

There are three ways to enable or disable Industrial Protocols. Using either method, a reboot is required for the changes to come into effect.

- Enable the protocols using the **Industrial Protocols** pane of the Setup Tool (under Communication Settings).
- Scan the appropriate **Reader Configuration codes** (see *Reader Configuration Codes* available through the Windows Start menu or the Setup Tool Help menu).
- Send the appropriate **DMCC** (see *Command Reference* available through the Windows Start menu or the Setup Tool Help menu).

For more information on using the industrial protocols, read the *DataMan Communications and Programming Guide* available through the Windows Start menu or the Setup Tool Help menu.

Test Mode

Test mode lets you configure and test a reader that is connected to a production line without needing to slow down or stop your line. To enter Test mode,

- Press the button (to which you previously assigned this function) on the device for 3 seconds
- Send a DataMan Control Command (DMCC)
- Click the Test Mode button in the Setup Tool

While in test mode, the reader by default ignores all external trigger sources and disables all input and output lines. Test mode provides two ways for you to test your reader configuration:

- **Automatic triggering** allows you to internally (automatically) trigger your device in an external trigger mode. That is, even if you select a trigger type that is external (any other than Presentation or Self trigger mode), you can trigger the reader automatically in test mode. This allows you to examine the result of each trigger and images with the configuration used in production but at a slower rate. Because inputs and outputs are disabled, the reader will not interfere with the normal operation of your line.
- Click **Accept Trigger Batch**, the reader will accept and process a limited number of external triggers (you can specify the number) at production speed. You can then examine these results and corresponding images to verify how the reader is processing triggers in production.

If needed, you can enable both inputs and outputs during test mode, but you may encounter I/O process latencies.

In both cases, you can view images and decodes using production settings but at a slower rate and without sending output signals to your line.

For more information, see the *Fixed Mount Readers Reference Manual*.

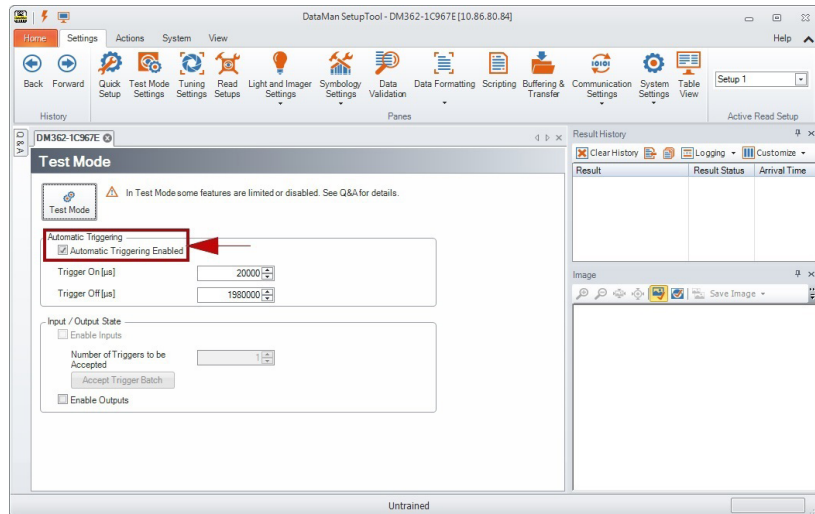

Triggering

The AID 360 readers support the following trigger modes:

- **Self:** At an interval you configure, the reader automatically detects and decodes codes in its field of view. If you set a higher re-read delay than the trigger interval, there is a code output only once until the code is out of the field of view for the duration of the re-read delay.
- **Single (external trigger):** Acquires a single image and attempts to decode any symbol it contains, or more than one symbol in cases where multicode is enabled. The reader relies on an external trigger source.
- **Presentation:** Scans, decodes and reports a single code in the field of view. The reader relies on an internal timing mechanism to acquire images.
- **Manual:** Begins acquiring images when you press the trigger button on the reader, and continues acquiring images until a symbol is found and decoded or you release the button.
- **Burst:** Performs multiple image acquisitions based on an external trigger and decodes any symbol appearing in a single image or within a sequence of images, or multiple symbols in a single image or within a sequence of images when multicode is enabled. You can control the number of images within each burst and the interval between image acquisitions.
- **Continuous:** Begins acquiring images based on a single external trigger and continues to acquire and decode images until a symbol is found and decoded, or until multiple images containing as many codes as specified in multicode mode are located, or until the trigger is released. You can configure your reader to acquire images based on the start and stop signal from separate digital IO pulses.

Multi-Reader Triggering

For trigger modes other than Presentation, the AID 360 supports *multi-reader triggering*, also known as *master-slave* configuration. In this configuration, you configure multiple AID readers as a group. Whenever any reader in the group is triggered, all the readers are triggered and the results from all the readers are assembled and transmitted by a single reader that you designate as the master.

Multi-reader triggering is used to support extended field of view reading and reading codes from multiple product surfaces:

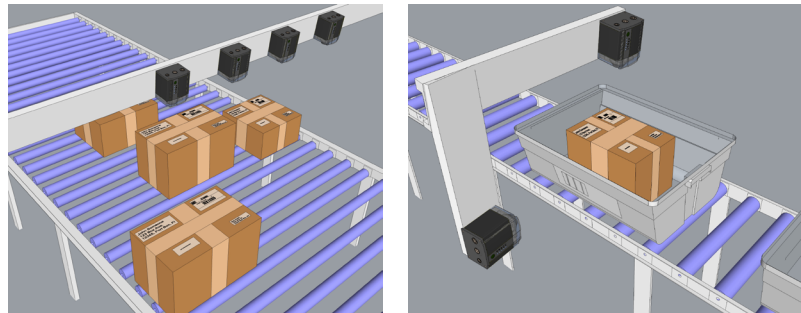

To configure multi-reader triggering, select the **Master/Slave** pane in the Setup Tool (under **System Settings**). For more information, see the *DataMan Fixed Mount Readers Reference*.

Note that AID 360 readers use IEEE1588 for high speed trigger synchronization.

Tuning

By tuning, your AID 360 reader automatically selects the best settings for the given reading situation, based on parameters of illumination, camera and decoder properties, and focal distance. Tuning autodisciminates all enabled symbologies (both 1-D and 2-D). If multiple symbols are found in the field of view, tuning locks on the first one found. Use this feature to create an optimum setting to read your codes.

You can use any of the following methods to tune your reader:

- Turn on tuning in the Setup Tool.

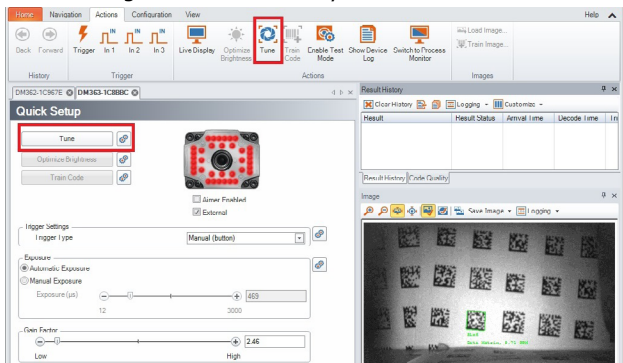

- Start tuning by sending a DMCC, for more information, see the *Dataman Control Commands Documentation*, available through the Windows **Start** menu or the Setup Tool **Help** menu.
- Use Input line 1 for tuning. Go to the Setup Tool's **System Settings** pane and check **Tune**. You can also use the **In1** button on the toolbar.

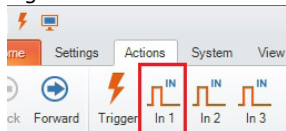

Image Filtering

You can define a stack of filters to be applied to each image acquired by your AID 360 reader. You can select the following filters on the Setup Tool's **Image Filtering** pane (under Light and Imager Settings):

- *Equalize*
This filter redistributes the brightness values of the pixels in the image. As a result, the range of brightness levels are more evenly represented. Use this filter if you have too dark or too bright images.
- *Stretch*
This filter linearly scales up or stretches the greyscale values in the input image to the full 256-step greyscale. The result is an output image with increased contrast.
- *Low Pass*
Using this filter results in output images where edges are smoothed or blurred.
- *Dilate*
This filter increases bright features and shrinks dark features. The result is an output image with larger areas of bright pixels. Use this filter to remove dark specks.
- *Erode*
This filter shrinks bright features and increases dark features. The result is an output image with larger areas of dark pixels. Use this filter to remove light specks.
- *Open*
This filter performs an erosion followed by a dilation to filter out bright features that are smaller than the size of the processing neighborhood. The result is an output image with slightly decreased overall brightness.

Image Filtering (Continued)

- *Close*

This filter performs a dilation followed by an erosion to filter out dark features that are smaller than the size of the processing neighborhood. The result is an output image with slightly increased overall brightness.

- *Auto Stretch*

This filter reduces the pixel value range. It maps the pixel values from 0 to 255.

- *Optical Density*

This filter specifies an inversion of pixel values based on a logarithmic scale. The result is an output image that reveals the density of objects and features in the input image by measuring the amount of light that passes through them. Denser objects and features are represented by lighter pixels in the output image.

- *Invert*

This filter specifies an inversion of pixel values based on the 256-step greyscale. The result is an output image that is a “negative” of the input image.

- *Median*

This is a nonlinear filtering technique which is used for noise reduction which is a typical pre-processing step to improve the results of later processing (for example, edge detection on the image). It preserves edges while removing noise.

- *Gamma correction*

This is also a nonlinear filtering technique which is used to optimize the usage of bits when encoding an image.

- *Scale*

This is a technique whereby the size of an image is reduced or enlarged, the pixels that form the image become increasingly visible, making the image appear “soft” if pixels are averaged, or jagged if not.

To use Image Filtering, perform the following steps:

1. On the Image Filtering pane, click **Add**.
2. Select a filter from the **Filter Properties** drop-down box. You can add more than one filter. You can also specify the order in which filtering is done by moving the filters using the **Up** and **Down** buttons.
3. If the filter you selected require further settings, change properties according to your needs.

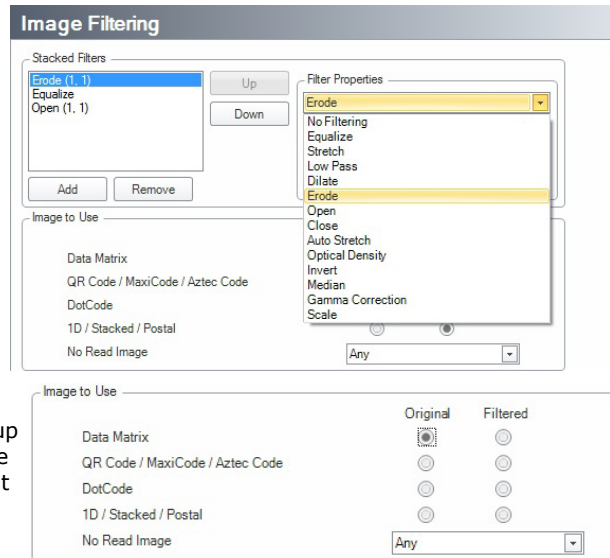

4. Change the selection in the **Image to Use** group box according to the symbology you want to be filtered (after making sure that that Symbology is enabled).

If no image is read, the Results Display shows the image according to your selection under No-Read Image.

Image Filtering (Continued)

5. Go to the **Displayed Image Settings** pane and change the Images to Use according to what you want to see on Live Display: the original or the filtered image.

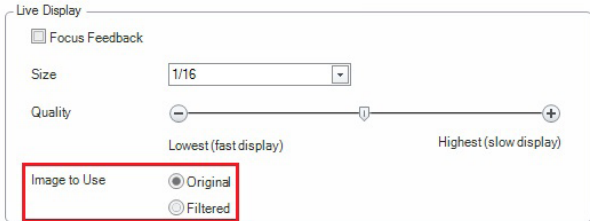

6. You can compare the original and filtered results on the **Results Display** if you choose the images from the **Read Result History**.

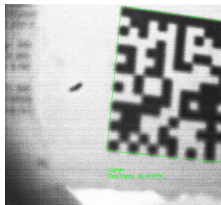

The example images were taken using the Equalize filter.

Training the Reader

Training your reader with the expected symbology can make the time required to decode successive symbols more consistent. In addition, training may help increase decode yield.

To train your reader, place a code in front of the reader and do one of the following:

- Click and hold the trigger button in the Setup Tool for a minimum of 3 seconds.

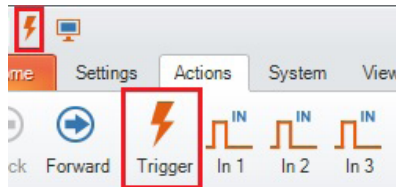

- Click **Train Code** in the Results Display pane.



You can use training in **Single**, **Burst**, **Continuous** or **Self** trigger modes.

NOTE that only a single symbol of each symbology kind can be trained.

Training the Reader (Continued)

Training Feedback

The second LED from left on the reader glows green to indicate that it is currently trained, or yellow to indicate that it is not trained.

Connect the reader to the Setup Tool to untrain it and allow it to recognize other enabled symbologies.

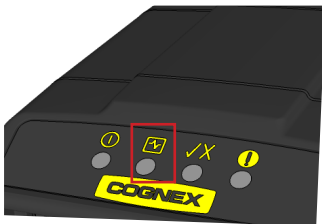

Incremental Training for Multiple Symbologies

If you want to train the reader to recognize multiple symbologies, you can present a single image showing all the desired symbologies and perform the training procedure previously described.

If you cannot present a single image showing all the necessary symbologies, you can enable incremental training on the **Training** tab of the **Symbology Settings** pane:

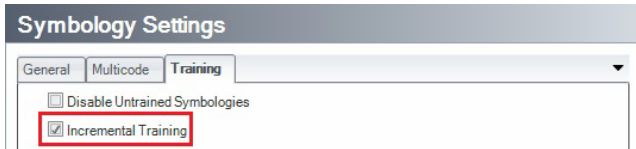

With incremental training enabled, you can train the reader using multiple images showing the symbologies you expect to decode. The reader will train each new symbology while retaining the existing trained symbologies.

Scripting

In addition to standard formatting possibilities, you have the option to **write a script** inside the Setup Tool. On the **Scripting** tab, when script-based formatting is enabled, you can define a JavaScript module to format data according to your needs. The **FTP Storage** tab is for writing scripts to generate FTP file names.

The script for data formatting not only allows you to have different data formatting combinations, but you can also perform operations on the output channel, for example, to pull output 1 up. You can configure read results flexibly and configure reader events before the result returns.

For the details of how to write the script and for scripting examples, please consult the *DataMan Communications and Programming Guide*. You can find scripting samples on the **Scripting** pane.

Package Detection Support

You can connect your package detection sensor to one of the digital inputs of your AID 360 reader. When the reader receives a signal that a package is detected, images that the reader collected are not discarded at the end of the trigger. This way you can make sure that there was a package there, only the code was not readable. Looking at the No Read images will help you find out why there was no decode results.

Package detection is only supported with Continuous trigger mode.

To make sure that the No Read images are collected, perform the following:

1. Connect your package detection device to one of the Inputs of your reader.
2. On the Setup Tool's System Settings pane's Inputs tab, check **Allow Buffered No-Read Images** on the input you connected your reader to.
3. On the Setup Tool's Image Record and Playback pane, change **What Images to Buffer** to All, or No Read.

- In case of **All**, good reads are also saved together with No Reads.
- In case of **No Read** the image is buffered if the reader fails to read.

For more information, see the *DataMan Fixed Mount Readers Reference*, available through the Windows Start menu or the Setup Tool Help menu.

External Light Control

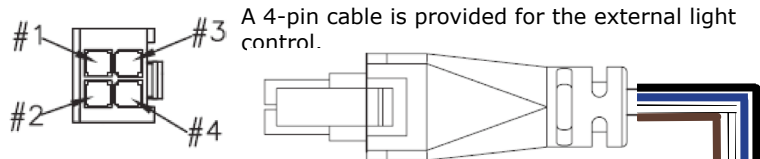

Pin #	Signal Name	Wire Color
1	+24 VDC	brown
2	Brightness Control	white
3	GND	blue
4	Strobe	black

Current load: average: 500mA, peak: 1A (max. 100µs).

NOTE that this socket does not work if the external light is connected to one of the outputs on the I/O cable.

Cable Length	Part Number
1m	185-10001-01R
2m	185-10001-02R
3m	185-10001-03R
4m	185-10001-04R
5m	185-10001-05R

1-5m Power and I/O Cable

The Power and I/O cable provides access to power and trigger and high-speed outputs. Unused wires can be clipped short or tied back using a tie made of non-conductive material.

For RS-232, use the Power Supply return path for ground.

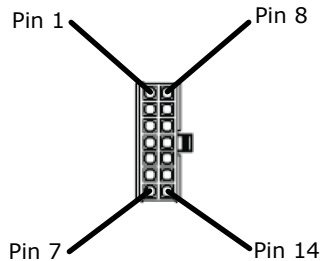

Cable Length	Part Number
2m	185-10002-02R
3m	185-10002-03R
4m	185-10002-04R
5m	185-10002-05R

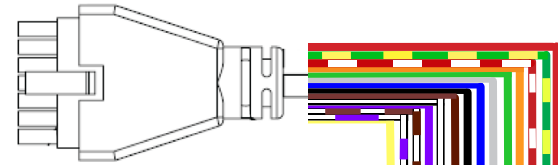

Pin #	Signal Name	Wire Color
1		Yellow
2		White/Violet
3		White/Brown
4		Violet
5		Drain (clear tube)
6		Brown
7		Black
8		Blue
9		Gray
10		Green
11		Orange
12		White/Yellow
13		Green/Yellow
14		Red

High-Speed Output Lines

The high-speed outputs can be used as either NPN (pull-down) or PNP (pull-up) lines. For NPN lines, the external load should be connected between the output and the positive supply voltage (<26.4V). The outputs pull down to less than 3V when ON, which causes current to flow through the load. When the outputs are OFF, no current flows through the load.

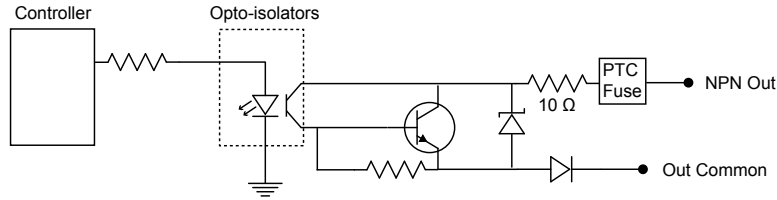

High-Speed Output Lines (Continued)

For PNP lines, the external load should be connected between the output and the negative supply voltage (0V). When connected to a 24VDC power supply, the outputs pull up greater than 21V when ON, and current flows through the load. When the outputs are OFF, no current flows through the load.

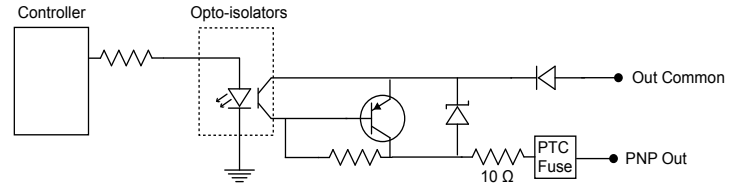

High Speed Output Wiring

To connect to an NPN-compatible PLC input, connect Output 0, Output 1, Output 2, or Output 3 directly to the PLC input. When enabled, the output pulls the PLC input down to less than 3V.

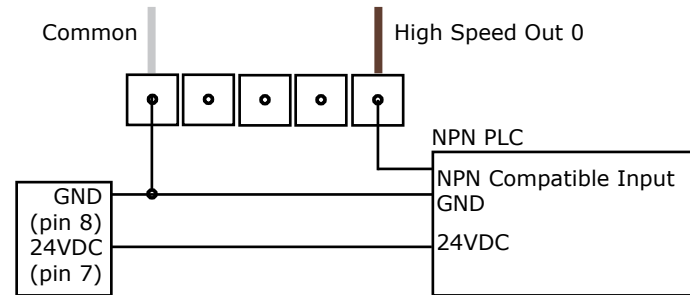

Specification	Description
Voltage	26.4V maximum through external load
Current	50mA maximum sink current
	OFF state leakage current 100µA
	External load resistance 240 Ohms to 10K Ohms
	Each line rated at a maximum 50mA, protected against over-current, short circuits and transients from switching inductive loads. High current inductive loads require external protection diode.

High Speed Output Wiring

To connect to a PNP-compatible PLC input, connect Output 0, Output 1, Output 2 or Output 3 directly to the PLC input. When enabled, the output pulls the PLC input up to greater than 21V.

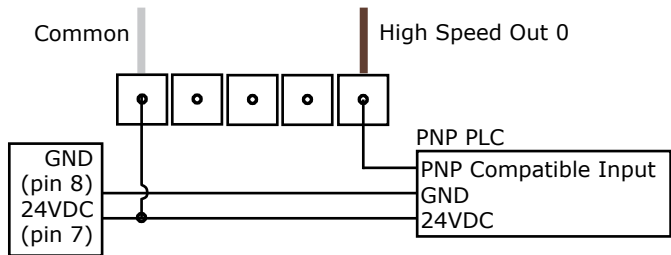

To connect the high-speed outputs to a relay, LED or similar load, connect the negative side of the load to the output and the positive side to +24V. When the output switches on, the negative side of the load is pulled down to less than 3V, and 24 appears across the load. Use a protection diode for a large inductive load, with the anode connected to the output and the cathode connected to +24V.

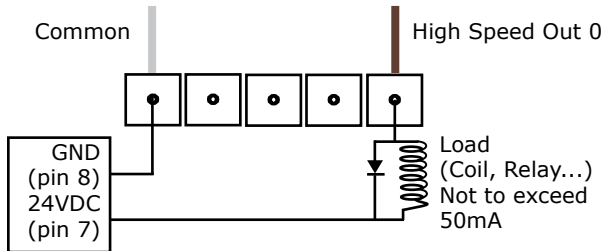

Ethernet M12 to RJ45 Cable

The Ethernet cable provides Ethernet connection for network communications. The Ethernet cable can be connected to a single device or provide connections to multiple devices via a network switch or router.

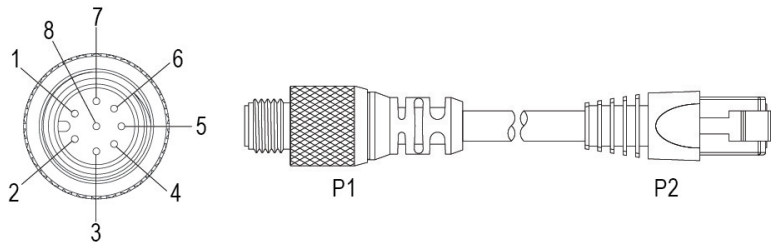

P1 Pin#	Signal Name	Wire Color	P2 Pin#
6	TPO+	White/Orange	1
4	TPO-	Orange	2
5	TPI+	White/Green	3
7	TRMA	Blue	4
1	TRMB	White/Blue	5
8	TPI-	Green	6
2	TRMC	White/Brown	7
3	TRMD	Brown	8

Note: Cables are sold separately. The wiring for this cable follows standard industrial Ethernet M12 specifications. This differs from the 568B standard.

Acquisition Triggering

The acquisition trigger input on the reader is opto-isolated. To trigger from an NPN (pull-down) type photo-detector or PLC output, connect **Common In** to +24V and connect **In 0** to the output of the detector. When the output turns on, it pulls **In 0** down to 0V, turning the opto-coupler on.

To trigger from an PNP (pull-up) photo-detector or PLC output, connect **In 0** to the output of the detector and connect **Common In** to 0V. When the output turns on, it pulls **In 0** up to 24V, turning the opto-coupler ON.

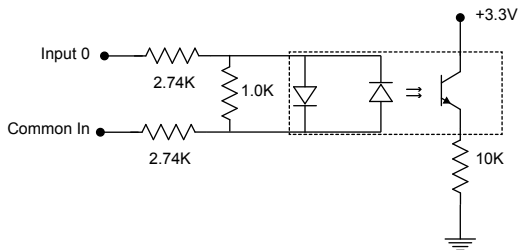

26.4V Max. across input pins - Transition approximately 12V (Min.)

Warnings and Notices



NOTE: For product support, contact <http://support.cognex.com>



CAUTION: IP protection is ensured only when all connectors are attached to cables or shielded by a sealing cap.



CAUTION: LED RADIATION - DO NOT VIEW DIRECTLY WITH OPTICAL INSTRUMENTS - CLASS 1M LED PRODUCT



LASER LIGHT, DO NOT STARE INTO BEAM: CLASS 2 LASER PRODUCT
FAILURE TO FOLLOW THESE INSTRUCTIONS MAY CAUSE SERIOUS INJURY

- CAUTION - Use of controls or adjustments or performance of procedures other than those specified herein may result in hazardous radiation exposure.
- Do not attempt to service or repair this product -- return it to Cognex for service.
- Do not permit anyone other than Cognex Corporation to service, repair, or adjust this product.
- Do not attempt to open or modify this device except as described in this document.
- Do not direct or reflect laser light toward people or reflective objects.
- Do not operate this device if it is damaged or if the covers or seals are missing or damaged.

This Laser Product is designated as Class 2 during all procedures of operation.

Wavelength	650 nm
Laser Power for classification	< 1 mW
Beam Diameter	< 3mm at aperture
Divergence	< 1.5 mrad

Compliance Statements

The AID 360 readers meet or exceed the requirements of all applicable standards organizations for safe operation. However, as with any electrical equipment, the best way to ensure safe operation is to operate them according to the agency guidelines that follow. Please read these guidelines carefully before using your device.

Regulator	Specification
USA	FCC Part 15, Class A FDA/CDRH Laser Notice No 50
Canada	ICES-003
European Community	EN55022:2006 +A1:2007, Class A
	EN55024:1998 +A1:2001 +A2: 2003
	EN60950
	EN60825-1
Australia	C-TICK, AS/NZS CISPR 22 / EN 55022 for Class A Equipment
Japan	J55022, Class A

FCC Class A Compliance Statement



This equipment has been tested and found to comply with the limits for a Class A digital device, pursuant to Part 15 of the FCC rules. These limits are designed to provide reasonable protection against harmful interference when the equipment is operated in a commercial environment. This equipment generates, uses, and can radiate radio frequency energy and, if not installed and used in accordance with the instructions, may cause harmful interference to radio communications. Operation of this

equipment in a residential area is likely to cause harmful interference, in which case the user will be required to correct the interference at personal expense.

Canadian Compliance

This Class A digital apparatus complies with Canadian ICES-003.
Cet appareil numérique de la classe A est conforme à la norme NMB-003 du Canada.

C-Tick Statement



Conforms to AS/NZS CISPR 22/ EN 55022 for Class A Equipment.

European Compliance



The CE mark on the product indicates that the system has been tested to and conforms to the provisions noted within the 2004/108/EEC Electromagnetic Compatibility Directive and the 2006/95/EEC Low Voltage Directive.

For further information please contact:

Cognex Corporation
One Vision Drive
Natick, MA 01760
USA

Cognex Corporation shall not be liable for use of our product with equipment (i.e., power supplies, personal computers, etc.) that is not CE marked and does not comply with the Low Voltage Directive.

Laser Safety Statement



Compliance with FDA performance standards for laser products except for deviations pursuant to Laser Notice No. 50, dated June 24, 2007.

This device has been tested in accordance with IEC60825-1 2nd ed., and has been certified to be under the limits of a Class 2 Laser device.



Use of controls or adjustments or performance of procedures other than those specified herein may result in hazardous radiation exposure.

UL and cUL Statement



UL and cUL listed: UL60950-1 2nd ed. and CSA C22.2 No.60950-1 2nd ed.

For European Community Users

Cognex complies with Directive 2002/96/EC OF THE EUROPEAN PARLIAMENT AND OF THE COUNCIL of 27 January 2003 on waste electrical and electronic equipment (WEEE).

This product has required the extraction and use of natural resources for its production. It may contain hazardous substances that could impact health and the environment, if not properly disposed.

In order to avoid the dissemination of those substances in our environment and to diminish the pressure on the natural resources, we encourage you to use the appropriate take-back systems for product disposal. Those systems will reuse or recycle most of the materials of the product you are disposing in a sound way.



The crossed out wheeled bin symbol informs you that the product should not be disposed of along with municipal waste and invites you to use the appropriate separate take-back systems for product disposal.

If you need more information on the collection, reuse, and recycling systems, please contact your local or regional waste administration.

You may also contact your supplier for more information on the environmental performance of this product.

AID 360 Specifications

Weight	165 g			
Operating Temperature	0°C — 45°C (32°F — 113°F)			
Storage Temperature	-10°C — 60°C (-14°F — 140°F)			
Maximum Humidity	95% (non-condensing)			
Environmental	IP65 (with cable or protection cap attached to all connectors, front cover properly installed)			
Vibration	EN61373 including IEC 60068-2-6, 60068-2-64 6.4, and 60068-2-27			
RS-232	Rx/D, Tx/D according to TIA/EIA-232-F			
Codes	Data Matrix™ (IDMax: ECC 0, 50, 80, 100, 140, and 200; IDQuick: ECC200) QR Code and microQR Code, MaxiCode, Aztec Code UPC/EAN/JAN Codabar, Interleaved 2 of 5, Code 39, Code 128, and Code 93, Pharma, Postal, RSS/CS, PDF 417, MicroPDF 417, MSI			
Discrete I/O operating limits	HS Output 0,1	IMAX @ 24 VDC RMAX @ 12 VDC @ 24 VDC	50 150 470	mA Ω Ω
	Input 0 (Trigger) Input 1	VIH VIL ITYP @ 12 VDC @ 24 VDC	±15 — ±25 0 — ±5 2.0 4.2	V V mA mA
Power Supply Requirements	24V +/- 10%	Maximum current: 250 mA (internal illumination) 850 mA (internal + external lights) Maximum power: 5W (internal illumination) 18W (internal + external lights)		
Light Connector	Current load	Average: 500mA Peak: 1A (max. 100µs)		
Ethernet Speed	10/100			
Duplex Mode	Full duplex or half duplex			

Reader Programming Codes

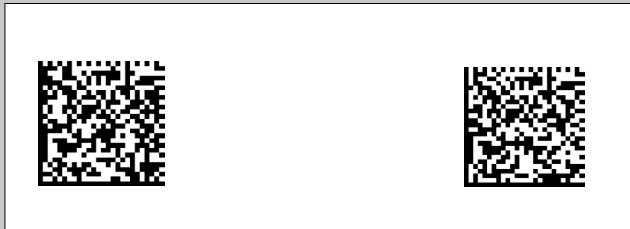

Reset Scanner to
Factory Defaults

Reboot Scanner

Copyright © 2015 Cognex Corporation All Rights Reserved. This document may not be copied in whole or in part, nor transferred to any other media or language, without the written permission of Cognex Corporation. The hardware and portions of the software described in this document may be covered by one or more of the U.S. patents listed on the Cognex web site <http://www.cognex.com/patents.asp>. Other U.S. and foreign patents are pending. Cognex, the Cognex logo, and DataMan are trademarks, or registered trademarks, of Cognex Corporation.

