

**DataMan[®] 8072 Handheld
Verifier
Reference Manual**

2020 April 14
Revision: 6.1.6.4

Legal Notices

The software described in this document is furnished under license, and may be used or copied only in accordance with the terms of such license and with the inclusion of the copyright notice shown on this page. Neither the software, this document, nor any copies thereof may be provided to, or otherwise made available to, anyone other than the licensee. Title to, and ownership of, this software remains with Cognex Corporation or its licensor. Cognex Corporation assumes no responsibility for the use or reliability of its software on equipment that is not supplied by Cognex Corporation. Cognex Corporation makes no warranties, either express or implied, regarding the described software, its merchantability, non-infringement or its fitness for any particular purpose.

The information in this document is subject to change without notice and should not be construed as a commitment by Cognex Corporation. Cognex Corporation is not responsible for any errors that may be present in either this document or the associated software.

Companies, names, and data used in examples herein are fictitious unless otherwise noted. No part of this document may be reproduced or transmitted in any form or by any means, electronic or mechanical, for any purpose, nor transferred to any other media or language without the written permission of Cognex Corporation.

Copyright © 2019. Cognex Corporation. All Rights Reserved.

Portions of the hardware and software provided by Cognex may be covered by one or more U.S. and foreign patents, as well as pending U.S. and foreign patents listed on the Cognex web site at: cognex.com/patents.

The following are registered trademarks of Cognex Corporation:

Cognex, 2DMAX, Advantage, AlignPlus, Assemblyplus, Check it with Checker, Checker, Cognex Vision for Industry, Cognex VSOC, CVL, DataMan, DisplayInspect, DVT, EasyBuilder, Hotbars, IDMax, In-Sight, Laser Killer, MVS-8000, OmniView, PatFind, PatFlex, PatInspect, PatMax, PatQuick, SensorView, SmartView, SmartAdvisor, SmartLearn, UltraLight, Vision Solutions, VisionPro, VisionView

The following are trademarks of Cognex Corporation:

The Cognex logo, 1DMax, 3D-Locate, 3DMax, BGAll, CheckPoint, Cognex VSoC, CVC-1000, FFD, iLearn, In-Sight (design insignia with cross-hairs), In-Sight 2000, InspectEdge, Inspection Designer, MVS, NotchMax, OCRMax, PatMax RedLine, ProofRead, SmartSync, ProfilePlus, SmartDisplay, SmartSystem, SMD4, VisiFlex, Xpand

Portions copyright © Microsoft Corporation. All rights reserved.

Portions copyright © MadCap Software, Inc. All rights reserved.

Other product and company trademarks identified herein are the trademarks of their respective owners.

Table of Contents

Legal Notices	2
Table of Contents	3
Symbols	5
About DataMan 8072V	5
DataMan 8072V Kits	6
DataMan 8072V1 Accessories	7
Cables	8
Physical Layout of the DataMan 8072V Verifier	8
Setting Up the Verifier	10
Install the DataMan SetupTool	13
DataMan 8072V Specifications	13
DataMan 8072V Imager Specifications	13
LED Wavelengths	13
Calibration	13
Using Your DataMan 8072V Verifier	15
Verifying a 2D Barcode	15
Selecting Regions	17
Examining the Results	17
Main	17
General Characteristics	18
Data Detail	18
Quality Detail	19
Advanced Detail	19
Histogram	20
Report	22
User Interface	24
Toolbar	24
Adjusting the Focus Height	24
Illumination Icons	26
Settings	28
Accessing the Settings Menu	28
Application Settings	28
Application Standards Settings	28
Grading Standards	32
Data Format Check	32
Reporting Settings	34
Grading Standards and their Parameters	37
ISO/IEC 15415 Grading Parameters	37
ISO 29158 (AIM-DPM) 2006 Grading Parameters	41
Traditional (Non-Graded) Parameters	42
PCS	42
MRD	43
Cleaning/Maintenance	44

Cleaning the Reader Housing	44
Cleaning the Reader Lens Cover	44
Regulations/Conformity	45
中国大陆 RoHS (Information for China RoHS Compliance)	46
Precautions	47

Symbols

The following symbols indicate safety precautions and supplemental information:

⚠ WARNING: This symbol indicates a hazard that could cause death, serious personal injury or electrical shock.

⚠ CAUTION: This symbol indicates a hazard that could result in property damage.

ℹ Note: This symbol indicates additional information about a subject.

💡 Tip: This symbol indicates suggestions and shortcuts that might not otherwise be apparent.

About DataMan 8072V



The DM8072V verifier is designed to change the direct part mark (DPM) barcode verification experience. The versatile DM8072V is packed with powerful lighting options, a fast processing engine, and a high-resolution camera to capture and grade even the most difficult DPM barcodes up to four times quicker than other verifiers on the market. As the only DPM verifier with 30, 45 and 90-degree lighting options, the DM8072V can easily illuminate codes on textured, curved, and even recessed surfaces. Grade Data Matrix and QR codes against ISO and application standards with easy to read results displayed on the DataMan Setup Tool software. The all-new user interface provides more detailed reporting and diagnostic capabilities than ever before.

The DataMan 8072V verifiers are available with the following communication options:

- Ethernet
- USB

The DataMan 8072V verifiers provide the following features:

- Accurate barcode verification according to ISO global standards
- 2D Imager with integrated illumination
- Repeatable and accurate results
- Calibrated and traceable to NIST standards
- Easy-to-use software interface

- Detailed reporting
- Export of verification results in Adobe PDF™
- Consistent results independent of operator training or skill
- Adjustable height stand with Focus Indicator (available as an option)

DataMan 8072V Kits

The DataMan 8072V Verifier is available in the following kits:

Model number	Description
DMV-8072V-S-0200	DataMan 8072V Verifier Ethernet Kit with Stand: <ul style="list-style-type: none"> - 8072V Verifier - Standoff - Ethernet Slide-In - Ethernet Cable Attachment - Standard Ethernet Cable - POE Injector - Basic Calibration Card - Stand Accessory
DMV-8072V-S-0100	DataMan 8072V Verifier USB Kit with Stand: <ul style="list-style-type: none"> - 8072V Verifier - Standoff - USB Slide-In - USB Cable - Power Supply - Basic Calibration Card - Stand Accessory
DMV-8072V-0200	DataMan 8072V Verifier Ethernet Kit: <ul style="list-style-type: none"> - 8072V Verifier - Standoff - Ethernet Slide-In - Ethernet Cable Attachment - POE Injector - Basic Calibration
DMV-8072V-0100	DataMan 8072V Verifier USB Kit <ul style="list-style-type: none"> - 8072V Verifier - Standoff - USB Slide-In - USB Cable - Power Supply - Basic Calibration Card
DMV-8072V-0000	DataMan 8072V Verifier Kit <i>No Slide-In</i> <ul style="list-style-type: none"> - 8072V Verifier - Standoff - Basic Calibration Card

DataMan 8072V verifier and stand-off



Ethernet or USB slide-in







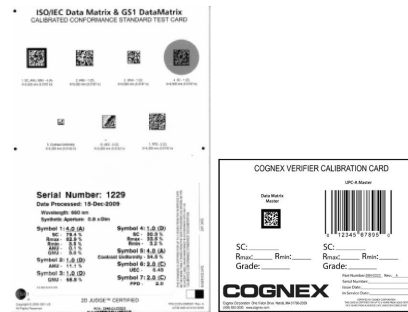

Stand accessory



Calibration card



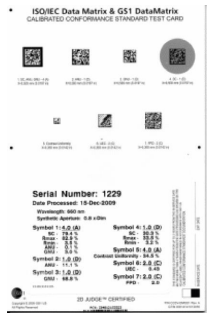

DataMan 8072V1 Accessories

Ethernet slide-in	DMCM-ENETM-00	
Serial/USB 2.0 slide-in	DMCM-USB2EN-00	
Power Supply for USB 2.0 slide-in	DM100-PWR-000	
POE hub	CPS-AC-POE1A-US	
Stand accessory	DMV-8072V-STAND	
Cognex Basic Calibration Card	DMV-CCC DMV-WCC	

GS1 Conformance Calibration Card	DMV-GS1CC	
Validation Protocol DM8072V	DMV-VPS-DPM	

Cables

USB cable for USB 2.0 slide-in, 2.5 m	DM8500-USBC-02	
Ethernet cable for Ethernet slide-in, 5 m	DM8000-ECABLE-05	
Standard Ethernet cable	CBL-C10E	

Physical Layout of the DataMan 8072V Verifier

 **WARNING: LASER LIGHT, DO NOT STARE INTO BEAM**

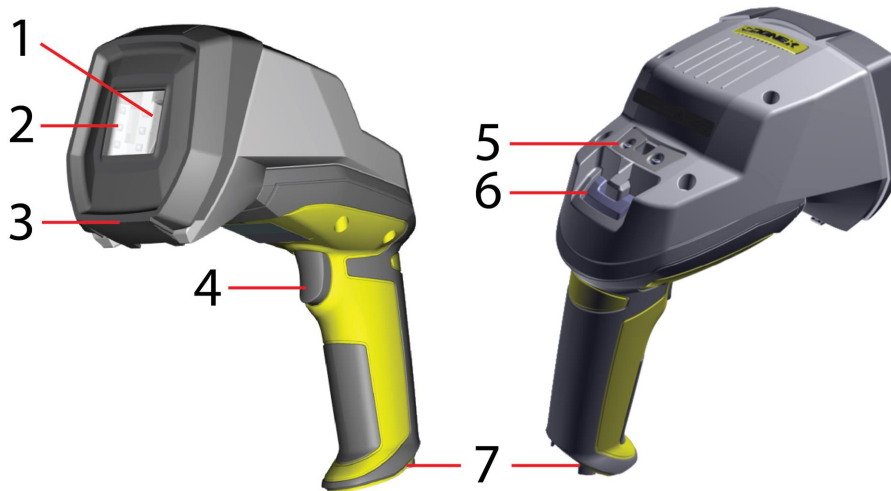

1	Imager and Lens Optical System
2	Illumination
3	Removable Standoff
4	Trigger (press and release)
5	Lanyard hook
6	Indicator light
7	Communication module insertion point

Status indicator Light:

- Communication:
 - GREEN = good verification
 - RED = bad verification

 **Note:** For more information on the DataMan 8072V hardware, see the *DataMan 8072 Verifier Quick Reference Guide*.

Setting Up the Verifier

To be able to connect to your reader on your computer, you must perform the following steps:

1. [Install the DataMan Setup Tool](#) on your computer.

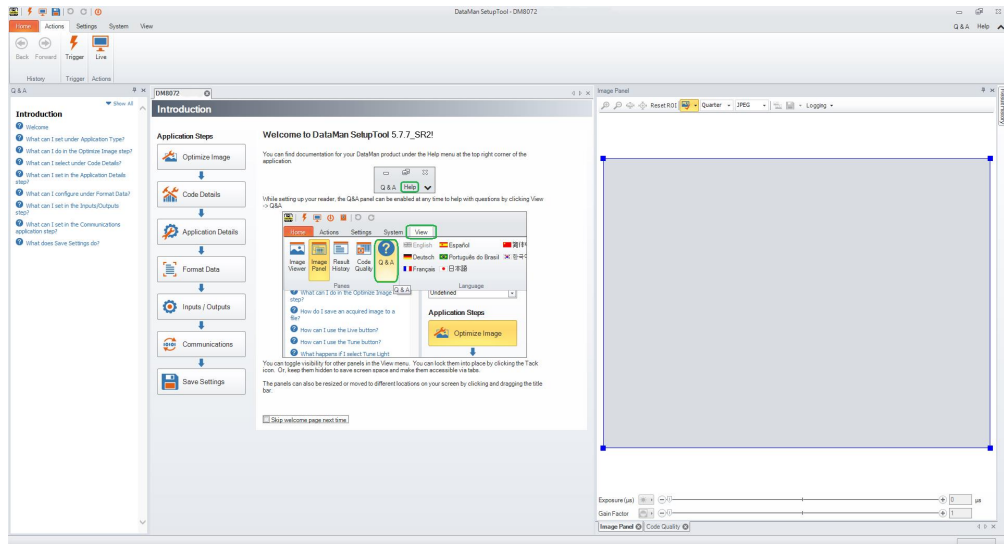

2. Select the connection type: Ethernet or USB; and connect the appropriate cabling.



Ethernet



USB

3. Power on your device(s).
4. Open the DataMan Setup Tool and connect to your DataMan 8072V verifier. The TruCheck verification application automatically opens after the unit is successfully connected.

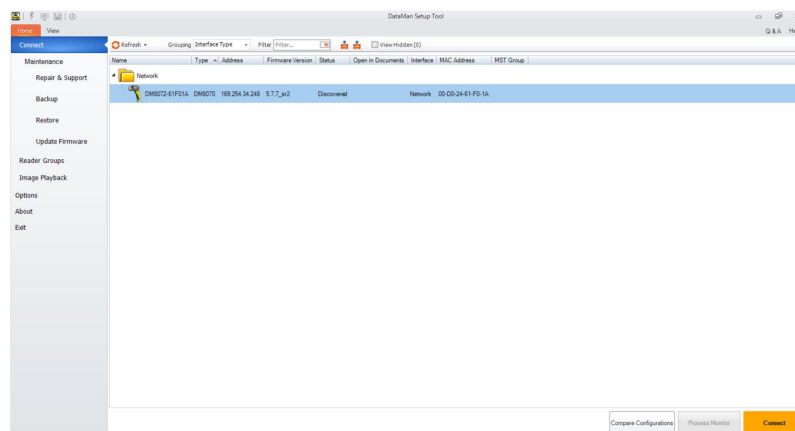

Tip: If the TruCheck verification window does not automatically open, or is closed during use, it can be re-opened by selecting the View tab in the Setup Tool and selecting the icon for “TruCheck Window”.

For some computers, connecting to a verifier using a USB 2.0 slide-in requires additional steps. Some Windows PCs have USB Selective Suspend enabled by default and this must be disabled for the USB interface to work correctly. If this occurs, follow these steps to correct the problem:

1. Select the Start button in the bottom left corner of your computer and select the Settings icon.



2. Select System, then select Power & sleep.
3. In the Power & sleep menu, select Additional Power Settings. This option is found on the right side of the window under Related Settings. This will open the Power Options menu.

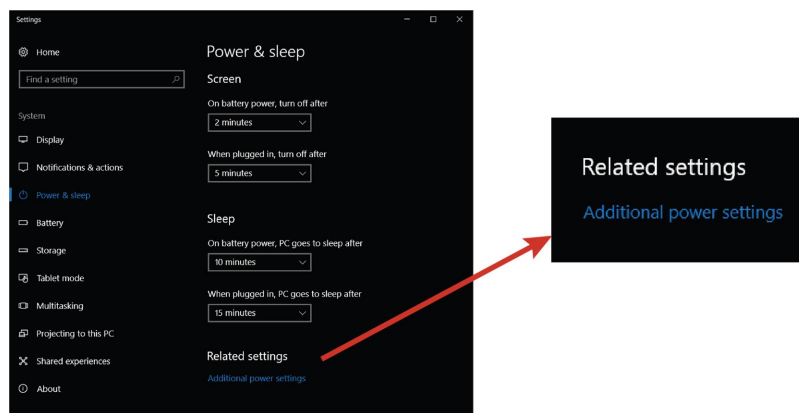

4. In the Power Options menu, select Change plan settings on the power plan that is currently selected. The Edit Plan Settings menu opens.

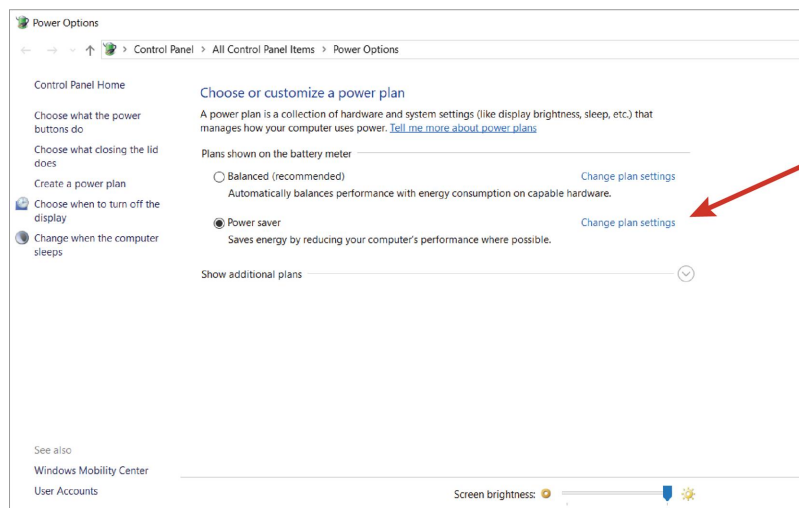

5. In the Edit Plan Settings menu, select Change advanced power settings. The Power Options menu opens.
6. Under the Power Options menu's Advanced settings tab, locate USB Settings. Select [+] for both USB Settings and USB selective suspend setting. Under this selection, there are options for On Battery and Plugged In. Set both to Disable by selecting from the drop down menu.

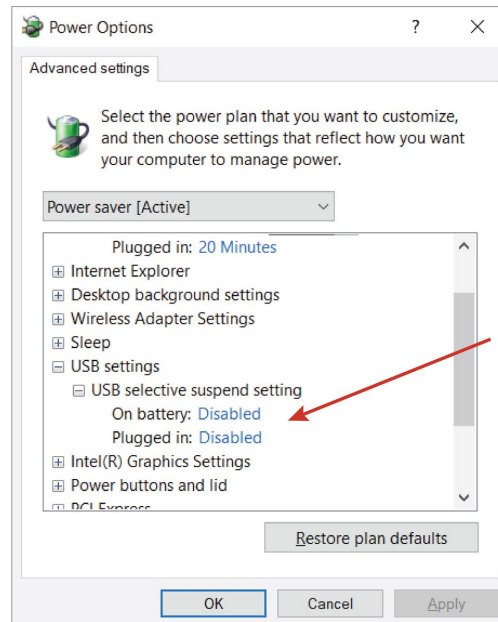

7. Click OK and restart your computer.
8. Open the Setup Tool and plug in the USB 2.0 slide-in. The 8072V now appears in the device list.
9. If the 8072V does not appear in the device list, go to *Start- > Devices and Printers -> LAN7500 [right-click] -> Troubleshoot* and see if that fixes the problem.
10. If you still do not see the 8072V in the device list, open a web browser and search for "LAN 7500 USB to Ethernet Adaptor for windows X" [X = 7 or 10 or latest edition being used] and download it. Reboot the verifier and try again.

Install the DataMan SetupTool

1. Check the DataMan **Release Notes** for a full list of system requirements.
2. Download the DataMan Setup Tool from <http://www.cognex.com/support/dataman> and follow the on-screen steps.
3. Connect the DataMan 8072V to your PC.
4. Launch the DataMan Setup Tool and click **Refresh**. The verifier appears under **COM ports** or **Network devices**.
5. Select your DataMan 8072V from the list and click **Connect**.

Note: You must have Adobe Acrobat Reader installed to view the Report tab in the TruCheck window. If you do not have Adobe Acrobat Reader installed, you can still save reports as PDFs.

DataMan 8072V Specifications

Weight	400 g (including grip assembly with battery)
Operating Temperature	0°C — 45°C (32°F — 113°F)
Storage Temperature	0°C — 60°C (32°F — 140°F)
Maximum Humidity	95% (non-condensing)
Environmental	IP65
Codes	2-D barcodes: Data Matrix™ (IDMax and IDQuick: ECC200), QR Code
Power Supply Requirements	USB: bus powered (optionally: external 6W max LPS or NEC class 2 power supply +5V - +6V DC) ETH: Class 2 PoE supply IEEE 802.3af (connect only to PoE networks without routing to the outside plant)
Inrush current peak	5A maximum Duration: approx. 30µs
Ethernet	10/100 Base-T FULL/HALF DUPLEX, IEEE 802.3

DataMan 8072V Imager Specifications

Specification	DataMan 8072V Imager
Image Sensor	1/3 inch CMOS global shutter
Image Sensor Properties	3.75 µm square pixels
Image Resolution (Pixels)	1280 x 966
Lens Type	12 mm F:4 S-mount lens

LED Wavelengths

The following table shows LED types and the related wavelengths:

LED	λ [nm]
RED	660

Calibration

Before starting to use the DataMan 8072V verifier for verifying barcodes, the device needs to be calibrated. Perform the following steps to calibrate the unit.

1. In the TruCheck Verification window, click the Calibration icon in the top left corner.
2. Enter the Rmax and Rmin values from the calibration card.

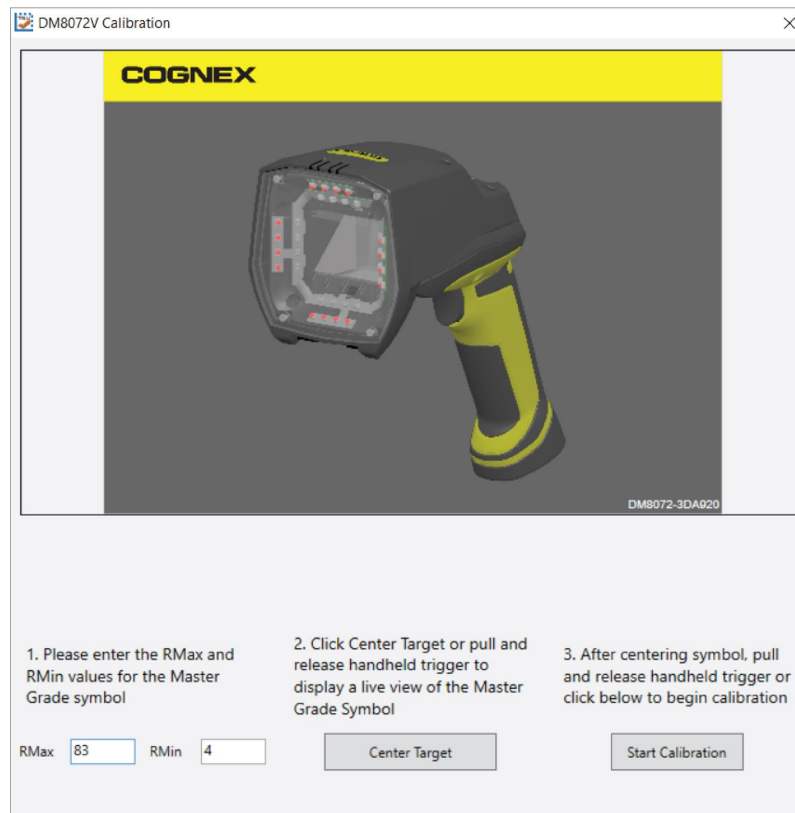

3. Select the **Center Target** button. A live image appears in the Calibration screen. Center the verifier over the Master Symbol on the Data Matrix symbol of your traceable calibration card.
4. Once the symbol is centered in the field of view, select **Start Calibration**.
5. The verifier goes through a series of lighting calibrations. After a successful calibration, the following window pops up:

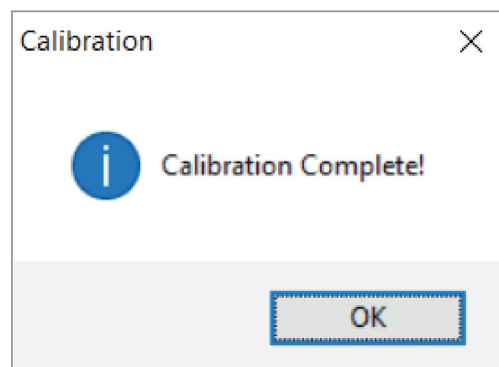

Using Your DataMan 8072V Verifier

Verifying a 2D Barcode

In the TruCheck Verification window, perform the following steps to verify a Data Matrix code or a QR code:

1. Navigate to the **Main** tab.
2. Select **Go Live**, and center your symbol in the screen. Alternately, press and release the trigger button to **Go Live**.

Note: After selecting **Go Live**, the button changes to **Verify**.

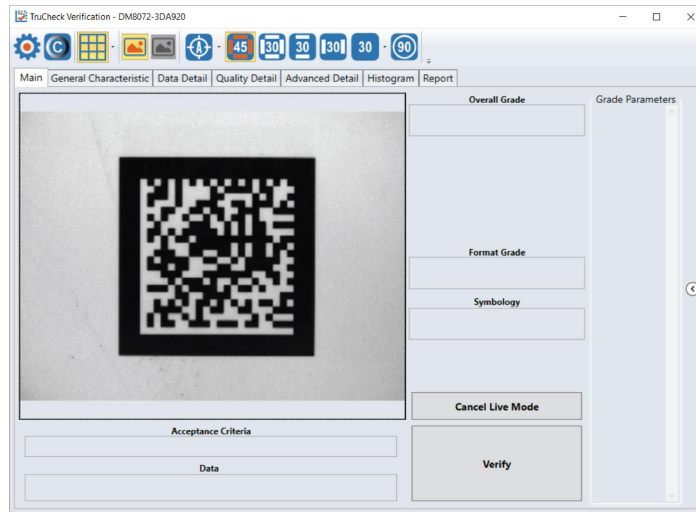

3. If necessary, draw a selection region around the code to be verified (see [Selecting Regions on page 17](#)).

Note: The region must be drawn around the outside perimeter of the code including quiet zones. More information on properly defining regions is explained in [Selecting Regions on page 17](#).

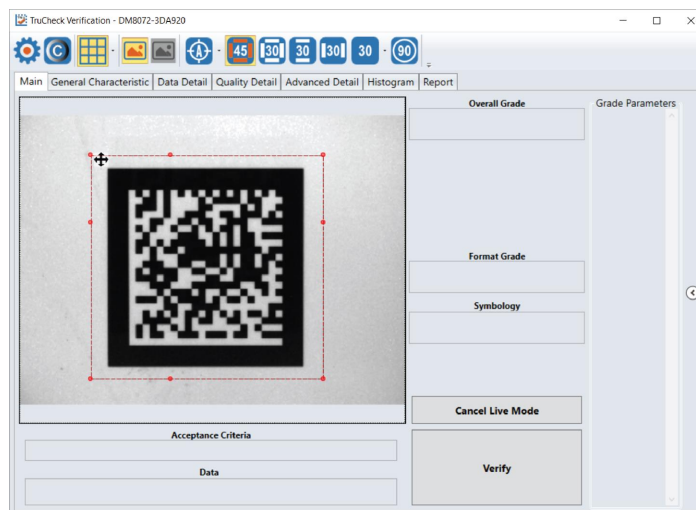

- Once you have made your region selection, click **Verify** or press and release the trigger button on the verifier to begin verification.

Note: The following screenshot shows a successful 2D barcode verification. Depending on grading and application standards, additional details are displayed.

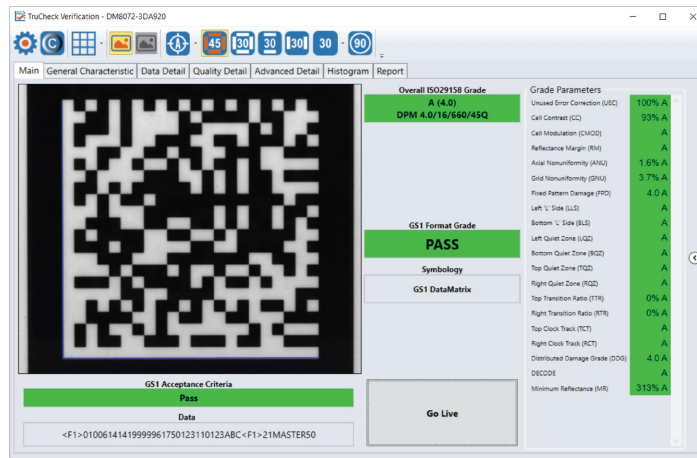

Note: The tool bar buttons and tabs shown on the screen are useful for in-depth analysis of codes. For more information, see [Examining the Results on page 17](#).

Selecting Regions

Specifying regions in the live image may be required for the following reasons:

- If the code is off center.
- Speed up the verification process on verifiers with large fields of view. Defining a small sampling area will increase the speed.
- To restrict a region used to adjust the image brightness when grading according to AIM-DPM (ISO/IEC 29158).
- To specify a barcode for verification when more than one barcode is present in the field of view.

If you do not define a region, the whole image is used.

To define a region, position your cursor where you want the region to start, hold the left mouse button down and begin drawing a box by moving the mouse. Release the button when you are done.

For Data Matrix symbols and QR Codes, draw the region surrounding the entire code. The verifier needs the entire finder pattern, including quiet zones, within the selection to properly grade the code.

Examining the Results

This section details in a tab-by-tab fashion how the results of the verification can be viewed and analyzed.

Main

After verification, the Main menu shows a snapshot of the verification results.

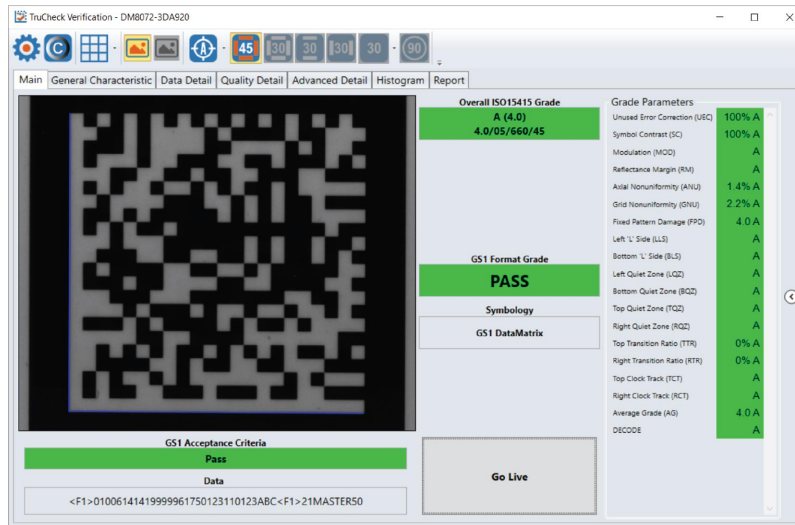

Acceptance Criteria: This box will provide a Pass/Fail grade for the barcode and is dependent on the Application Standard selected.

Data: This box will show the decoded data. If the data is longer than the box provided, the data will develop a scroll bar to show the remaining data.

Overall Grade: This box will show the overall grade results for the barcode as both a letter grade and numeric grade in the format of A (4.0). In addition, a Formal Grade is provided in the format "Grade/Aperture/Wavelength/Lighting". For example, a Formal Grade of "4.0/08/660/45" is interpreted as receiving a grade of 4.0 using 8 mil aperture (0.2 mm), 660 nm wavelength, and 45° lighting.

Format Grade: This box will provide the Format Grade of the barcode and is dependent on the either Application Standard or Data Format Check criteria selected.

Symbology: This box will report what type of symbology was detected and used for verification.

Grade Parameters: This box will provide information on the Quality Parameters grading for the barcode. More detailed information for these parameters is found on the Quality Detail tab. If the Grade Parameters is not visible on the Main menu, select the arrow on the right side of the menu to open it.

General Characteristics

The **General Characteristic** tab shows the physical characteristics of the verified barcode.

The following image shows the characteristics of a Data Matrix barcode:

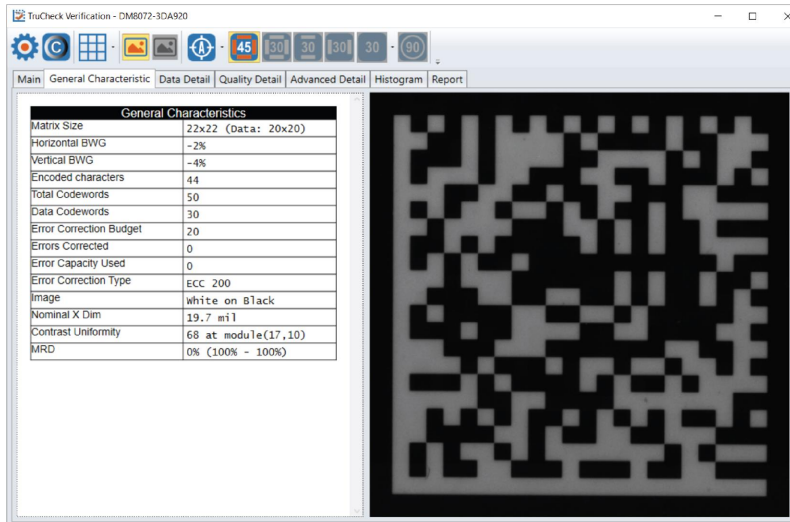

The **Contrast Uniformity** value, which is important for verifying conformance with ISO/IEC 15426-2 is also shown in this tab. Some of the contents of this screen depends on the symbology and settings on the **Report Settings** menu.

Data Detail

When viewing the **Data Detail** tab, all of the data content of the symbol is shown. Detail depends on the symbology and the selected application standards.

The following screen shows a Data Matrix with encoding information:

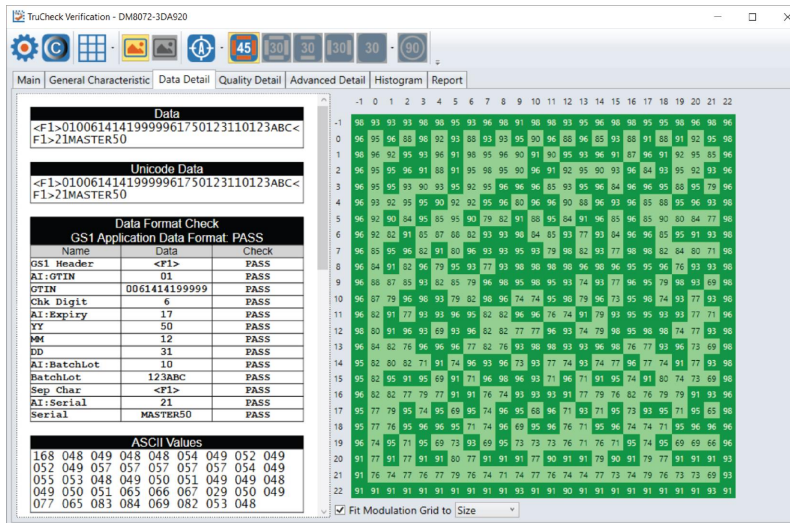

When a data checking failure occurs, a message will indicate the cause of the failure. For example, if a check digit is incorrect, a message will indicate the expected check digit value. When an error is detected, it is reported and the parsing is stopped.

The following screen shows the data Matrix with encoding information along with a depiction of the symbol to the right showing each module.

When the cursor is placed over the codewords reported in the Data Matrix Codeword table, the eight modules of that codeword are highlighted within the image depiction to show where the data is encoded within a data matrix symbol.

Quality Detail

The measured quality parameters are shown in this tab, and the formal grade is listed here. Different symbologies and quality grading standards display pertinent data here.

For example, the following screenshot shows the characteristics of a 2D Data Matrix code graded according to ISO 15415.

The screenshot shows the 'Quality Detail' tab in the TruCheck Verification software. The window title is 'TruCheck Verification - DM8072-3DA920'. The interface includes a toolbar with icons for settings, help, and navigation. The main content area is divided into two sections: a table of ISO 15415 Quality Parameters and a grayscale image of a Data Matrix code.

ISO 15415 Grade				
Overall	Aperture	Wavelength	Lighting	Formal
A (4.0)	5	660	45	4 0/05/660/45

ISO 15415 Quality Parameters				
1. Unused Error Correction (UEC)	A	100%		PASS
2. Symbol Contrast (SC)	A	100%	R/Rd (100/100)	PASS
3a. Modulation (MOD)	A			PASS
3b. Reflectance Margin (RM)	A			PASS
4. Axial Nonuniformity (ANU)	A	1.4%		PASS
5. Grid Nonuniformity (GNU)	A	2.2%		PASS
6. Fixed Pattern Damage (FPD)	A	4.0		PASS
7. Left 'L' Side (LLS)	A			PASS
8. Bottom 'L' Side (BLS)	A			PASS
9. Left Quiet Zone (LQZ)	A			PASS
10. Bottom Quiet Zone (BQZ)	A			PASS
11. Top Quiet Zone (TQZ)	A			PASS
12. Right Quiet Zone (RQZ)	A			PASS
13. Top Transition Ratio (TTR)	A	0%		PASS
14. Right Transition Ratio (RTR)	A	0%		PASS
15. Top Clock Track (TCT)	A			PASS
16. Right Clock Track (RCT)	A			PASS
17. Average Grade (AG)	A	4.0		PASS
18. DECODE	A			PASS

Detailed explanation on the grading standards can be found in [Grading Standards and their Parameters on page 37](#).

Advanced Detail

This tab shows in-depth information on the verified code. The particular info shown depends on the type of the verified barcode.

The below example shows the modulation values from a Data Matrix symbol:

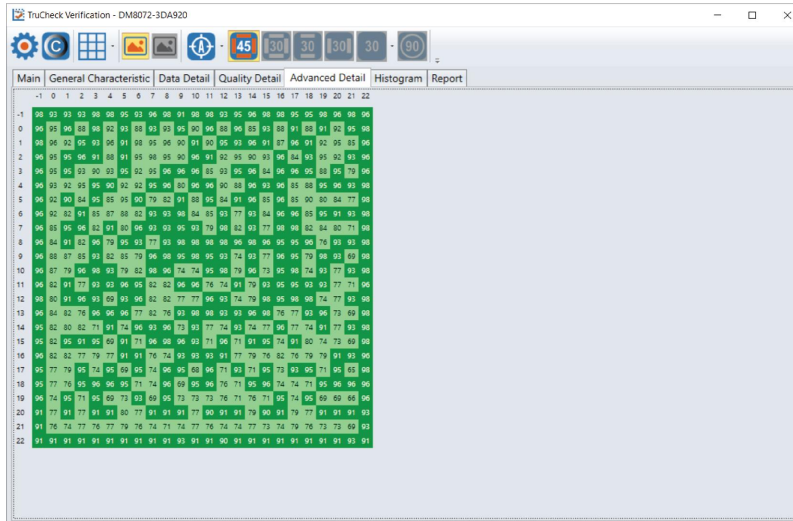

Detailed explanation on modulation calculation can be found in [Grading Standards and their Parameters on page 37](#).

Histogram

The **Histogram** tab shows the analysis of each cell's reflectivity and associated grade.

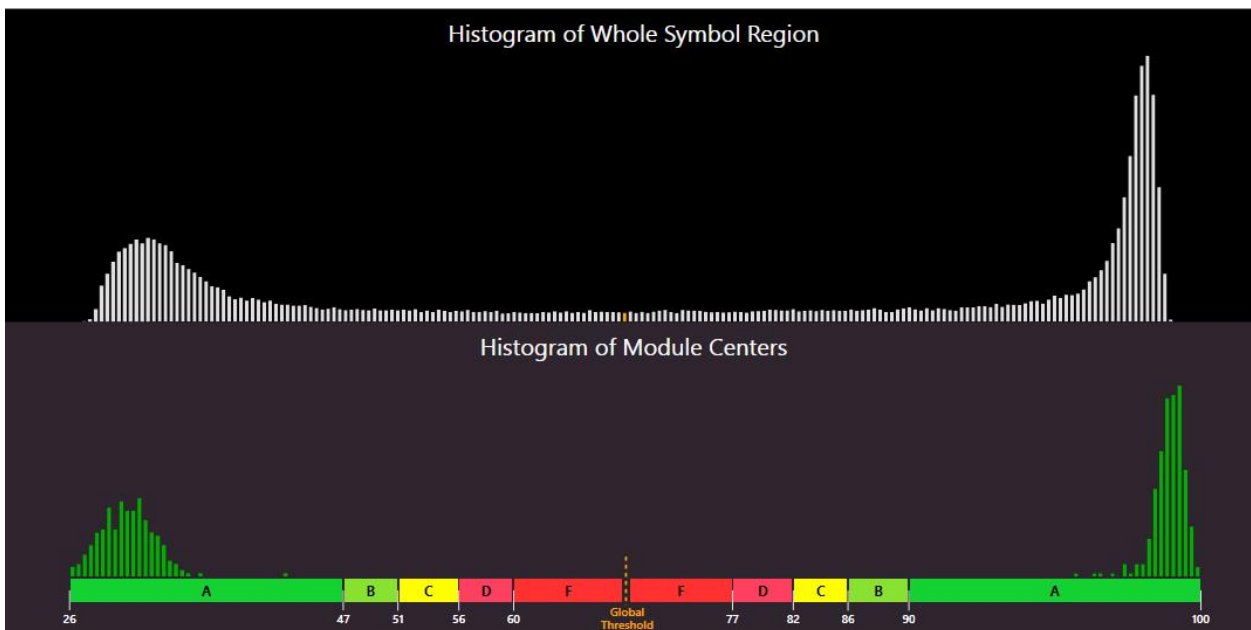

The horizontal axis on the histogram represents the brightness level, with the dark elements on the left and the bright elements on the right. The brighter the element is, the further to the right it will be. The height of each bar represents the number of elements with the brightness associated with its position on the horizontal axis.

The top graph is a histogram representing the brightness of all the pixels in the image. The bottom graph only represents the center of modules in the symbol. As expected, the bottom graph does not contain elements which are not either definitively dark or definitively bright. While all the dark or bright modules are not exactly the same in brightness, they are relatively close to each other and that is why the bars are grouped together. In the upper histogram, some pixels, which are in between dark and bright, are represented. These pixels are typically on the border between dark and light modules and thereby obtain a middle value of brightness.

The horizontal axis contains markers showing the global threshold (tall line) and the separation between B and C, and between C and D modulation levels for both dark and light elements.

Note: When grading according to ISO/IEC TR29158 (AIM-DPM), the histogram is labeled slightly differently. The 0% and 100% labels on the horizontal axis will be located at the means of the dark and light lobes of the histogram and there will be no C level because the DPM grading method uses only A, B, D and F levels for Cell Modulation.

Report

This tab shows a preview of the report:

DataMan DM8070 Verification Report
 Software Version: 5.7.7_a7, Unit Serial: 1A1749XN027031
 Verified: 5/14/2018 10:08:06 AM, Last Calibrated: 5/9/2018 8:09:47 PM
 Page 1 of 1

Report Summary					
Data	F:\01006141419999961750123110123ABC\F1>21MASTER50				
Symbology	GS1 DataMatrix				

Verification Grades					
Standard	Grade	Aperture	Wavelength	Lighting	Formal Grade
ISO15415	A (4.0)	5	660	45	4.0/05/660/45
GS1	Pass				

General Characteristics	
Matrix Size	22x22 (Data: 20x20)
Horizontal BWG	-2%
Vertical BWG	-4%
Encoded characters	44
Total Codewords	50
Data Codewords	30
Error Correction Budget	20
Errors Corrected Used	0
Error Capacity Used	0
Error Correction Type	ECC 200

The contents of the report can be customized to include more or less detail. Customization can be done in the **Reporting Settings** menu, as well as setting options for electronically saving reports and how they are named. This report can be printed and saved electronically.

Note: Adobe PDF™ Reader is required to view the report in the **Report** tab. If the Adobe Reader is not installed, the Report tab will not be present in the TruCheck window, but reports can still be saved as PDFs.

Adobe Settings Change

You need to change security setting to be able to use Adobe with the Verifier.

1. Open **Adobe** -> **Edit** -> **Preferences**.
2. In the **Preferences** menu, select **Security (Enhanced)**.

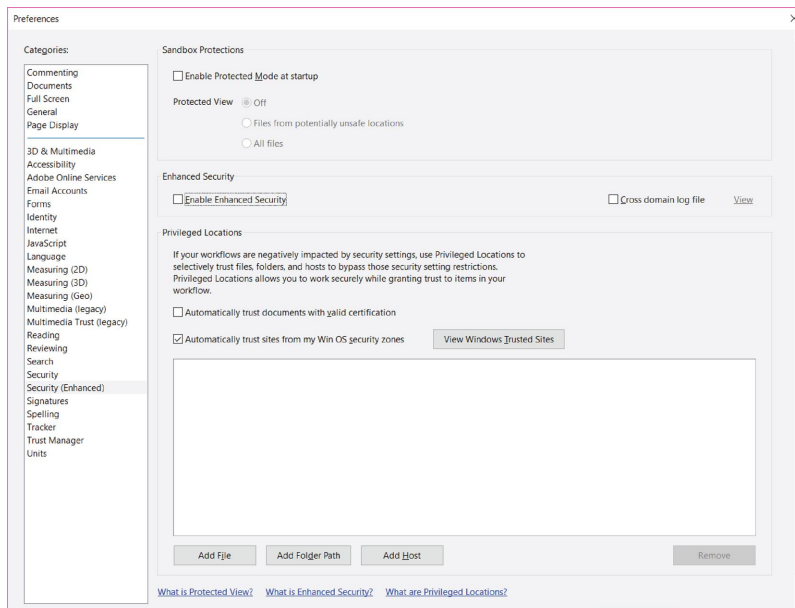





3. Uncheck the box for **Enable Enhanced Security**.
4. Select **OK** to save the change.

User Interface

This section describes the settings and options of the TruCheck Verification window.

Toolbar

Icon	Function
	Settings: Opens up the settings menu allowing changes to be made to the Application Settings, the Reporting Settings and the User Information menu. For more information, see Settings on page 28 .
	Calibration: Opens up the calibration window so that the unit can be calibrated. For more information, see Calibration on page 13 .
	Grid & Modulation Circles: When selected, this applies a grid and/or modulation circles to the image after verification. By using the drop down menu options, you can apply a Real Grid, an Ideal Grid, or both. In addition, you can select to either show Mod Circles Filled or Mod Circles Outlined. When this icon is unselected, neither Grid nor Mod Circles is shown on the image.
	Original Image: Shows the original image used for verification.
	Focusing Indicator: When using the verifier with the optional stand, enabling this feature shows a focusing indicator in the image window that is used to adjust the height of the stand so that the verifier views the target code at the proper focal distance. For more information, see Adjusting the Focus Height on page 24 .

Adjusting the Focus Height

The 8072V Verifier can be equipped with an optional adjustable height stand that is guided by a focus indicator. When using the optional stand, prior to verifying, the verifier must be adjusted to the proper height above the target to ensure proper focus.

Do not use the focusing indicator with the standoff in handheld mode. When used without the stand, the standoff itself is used to achieve the correct focus distance.

Note: If you enable the focus indicator while using the standoff, you might notice that the focus indicator is slightly above or below the target circle. This is because the standoff is nominally at the same height as the stand, but there are slight tolerances. There is some depth of field around the focus height so it can be above or below when it is still in focus.

There is an additional drop-down option under the **Focus Indicator** option. When **View Laser Spot Image** is enabled, the raw image of the focus indicator is shown instead of the found location of the indicator. This may be more useful when using the focusing indicator on certain surfaces.

To adjust the focus, perform the following steps in the TruCheck Verification window:

1. Place the symbol directly under the Verifier and press the **Go Live** button. A live image appears on the screen.
2. When the **Focus Indicator** is enabled, you see a target circle in the center of the image window. Additionally, an image of the indicator spot appears somewhere on the image along the vertical center axis.

Note: It is possible for the indicator spot to fall outside the field of view. In that case, adjust the height of the imager until the indicator spot appears in the image window.

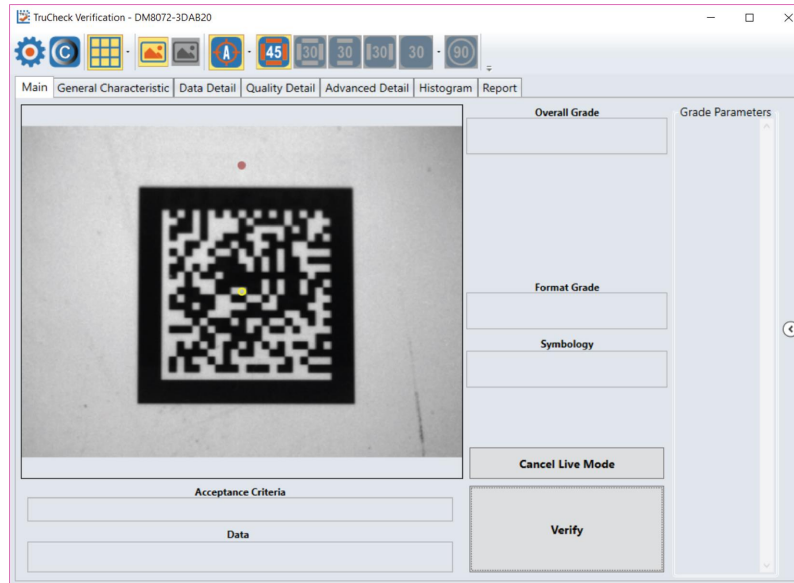

- Carefully rotate the crank on the top of the Verifier until the indicator spot is in the same position as the circle. At this point the circle turns green, indicating that the unit is in focus.

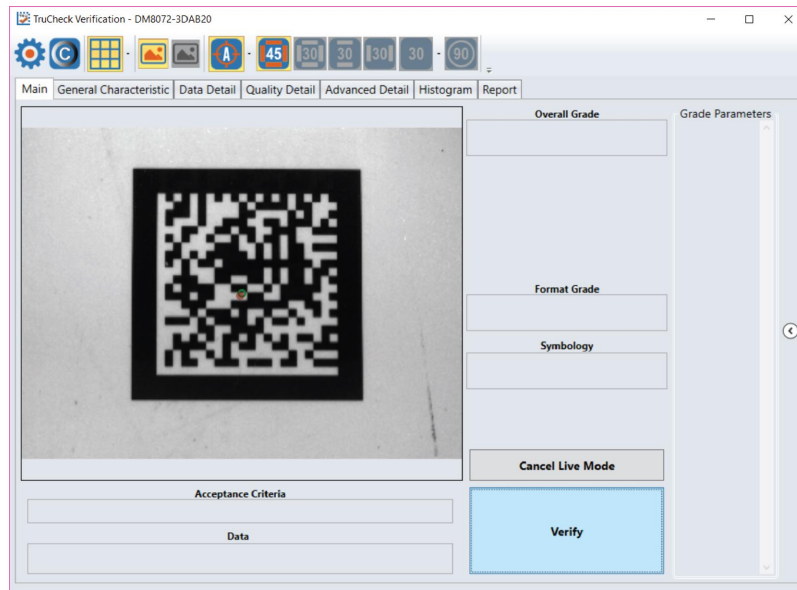

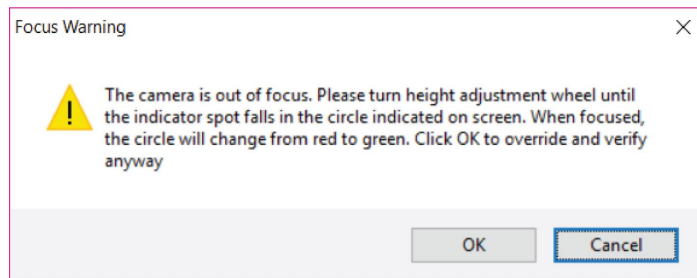

If you attempt to verify when the target circle is not green, you are prompted to focus by a **Focus Warning** pop-up window. By clicking the **OK** button, you have the option to override the focus indicator requirement in cases when the indicator spot is physically blocked by a part of a real object on which a code is to be verified. Always set the correct focus position first and only click the **OK** button if you are instructed to do so.





Illumination Icons

Direct Part Mark (DPM) verifiers have multiple lighting options to grade according to various grading methodologies and standards (such as AIM-DPM). When verifying using ISO15415, only the 45Q lighting option is available for selection; when verifying using ISO 29158 (AIM-DPM), all lighting options are available for selection.

Note: Some lighting options are not allowed in some application standards. Only select options that provide you with a result that is valid for your application. It is common to use AIM-DPM as the basis for grading when working with DPM symbols and lighting other than 45-degree light from four sides.

Icon	Function
	This icon selects 45° illumination. 45° four-sided illumination is used primarily for labels. This illumination is either not reported or is reported as 45Q. (If illumination is not reported, it is assumed to be 45Q).
	This icon selects 30° illumination from four sides. It may reduce glare from some substrates, which cause poor Symbol Contrast or Modulation grading. This illumination is reported as 30Q and is used primarily for DPM applications.

Icon	Function
	<p>These icons select 30° two-sided illumination. This illumination can be from either the North/South or East/West. These are useful on cylindrical surfaces. Select them parallel to the axis of the cylinder. This illumination is reported as 30T.</p>
	<p>This icon selects one side of the 30° lighting to be used. Use the drop down menu to select one of the four sides for 30° lighting. If you select this lighting option but you do not select any individual lighting side, the top 30° lighting is used. This illumination is reported as 30S.</p>
	<p>This icon selects 90° diffuse illumination and works well on very shiny substrates and Dot Peen Applications. This illumination is reported as 90.</p>

Settings

This section describes the settings you can make and the options you have in the TruCheck Verification window.

Accessing the Settings Menu

To access Settings, select the Settings icon in the upper left hand corner of the interface.

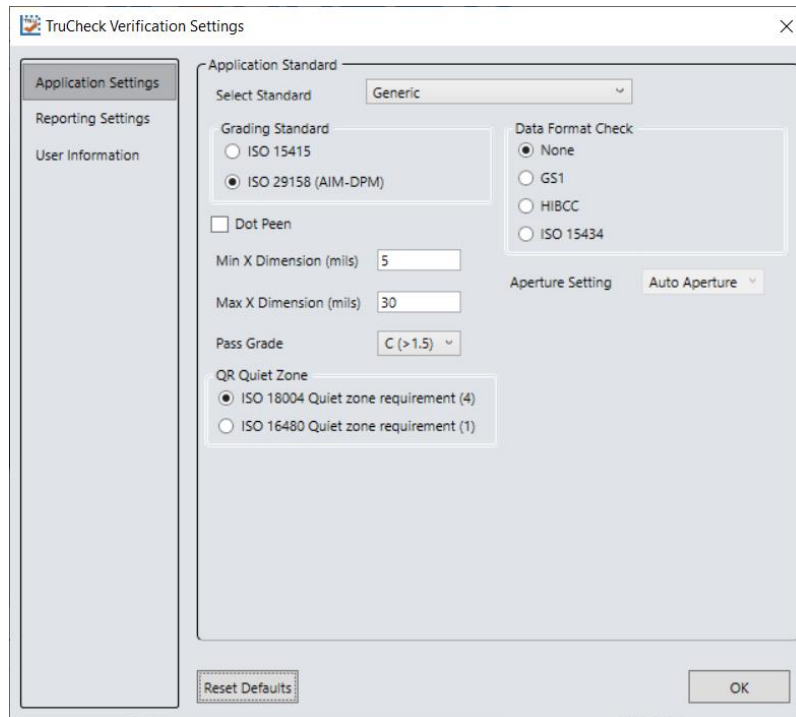

Application Settings

The contents of the Application Settings window depend on the Application Standard that you select. This is because the application standard automatically selects many parameters. The **Generic** application standard allows you to select all adjustable verification and process parameters in a custom way. Selecting a pre-defined application standard ensures that the Verifier uses the appropriate grading parameters for your application. For example, when using pre-defined application standards, you do not need to specify an Aperture Size because it is always chosen in accordance with the application standard automatically.

The **Reset Defaults** button resets the Application Settings menu to default settings. After clicking **Reset Defaults**, you must calibrate the Verifier prior to use.

Application Standards Settings

Application standards configure the Verifier to grade according to pre-defined rules established by an industry standards body (such as GS1) or other industry requirements such as MIL-STD 130 (UID).

Specify the application standard by selecting one of the options provided in the drop down box.

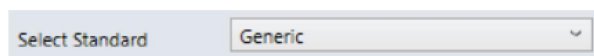

You have the following setting options available within each of these standards:

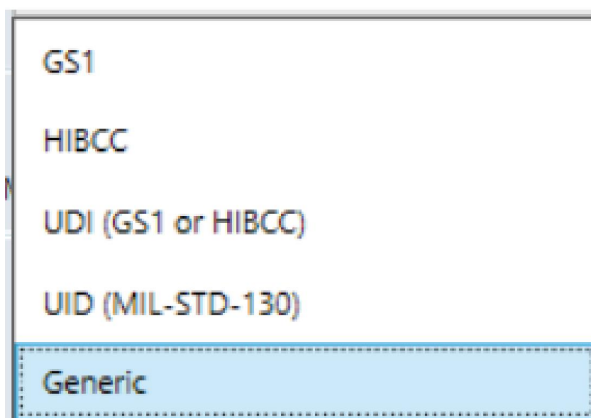

GS1

The GS1 Application standard allows codes to be verified according to GS1 General Specifications. GS1 General Specifications contain several categories of applications which are described in its Tables 1-11. You can select from among these tables to specify the application category for your codes. Consider the following examples:

- If you are printing for point of sale (POS) applications, Table 1 is applicable to your codes.
- If you are printing UDI barcodes, Table 6 is applicable to your codes.
- If you are unsure of which table to choose, opt for **Auto (Warn if Ambiguous)**. When using the Auto option, the verifier determines one or more applicable tables based on the X-dimension of the decoded symbol and the grading standard (ISO/IEC 15415 or ISO/IEC 29159 (AIM DPM)). The report indicates the table that was selected. If more than one table is applicable, the Verifier gives a warning when the information is ambiguous and lists the tables that are applicable. It chooses the most likely table to be applied, and identifies the table that was applied in the report.

Note: Since the X-dimension of the decoded symbol is used to deduce which table applies, it may be incorrect if your X-dimension is outside of the range allowed in your application. To be sure that the Verifier is checking all of the proper requirements for your application, select the Table in the GS1 General Specifications that apply to your application.

The GS1 table used is reported in the **Notes** section of the report. Refer to the tables provided in the *GS1 General Specifications Standard* for more information on the tables used for analysis.

In addition to which Table of the GS1 General Specifications to use, you can also specify ISO/IEC 15415 grading (generally used for labels) or ISO/IEC 29158 (AIM-DPM) as the grading method.

The image shows the 'TruCheck Verification Settings' dialog box. On the left, there is a sidebar with three options: 'Application Settings' (selected), 'Reporting Settings', and 'User Information'. The main area is titled 'Application Standard' and contains the following settings:

- 'Select Standard' is a dropdown menu set to 'GS1'.
- 'Grading Standard' has two radio buttons: 'ISO 15415' (unselected) and 'ISO 29158 (AIM-DPM)' (selected).
- 'Dot Peen' is an unchecked checkbox.
- 'Auto (Warn if Ambiguous)' is a dropdown menu.
- 'QR Quiet Zone' has two radio buttons: 'ISO 18004 Quiet zone requirement (4)' (selected) and 'ISO 16480 Quiet zone requirement (1)' (unselected).
- At the bottom of the main area is a text box containing the text 'Automatically Determine which GS1 Table to be used'.

At the bottom of the dialog box, there are two buttons: 'Reset Defaults' on the left and 'OK' on the right.

MIL-130-STD UID

This application standard properly reports the quality standard used to grade the code and the data structure used in (Construct 1 or Construct 2) for UID marks specified in MIL-STD 130. The MIL-STD spells out acceptable grades and requirements for data format.

You must specify either ISO 15415 grading or ISO 29158 (AIM-DPM) grading.

Select **Dot Peen** if it is applicable.

The image shows the 'TruCheck Verification Settings' dialog box with the 'Application Standard' settings updated for MIL-130-STD UID. The settings are as follows:

- 'Select Standard' is a dropdown menu set to 'UID (MIL-STD-130)'.
- 'Grading Standard' has two radio buttons: 'ISO 15415' (unselected) and 'ISO 29158 (AIM-DPM)' (selected).
- 'Dot Peen' is an unchecked checkbox.
- 'QR Quiet Zone' has two radio buttons: 'ISO 18004 Quiet zone requirement (4)' (selected) and 'ISO 16480 Quiet zone requirement (1)' (unselected).

At the bottom of the dialog box, there are two buttons: 'Reset Defaults' on the left and 'OK' on the right.

UDI/HIBC

This application standard checks symbols that meet UDI requirements using either GS1 or HIBCC guidelines.

You must specify either ISO 15415 grading or ISO 29158 grading.

Select **Dot Peen** if it is applicable.

Since the data content required for UDI compliance varies depending on the medical device, only the data format (but not what content is present or missing) is validated. Data is automatically validated in accordance with GS1 formatting rules or in accordance with HIBCC formatting rules.

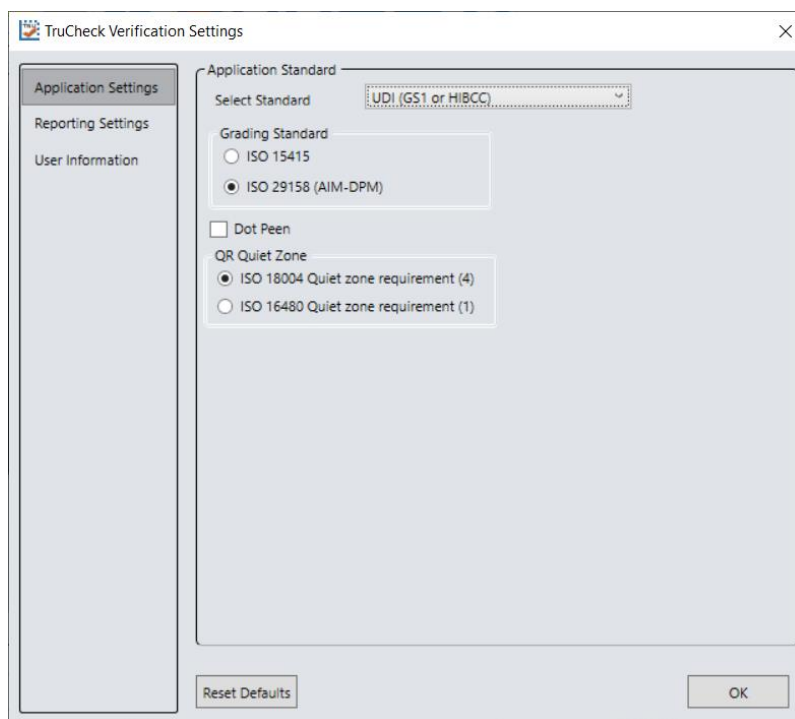

Generic

Apply the Generic standard option when you are grading a code that is not expected to adhere to any pre-defined industry conformance standard, and so it can be customized with specific settings for:

- Aperture Size
- Minimum Acceptable Pass Grade
- Minimum and Maximum X-dimension
- Grading Method: ISO 15415 or ISO 29158

- Data Parsing and Validation

The screenshot shows the 'TruCheck Verification Settings' dialog box. On the left, there are three tabs: 'Application Settings' (selected), 'Reporting Settings', and 'User Information'. The main area is titled 'Application Standard' and contains the following settings:

- Select Standard:** A dropdown menu showing 'Generic'.
- Grading Standard:** Radio buttons for 'ISO 15415' and 'ISO 29158 (AIM-DPM)'. 'ISO 29158 (AIM-DPM)' is selected.
- Dot Peen:** An unchecked checkbox.
- Min X Dimension (mils):** A text input field containing '5'.
- Max X Dimension (mils):** A text input field containing '30'.
- Pass Grade:** A dropdown menu showing 'C (>1.5)'.
- Data Format Check:** Radio buttons for 'None', 'GS1', 'HIBCC', and 'ISO 15434'. 'None' is selected.
- Aperture Setting:** A dropdown menu showing 'Auto Aperture'.
- QR Quiet Zone:** Radio buttons for 'ISO 18004 Quiet zone requirement (4)' and 'ISO 16480 Quiet zone requirement (1)'. 'ISO 18004 Quiet zone requirement (4)' is selected.

At the bottom of the dialog, there are two buttons: 'Reset Defaults' and 'OK'.

Grading Standards

For any Application Standard selected, you must choose to use either ISO 15415 or ISO 29158 (AIM-DPM) depending on your application.

- **ISO 15415:** Reports and displays according to ISO/IEC 15415 which is typically used for label based codes.
- **ISO 29158 (AIM-DPM):** Select this if you want to use the AIM-DPM verification standard. This can be used with or without the Dot Peen selection. When using AIM-DPM Grading, the X-Dimension Range is used instead of the aperture setting in accordance with the AIM-DPM methodology.

Data Format Check

You can apply a specific **Data Format Check** criteria to the data content of the code or leave the option as **None**. If a specific Data Format Check is applied, a Data Format Check grading box appears on the main screen of the User Interface to show the Pass/Fail grade provided. In addition, a Data Format Check table is provided on the report showing more detailed parsing information.

- **GS1:** This option checks the format of the data against GS1 formatting rules. These codes generally begin with a Function 1 <F1> character.
- **HIBCC:** This option checks the format of the data against HIBCC formatting rules. These codes generally begin with a + character.

- **ISO/IEC 15434**: This option checks data for many industry standards which encode information using ISO/IEC 15434 data structures. These codes generally begin with the sequence `]]><RS>nn<GS>` where `nn` are two digits which are typically 05, 06 or 12. MIL-STD 130 and some shipping container applications use this formatting style

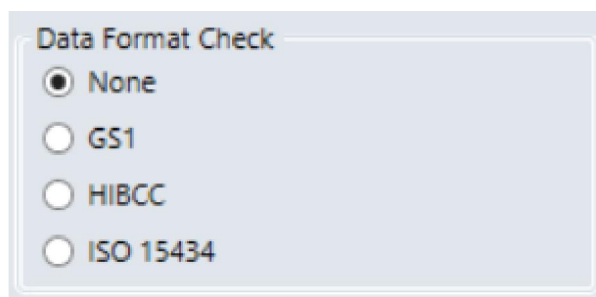

Data Format Check

None

GS1

HIBCC

ISO 15434

Dot Peen

Use this option for codes created with the dot peening process, which is a process where dots are peened onto a metal surface. Select **Dot Peen** to use the AIM-DPM Stick algorithm to connect dots.

Min X-Dimension (mils)

You can set a minimum x-dimension value that is allowed during verification. The lowest value that can be set is 1 mil. Any code that falls below the minimum x-dimension set receives a grade of FAIL (X Dimension out of Range). If no minimum x-dimension is specified, the application defaults to 5 mils.

Max X-Dimension (mils)

You can set a maximum x-dimension value that is allowed during verification. The highest value that can be set is 100 mils. Any code that is above the maximum x-dimension set receives a grade of FAIL (X Dimension out of Range). If no maximum x-dimension is specified, the application defaults to 30 mils.

Pass Grade

Select a minimum passing grade based on a certain letter or numerical value (that is, $C > 1.5$). Any code verified that does not receive an Overall Grade above the Pass Grade minimum set receives a grade of Fail for Pass Grade on the User Interface and Report.

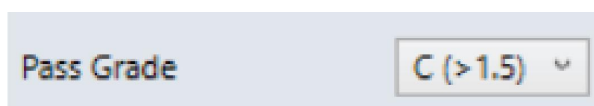

Pass Grade

C (>1.5) ▾

QR Quiet Zone

A selection can be made to use either ISO 18004 Quiet zone requirements of a 4 module-sized quiet zone or ISO 16480 Quiet Zone Requirement of a 1 module-sized quiet zone.

Aperture Setting

This is the size of the synthetic aperture used to produce the blurred reference image that is an integral part of ISO 15415 grading. Choose the size of the aperture with care because it has a profound effect on the grade, according to the requirements of your application. In general, larger aperture sizes reduce the sensitivity to defects in printing, but also reduce the ability to resolve small elements in a code. Consequently, the size of the aperture is limited by the X-dimension of your symbols, or conversely the X-dimension of your symbols is limited by the size of your aperture. Aperture size can be called out in the application specification, quality specification, or both. If you are unsure of the aperture size to select, choose **Auto** and the Verifier uses guidance supplied within ISO 15415 to choose an aperture size based on the X-dimension of the code.

The aperture setting is used when grading in accordance with ISO/IEC 15415, but it is not used when grading in accordance with AIM-DPM. While AIM-DPM grading does include a blurred reference image, just like ISO 15415, the aperture size is dictated by the AIM-DPM grading method to be either 50% or 80% of the symbol X-dimension automatically.

You must specify an aperture size for the Generic standard when using ISO/IEC 15415.

In the drop down menu, select one of the following:

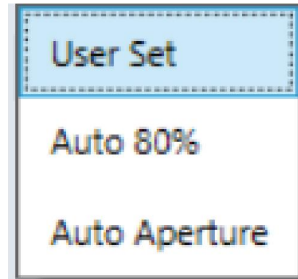

User Set

The application allows you to specify the aperture setting. When **User Set** is selected, an additional drop down menu pops up for you to select the correct aperture.

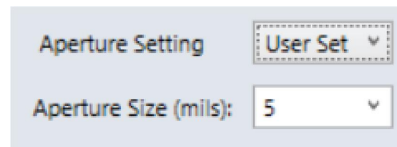

Auto 80%

The application automatically chooses an aperture size based on 80% of the x-dimension.

Auto Aperture

The application automatically chooses an aperture size based on the X-dimension in accordance with the suggestion in ISO/IEC 15415. For more information, see the table below.

X-Dimension	Aperture
Less than 6 mil	02 (2 mil)
6 mil to 7.5 mil	03 (3 mil)
7.5 mil to 10 mil	05 (5 mil)
10 mil to 20 mil	08 (8 mil)
20 mil to 30 mil	16 (16 mil)
More than 30 mil	20 (20 mil)

Note: AIM-DPM grading (ISO/IEC TR 29158) always selects an aperture automatically based on the X- Dimension of the decoded symbol, which overrides the above rules. These rules only apply to ISO/IEC 15415 grading when **Auto Aperture** is selected.

Reporting Settings

Report Preview: This section shows a preview of the report that will be generated after verification. By selecting or unselecting boxes in Report Sections, the information shown on the report preview will adjust to reflect the changes made to what information is shown in the report.

Report Sections: These are the selections that determine what optional sections are printed (or saved in PDF files) on the reports. This information will appear on the various tabs in the User Interface for viewing, regardless of what selection is made.

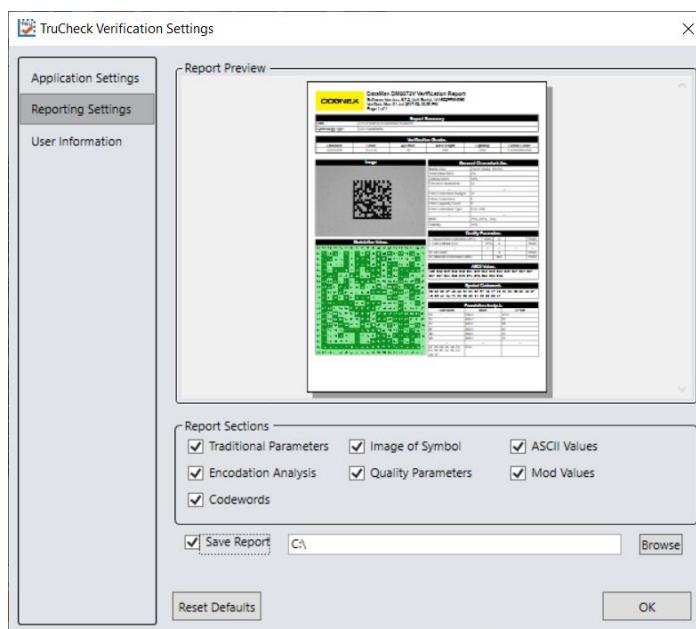

Traditional Parameters: Includes Minimum Reflectance Difference (MRD) in the reported General Characteristics both in the verification report and on the User Interface. MRD quantifies the minimum difference anywhere across the barcode. This information is also found in the General Characteristic tab.

Encodation Analysis: Turns on the reporting of Decoded characters or “codewords” to final output text which can be useful when encoding errors are present in a 2D symbology. This information is also found on the Data Detail tab.

Codewords: Turns on reporting of the codeword that are directly encoded in the 2D symbol. Codewords which were correcting by error correction are indicated. This information is also found on the Data Detail tab.

Image of Symbol: Includes the image used for verification on the verification report. This information is also found on the General Characteristic tab.

Quality Parameters: Enables reporting of a standard’s quality parameters and their corresponding values and grades. Selecting this is highly recommended, as this information makes visible the reasons for poor results in a standard. This information is also found on the Quality Detail tab.

ASCII Values: Turns on the reporting of the encoded ASCII values. This does not affect how unprintable characters are represented in the decoded data on reports, which is done by a special ASCII Code Representation, for example <CR> for carriage return which is ASCII value 13. This information is also found on the Data Detail tab. See the ASCII Values Table

- **Decoded Data ASCII Code Representation for unprintable characters:** Some barcode can encode ASCII characters that are unprintable and therefore difficult to represent in the printed reports. A special pattern is used to represent these characters using a consistent notation of two letters, which represents the ASCII code, surrounded by brackets.

Reports will show unprintable ASCII values using the following notation:

ASCII Code Value (decimal)	ASCII Code name	Special Pattern Used
0	NULL	<NU>
1	SOH	<SH>

ASCII Code Value (decimal)	ASCII Code name	Special Pattern Used
2	STX	<ST>
3	ETX	<ET>
4	EOT	<EO>
5	ENQ	<EN>
6	ACK	<AC>
7	BEL	<BE>
8	BS	<BS>
9	HT	<HT>
10	LF	<LF>
11	VT	<VT>
12	FF	<FF>
13	CR	<CR>
14	SO	<SO>
15	SI	<SI>
16	DLE	<DL>
17	DC1	<D1>
18	DC2	<D2>
19	DC3	<D3>
20	DC4	<D4>
21	NAK	<NK>
22	SYN	<SY>
23	ETB	<EB>
24	CAN	<CA>
25	EM	
26	SUB	<SU>
27	ESC	<ES>
28	FS	<FS>
29	GS	<GS>
30	RS	<RS>
31	US	<US>

Note: The special patterns always consist of two letters, even though the name of the ASCII code sometimes contains more than two characters (example EOT, BEL, etc.). This is to preserve regular column spacing in the printed reports and to make it easier to parse the data strings.

Mod Values: Reports show the individual modulation values from each data cell in the symbol. This information is also found on both the Data Detail and Advanced Detail tabs.

Save Report: Saves reports electronically to the path defined in the field. Use the Browse button to select the pathway to save the report. The path can be a local hard drive or file server the user when has permission to write to it. The Reporting Settings selected, as described above, determine what information is contained in the save reports.

Save Report

Reset Defaults: Selecting the Reset Defaults button will reset the Settings menu to the default settings. After clicking on the Reset Defaults button, the verifier must be recalibrated prior to use.

Grading Standards and their Parameters

ISO/IEC 15415 Grading Parameters

- **UEC (Unused Error Correction):** This is the percentage of error correction capability that is available for further incorrect modules. The assignment of grade is according to the following table:

UEC %	Grade
> 62	A (4.0)
> 50 (but less than 62)	B (3.0)
> 37 (but less than 50)	C (2.0)
> 25 (but less than 37)	D (1.0)
< 25	F (0)

- **SC (Symbol Contrast):** This is the difference in reflectivity between the brightest module and the darkest module. The assignment of grade is according to the following table:

SC%	Grade
> 70	A (4.0)
> 55 (but less than 70)	B (3.0)
> 40 (but less than 55)	C (2.0)
> 20 (but less than 40)	D (1.0)
< 20	F (0)

- **MOD and RM (Modulation):** This is a grade based on the amount of variability in reflectivity of the modules. A multi-step process is used to get the modulation grade. First, the reflectivity of each module is compared to the global threshold and the overall symbol contrast according to the following formula:

$$\text{MOD} = 2 * (\text{abs}(R - \text{GT})) / \text{SC}$$

The Global Threshold GT is the midpoint between the reflectance of the brightest module and the reflectance of the darkest module. Next, the grade level for each module is determined from the MOD value according to the following table:

MOD %	Grade
> 50	A (4.0)
> 40 (but less than 50)	B (3.0)
> 30 (but less than 40)	C (2.0)
> 20 (but less than 30)	D (1.0)
< 20	F (0)

Finally, the value of the grade for the Modulation parameter will be the highest modulation level for which the modules meeting that level will result in a notional Unused Error Correction grade of that level or higher. The module with the lowest MOD is reported as Contrast Uniformity (CU) in General Characteristics to facilitate conformance testing to the requirements of ISO/IEC 15426-2.

The RM parameter works in a similar way, except that for modules which were corrected as errors by error correction, the MOD% is taken as 0 and counts as F in the final evaluation of the Modulation parameter grade according to the notional Unused Error Correction grade.

- **ANU (Axial Non-uniformity):** This is the amount of “out of square” the modules are or in other words, a measure of the overall aspect ratio of the symbol. Note that for rectangular symbols which are supposed to be non-square, the ANU parameter reports the deviation from its “correct” aspect ratio.

ANU %	Grade
≤ 6	A (4.0)
< 8 (but more than 6)	B (3.0)
< 10 (but more than 8)	C (2.0)
< 12 (but more than 10)	D (1.0)
> 12	F (0)

- **GNU (Grid Non-uniformity):** This is the worst-case distance between the calculated center of a module and the ideal location for the center of the module based on perfectly evenly spaced modules. The calculated center of the module is determined using clock track edges in accordance with the reference decode algorithm. The value is reported as a percentage of a module size.

GNU %	Grade
≤ 38	A (4.0)
< 50 (but more than 38)	B (3.0)
< 63 (but more than 50)	C (2.0)
< 75 (but more than 63)	D (1.0)
> 75	F (0)

- **FPD (Fixed Pattern Damage):** This is the overall grade for all the fixed pattern components. This grade is equal to the lowest grade of all the components listed below. The following is a list of components of the finder pattern for Data Matrix symbols. For QR Code symbols, the parameters described in [ISO 18004 QR Code Grading Parameters on page 1](#) are applicable.
- **LLS (Left ‘L’ Side):** This is a grade based on imperfections in the left ‘L’ side of the finder pattern. There are two checks required to pass. The first requires gaps to be three modules or less and that gaps are separated by stretches of at least four correct modules. The second assigns a grade based on the overall percentage of correct modules according to the following table:

% of incorrect modules	Grade
0	A (4.0)
< 9 (but more than 0)	B (3.0)
< 13 (but more than 9)	C (2.0)
< 17 (but more than 13)	D (1.0)
> 17	F (0)

The grade is the highest modulation level in which the first (gap test) passes and the correct module percentage results in a grade of that level or higher.

- **BLS (Bottom ‘L’ Side):** This is a grade based on imperfections in the bottom ‘L’ side of the finder pattern (see Left ‘L’ Side).
- **LQZ (Left Quiet Zone):** This is a grade based on imperfections in the quiet zone, which is a one-module area to the left of the left ‘L’ side. The grade is based on the percentage of modules, which are correct using the same grading table as for the ‘L’ sides.

- **BQZ (Bottom Quiet Zone):** This is a grade based on imperfections in the quiet zone, which is a one-module area below the bottom 'L' side.
- **TQZ (Top Quiet Zone):** This is a grade based on imperfections in the quiet zone, which is a one-module area above the top clock track.
 - **ULQZ (Upper Left Quiet Zone):** This is the top quiet zone above the upper left quadrant (Used only for 2 and 4 quadrant symbols, this is the grade based on the segment of the quiet zone above the top clock track of the left quadrant).
 - **URQZ (Upper Right Quiet Zone):** This is the top quiet zone above the upper right quadrant (Used only for 2 and 4 quadrant symbols, this is the grade based on the segment of the quiet zone above the top clock track of the right quadrant).
- **RQZ (Right Quiet Zone):** This is a grade based on imperfections in the quiet zone, which is a one-module area to the right of the Right Clock Track.
 - **RUQZ (Right Quiet Zone to the right of the upper right quadrant):** Only for 2 and 4 quadrant symbols, this is the grade based on the segment of the quiet zone to the right of the upper right quadrant.
 - **RLQZ (Right Quiet Zone to the right of the lower right quadrant):** Only for 4 quadrant symbols, this is the grade based on the segment of the quiet zone to the right of the lower left quadrant.
- **TTR (Top Transition Ratio):** This is a grade based on imperfections in the top clock track, with relation to its adjoining quiet zone. The ratio is the number of transitions from light to dark or dark to light in the quiet zone divided by the number of transitions in the clock track. Since the number of transitions in the quiet zone should be zero, the ideal value for this parameter is zero. However, a small number of transitions can be tolerated as long as the ratio remains relatively low. As the number of teeth in the clock track increases (larger symbols) more transitions in the quiet zone can be tolerated. Also, more transitions in the clock track (which are really imperfections) will tend to improve this measurement. The grading scheme for this transition ratio is:

Transition Ratio %	Grade
< 6	A (4.0)
< 8 (but more than 6)	B (3.0)
< 10 (but more than 8)	C (2.0)
< 12 (but more than 10)	D (1.0)
> 12	F (0)

The value of the grade will be the highest modulation level for which the ratio gives a grade from the above table of that modulation level or higher.

- **ULQTTR (Transition ratio for Upper Left Quadrant Top Clock Track):** Only for 4 quadrant symbols, this is the grade based on the clock track segment at the top of the upper left quadrant. For a 2 quadrant symbol, this will be labeled LQTTR.
- **URQTTR (Transition ratio for Upper Right Quadrant Top Clock Track):** Only for 4 quadrant symbols, this is the grade based on the clock track segment at the top of the upper right quadrant. For a 2 quadrant symbol this will be labeled RQTTR.
- **LLQTTR (Transition ratio for Lower Left Quadrant Top Clock Track):** Only for 4 quadrant symbols, this is the grade based on the clock track segment at the top of the lower left quadrant.
- **LRQTTR (Transition ratio for Lower Right Quadrant Top Clock Track):** Only for 2 and 4 quadrant symbols, this is the grade based on the clock track segment at the top of the lower right quadrant.

RTR (Right Transition Ratio): Transition ratio (see Top Transition Ratio) for the right clock track in relation to the right quiet zone

- **.ULQRTR (Transition ratio for Upper Left Quadrant Right Clock Track):** Only for 2 and 4 quadrant symbols, this is the grade based on the clock track segment to the right of the upper left quadrant. For a 2 quadrant symbol, this will be labeled LQRTR
 - **URQRTR (Transition ratio for Upper Right Quadrant Right Clock Track):** Only for 2 and 4 quadrant symbols, this is the grade based on the clock track segment to the right of the upper right quadrant. For 2 quadrant symbols, this will be labeled RQRTR.
 - **LLQRTR (Transition ratio for Lower Left Quadrant Right Clock Track):** Only for 4 quadrant symbols, this is the grade based on the clock track segment to the right of the lower left quadrant.
 - **LRQRTR (Transition ratio for Lower Right Quadrant Right Clock Track):** Only for 4 quadrant symbols, this is the grade based on the clock track segment to the right of the lower right quadrant.
- **TCT (Top Clock Track):** This is a grade based on imperfections in the top clock track. Some imperfections in the clock track can be tolerated. However, the rule that must be maintained for a passing grade is that three out of every five modules (on a consecutively rolling window of five modules) must be correct. The value of the grade will be the highest modulation level for which this test passes.
 - **ULQTCT (Top Clock Track for Upper Left Quadrant):** Only for 2 and 4 quadrant symbols, this is the grade based on the clock track segment at the top of the upper left quadrant. For 2 quadrant symbols this will be labeled LQTCT.
 - **URQTCT (Top Clock Track for Upper Right Quadrant):** Only for 2 and 4 quadrant symbols, this is the grade based on the clock track segment at the top of the upper right quadrant. For 2 quadrant symbols this will be labeled RQTCT.
 - **LLQTCT (Top Clock Track for Lower Left Quadrant):** Only for 4 quadrant symbols, this is the grade based on the clock track segment at the top of the lower left quadrant.
 - **LRQTCT (Top Clock Track for Lower Right Quadrant):** Only for 4 quadrant symbols, this is the grade based on the clock track segment at the top of the lower right quadrant.
- **RCT (Right Clock Track):** This is a grade based on imperfection in the right clock track (see Top Clock Track).
 - **ULQRCT (Right Clock Track for Upper Left Quadrant):** Only for 2 and 4 quadrant symbols, this is the grade based on the clock track segment to the right of the upper left quadrant. For 2 quadrant symbols, this will be labeled LQRCT.
 - **URQRCT (Right Clock Track for Upper Right Quadrant):** Only for 2 and 4 quadrant symbols, this is the grade based on the clock track segment to the right of the upper right quadrant. For 2 quadrant symbols, this will be labeled RQRCT.
 - **LLQRCT (Right Clock Track for Lower Left Quadrant):** Only for 4 quadrant symbols, this is the grade based on the clock track segment to the right of the lower left quadrant.
 - **LRQRCT (Right Clock Track for Lower Right Quadrant):** Only for 4 quadrant symbols, this is the grade based on the clock track segment to the right of the lower right quadrant.

- **AG (Average Grade of Damage across many parts of the Finder Pattern):** This is a grade that considers the accumulated effect of damage to several parts of the finder pattern. Five values are averaged together. One of these is the lowest of all the grades associated with all the clock track segments, namely TCT, TTR, TQZ and RCT, RTR, RQZ. The other four are LLS, BLS, LQZ, and BQZ. The average must fall in the range of 0.0 through 4.0 and is given a grade according to the following:

Ave Grade	Grade
Equals 4.0	A (4.0)
≥ 3.5 (but less than 4.0)	B (3.0)
≥ 3.0 (but less than 3.5)	C (2.0)
≥ 2.5 (but less than 3)	D (1.0)
< 2.5	F (0)

Note: The effect of the AG parameter is to lower the overall grade of symbols, which have several individual parameters at or near the same level. For instance, with enough B grades in individual parameters, the overall grade may come out as a C grade rather than a B.

- **DECODE:** Report whether the 2D Symbol was decoded in accordance with the reference decode algorithm with the specified aperture.

Note: It is possible for decoded results to be reported, but for a failure to occur when decoding in accordance with the reference decode algorithm. In this case, the DECODE grade will be F (0).

Contrast Uniformity (CU): This is the value of MOD (modulation) for the worst case module selected from a 2D Matrix symbol. This is useful for process control, as way of measuring the drift in reflectivity consistency, and more importantly for testing conformance to ISO/IEC 15426-2 which requires the modulation of a specific module within a conformance test symbol to be reported. This parameter is not graded, nor listed in the Quality Detail tab. Rather, it is reported in General Characteristics.

ISO 29158 (AIM-DPM) 2006 Grading Parameters

The ISO 29158 (AIM-DPM) method of grading Data Matrix symbols modifies the process of ISO-15415 and is more appropriate for direct part marking applications. This standard was developed to be more representative of the scanning performance of modern readers that in some cases are specifically designed for these demanding applications. In this method, the image brightness is adjusted to produce an image of the symbol that fills most or all of the dynamic range of the imager, resulting in an image that is easier to see. Additionally, the threshold between dark and light is calculated from the statistics of the image brightness histogram. Thus, the measurements calculated by AIM-DPM differ from those of ISO 15415 significantly. Some of the parameters reported in ISO 15415 are changed so drastically that to remove the possibility of confusion between these two methods, the parameters have been renamed. These parameters are:

AIM-DPM Parameter Name	ISO 15415 Parameter Name	Summary of Change(s)
CC (Cell Contrast)	SC (Symbol Contrast)	Made relative to light background.
CM (Cell Modulation)	MOD (Modulation)	Threshold calculated from statistics rather than the maximum and minimum reflectance. Grading scale range set to Mean of distribution, rather than maximum and minimum reflectance.
DD (Distributed Damage)	AG (Average Grade)	Modulation overlay uses only A, B, D, and F levels instead of A, B, C, D, and F.
MR (Minimum Reflectance)	Not necessary, since SC is measured on an absolute scale.	An absolute limit on SC of 5% added to temper the relative nature of CC and “catch” extremely low contrast symbols.

All of the Fixed Pattern Damage grading (other than AG shown above) are not renamed, but are functionally different since the global threshold and modulation grading scale are different. In general, symbols will obtain a significantly higher grade according to AIM-DPM than ISO 15415. Therefore, grading according to AIM-DPM is appropriate only when called for in an application specification.

Another significant difference is the allowance for a variety of illumination options. These include the four-sided 45° light that is the default for ISO 15415. Additional lighting angles allowed are 30° lighting from four sides, 30° from two sides (which can be either North/South or East/West), 30° from one side, and 90° diffuse on-axis lighting. The light source that is used is reported using a notation that includes the angle, and a letter (Q for 4, T for two, S for single).

AIM-DPM also varies the size of the aperture until the symbol is decoded, and then the grading is repeated with two different aperture sizes (50% and 80%) and the better of the two grades is reported as the final grade. Note that when the reference decode algorithm fails to decode a symbol with both 50% and 80% aperture, the DECODE grade will be “F” and a note will be printed on the grade section of the report, even if the symbol is recognized and decoded with a different aperture size in an earlier phase of the grading procedure.

The parameters, which are new or significantly modified for AIM-DPM, are explained below:

- **CC (Cell Contrast):** This is the relative contrast value between bars and spaces, taken from the means of the light and dark element $CC = (L_{mean} - D_{mean}) / L_{mean}$.

CC%	Grade
≥ 30%	4
≥ 25%	3
≥ 20%	2
≥ 15%	1
< 15%	0

- **CMOD (Cell Modulation):** Similar to MOD in ISO 15415, this parameter measures the deviation in the reflectivity of dark and light elements. A range for each group (light and dark) is created from the global threshold to the mean reflectance of the elements. Each module is graded along this range, then error correction capability is considered to “discount” the effect of one or a few elements with low values, and a final grade for this parameter is computed.
- **DDG (Distributed Damage Grade):** Similar to AG in ISO 15415, this parameter takes into account the effect of multiple segments of the fixed pattern having imperfections. Where multiple segments have a low grade, the effect of this “distributed damage” is reflected in a lower grade for DDG than the lowest of the individual segments.
- **MR (Minimum Reflectance):** This is a requirement for at least 5% reflectance difference between light and dark elements, as a restraint on the purely relative CC parameter.
- **Decode:** Decode grade A or F depending upon whether the reference decode algorithm succeeds in decoding the symbol with the required final aperture size.

Traditional (Non-Graded) Parameters

PCS

Ways of Quantifying Contrast: Print Contrast Signal (PCS) is an older and largely no longer used measure of contrast. Contrast is intended to quantify the difference between the bars and the spaces in reflectance. PCS is defined mathematically as:

$$PCS = (R_{max} - R_{min}) / R_{max}$$

In other words, the percentage of the light background accounted for by the difference between the bars and spaces. This measure was defined as a measure of perceived contrast by the human eye, long before and outside the context of measuring barcode contrast. Notice that the measurement is made relative to the brightness of the background. The fact that it is relative to the background means that the darker (worse) the background color is, the higher (supposedly better) the value of PCS. This may correspond with the way people view things, but not really, how scanners work. Rather, scanners are sensitive to the absolute difference between the reflectance of bars and spaces. Scanners are especially sensitive to variations in contrast within the same scan.

MRD

Minimum Reflectance Difference (MRD) quantifies the minimum difference anywhere across the barcode. MRD considers the brightest (worst) bar and the darkest (worst) space anywhere in the barcode. These worst-case bar and space need not be adjacent to one another.

Cleaning/Maintenance

Cleaning the Reader Housing

To clean the outside of the reader housing, use a small amount of mild detergent cleaner or isopropyl alcohol on a cleaning cloth. Do not pour the cleaner directly onto the reader housing.

 **CAUTION:** Do not attempt to clean any DataMan product with harsh or corrosive solvents, including lye, methyl ethyl ketone (MEK) or gasoline.

Cleaning the Reader Lens Cover

To remove dust from the lens cover, use a pressurized air duster. The air must be free of oil, moisture or other contaminants that could remain on the lens cover. To clean the plastic window of the lens cover, use a small amount of isopropyl alcohol on a cleaning cloth. Do not scratch the plastic window. Do not pour the alcohol directly on the plastic window.

Regulations/Conformity

The DataMan 8072V has Regulatory Model R00071, and meets or exceeds the requirements of all applicable standards organizations for safe operation. However, as with any electrical equipment, the best way to ensure safe operation is to operate them according to the agency guidelines that follow. Please read these guidelines carefully before using your device.

Note: For the most current CE declaration and regulatory conformity information, see the Cognex support site: cognex.com/support.

Regulator	Specification
USA	FCC Part 15B, Class A
Canada	ICES-003, Class A
European Community	CE, Class A EN55032 EN55024
Japan	VCCI-3/2015.04 CISPR 22 Class A
Korea	KN32/KN35

Safety and Regulatory	
Manufacturer	Cognex Corporation One Vision Drive Natick, MA 01760 USA
	DataMan 8072V: Regulatory Model R00071 This is a class A product. In a domestic environment this product may cause radio interference in which case the user may be required to take immediate measures. This equipment complies with the essential requirements of the EU Directive 2014/30/EU. Declarations are available from your local representative.
FCC	FCC Part 15, Class A This equipment has been tested and found to comply with the limits for a Class A digital device, pursuant to part 15 of the FCC Rules. These limits are designed to provide reasonable protection against harmful interference when the equipment is operated in a commercial environment. This equipment generates, uses, and can radiate radio frequency energy and, if not installed and used in accordance with the instruction manual, may cause harmful interference to radio communications. Operation of this equipment in a residential area is likely to cause harmful interference in which case the user will be required to correct the interference at his own expense.
Canadian Compliance	This Class A digital apparatus complies with Canadian ICES-003. Cet appareil numérique de la classe A est conforme à la norme NMB-003 du Canada.

LED Safety Statement

CAUTION: Illumination and Lens assembly: This device has been tested in accordance with IEC 62471-1:2008 and has been certified to the limits of Risk Group 2. Possibly hazardous optical radiation emitted from this product. Do not stare at the operating lamp. May be harmful to the eyes.

Laser Safety Statement

WARNING: Complies with FDA performance standards for laser products except for deviations pursuant to Laser Notice No. 50, dated June 24, 2007. This device has been tested in accordance with IEC60825-1 3rd ed., and has been certified to be under the limits of a Class 2 Laser device.

Precautions

⚠ WARNING: LASER LIGHT, DO NOT STARE INTO BEAM: CLASS 2 LASER PRODUCT. FAILURE TO FOLLOW THESE INSTRUCTIONS MAY CAUSE SERIOUS INJURY.

To reduce the risk of injury or equipment damage, observe the following precautions when you install the Cognex product:

- Route cables and wires away from high-current wiring or high-voltage power sources to reduce the risk of damage or malfunction from the following causes: over-voltage, line noise, electrostatic discharge (ESD), power surges, or other irregularities in the power supply.
- Changes or modifications not expressly approved by the party responsible for regulatory compliance could void the user's authority to operate the equipment.
- Ensure that the cable bend radius begins at least six inches from the connector. Cable shielding can be degraded or cables can be damaged or wear out faster if a service loop or bend radius is tighter than 10X the cable diameter.
- This device should be used in accordance with the instructions in this manual.
- All specifications are for reference purposes only and can change without notice.

