

DataMan[®] Configuration Codes

2022 January 10
Revision: 6.1.12.1

Legal Notices

The software described in this document is furnished under license, and may be used or copied only in accordance with the terms of such license and with the inclusion of the copyright notice shown on this page. Neither the software, this document, nor any copies thereof may be provided to, or otherwise made available to, anyone other than the licensee. Title to, and ownership of, this software remains with Cognex Corporation or its licensor. Cognex Corporation assumes no responsibility for the use or reliability of its software on equipment that is not supplied by Cognex Corporation. Cognex Corporation makes no warranties, either express or implied, regarding the described software, its merchantability, non-infringement or its fitness for any particular purpose.

The information in this document is subject to change without notice and should not be construed as a commitment by Cognex Corporation. Cognex Corporation is not responsible for any errors that may be present in either this document or the associated software.

Companies, names, and data used in examples herein are fictitious unless otherwise noted. No part of this document may be reproduced or transmitted in any form or by any means, electronic or mechanical, for any purpose, nor transferred to any other media or language without the written permission of Cognex Corporation.

Copyright © 2021. Cognex Corporation. All Rights Reserved.

Portions of the hardware and software provided by Cognex may be covered by one or more U.S. and foreign patents, as well as pending U.S. and foreign patents listed on the Cognex web site at: cognex.com/patents.

The following are registered trademarks of Cognex Corporation:

Cognex, 2DMAX, Advantage, AlignPlus, Assemblyplus, Check it with Checker, Checker, Cognex Vision for Industry, Cognex VSOC, CVL, DataMan, DisplayInspect, DVT, EasyBuilder, Hotbars, IDMax, In-Sight, Laser Killer, MVS-8000, OmniView, PatFind, PatFlex, PatInspect, PatMax, PatQuick, SensorView, SmartView, SmartAdvisor, SmartLearn, UltraLight, Vision Solutions, VisionPro, VisionView

The following are trademarks of Cognex Corporation:

The Cognex logo, 1DMax, 3D-Locate, 3DMax, BGAll, CheckPoint, Cognex VSoC, CVC-1000, FFD, iLearn, In-Sight (design insignia with cross-hairs), In-Sight 2000, InspectEdge, Inspection Designer, MVS, NotchMax, OCRMax, PatMax RedLine, ProofRead, SmartSync, ProfilePlus, SmartDisplay, SmartSystem, SMD4, VisiFlex, Xpand

Portions copyright © Microsoft Corporation. All rights reserved.

Portions copyright © MadCap Software, Inc. All rights reserved.

Other product and company trademarks identified herein are the trademarks of their respective owners.

Table of Contents

Legal Notices	2
Table of Contents	3
Configuration Codes	5
Product Settings	6
Reset	7
Disable Buttons	8
Diagnostics	9
Setup	10
Light Aimer	11
Trigger Type	12
Custom Commands	14
Maximum Exposure	15
Symbology Settings	18
2D Symbology Settings	28
QR Code Maximum Grid Size	30
1D Symbology Settings	32
Training	34
Data Validation / Data Formatting	35
Non-Printable Characters	37
Wireless	38
Buffering	40
Power Management	41
Wake-up Message	43
PS/2 Keyboard Emulation Enable	44
ASCII Keyboard Command Codes	45
iOS Keyboard Configuration	57
USB Connection	58
USB Mode	62
Communications	64
RS-232 Baud Rate	68
RS-232 Parity Settings	70
RS-232 Databit Settings	72
RS-232 Stopbit Settings	73

RS-232 Handshaking	74
RS-232 Routing	75
Network Settings	76
Decode Settings	77
Multi-Reader Sync	78
Keyboard Layout	79
Alt Key Combo Zero Padding	85
USB Keyboard Inter-Character Delay	86
WebHMI Commands	87

Configuration Codes

This manual provides a list of Configuration Codes which are special Data Matrix codes to configure your reader without the DataMan Setup Tool. Lights and 1 beep indicate that a Configuration Code was read. If the code is read but the command is not executed (e.g. because of the command not being valid for the type of reader used for reading the code), the reader gives 2 beeps.

You can read configuration codes without enabling the decoding of Data Matrix symbols. Make sure that you use Manual or Presentation trigger mode.



Adjust focus settings if you have trouble reading Configuration Codes.

Note: When applying polarized filter on the reader, it is recommended to read the codes from a printed material. It is possible that the reader with a polarized filter cannot read the code correctly from a screen.



Note: When using wireless handheld readers, the reader must be put on the base station for security reasons after reading a printed configuration code.

Note: The asterisk indicates the default value for all the consecutive or the indicated reader(s).

Product Settings

Codes	Settings and Supported Devices	Codes
	<p>Reboot Scanner</p> <p>DM50 • DM60 • DM70 • DM150 • DM260 • DM300 • DM360 • DM370 • DM470 • DM475V • DM503 • DM8000 • MX-1000 • MX-1502</p>	
	<p>Reboot Base Station</p> <p>DM8000Base (IBASE) • DM8700Base</p>	
	<p>Save Settings to Reader</p> <p>DM50 • DM60 • DM70 • DM150 • DM260 • DM300 • DM360 • DM370 • DM470 • DM503 • DM8000 • MX-1000 • MX-1502</p>	

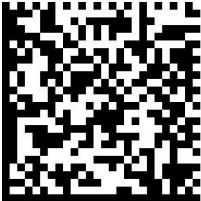

Reset

Codes	Settings and Supported Devices	Codes
	<p>Reset Scanner to Factory Defaults</p> <p>DM50 • DM60 • DM70 • DM150 • DM260 • DM300 • DM360 • DM370 • DM470 • DM475V • DM503 • DM8000 • DM8700 • MX-1000 • MX-1502</p>	
	<p>Reset Base Station to Factory Defaults</p> <p>DM8000Base (IBASE) • DM8700Base</p>	

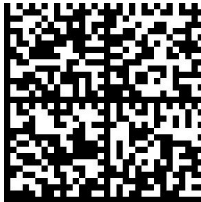

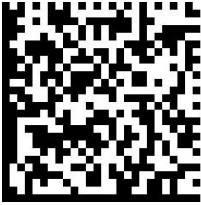

Disable Buttons

Codes	Settings and Supported Devices	Codes
	<p>Disable Trigger Button</p> <p>DM50 • DM60 • DM70 • DM150 • DM260 • DM300 • DM360 • DM370 • DM470 • DM503</p>	
	<p>Disable Tune Button</p> <p>DM50 • DM60 • DM70 • DM150 • DM260 • DM300 • DM360 • DM370 • DM470 • DM503</p>	



Diagnostics

Codes	Settings and Supported Devices	Codes
	<p>Output Diagnostic String (only with RS-232 and USB connections)</p> <p>DM50 • DM60 • DM70 • DM150 • DM260 • DM300 • DM360 • DM370 • DM470 • DM503 • DM8000 • MX- 1000 • MX-1502</p>	
	<p>Output Diagnostic String (through the DM8000 Base Station with RS-232 and USB connections)</p> <p>DM8000 wireless • DM8700 Base</p>	



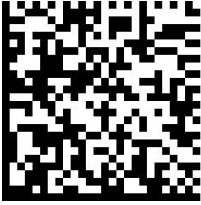

Setup

Codes	Settings and Supported Devices	Codes
	<p>Enable Setup 1 Only</p> <ul style="list-style-type: none"> • DM8600 • DM8072 • DM8700 	
	<p>Enable Setup 2 Only</p> <ul style="list-style-type: none"> • DM8600 • DM8072 • DM8700 	
	<p>Enable Setup 3 Only</p> <ul style="list-style-type: none"> • DM8600 • DM8072 • DM8700 	
	<p>Enable Setup 4 Only</p> <ul style="list-style-type: none"> • DM8600 • DM8072 	

Light Aimer



Codes	Settings and Supported Devices	Codes
	<p>*Light aimer ON (default for DM50, DM60, and DM8000)</p> <p>DM50 • DM60 • DM70 • DM150 • DM260 • DM300 • DM360 • DM370 • DM470 • DM8000 • MX-1000 • MX- 1502</p>	
	<p>Laser Aimer Movement</p> <p>• DM8072</p>	
	<p>*Light aimer OFF (default for DM300)</p> <p>DM50 • DM60 • DM70 • M150 • DM260 • DM300 • DM360 • DM370 • DM470 • DM8000 • MX-1000 • MX- 1502</p>	

Trigger Type

Codes	Settings and Supported Devices	Codes
	<p>Enable Presentation</p> <p>DM50 • DM60 • DM70 • DM150 • DM260 • DM300 • DM360 • DM370 • DM470 • DM503 • DM8000 • MX-1000</p>	
	<p>*Enable Manual (button)</p> <p>DM50 • DM60 • DM70 • DM150 • DM260 • DM300 • DM360 • DM370 • DM470 • DM503 • DM8000 • MX-1000 • MX-1502</p>	
	<p>Enable Single (external)</p> <p>DM50 • DM60 • DM70 • DM150 • DM260 • DM300 • DM360 • DM370 • DM470 • DM503</p>	
	<p>Enable Burst (external)</p> <p>DM50 • DM60 • DM70 • DM150 • DM260 • DM300 • DM360 • DM370 • DM470 • DM503</p>	
	<p>Enable Self (internal)</p> <p>DM50 • DM60 • DM70 • DM150 • DM260 • DM300 • DM360 • DM370 • DM470 • DM503</p>	



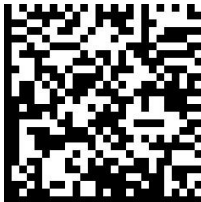

Codes	Settings and Supported Devices	Codes
	<p data-bbox="606 216 931 247">Enable Continuous (external)</p> <p data-bbox="474 359 1064 422">DM50 • DM60 • DM70 • DM150 • DM260 • DM300 • DM360 • DM370 • DM470 • DM503</p>	

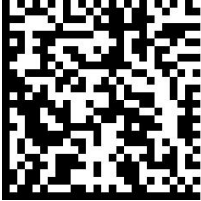

Custom Commands

Codes	Settings and Supported Devices	Codes
	<p>Enable Serial Trigger</p> <p>DM50 • DM60 • DM70 • DM150 • DM260 • DM300 • DM360 • DM370 • DM470 • DM503</p>	
	<p>*Disable Serial Trigger</p> <p>DM50 • DM60 • DM70 • DM150 • DM260 • DM300 • DM360 • DM370 • DM470 • DM503</p>	
	<p>Enable Echo Commands</p> <p>DM50 • DM60 • DM70 • DM150 • DM260 • DM300 • DM360 • DM370 • DM470 • DM503</p>	
	<p>*Disable Echo Commands</p> <p>DM50 • DM60 • DM70 • DM150 • DM260 • DM300 • DM360 • DM370 • DM470 • DM503</p>	

Maximum Exposure



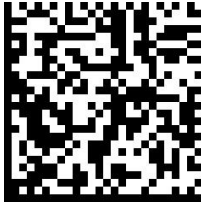

Note: Attempts to set exposure above the highest possible exposure value of the device results in exposure changed to the device maximum.

Codes	Settings and Supported Devices	Codes
	<p>100 μs</p> <p>DM50 • DM60 • DM70 • DM150 • DM260 • DM300 • DM360 • DM370 • DM470 • DM503 • DM8000 • MX-1000 • MX-1502</p>	
	<p>133 μs</p> <p>DM50 • DM60 • DM70 • DM150 • DM260 • DM300 • DM360 • DM370 • DM470 • DM503 • DM8000 • MX-1000 • MX-1502</p>	
	<p>*170 μs</p> <p>DM50 • DM60 • DM70 • DM150 • DM260 • DM300 • DM360 • DM370 • DM470 • DM503 • DM8000 • MX-1000 • MX-1502</p>	
	<p>250 μs</p> <p>DM50 • DM60 • DM70 • DM150 • DM260 • DM300 • DM360 • DM370 • DM470 • DM503 • DM8000 • MX-1000 • MX-1502</p>	





Codes	Settings and Supported Devices	Codes
	<p>500 μs</p> <p>DM50 • DM60 • DM70 • DM150 • DM260 • DM300 • DM360 • DM370 • DM470 • DM503 • DM8000 • MX-1000 • MX-1502</p>	
	<p>800 μs</p> <p>DM50 • DM60 • DM70 • DM150 • DM260 • DM300 • DM360 • DM370 • DM470 • DM503 • DM8000 • MX-1000 • MX-1502</p>	
	<p>*1000 μs (default for DM50, DM60, DM70, DM300, DM360, DM470, and DM503)</p> <p>DM50 • DM60 • DM70 • DM150 • DM260 • DM300 • DM360 • DM370 • DM470 • DM503 • DM8000 • MX-1000 • MX-1502</p>	
	<p>2000 μs</p> <p>DM50 • DM60 • DM70 • DM150 • DM260 • DM360 • DM370 • DM470 • DM503 • DM8000 • MX-1000 • MX-1502</p>	
	<p>*5000 μs (default for MX-1000 and MX-1502)</p> <p>DM50 • DM60 • DM70 • DM150 • DM260 • DM503 • DM8000 • MX-1000 • MX-1502</p>	

Codes	Settings and Supported Devices	Codes
	<p>8000 μs</p> <p>DM50 • DM60 • DM70 • DM150 • DM260 • DM503 • DM8000 • MX-1000 • MX-1502</p>	
	<p>10000 μs</p> <p>DM50 • DM60 • DM70 • DM150 • DM260 • DM503 • DM8000 • MX-1000 • MX-1502</p>	
	<p>*13333 μs (default for DM8000)</p> <p>DM50 • DM60 • DM70 • DM150 • DM260 • DM503 • DM8000 • MX-1000 • MX-1502</p>	
	<p>20000 μs</p> <p>DM50 • DM60 • DM70 • DM150 • DM260 • DM503 • DM8000 • MX-1000 • MX-1502</p>	
	<p>25000 μs</p> <p>DM50 • DM60 • DM70 • DM150 • DM260 • DM503 • DM8000 • MX-1000 • MX-1502</p>	

Symbology Settings

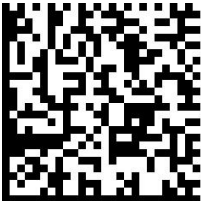
Codes	Settings and Supported Devices	Codes
	<p>*Enable ID Max</p> <p>DM50 • DM60 • DM70 • DM150 • DM260 • DM300 • DM360 • DM370 • DM470 • DM503 • DM8700</p>	
	<p>Enable ID Quick</p> <p>DM50 • DM60 • DM70 • DM150 • DM260 • DM300 • DM360 • DM370 • DM470 • DM503 • DM8700</p>	
	<p>*Enable Data Matrix</p> <p>DM50 • DM60 • DM70 • DM150 • DM260 • DM300 • DM360 • DM370 • DM470 • DM503 • DM8000 • MX- 1000 • MX-1502</p>	
	<p>Disable Data Matrix</p> <p>DM50 • DM60 • DM70 • DM150 • DM260 • DM300 • DM360 • DM370 • DM470 • DM503 • DM8000 • MX- 1000 • MX-1502</p>	
	<p>Enable QR Code</p> <p>DM50 • DM60 • DM70 • DM150 • DM260 • DM300 • DM360 • DM370 • DM470 • DM503 • DM8000 • MX- 1000 • MX-1502</p>	

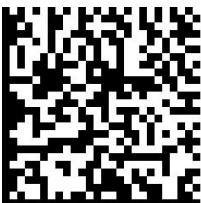

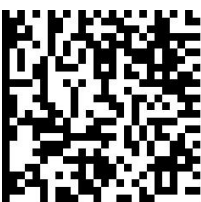

Codes	Settings and Supported Devices	Codes
	<p style="text-align: center;">*Disable QR Code</p> <p>DM50 • DM60 • DM70 • DM150 • DM260 • DM300 • DM360 • DM370 • DM470 • DM503 • DM8000 • MX-1000 • MX-1502</p>	
	<p style="text-align: center;">Enable MaxiCode</p> <p>DM50 • DM60 • DM70 • DM150 • DM260 • DM300 • DM360 • DM370 • DM470 • DM503 • DM8050 • DM8600 • DM8072 • DM8700</p>	
	<p style="text-align: center;">*Disable MaxiCode</p> <p>DM50 • DM60 • DM70 • DM150 • DM260 • DM300 • DM360 • DM370 • DM470 • DM503 • DM8050 • DM8600 • DM8072 • DM8700</p>	
	<p style="text-align: center;">Enable Aztec Code</p> <p>DM150 • DM260 • DM300 • DM360 • DM370 • DM470 • DM503 • DM8050 • DM8600 • DM8072 • DM8700</p>	
	<p style="text-align: center;">*Disable Aztec Code</p> <p>DM150 • DM260 • DM300 • DM360 • DM370 • DM470 • DM503 • DM8050 • DM8600 • DM8072 • DM8700</p>	



Codes	Settings and Supported Devices	Codes
	<p>*Enable Code 128</p> <p>DM50 • DM60 • DM70 • DM150 • DM260 • DM300 • DM360 • DM370 • DM470 • DM503 • DM8000 • MX-1000 • MX-1502</p>	
	<p>Disable Code 128</p> <p>DM50 • DM60 • DM70 • DM150 • DM260 • DM300 • DM360 • DM370 • DM470 • DM503 • DM8000 • MX-1000 • MX-1502</p>	
	<p>*Enable UPC/EAN</p> <p>DM50 • DM60 • DM70 • DM150 • DM260 • DM300 • DM360 • DM370 • DM470 • DM503 • DM8000 • MX-1000 • MX-1502</p>	
	<p>Disable UPC/EAN</p> <p>DM50 • DM60 • DM70 • DM150 • DM260 • DM300 • DM360 • DM370 • DM470 • DM503 • DM8000 • MX-1000 • MX-1502</p>	
	<p>*Enable Code 39</p> <p>DM50 • DM60 • DM70 • DM150 • DM260 • DM300 • DM360 • DM370 • DM470 • DM503 • DM8000 • MX-1000 • MX-1502</p>	

Codes	Settings and Supported Devices	Codes
	<p>Disable Code 39</p> <p>DM50 • DM60 • DM70 • DM150 • DM260 • DM300 • DM360 • DM370 • DM470 • DM503 • DM8000 • MX-1000 • MX-1502</p>	
	<p>*Enable Code 93</p> <p>DM50 • DM60 • DM70 • DM150 • DM260 • DM300 • DM360 • DM370 • DM470 • DM503 • DM8000 • MX-1000 • MX-1502 • DM8072</p>	
	<p>Disable Code 93</p> <p>DM50 • DM60 • DM70 • DM150 • DM260 • DM300 • DM360 • DM370 • DM470 • DM503 • DM8000 • MX-1000 • MX-1502</p>	
	<p>Enable Interleaved 2 of 5</p> <p>DM50 • DM60 • DM70 • DM150 • DM260 • DM300 • DM360 • DM370 • DM470 • DM503 • DM8000</p>	
	<p>*Disable Interleaved 2 of 5</p> <p>DM50 • DM60 • DM70 • DM150 • DM260 • DM300 • DM360 • DM370 • DM470 • DM503 • DM8000 • MX-1000 • MX-1502</p>	

Codes	Settings and Supported Devices	Codes
	<p>*Enable Codabar</p> <p>DM50 • DM60 • DM70 • DM150 • DM260 • DM300 • DM360 • DM370 • DM470 • DM503 • DM8000 • MX-1000 • MX-1502</p>	
	<p>Disable Codabar</p> <p>DM50 • DM60 • DM70 • DM150 • DM260 • DM300 • DM360 • DM370 • DM470 • DM503 • DM8000 • MX-1000 • MX-1502</p>	
	<p>Enable Pharmacode (Not supported on DM8700)</p> <p>DM50 • DM60 • DM70 • DM150 • DM260 • DM300 • DM360 • DM370 • DM470 • DM503 • DM8000 • MX-1000 • MX-1502</p>	
	<p>*Disable Pharmacode</p> <p>DM50 • DM60 • DM70 • DM150 • DM260 • DM300 • DM360 • DM370 • DM470 • DM503 • DM8000 • MX-1000 • MX-1502</p>	
	<p>*Enable PDF417 (default for handheld readers)</p> <p>DM50 • DM60 • DM70 • DM150 • DM260 • DM300 • DM360 • DM370 • DM470 • DM503 • DM8000 • MX-1000 • MX-1502</p>	

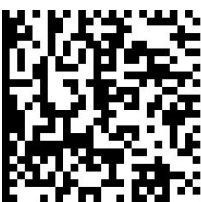
Codes	Settings and Supported Devices	Codes
	<p>*Disable PDF417 (default for fixed-mount readers)</p> <p>DM50 • DM60 • DM70 • DM150 • DM260 • DM300 • DM360 • DM370 • DM470 • DM503 • DM8000 • MX-1000 • MX-1502</p>	
	<p>Enable Databar (Not supported on DM8700)</p> <p>DM50 • DM60 • DM70 • DM150 • DM260 • DM300 • DM360 • DM370 • DM470 • DM503 • DM8000 • MX-1000 • MX-1502</p>	
	<p>*Disable Databar</p> <p>DM50 • DM60 • DM70 • DM150 • DM260 • DM300 • DM360 • DM370 • DM470 • DM503 • DM8000 • MX-1000 • MX-1502</p>	
	<p>Enable Micro PDF417 (Not supported on DM8700)</p> <p>DM50 • DM60 • DM70 • DM150 • DM260 • DM300 • DM360 • DM370 • DM470 • DM503 • DM8000 • MX-1000 • MX-1502</p>	
	<p>*Disable Micro PDF417</p> <p>DM50 • DM60 • DM70 • DM150 • DM260 • DM300 • DM360 • DM370 • DM470 • DM503 • DM8000 • MX-1000 • MX-1502</p>	

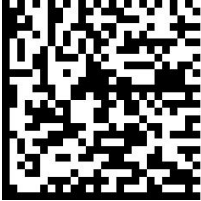
Codes	Settings and Supported Devices	Codes
	<p>Enable EAN.UCC Composite (Not supported on DM8700)</p> <p>DM50 • DM60 • DM70 • DM150 • DM260 • DM300 • DM360 • DM370 • DM470 • DM503 • DM8000 • MX- 1000 • MX-1502</p>	
	<p>*Disable EAN.UCC Composite</p> <p>DM50 • DM60 • DM70 • DM150 • DM260 • DM300 • DM360 • DM370 • DM470 • DM503 • DM8000 • MX- 1000 • MX-1502</p>	
	<p>Enable POSTNET</p> <p>DM50 • DM60 • DM70 • DM150 • DM260 • DM300 • DM360 • DM370 • DM470 • DM503 • DM8000 • MX- 1000 • MX-1502</p>	
	<p>*Disable POSTNET</p> <p>DM50 • DM60 • DM70 • DM150 • DM260 • DM300 • DM360 • DM370 • DM470 • DM503 • DM8000 • MX- 1000 • MX-1502</p>	
	<p>Enable PLANET</p> <p>DM50 • DM60 • DM70 • DM150 • DM260 • DM300 • DM360 • DM370 • DM470 • DM503 • DM8000 • MX- 1000 • MX-1502</p>	

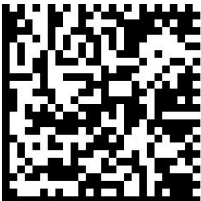
Codes	Settings and Supported Devices	Codes
	<p>*Disable PLANET</p> <p>DM50 • DM60 • DM70 • DM150 • DM260 • DM300 • DM360 • DM370 • DM470 • DM503 • DM8000 • MX-1000 • MX-1502</p>	
	<p>Enable Japan Post</p> <p>DM50 • DM60 • DM70 • DM150 • DM260 • DM300 • DM360 • DM370 • DM470 • DM503 • DM8000 • MX-1000 • MX-1502</p>	
	<p>*Disable Japan Post</p> <p>DM50 • DM60 • DM70 • DM150 • DM260 • DM300 • DM360 • DM370 • DM470 • DM503 • DM8000 • MX-1000 • MX-1502</p>	
	<p>Enable Australia Post</p> <p>DM50 • DM60 • DM70 • DM150 • DM260 • DM300 • DM360 • DM370 • DM470 • DM503 • DM8000 • MX-1000 • MX-1502</p>	
	<p>*Disable Australia Post</p> <p>DM50 • DM60 • DM70 • DM150 • DM260 • DM300 • DM360 • DM370 • DM470 • DM503 • DM8000 • MX-1000 • MX-1502</p>	

Codes	Settings and Supported Devices	Codes
	<p>Enable UPU</p> <p>DM50 • DM60 • DM70 • DM150 • DM260 • DM300 • DM360 • DM370 • DM470 • DM503 • DM8000 • MX-1000 • MX-1502</p>	
	<p>*Disable UPU</p> <p>DM50 • DM60 • DM70 • DM150 • DM260 • DM300 • DM360 • DM370 • DM470 • DM503 • DM8000 • MX-1000 • MX-1502</p>	
	<p>Enable Intelligent Mail Barcode</p> <p>DM50 • DM60 • DM70 • DM150 • DM260 • DM300 • DM360 • DM370 • DM470 • DM503 • DM8000 • MX-1000 • MX-1502</p>	
	<p>*Disable Intelligent Mail Barcode</p> <p>DM50 • DM60 • DM70 • DM150 • DM260 • DM300 • DM360 • DM370 • DM470 • DM503 • DM8000 • MX-1000 • MX-1502</p>	
	<p>Enable Customer Bar Code (CBC) Symbology</p> <p>DM50 • DM60 • DM70 • DM150 • DM260 • DM30x • DM360 • DM370 • DM470 • DM503 • MX-1000 • MX-1502</p>	



Codes	Settings and Supported Devices	Codes
	<p data-bbox="512 216 1025 247">Disable Customer Bar Code (CBC) Symbology</p> <p data-bbox="471 359 1067 453">DM50 • DM60 • DM70 • DM150 • DM260 • DM30x • DM360 • DM370 • DM470 • DM503 • MX-1000 • MX- 1502</p>	 A square QR code located in the rightmost column of the table, used for linking to the settings.

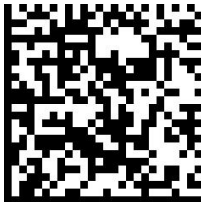
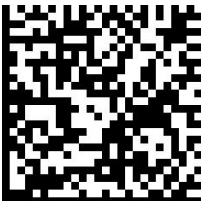
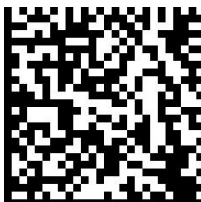
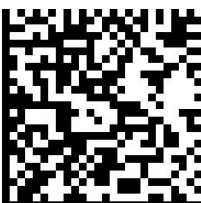

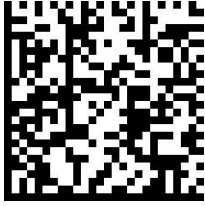
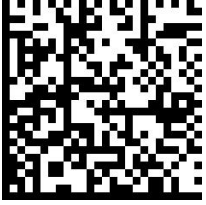
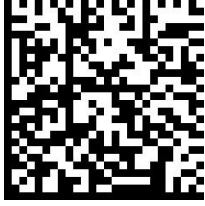
2D Symbology Settings

Codes	Settings and Supported Devices	Codes
	<p>Enable Extreme Print Growth (Data Matrix only)</p> <p>MX-1000 • MX-1502</p>	
	<p>*Disable Extreme Print Growth (Data Matrix only)</p> <p>MX-1000 • MX-1502</p>	
	<p>DataMatrix Symbol Difficulty - Easy</p> <p>DM8600 • DM8700</p>	
	<p>*DataMatrix Symbol Difficulty - Medium</p> <p>DM8600 • DM8700</p>	
	<p>DataMatrix Symbol Difficulty - Hard</p> <p>DM8600 • DM8700</p>	

Codes	Settings and Supported Devices	Codes
	<p data-bbox="612 216 920 247">*QR Symbol Difficulty - Easy</p> <p data-bbox="659 359 874 390">DM8600 • DM8700</p>	
	<p data-bbox="602 525 936 556">QR Symbol Difficulty - Medium</p> <p data-bbox="659 667 874 699">DM8600 • DM8700</p>	
	<p data-bbox="617 833 920 865">QR Symbol Difficulty - Hard</p> <p data-bbox="659 976 874 1008">DM8600 • DM8700</p>	

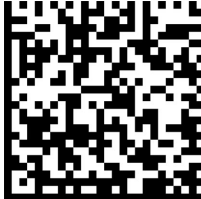

QR Code Maximum Grid Size

Codes	Settings and Supported Devices	Codes
	<p>*Version 8 (49x49)</p> <p>DM50 • DM60 • DM70 • DM150 • DM260 • DM300 • DM360 • DM370 • DM470 • DM503 • MX-1000 • MX-1502 • DM8600 • DM8050 • DM8700</p>	
	<p>Version 9 (53x53)</p> <p>DM50 • DM60 • DM70 • DM150 • DM260 • DM300 • DM360 • DM370 • DM470 • DM503 • MX-1000 • MX-1502 • DM8600 • DM8050 • DM8700</p>	
	<p>Version 10 (57x57)</p> <p>DM50 • DM60 • DM150 • DM260 • DM300 • DM360 • DM370 • DM470 • DM503 • MX-1000 • MX-1502 • DM8600 • DM8050 • DM8700</p>	
	<p>Version 12 (65x65)</p> <p>DM50 • DM60 • DM70 • DM150 • DM260 • DM300 • DM360 • DM370 • DM470 • DM503 • MX-1000 • MX-1502 • DM8600 • DM8050 • DM8072 • DM8700</p>	





Codes	Settings and Supported Devices	Codes
	<p>Version 16 (81x81)</p> <p>DM50 • DM60 • DM70 • DM150 • DM260 • DM300 • DM360 • DM370 • DM470 • DM503 • MX-1000 • MX-1502 • DM8600 • DM8050 • DM8072 • DM8700</p>	
	<p>Version 20 (97x97)</p> <p>DM50 • DM60 • DM70 • DM150 • DM260 • DM300 • DM360 • DM370 • DM470 • DM503 • MX-1000 • MX-1502 • DM8600 • DM8050 • DM8072 • DM8700</p>	
	<p>Version 40 (177x177)</p> <p>DM50 • DM60 • DM70 • DM150 • DM260 • DM300 • DM360 • DM370 • DM470 • DM503 • MX-1000 • MX-1502 • DM8600 • DM8050 • DM8072 • DM8700</p>	

1D Symbology Settings



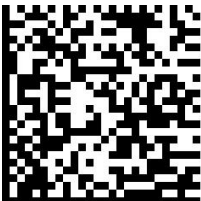

Codes	Settings and Supported Devices	Codes
	<p>*Enable Use Target Decoding (simulates laser scanning) (default for handheld readers except for DM8700)</p> <p>DM8000 • MX-1000 • MX-1502</p>	
	<p>*Disable Use Target Decoding (simulates laser scanning) (default for fixed mount readers, DM8000 and MX-1000 • MX-1502)</p> <p>DM8000 • MX-1000 • MX-1502</p>	
	<p>*Enable Short Quiet Zone</p> <p>DM50 • DM60 • DM70 • DM150 • DM260 • DM300 • DM360 • DM370 • DM470 • DM503 • DM8000 • MX-1000 • MX-1502</p>	
	<p>Disable Short Quiet Zone</p> <p>DM50 • DM60 • DM70 • DM150 • DM260 • DM300 • DM360 • DM370 • DM470 • DM503 • DM8000 • MX-1000 • MX-1502</p>	
	<p>Code Orientation: Omnidirectional</p> <p>DM50 • DM60 • DM70 • DM150 • DM260 • DM300 • DM360 • DM370 • DM470 • DM503</p>	

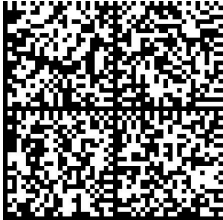

Codes	Settings and Supported Devices	Codes
	<p>Code Orientation: Ladder and Picket Fence</p> <p>DM50 • DM60 • DM70 • DM150 • DM260 • DM300 • DM360 • DM370 • DM470 • DM503</p>	
	<p>Code Orientation: Ladder</p> <p>DM50 • DM60 • DM70 • DM150 • DM260 • DM300 • DM360 • DM370 • DM470 • DM503</p>	
	<p>Code Orientation: Picket Fence (for readers which support oriented 1-D reading)</p> <p>DM50 • DM60 • DM70 • DM150 • DM260 • DM300 • DM360 • DM370 • DM470 • DM503</p>	

Training



Codes	Settings and Supported Devices	Codes
	<p>Enable incremental training</p> <p>DM50 • DM60 • DM70 • DM150 • DM260 • DM300 • DM360 • DM370 • DM470 • DM503</p>	
	<p>*Disable incremental training</p> <p>DM50 • DM60 • DM70 • DM150 • DM260 • DM300 • DM360 • DM370 • DM470 • DM503</p>	
	<p>Enable untrained symbologies</p> <p>DM50 • DM60 • DM70 • DM150 • DM260 • DM300 • DM360 • DM370 • DM470 • DM503</p>	
	<p>*Disable untrained symbologies</p> <p>DM50 • DM60 • DM70 • DM150 • DM260 • DM300 • DM360 • DM370 • DM470 • DM503</p>	

Data Validation / Data Formatting



Codes	Settings and Supported Devices	Codes
	<p>Enable DoD UID Validation with UII Output</p> <p>DM50 • DM60 • DM70 • DM150 • DM260 • DM300 • DM360 • DM370 • DM470 • DM503 • DM8000 • MX-1000 • MX-1502</p>	
	<p>*Disable DoD UID Validation with UII Output</p> <p>DM50 • DM60 • DM70 • DM150 • DM260 • DM300 • DM360 • DM370 • DM470 • DM503 • DM8000 • MX-1000 • MX-1502</p>	
	<p>Use Next Code As Match String (Enable Match String Validation prior to reading this code)</p> <p>DM50 • DM60 • DM70 • DM150 • DM260 • DM300 • DM360 • DM370 • DM470 • DM503 • DM8000 • MX-1000 • MX-1502</p>	
	<p>Enable Input 1 Save Match String</p> <p>DM50 • DM60 • DM70 • DM150 • DM260 • DM300 • DM360 • DM370 • DM470 • DM503</p>	

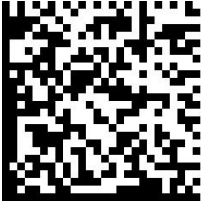

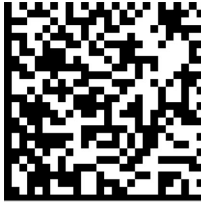
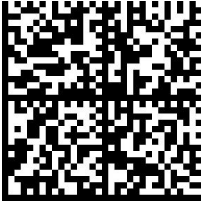

Codes	Settings and Supported Devices	Codes
	<p>*Disable Input 1 Save Match String</p> <p>DM50 • DM60 • DM70 • DM150 • DM260 • DM300 • DM360 • DM370 • DM470 • DM503</p>	
	<p>Enable Button Save Match String</p> <p>DM150 • DM260 • DM300 • DM360 • DM370 • DM470 • DM503</p>	
	<p>*Disable Button Save Match String</p> <p>DM150 • DM260 • DM300 • DM360 • DM370 • DM470 • DM503</p>	

Non-Printable Characters

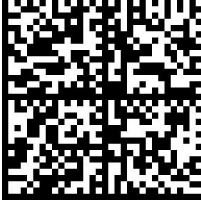



Codes	Settings and Supported Devices	Codes
	<p>Enable Translate Unprintable Characters</p> <p>DM50 • DM60 • DM70 • DM150 • DM260 • DM300 • DM360 • DM370 • DM470 • DM503 • DM8000 • MX-1000 • MX-1502</p>	
	<p>*Disable Translate Unprintable Characters</p> <p>DM50 • DM60 • DM70 • DM150 • DM260 • DM300 • DM360 • DM370 • DM470 • DM503 • DM8000 • MX-1000 • MX-1502</p>	

Wireless

Codes	Settings and Supported Devices	Codes
	<p>Unassign Reader from Base Station (Not required for DM8700)</p> <p>DM8000 Wireless</p>	
	<p>Force Pairing Mode</p> <p>DM8050 • DM8600</p>	
	<p>Bluetooth Radio Power Low</p> <p>DM8000Base (IBASE BT)</p>	
	<p>Bluetooth Radio Power Medium</p> <p>DM8000Base (IBASE BT)</p>	
	<p>Bluetooth Radio Power High</p> <p>DM8000Base (IBASE BT)</p>	

Codes	Settings and Supported Devices	Codes
	<p data-bbox="478 216 1056 239">Set the default DMCC communication to Base Station</p> <p data-bbox="691 289 843 312">DM8700Base</p> <hr/> <p data-bbox="498 384 563 407">Note:</p> <p data-bbox="463 422 1056 501">  After a factory reset or loading a custom configuration to the Base Station the Default Target is reset to the Base Station. </p>	
	<p data-bbox="505 537 1033 560">Set the default DMCC communication to Reader</p> <p data-bbox="691 611 843 634">DM8700Base</p> <hr/> <p data-bbox="498 663 563 686">Note:</p> <p data-bbox="463 701 1025 781">  After a factory reset or loading a custom configuration to the Reader the Default Target is reset to the Base Station. </p>	

Buffering



Codes	Settings and Supported Devices	Codes
	<p>*Enable Offline Buffering (Not required for DM8700)</p> <p>DM8000 Wireless • MX-1000</p>	
	<p>Disable Offline Buffering (Not required for DM8700)</p> <p>DM8000 Wireless • MX-1000</p>	
	<p>*Offline Buffering Mode - Multiple (Not required for DM8700)</p> <p>DM8000 Wireless</p>	
	<p>Offline Buffering Mode - Single (Not required for DM8700)</p> <p>DM8000 Wireless</p>	

Power Management

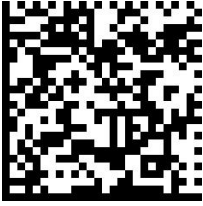
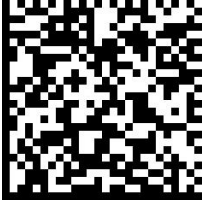
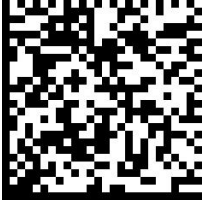
Codes	Settings and Supported Devices	Codes
	<p>Disable Hibernation Mode (Not supported on DM8700)</p> <p>DM8000 Wireless • MX-1000</p>	
	<p>*Enable Hibernation Mode (Not supported on DM8700)</p> <p>DM8000 Wireless • MX-1000</p>	
	<p>Disable Power Off Mode</p> <p>DM8000 Wireless • MX-1000 • MX-1502</p>	
	<p>Enable Power Off Mode</p> <p>DM8000 Wireless • MX-1000 • MX-1502</p>	
	<p>Power Off Timeout (1 minute)</p> <p>DM8000 Wireless • MX-1000 • MX-1502</p>	

Codes	Settings and Supported Devices	Codes
	<p data-bbox="602 216 936 243">Power Off Timeout (3 minutes)</p> <p data-bbox="543 359 994 386">DM8000 Wireless • MX-1000 • MX-1502</p>	
	<p data-bbox="594 525 944 552">Power Off Timeout (15 minutes)</p> <p data-bbox="543 667 994 695">DM8000 Wireless • MX-1000 • MX-1502</p>	
	<p data-bbox="594 833 944 861">Power Off Timeout (30 minutes)</p> <p data-bbox="543 976 994 1003">DM8000 Wireless • MX-1000 • MX-1502</p>	

Wake-up Message

Codes	Settings and Supported Devices	Codes
	<p>Enable Output Diagnostic String on Wake-up</p> <p>DM50 • DM60 • DM70 • DM150 • DM260 • DM300 • DM360 • DM370 • DM470 • DM503 • DM8000 • MX-1000 • MX-1502</p>	
	<p>*Disable Output Diagnostic String on Wake-up</p> <p>DM50 • DM60 • DM70 • DM150 • DM260 • DM300 • DM360 • DM370 • DM470 • DM503 • DM8000 • MX-1000 • MX-1502</p>	











PS/2 Keyboard Emulation Enable











Codes	Settings and Supported Devices	Codes
	<p>PS/2 Keyboard Emulation Enable (Not supported on DM8700)</p> <p>DM50 • DM70 • DM8000</p> <p>DO NOT SCAN this code when you have an actual keyboard connected.</p>	
	<p>*PS/2 Keyboard Emulation Disable (Not supported on DM8700)</p> <p>DM50 • DM70 • DM8000</p>	
	<p>Base Station PS/2 Keyboard Emulation Enable (Not supported on DM8700)</p> <p>DM8000Base (IBASE)</p> <p>DO NOT SCAN this code when you have an actual keyboard connected.</p>	
	<p>Base Station PS/2 Keyboard Emulation Disable (Not supported on DM8700)</p> <p>DM8000Base (IBASE)</p>	





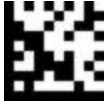

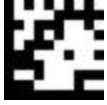





ASCII Keyboard Command Codes









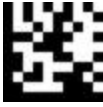

1. Set the data formatting on the DataMan to "Full String".
2. Put the reader into keyboard mode and scan the code. The DataMan will execute this command.











Codes	Settings and Supported Devices	Codes
	<p>ENTER main ENTER, not numeric keypad ENTER</p> <p>DM50 • DM60 • DM70 • DM8000 • DM8000Base (IBASE) • DM8700Base</p>	
	<p>ESCAPE</p> <p>DM50 • DM60 • DM70 • DM8000 • DM8000Base (IBASE) • DM8700Base</p>	
	<p>BACKSPACE</p> <p>DM50 • DM60 • DM8000 • DM8000Base (IBASE) • DM8700Base</p>	
	<p>TAB</p> <p>DM50 • DM60 • DM70 • DM8000 • DM8000Base (IBASE) • DM8700Base</p>	
	<p>ALT+A specifically the left ALT key</p> <p>DM50 • DM60 • DM70 • DM8000 • DM8000Base (IBASE) • DM8700Base</p>	
	<p>ALT+B specifically the left ALT key</p> <p>DM50 • DM60 • DM70 • DM8000 • DM8000Base (IBASE) • DM8700Base</p>	
	<p>ALT+C specifically the left ALT key</p> <p>DM50 • DM60 • DM70 • DM8000 • DM8000Base (IBASE) • DM8700Base</p>	
	<p>ALT+D specifically the left ALT key</p> <p>DM50 • DM60 • DM70 • DM8000 • DM8000Base (IBASE) • DM8700Base</p>	
	<p>ALT+E specifically the left ALT key</p> <p>DM50 • DM60 • DM70 • DM8000 • DM8000Base (IBASE) • DM8700Base</p>	
	<p>ALT+F specifically the left ALT key</p> <p>DM50 • DM60 • DM70 • DM8000 • DM8000Base (IBASE) • DM8700Base</p>	







Codes	Settings and Supported Devices	Codes
	<p>ALT+G specifically the left ALT key</p> <p>DM50 • DM60 • DM70 • DM8000 • DM8000Base (IBASE) • DM8700Base</p>	
	<p>ALT+H specifically the left ALT key</p> <p>DM50 • DM60 • DM70 • DM8000 • DM8000Base (IBASE) • DM8700Base</p>	
	<p>ALT+I specifically the left ALT key</p> <p>DM50 • DM60 • DM70 • DM8000 • DM8000Base (IBASE) • DM8700Base</p>	
	<p>ALT+J specifically the left ALT key</p> <p>DM50 • DM60 • DM70 • DM8000 • DM8000Base (IBASE) • DM8700Base</p>	
	<p>ALT+K specifically the left ALT key</p> <p>DM50 • DM60 • DM70 • DM8000 • DM8000Base (IBASE) • DM8700Base</p>	
	<p>ALT+L specifically the left ALT key</p> <p>DM50 • DM60 • DM70 • DM8000 • DM8000Base (IBASE) • DM8700Base</p>	
	<p>ALT+M specifically the left ALT key</p> <p>DM50 • DM60 • DM70 • DM8000 • DM8000Base (IBASE) • DM8700Base</p>	
	<p>ALT+N specifically the left ALT key</p> <p>DM50 • DM60 • DM70 • DM8000 • DM8000Base (IBASE) • DM8700Base</p>	
	<p>ALT+O specifically the left ALT key</p> <p>DM50 • DM60 • DM70 • DM8000 • DM8000Base (IBASE) • DM8700Base</p>	
	<p>ALT+P specifically the left ALT ke</p> <p>DM50 • DM60 • DM70 • DM8000 • DM8000Base (IBASE) • DM8700Base</p>	











Codes	Settings and Supported Devices	Codes
	<p>ALT+Q specifically the left ALT key</p> <p>DM50 • DM60 • DM70 • DM8000 • DM8000Base (IBASE) • DM8700Base</p>	
	<p>ALT+R specifically the left ALT key</p> <p>DM50 • DM60 • DM70 • DM8000 • DM8000Base (IBASE) • DM8700Base</p>	
	<p>ALT+S specifically the left ALT key</p> <p>DM50 • DM60 • DM70 • DM8000 • DM8000Base (IBASE) • DM8700Base</p>	
	<p>ALT+T specifically the left ALT key</p> <p>DM50 • DM60 • DM70 • DM8000 • DM8000Base (IBASE) • DM8700Base</p>	
	<p>ALT+U specifically the left ALT key</p> <p>DM50 • DM60 • DM70 • DM8000 • DM8000Base (IBASE) • DM8700Base</p>	
	<p>ALT+V specifically the left ALT key</p> <p>DM50 • DM60 • DM70 • DM8000 • DM8000Base (IBASE) • DM8700Base</p>	
	<p>ALT+W specifically the left ALT key</p> <p>DM50 • DM60 • DM70 • DM8000 • DM8000Base (IBASE) • DM8700Base</p>	
	<p>ALT+X specifically the left ALT key</p> <p>DM50 • DM60 • DM70 • DM8000 • DM8000Base (IBASE) • DM8700Base</p>	
	<p>ALT+Y specifically the left ALT key</p> <p>DM50 • DM60 • DM70 • DM8000 • DM8000Base (IBASE) • DM8700Base</p>	
	<p>ALT+Z specifically the left ALT key</p> <p>DM50 • DM60 • DM70 • DM8000 • DM8000Base (IBASE) • DM8700Base</p>	
	<p>PRINTSCREEN</p> <p>DM50 • DM60 • DM70 • DM8000 • DM8000Base (IBASE) • DM8700Base</p>	

Codes	Settings and Supported Devices	Codes
	<p>F1</p> <p>DM50 • DM60 • DM70 • DM8000 • DM8000Base (IBASE) • DM8700Base</p>	
	<p>F2</p> <p>DM50 • DM60 • DM70 • DM8000 • DM8000Base (IBASE) • DM8700Base</p>	
	<p>F3</p> <p>DM50 • DM60 • DM70 • DM8000 • DM8000Base (IBASE) • DM8700Base</p>	
	<p>F4</p> <p>DM50 • DM60 • DM70 • DM8000 • DM8000Base (IBASE) • DM8700Base</p>	
	<p>F5</p> <p>DM50 • DM60 • DM70 • DM8000 • DM8000Base (IBASE) • DM8700Base</p>	
	<p>F6</p> <p>DM50 • DM60 • DM70 • DM8000 • DM8000Base (IBASE) • DM8700Base</p>	
	<p>F7</p> <p>DM50 • DM60 • DM70 • DM8000 • DM8000Base (IBASE) • DM8700Base</p>	
	<p>F8</p> <p>DM50 • DM60 • DM70 • DM8000 • DM8000Base (IBASE) • DM8700Base</p>	
	<p>F9</p> <p>DM50 • DM60 • DM70 • DM8000 • DM8000Base (IBASE) • DM8700Base</p>	
	<p>F10</p> <p>DM50 • DM60 • DM70 • DM8000 • DM8000Base (IBASE) • DM8700Base</p>	
	<p>HOME</p> <p>DM50 • DM60 • DM70 • DM8000 • DM8000Base (IBASE) • DM8700Base</p>	
	<p>ARROW UP</p> <p>DM50 • DM60 • DM70 • DM8000 • DM8000Base (IBASE) • DM8700Base</p>	
	<p>PAGE UP</p> <p>DM50 • DM60 • DM70 • DM8000 • DM8000Base (IBASE) • DM8700Base</p>	



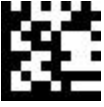







Codes	Settings and Supported Devices	Codes
	<p>ARROW LEFT</p> <p>DM50 • DM60 • DM70 • DM8000 • DM8000Base (IBASE) • DM8700Base</p>	
	<p>ARROW RIGHT</p> <p>DM50 • DM60 • DM70 • DM8000 • DM8000Base (IBASE) • DM8700Base</p>	
	<p>END</p> <p>DM50 • DM60 • DM70 • DM8000 • DM8000Base (IBASE) • DM8700Base</p>	
	<p>ARROW DOWN</p> <p>DM50 • DM60 • DM70 • DM8000 • DM8000Base (IBASE) • DM8700Base</p>	
	<p>PAGE DOWN</p> <p>DM50 • DM60 • DM70 • DM8000 • DM8000Base (IBASE) • DM8700Base</p>	
	<p>INSERT</p> <p>DM50 • DM60 • DM70 • DM8000 • DM8000Base (IBASE) • DM8700Base</p>	
	<p>DELETE</p> <p>DM50 • DM60 • DM70 • DM8000 • DM8000Base (IBASE) • DM8700Base</p>	
	<p>GUI LEFT</p> <p>DM50 • DM60 • DM70 • DM8000 • DM8000Base (IBASE) • DM8700Base</p>	
	<p>GUI RIGHT</p> <p>DM50 • DM60 • DM70 • DM8000 • DM8000Base (IBASE) • DM8700Base</p>	
	<p>ALT+F1 specifically the left ALT key</p> <p>DM50 • DM60 • DM70 • DM8000 • DM8000Base (IBASE) • DM8700Base</p>	
	<p>ALT+F2 specifically the left ALT key</p> <p>DM50 • DM60 • DM70 • DM8000 • DM8000Base (IBASE) • DM8700Base</p>	
	<p>ALT+F3 specifically the left ALT key</p> <p>DM50 • DM60 • DM70 • DM8000 • DM8000Base (IBASE) • DM8700Base</p>	



Codes	Settings and Supported Devices	Codes
	<p>ALT+F4 specifically the left ALT key</p> <p>DM50 • DM60 • DM70 • DM8000 • DM8000Base (IBASE) • DM8700Base</p>	
	<p>ALT+F5 specifically the left ALT key</p> <p>DM50 • DM60 • DM70 • DM8000 • DM8000Base (IBASE) • DM8700Base</p>	
	<p>ALT+F6 specifically the left ALT key</p> <p>DM50 • DM60 • DM70 • DM8000 • DM8000Base (IBASE) • DM8700Base</p>	
	<p>ALT+F7 specifically the left ALT key</p> <p>DM50 • DM60 • DM70 • DM8000 • DM8000Base (IBASE) • DM8700Base</p>	
	<p>ALT+F8 specifically the left ALT key</p> <p>DM50 • DM60 • DM70 • DM8000 • DM8000Base (IBASE) • DM8700Base</p>	
	<p>ALT+F9 specifically the left ALT key</p> <p>DM50 • DM60 • DM70 • DM8000 • DM8000Base (IBASE) • DM8700Base</p>	
	<p>ALT+F10 specifically the left ALT key</p> <p>DM50 • DM60 • DM70 • DM8000 • DM8000Base (IBASE) • DM8700Base</p>	
	<p>F11</p> <p>DM50 • DM60 • DM70 • DM8000 • DM8000Base (IBASE) • DM8700Base</p>	
	<p>F12</p> <p>DM50 • DM60 • DM70 • DM8000 • DM8000Base (IBASE) • DM8700Base</p>	
	<p>ALT+F11 specifically the left ALT key</p> <p>DM50 • DM60 • DM70 • DM8000 • DM8000Base (IBASE) • DM8700Base</p>	
	<p>ALT+F12 specifically the left ALT key</p> <p>DM50 • DM60 • DM70 • DM8000 • DM8000Base (IBASE) • DM8700Base</p>	



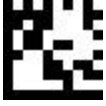

Codes	Settings and Supported Devices	Codes
	<p>ALT+ENTER specifically the left ALT key and main ENTER</p> <p>DM50 • DM60 • DM70 • DM8000 • DM8000Base (IBASE) • DM8700Base</p>	
	<p>CTRL+A specifically the right CTRL key</p> <p>DM50 • DM60 • DM70 • DM8000 • DM8000Base (IBASE) • DM8700Base</p>	
	<p>CTRL+B specifically the right CTRL key</p> <p>DM50 • DM60 • DM70 • DM8000 • DM8000Base (IBASE) • DM8700Base</p>	
	<p>CTRL+C specifically the right CTRL key</p> <p>DM50 • DM60 • DM70 • DM8000 • DM8000Base (IBASE) • DM8700Base</p>	
	<p>CTRL+D specifically the right CTRL key</p> <p>DM50 • DM60 • DM70 • DM8000 • DM8000Base (IBASE) • DM8700Base</p>	
	<p>CTRL+E specifically the right CTRL key</p> <p>DM50 • DM60 • DM70 • DM8000 • DM8000Base (IBASE) • DM8700Base</p>	
	<p>CTRL+F specifically the right CTRL key</p> <p>DM50 • DM60 • DM70 • DM8000 • DM8000Base (IBASE) • DM8700Base</p>	
	<p>CTRL+G specifically the right CTRL key</p> <p>DM50 • DM60 • DM70 • DM8000 • DM8000Base (IBASE) • DM8700Base</p>	
	<p>CTRL+H specifically the right CTRL key</p> <p>DM50 • DM60 • DM70 • DM8000 • DM8000Base (IBASE) • DM8700Base</p>	
	<p>CTRL+I specifically the right CTRL key</p> <p>DM50 • DM60 • DM70 • DM8000 • DM8000Base (IBASE) • DM8700Base</p>	

Codes	Settings and Supported Devices	Codes
	<p>CTRL+J specifically the right CTRL key</p> <p>DM50 • DM60 • DM70 • DM8000 • DM8000Base (IBASE) • DM8700Base</p>	
	<p>CTRL+K specifically the right CTRL key</p> <p>DM50 • DM60 • DM70 • DM8000 • DM8000Base (IBASE) • DM8700Base</p>	
	<p>CTRL+L specifically the right CTRL key</p> <p>DM50 • DM60 • DM70 • DM8000 • DM8000Base (IBASE) • DM8700Base</p>	
	<p>CTRL+M specifically the right CTRL key</p> <p>DM50 • DM60 • DM70 • DM8000 • DM8000Base (IBASE) • DM8700Base</p>	
	<p>CTRL+N specifically the right CTRL key</p> <p>DM50 • DM60 • DM70 • DM8000 • DM8000Base (IBASE) • DM8700Base</p>	
	<p>CTRL+O specifically the right CTRL key</p> <p>DM50 • DM60 • DM70 • DM8000 • DM8000Base (IBASE) • DM8700Base</p>	
	<p>CTRL+P specifically the right CTRL key</p> <p>DM50 • DM60 • DM70 • DM8000 • DM8000Base (IBASE) • DM8700Base</p>	
	<p>CTRL+Q specifically the right CTRL key</p> <p>DM50 • DM60 • DM70 • DM8000 • DM8000Base (IBASE) • DM8700Base</p>	
	<p>CTRL+R specifically the right CTRL key</p> <p>DM50 • DM60 • DM70 • DM8000 • DM8000Base (IBASE) • DM8700Base</p>	
	<p>CTRL+S specifically the right CTRL key</p> <p>DM50 • DM60 • DM70 • DM8000 • DM8000Base (IBASE) • DM8700Base</p>	

Codes	Settings and Supported Devices	Codes
	<p>CTRL+T specifically the right CTRL key</p> <p>DM50 • DM60 • DM70 • DM8000 • DM8000Base (IBASE) • DM8700Base</p>	
	<p>CTRL+U specifically the right CTRL key</p> <p>DM50 • DM60 • DM70 • DM8000 • DM8000Base (IBASE) • DM8700Base</p>	
	<p>CTRL+V specifically the right CTRL key</p> <p>DM50 • DM60 • DM70 • DM8000 • DM8000Base (IBASE) • DM8700Base</p>	
	<p>CTRL+W specifically the right CTRL key</p> <p>DM50 • DM60 • DM70 • DM8000 • DM8000Base (IBASE) • DM8700Base</p>	
	<p>CTRL+X specifically the right CTRL key</p> <p>DM50 • DM60 • DM70 • DM8000 • DM8000Base (IBASE) • DM8700Base</p>	
	<p>CTRL+Y specifically the right CTRL key</p> <p>DM50 • DM60 • DM70 • DM8000 • DM8000Base (IBASE) • DM8700Base</p>	
	<p>CTRL+Z specifically the right CTRL key</p> <p>DM50 • DM60 • DM70 • DM8000 • DM8000Base (IBASE) • DM8700Base</p>	
	<p>CTRL+F1 specifically the right CTRL key</p> <p>DM50 • DM60 • DM70 • DM8000 • DM8000Base (IBASE) • DM8700Base</p>	
	<p>CTRL+F2 specifically the right CTRL key</p> <p>DM50 • DM60 • DM70 • DM8000 • DM8000Base (IBASE) • DM8700Base</p>	
	<p>CTRL+F3 specifically the right CTRL key</p> <p>DM50 • DM60 • DM70 • DM8000 • DM8000Base (IBASE) • DM8700Base</p>	

Codes	Settings and Supported Devices	Codes
	<p>CTRL+F4 specifically the right CTRL key</p> <p>DM50 • DM60 • DM70 • DM8000 • DM8000Base (IBASE) • DM8700Base</p>	
	<p>CTRL+F5 specifically the right CTRL key</p> <p>DM50 • DM60 • DM70 • DM8000 • DM8000Base (IBASE) • DM8700Base</p>	
	<p>CTRL+F6 specifically the right CTRL key</p> <p>DM50 • DM60 • DM70 • DM8000 • DM8000Base (IBASE) • DM8700Base</p>	
	<p>CTRL+F7 specifically the right CTRL key</p> <p>DM50 • DM60 • DM70 • DM8000 • DM8000Base (IBASE) • DM8700Base</p>	
	<p>CTRL+F8 specifically the right CTRL key</p> <p>DM50 • DM60 • DM70 • DM8000 • DM8000Base (IBASE) • DM8700Base</p>	
	<p>CTRL+F9 specifically the right CTRL key</p> <p>DM50 • DM60 • DM70 • DM8000 • DM8000Base (IBASE) • DM8700Base</p>	
	<p>CTRL+F10 specifically the right CTRL key</p> <p>DM50 • DM60 • DM70 • DM8000 • DM8000Base (IBASE) • DM8700Base</p>	
	<p>CTRL+F11 specifically the right CTRL key</p> <p>DM50 • DM60 • DM70 • DM8000 • DM8000Base (IBASE) • DM8700Base</p>	
	<p>CTRL+F12 specifically the right CTRL key</p> <p>DM50 • DM60 • DM70 • DM8000 • DM8000Base (IBASE) • DM8700Base</p>	
	<p>CTRL+ENTER specifically the right CTRL key and main ENTER</p> <p>DM50 • DM60 • DM70 • DM8000 • DM8000Base (IBASE) • DM8700Base</p>	

Codes	Settings and Supported Devices	Codes
	<p style="text-align: center;">CTRL specifically the right CTRL key</p> <p>DM50 • DM60 • DM70 • DM8000 • DM8000Base (IBASE) • DM8700Base</p>	
	<p style="text-align: center;">SHIFT+F1 specifically the left SHIFT key</p> <p>DM50 • DM60 • DM70 • DM8000 • DM8000Base (IBASE) • DM8700Base</p>	
	<p style="text-align: center;">SHIFT+F2 specifically the left SHIFT key</p> <p>DM50 • DM60 • DM70 • DM8000 • DM8000Base (IBASE) • DM8700Base</p>	
	<p style="text-align: center;">SHIFT+F3 specifically the left SHIFT key</p> <p>DM50 • DM60 • DM70 • DM8000 • DM8000Base (IBASE) • DM8700Base</p>	
	<p style="text-align: center;">SHIFT+F4 specifically the left SHIFT key</p> <p>DM50 • DM60 • DM70 • DM8000 • DM8000Base (IBASE) • DM8700Base</p>	
	<p style="text-align: center;">SHIFT+F5 specifically the left SHIFT key</p> <p>DM50 • DM60 • DM70 • DM8000 • DM8000Base (IBASE) • DM8700Base</p>	
	<p style="text-align: center;">SHIFT+F6 specifically the left SHIFT key</p> <p>DM50 • DM60 • DM70 • DM8000 • DM8000Base (IBASE) • DM8700Base</p>	
	<p style="text-align: center;">SHIFT+F7 specifically the left SHIFT key</p> <p>DM50 • DM60 • DM70 • DM8000 • DM8000Base (IBASE) • DM8700Base</p>	
	<p style="text-align: center;">SHIFT+F8 specifically the left SHIFT key</p> <p>DM50 • DM60 • DM70 • DM8000 • DM8000Base (IBASE) • DM8700Base</p>	
	<p style="text-align: center;">SHIFT+F9 specifically the left SHIFT key</p> <p>DM50 • DM60 • DM70 • DM8000 • DM8000Base (IBASE) • DM8700Base</p>	

Codes	Settings and Supported Devices	Codes
	<p style="text-align: center;">SHIFT+F10 specifically the left SHIFT key</p> <p>DM50 • DM60 • DM70 • DM8000 • DM8000Base (IBASE) • DM8700Base</p>	
	<p style="text-align: center;">SHIFT+F11 specifically the left SHIFT key</p> <p>DM50 • DM60 • DM70 • DM8000 • DM8000Base (IBASE) • DM8700Base</p>	
	<p style="text-align: center;">SHIFT+F12 specifically the left SHIFT key</p> <p>DM50 • DM60 • DM70 • DM8000 • DM8000Base (IBASE) • DM8700Base</p>	
	<p style="text-align: center;">SHIFT+ENTER specifically the left SHIFT key and main ENTER</p> <p>DM50 • DM60 • DM70 • DM8000 • DM8000Base (IBASE) • DM8700Base</p>	

iOS Keyboard Configuration





Codes	Settings and Supported Devices	Codes
	<p>Enable iOS Keyboard Emulation</p> <p>MX-1000 • MX-1502</p>	
	<p>Disable iOS Keyboard Emulation</p> <p>MX-1000 • MX-1502</p>	
	<p>Set iOS Keyboard Warm-Up Time to 300ms</p> <p>MX-1000 • MX-1502</p>	
	<p>Set iOS Keyboard Warm-Up Time to 500ms</p> <p>MX-1000 • MX-1502</p>	
	<p>Set iOS Keyboard Warm-Up Time to 1000ms</p> <p>MX-1000 • MX-1502</p>	

USB Connection

Codes	Settings and Supported Devices	Codes
	<p>*USB-COM/RS-232</p> <p>DM50 • DM60 • DM70 • DM150 • DM8050 • DM8072 • DM8600 • MX-1000 • MX-1502</p>	
	<p>USB Keyboard</p> <p>DM50 • DM60 • DM70 • DM150 • DM8050 • DM8072 • DM8600 • MX-1000 • MX-1502</p>	
	<p>Enable USB Keyboard for the base station</p> <p><i>Reboot needed for enabling USB keyboard for the base station!</i></p> <p>DM8000Base (IBASE)</p>	
	<p>*Disable USB Keyboard for the base station</p> <p><i>Reboot needed after disabling USB keyboard for the base station!</i></p> <p>DM8000Base (IBASE)</p>	
	<p>Enable 'Enumerate in HID mode only'</p> <p><i>Reboot needed for changing between HID and USB mode of base/reader!</i></p> <p>DM8000Base (IBASE)</p>	

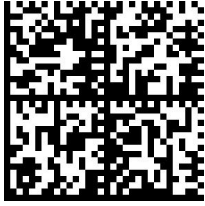
Codes	Settings and Supported Devices	Codes
	<p>Disable 'Enumerate in HID mode only'</p> <p><i>Reboot needed for changing between HID and USB mode of base/reader!</i></p> <p>DM8000Base (IBASE)</p>	
	<p>Enable HID mode (USB Keyboard)</p> <p><i>No restart required, device does not lose cdc communication channel.</i></p> <p>DM8700</p>	
	<p>Disable HID mode (USB Keyboard)</p> <p><i>No restart required, device does not lose cdc communication channel.</i></p> <p>DM8700</p>	
	<p>Enable HID mode (USB Keyboard)</p> <p>DM8700Base</p>	
	<p>Disable HID mode (USB Keyboard)</p> <p>DM8700Base</p>	

Codes	Settings and Supported Devices	Codes
	<p>*Enable Base USB</p> <p><i>Reader switches to USB when in the base.</i></p> <p>DM8000Base (IBASE)</p>	
	<p>Disable Base USB</p> <p><i>Reader keeps up WiFi even when in the base.</i></p> <p>DM8000Base (IBASE Wi-Fi)</p>	
	<p>Enable Re-enumeration on Firmware Start</p> <p>DM50 • DM60 • DM70 • DM150</p>	
	<p>Disable Re-enumeration on Firmware Start</p> <p>DM50 • DM60 • DM70 • DM150</p>	
	<p>DTR Assertion Required for USB communication</p> <p>DM8050 • DM8700 corded</p>	



Codes	Settings and Supported Devices	Codes
	<p>DTR Assertion Not Required for USB communication</p> <p>DM8050 • DM8700 corded</p>	
	<p>DTR Assertion Required for USB communication for Base Station</p> <p>DM8700Base</p>	
	<p>DTR Assertion Not Required for USB communication for Base Station</p> <p>DM8700Base</p>	
	<p>HID Ignore Caps Lock ON</p> <p>DM8700</p>	
	<p>HID Ignore Caps Lock OFF</p> <p>DM8700</p>	

USB Mode



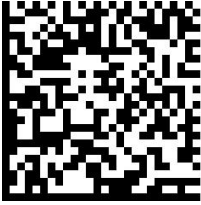

Codes	Settings and Supported Devices	Codes
	USB compatibility mode enabled (Not supported on DM8700) DM50 • DM70 • DM8000	
	*USB compatibility mode disabled (Not supported on DM8700) DM50 • DM70 • DM8000	
	USB compatibility mode enabled DM8000Base (IBASE)	
	USB compatibility mode disabled DM8000Base (IBASE)	
	USB 2.0 mode (Not supported on DM8700) DM50 • DM70 • DM150 • DM8000	

Codes	Settings and Supported Devices	Codes
	<p>*USB 1.1 mode (Not supported on DM8700)</p> <p>DM50 • DM70 • DM150 • DM8000</p>	
	<p>USB 2.0 mode on base station</p> <p>DM50 • DM70 • DM150 • DM8000Base (IBASE)</p>	
	<p>*USB 1.1 mode on base station (Not supported on DM8700)</p> <p>DM50 • DM70 • DM150 • DM8000Base (IBASE)</p>	
	<p>Android Mode (default)</p> <p>MX-1000 • MX-1502</p>	
	<p>iOS Mode</p> <p>MX-1000 • MX-1502</p>	

Communications





Codes	Settings and Supported Devices	Codes
	<p>*Enable DHCP (default for all Ethernet readers)</p> <p>DM60 • DM150 • DM260 • DM300 • DM360 • DM370 • DM470 • DM503 • DM8000</p> <p>DO NOT SCAN this code with a DM8000 wireless reader!</p>	
	<p>Enable Multi-Port (RS-232 Sharing)</p> <p>DM50 • DM60 • DM70 • DM150 • DM260 • DM300 • DM360 • DM370 • DM470 • DM503</p>	
	<p>*Disable Multi-Port (RS-232 Sharing)</p> <p>DM50 • DM60 • DM70 • DM150 • DM260 • DM300 • DM360 • DM370 • DM470 • DM503</p>	
	<p>Enable EtherNet/IP</p> <p>DM60 • DM150 • DM260 • DM300 • DM360 • DM370 • DM470 • DM503 • DM8000 (corded)</p>	



Codes	Settings and Supported Devices	Codes
	<p>Enable EtherNet/IP</p> <p>DM8000Base (IBASE BT + Wi-Fi) • DM8700Base</p>	
	<p>*Disable EtherNet/IP</p> <p>DM60 • DM150 • DM260 • DM300 • DM360 • DM370 • DM470 • DM503 • DM8000 (corded)</p>	
	<p>*Disable EtherNet/IP</p> <p>DM8000Base (IBASE BT + Wi-Fi) • DM8700Base</p>	
	<p>Enable PROFINET</p> <p>DM60 • DM150 • DM260 • DM300 • DM360 • DM370 • DM470 • DM503 • DM8000 (corded)</p>	
	<p>Enable PROFINET</p> <p>DM8000Base (IBASE BT + Wi-Fi) • DM8700Base</p>	

Codes	Settings and Supported Devices	Codes
	<p>*Disable PROFINET</p> <p>DM60 • DM150 • DM260 • DM300 • DM360 • DM370 • DM470 • DM503 • DM8000 (corded)</p>	
	<p>*Disable PROFINET</p> <p>DM8000Base (IBASE BT + Wi-Fi) • DM8700Base</p>	
	<p>Enable Modbus TCP</p> <p>DM60 • DM150 • DM260 • DM300 • DM360 • DM370 • DM470 • DM503 • DM8000 (corded)</p>	
	<p>Enable Modbus TCP</p> <p>DM8000Base (IBASE BT + Wi-Fi) • DM8700Base</p>	
	<p>*Disable Modbus TCP</p> <p>DM60 • DM150 • DM260 • DM300 • DM360 • DM370 • DM470 • DM503 • DM8000 (corded)</p>	



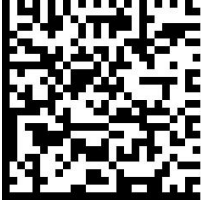

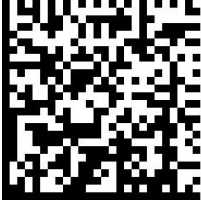
Codes	Settings and Supported Devices	Codes
	<p>*Disable Modbus TCP</p> <p>DM8000Base (IBASE BT + Wi-Fi) • DM8700Base</p>	
	<p>Enable SLMP Protocol</p> <p>DM60 • DM150 • DM260 • DM300 • DM360 • DM370 • DM470 • DM503 • DM8000 (corded)</p>	
	<p>Enable SLMP Protocol</p> <p>DM8000Base (IBASE BT + Wi-Fi) • DM8700Base</p>	
	<p>*Disable SLMP Protocol</p> <p>DM60 • DM150 • DM260 • DM300 • DM360 • DM370 • DM470 • DM503 • DM8000 (corded)</p>	
	<p>*Disable SLMP Protocol</p> <p>DM8000Base (IBASE BT + Wi-Fi) • DM8700Base</p>	

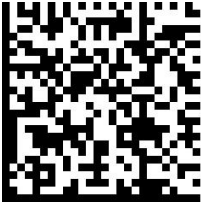
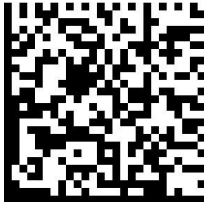



RS-232 Baud Rate

Codes	Settings and Supported Devices	Codes
	<p>9600 BPS</p> <p>DM50 • DM60 • DM70 • DM150 • DM260 • DM300 • DM360 • DM370 • DM470 • DM503 • DM8000 (corded)</p>	
	<p>9600 BPS</p> <p>DM8000Base (IBASE BT + Wi-Fi) • DM8700Base</p>	
	<p>19200 BPS</p> <p>DM50 • DM60 • DM70 • DM150 • DM260 • DM300 • DM360 • DM370 • DM470 • DM503 • DM8000 (corded)</p>	
	<p>19200 BPS</p> <p>DM8000Base (IBASE BT + Wi-Fi) • DM8700Base</p>	
	<p>38400 BPS</p> <p>DM50 • DM60 • DM70 • DM150 • DM260 • DM300 • DM360 • DM370 • DM470 • DM503 • DM8000 (corded)</p>	





Codes	Settings and Supported Devices	Codes
	<p>38400 BPS</p> <p>DM8000Base (IBASE BT + Wi-Fi) • DM8700Base</p>	
	<p>*57600 BPS (default for DMAE50, DM300, DM360, DM470 and DM8000)</p> <p>DM50 • DM60 • DM70 • DM150 • DM260 • DM300 • DM360 • DM370 • DM470 • DM503 • DM8000 (corded)</p>	
	<p>57600 BPS</p> <p>DM8000Base (IBASE BT + Wi-Fi)</p>	
	<p>*115200 BPS (default for DM50, DM60, DM70, DM150, DM260, and DM503)</p> <p>DM50 • DM60 • DM70 • DM150 • DM260 • DM300 • DM360 • DM370 • DM470 • DM503 • DM8050 • DM8600</p>	
	<p>115200 BPS</p> <p>DM8000Base (IBASE BT + Wi-Fi) • DM8700Base</p>	

RS-232 Parity Settings





Codes	Settings and Supported Devices	Codes
	<p>None</p> <p>All readers</p>	
	<p>None</p> <p>DM8000Base (IBASE BT + Wi-Fi) • DM8700Base</p>	
	<p>Odd</p> <p>All readers</p>	
	<p>Odd</p> <p>DM8000Base (IBASE BT + Wi-Fi) • DM8700Base</p>	
	<p>Even</p> <p>All readers</p>	

Codes	Settings and Supported Devices	Codes
	<p>Even</p> <p>DM8000Base (IBASE BT + Wi-Fi) • DM8700Base</p>	
	<p>Mark</p> <p>DM8050 • DM8600</p>	
	<p>Mark</p> <p>DM8000Base (IBASE BT + Wi-Fi) • DM8700Base</p>	
	<p>Space</p> <p>DM8050 • DM8600</p>	
	<p>Space</p> <p>DM8000Base (IBASE BT + Wi-Fi) • DM8700Base</p>	





RS-232 Databit Settings

Codes	Settings and Supported Devices	Codes
	<p style="text-align: center;">Databit 7</p> <p>DM50 • DM60 • DM70 • DM150 • DM260 • DM300 • DM360 • DM370 • DM470 • DM503 • DM8000 (corded)</p>	
	<p style="text-align: center;">Databit 7</p> <p>DM8000Base (IBASE BT + Wi-Fi) • DM8700Base</p>	
	<p style="text-align: center;">Databit 8</p> <p>DM50 • DM60 • DM70 • DM150 • DM260 • DM300 • DM360 • DM370 • DM470 • DM503 • DM8000 (corded)</p>	
	<p style="text-align: center;">Databit 8</p> <p>DM8000Base (IBASE BT + Wi-Fi) • DM8700Base</p>	



RS-232 Stopbit Settings

Codes	Settings and Supported Devices	Codes
	<p style="text-align: center;">Stopbit 1</p> <p>DM50 • DM60 • DM70 • DM150 • DM260 • DM300 • DM360 • DM370 • DM470 • DM503 • DM8000 (corded)</p>	
	<p style="text-align: center;">Stopbit 1</p> <p>DM8000Base (IBASE BT + Wi-Fi) • DM8700Base</p>	
	<p style="text-align: center;">Stopbit 2</p> <p>DM50 • DM60 • DM70 • DM150 • DM260 • DM300 • DM360 • DM370 • DM470 • DM503 • DM8000 (corded)</p>	
	<p style="text-align: center;">Stopbit 2</p> <p>DM8000Base (IBASE BT + Wi-Fi) • DM8700Base</p>	

RS-232 Handshaking

Codes	Settings and Supported Devices	Codes
	<p>*RTS/CTS Off</p> <p>DM8000 (corded)</p>	
	<p>RTS/CTS Off</p> <p>DM8000Base (IBASE BT + Wi-Fi) • DM8700Base</p>	
	<p>RTS/CTS On</p> <p>DM8000 (corded)</p>	
	<p>RTS/CTS On</p> <p>DM8000Base (IBASE BT + Wi-Fi) • DM8700Base</p>	

RS-232 Routing

Codes	Settings and Supported Devices	Codes
	<p>*Route to associated reader (Not supported on DM8700)</p> <p>DM8000 (wireless)</p>	
	<p>Route to base station (Not supported on DM8700)</p> <p>DM8000 (wireless)</p>	



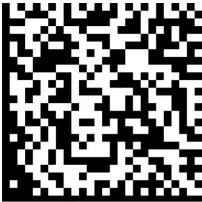

Network Settings

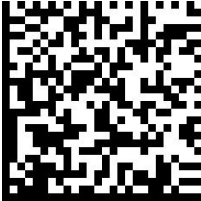
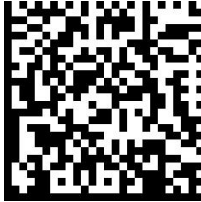
Codes	Settings and Supported Devices	Codes
	<p>Enable Network Client (only corded Ethernet connections)</p> <p>DM60 • DM150 • DM260 • DM300 • DM360 • DM370 • DM470 • DM503 • DM8000</p>	
	<p>*Disable Network Client (only corded Ethernet connections)</p> <p>DM60 • DM150 • DM260 • DM300 • DM360 • DM370 • DM470 • DM503 • DM8000</p>	



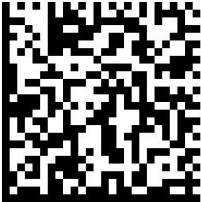

Decode Settings





Codes	Settings and Supported Devices	Codes
	<p>*Never Read the Same Code Twice Off</p> <p>DM50 • DM60 • DM70 • DM150 • DM260 • DM300 • DM360 • DM370 • DM470 • DM503 • DM8000</p>	
	<p>Never Read the Same Code Twice On</p> <p>DM50 • DM60 • DM70 • DM150 • DM260 • DM300 • DM360 • DM370 • DM470 • DM503 • DM8000</p>	





Multi-Reader Sync





Codes	Settings and Supported Devices	Codes
	<p>Enable MRS</p> <p>DM60 • DM150 • DM260 • DM300 • DM360 • DM370 • DM470 • DM503</p>	
	<p>*Disable MRS</p> <p>DM60 • DM150 • DM260 • DM300 • DM360 • DM370 • DM470 • DM503</p>	
	<p>Select Reader as Primary Reader</p> <p>DM60 • DM150 • DM260 • DM300 • DM360 • DM370 • DM470 • DM503</p>	
	<p>Deselect Reader as Primary Reader</p> <p>DM60 • DM150 • DM260 • DM300 • DM360 • DM370 • DM470 • DM503</p>	

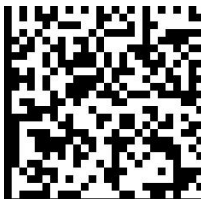



Keyboard Layout

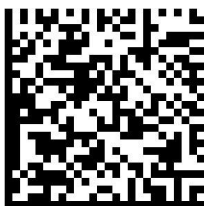

Codes	Settings and Supported Devices	Codes
	<p>*USA</p> <p>DM50 • DM60 • DM70 • DM150 • DM260 • DM8000 • DM8700</p>	
	<p>*USA</p> <p>DM8000Base (IBASE BT + Wi-Fi) • DM8700Base</p>	
	<p>Germany</p> <p>DM50 • DM60 • DM70 • DM150 • DM260 • DM8000 • DM8700</p>	
	<p>Germany</p> <p>DM8000Base (IBASE BT + Wi-Fi) • DM8700Base</p>	
	<p>France</p> <p>DM50 • DM60 • DM70 • DM150 • DM260 • DM8000 • DM8700</p>	

Codes	Settings and Supported Devices	Codes
	<p style="text-align: center;">France</p> <p style="text-align: center;">DM8000Base (IBASE BT + Wi-Fi) • DM8700Base</p>	
	<p style="text-align: center;">Spain</p> <p style="text-align: center;">DM50 • DM60 • DM70 • DM150 • DM260 • DM8000 • DM8700</p>	
	<p style="text-align: center;">Spain</p> <p style="text-align: center;">DM8000Base (IBASE BT + Wi-Fi) • DM8700Base</p>	
	<p style="text-align: center;">Japan</p> <p style="text-align: center;">DM50 • DM60 • DM70 • DM150 • DM260 • DM8000 • DM8700</p>	
	<p style="text-align: center;">Japan</p> <p style="text-align: center;">DM8000Base (IBASE BT + Wi-Fi) • DM8700Base</p>	

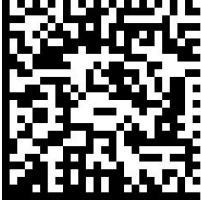

Codes	Settings and Supported Devices	Codes
	<p>Norway</p> <p>DM50 • DM60 • DM70 • DM150 • DM260 • DM8000</p>	
	<p>Norway</p> <p>DM8000Base (IBASE BT + Wi-Fi) • DM8700Base</p>	
	<p>Finland</p> <p>DM50 • DM60 • DM70 • DM150 • DM260 • DM8000</p>	
	<p>Finland</p> <p>DM8000Base (IBASE BT + Wi-Fi) • DM8700Base</p>	
	<p>Czech Republic</p> <p>DM50 • DM60 • DM70 • DM150 • DM260 • DM8700</p>	

Codes	Settings and Supported Devices	Codes
	<p>Czech Republic</p> <p>DM8700Base</p>	
	<p>Hungary</p> <p>DM50 • DM60 • DM70 • DM150 • DM260 • DM8700</p>	
	<p>Hungary</p> <p>DM8700Base</p>	
	<p>Italy</p> <p>DM50 • DM60 • DM70 • DM150 • DM260 • DM8700</p>	
	<p>Italy</p> <p>DM8700Base</p>	





Codes	Settings and Supported Devices	Codes
	<p>Set HID Language to Spanish (ES) (Xkb)</p> <p>DM50 • DM60 • DM70 • DM150 • DM260</p>	
	<p>Set HID Language to Czech (CZ) (Xkb)</p> <p>DM50 • DM60 • DM70 • DM150 • DM260</p>	
	<p>Set HID Language to Italian (IT) (Xkb)</p> <p>DM50 • DM60 • DM70 • DM150 • DM260</p>	
	<p>Set HID Language to English (UK) (Xkb)</p> <p>DM50 • DM60 • DM70 • DM150 • DM260</p>	
	<p>Set HID Language to Portuguese (BR) (Xkb)</p> <p>DM50 • DM60 • DM70 • DM150 • DM260</p>	

Codes	Settings and Supported Devices	Codes
	<p>Set HID Language to Spanish (MX) (Xkb)</p> <p>DM50 • DM60 • DM70 • DM150 • DM260</p>	
	<p>Alt Key Combo</p> <p>DM50 • DM70 • DM8000</p>	
	<p>Alt Key Combo</p> <p>DM8000Base (IBASE BT + Wi-Fi) • DM8700Base</p>	



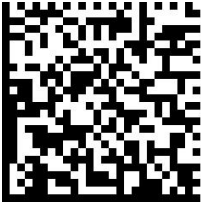

Alt Key Combo Zero Padding





Codes	Settings and Supported Devices	Codes
	<p>*Enable Alt Key Combo Zero Padding</p> <p>DM50 • DM70 • DM8000</p>	
	<p>*Enable Alt Key Combo Zero Padding</p> <p>DM8000Base (IBASE BT + Wi-Fi) • DM8700Base</p>	
	<p>Disable Alt Key Combo Zero Padding</p> <p>DM50 • DM70 • DM8000</p>	
	<p>Disable Alt Key Combo Zero Padding</p> <p>DM8000Base (IBASE BT + Wi-Fi) • DM8700Base</p>	





USB Keyboard Inter-Character Delay

Codes	Settings and Supported Devices	Codes
	<p>*0 ms OFF</p> <p>DM50 • DM70 • DM8000</p>	
	<p>100 ms ON</p> <p>DM50 • DM70 • DM8000</p>	
	<p>*0 ms OFF</p> <p>DM8000Base (IBASE) • DM8700Base</p>	
	<p>100 ms ON</p> <p>DM8000Base (IBASE) • DM8700Base</p>	

WebHMI Commands

Codes	Settings and Supported Devices	Codes
	<p>Enable WebHMI</p> <p>DM370 • DM470</p>	
	<p>Disable WebHMI</p> <p>DM370 • DM470</p>	
	<p>Enable WebHMI Actions Menu</p> <p>DM370 • DM470</p>	
	<p>Disable WebHMI Actions Menu</p> <p>DM370 • DM470</p>	
	<p>Enable WebHMI Settings Menu</p> <p>DM370 • DM470</p>	

Codes	Settings and Supported Devices	Codes
	<p>Disable WebHMI Settings Menu</p> <p>DM370 • DM470</p>	
	<p>Enable WebHMI Match String Menu</p> <p>DM370 • DM470</p>	
	<p>Disable WebHMI Match String Menu</p> <p>DM370 • DM470</p>	
	<p>Set WebHMI Language to German</p> <p>DM370 • DM470</p>	
	<p>Set WebHMI Language to English (US)</p> <p>DM370 • DM470</p>	

Codes	Settings and Supported Devices	Codes
	<p>Set WebHMI Language to Spanish</p> <p>DM370 • DM470</p>	
	<p>Set WebHMI Language to French</p> <p>DM370 • DM470</p>	
	<p>Set WebHMI Language to Japanese</p> <p>DM370 • DM470</p>	
	<p>Set WebHMI Language to Korean</p> <p>DM370 • DM470</p>	
	<p>Set WebHMI Language to Portuguese (BR)</p> <p>DM370 • DM470</p>	

Codes	Settings and Supported Devices	Codes
	<p data-bbox="579 216 959 243">Set WebHMI Language to Chinese</p> <p data-bbox="674 359 863 386">DM370 • DM470</p>	

