

COGNEX

DataMan[®] 8700 Reference Manual



2021 August 24
Revision: 6.1.10-SR3.2

Legal Notices

The software described in this document is furnished under license, and may be used or copied only in accordance with the terms of such license and with the inclusion of the copyright notice shown on this page. Neither the software, this document, nor any copies thereof may be provided to, or otherwise made available to, anyone other than the licensee. Title to, and ownership of, this software remains with Cognex Corporation or its licensor. Cognex Corporation assumes no responsibility for the use or reliability of its software on equipment that is not supplied by Cognex Corporation. Cognex Corporation makes no warranties, either express or implied, regarding the described software, its merchantability, non-infringement or its fitness for any particular purpose.

The information in this document is subject to change without notice and should not be construed as a commitment by Cognex Corporation. Cognex Corporation is not responsible for any errors that may be present in either this document or the associated software.

Companies, names, and data used in examples herein are fictitious unless otherwise noted. No part of this document may be reproduced or transmitted in any form or by any means, electronic or mechanical, for any purpose, nor transferred to any other media or language without the written permission of Cognex Corporation.

Copyright © 2021. Cognex Corporation. All Rights Reserved.

Portions of the hardware and software provided by Cognex may be covered by one or more U.S. and foreign patents, as well as pending U.S. and foreign patents listed on the Cognex web site at: cognex.com/patents.

The following are registered trademarks of Cognex Corporation:

Cognex, 2DMAX, Advantage, AlignPlus, Assemblyplus, Check it with Checker, Checker, Cognex Vision for Industry, Cognex VSOC, CVL, DataMan, DisplayInspect, DVT, EasyBuilder, Hotbars, IDMax, In-Sight, Laser Killer, MVS-8000, OmniView, PatFind, PatFlex, PatInspect, PatMax, PatQuick, SensorView, SmartView, SmartAdvisor, SmartLearn, UltraLight, Vision Solutions, VisionPro, VisionView

The following are trademarks of Cognex Corporation:

The Cognex logo, 1DMax, 3D-Locate, 3DMax, BGAll, CheckPoint, Cognex VSoC, CVC-1000, FFD, iLearn, In-Sight (design insignia with cross-hairs), In-Sight 2000, InspectEdge, Inspection Designer, MVS, NotchMax, OCRMax, PatMax RedLine, ProofRead, SmartSync, ProfilePlus, SmartDisplay, SmartSystem, SMD4, VisiFlex, Xpand

Portions copyright © Microsoft Corporation. All rights reserved.

Portions copyright © MadCap Software, Inc. All rights reserved.

Other product and company trademarks identified herein are the trademarks of their respective owners.

Table of Contents

Legal Notices	2
Table of Contents	3
Symbols	5
Precautions	6
Getting Started	7
About DataMan 8700	7
DataMan 8700 Accessories	8
Miscellaneous Accessories	8
Cables	9
Physical Layout of the Reader	10
OLED Display Layout	11
Physical Layout of the Base Station	12
Setting up Your DataMan 8700	13
Setting up the Reader Setting Up the Verifier	13
Install the DataMan SetupTool and Connect to Reader	13
DataMan 8700 Specifications	13
DataMan 8700 Imager Specifications	15
DataMan DataMan 8700 Base Station Specifications	15
LED Wavelengths for DataMan 8700 DX Reader	15
Connection Options	16
Connecting Corded DataMan 8700	16
Troubleshooting an Ethernet Connection	16
Using Your Device Through USB	16
Changing Communication in DataMan 8700 Corded Reader	17
Using DataMan 8700 Wireless Reader	21
Connecting to a Wireless DataMan 8700 Through Base Station	21
Pairing Wireless Readers to Base Station	22
Base Station Connection Options	22
Base Station Routing Capabilities	23
Buffering Data	23
Summary of Wireless Buffering Indicators	25
Charging	26
Changing Batteries	27
Reading Codes with the DataMan 8700	29
Industrial Protocols	29
Trigger Types	29
Field of View and Reading Distances	30
Cleaning and Maintenance	32
Cleaning the Reader Housing	32
Cleaning the Reader Lens Cover	32
Compliance Information, Warnings and Notices	33
Regulations and Conformity	33

Compliance Statements: DataMan Base Station	35
For European Community Users	36
中国大陆 RoHS (Information for China RoHS Compliance)	36

Symbols

The following symbols indicate safety precautions and supplemental information:

 **WARNING:** This symbol indicates a hazard that could cause death, serious personal injury or electrical shock.

 **CAUTION:** This symbol indicates a hazard that could result in property damage.

 **Note:** This symbol indicates additional information about a subject.

 **Tip:** This symbol indicates suggestions and shortcuts that might not otherwise be apparent.

Precautions

To reduce the risk of injury or equipment damage, observe the following precautions when you install the Cognex product:

- This product is intended for industrial use in automated manufacturing or similar applications.
- The safety of any system incorporating this product is the responsibility of the assembler of the system.
- This product does not contain user-serviceable parts. Do not make electrical or mechanical modifications to product components. Unauthorized modifications can void your warranty.
- Route cables and wires away from high-current wiring or high-voltage power sources to reduce the risk of damage or malfunction from the following causes: over-voltage, line noise, electrostatic discharge (ESD), power surges, or other irregularities in the power supply.
- Changes or modifications not expressly approved by the party responsible for regulatory compliance could void the user's authority to operate the equipment.
- Ensure that the cable bend radius begins at least six inches from the connector. Cable shielding can be degraded or cables can be damaged or wear out faster if a service loop or bend radius is tighter than 10X the cable diameter.
- This device should be used in accordance with the instructions in this manual.
- All specifications are for reference purposes only and can change without notice.
- This product is intended for industrial use in automated manufacturing or similar applications.
- The safety of any system incorporating this product is the responsibility of the assembler of the system.
- This product does not contain user-serviceable parts. Do not make electrical or mechanical modifications to product components. Unauthorized modifications can void your warranty.

Getting Started

About DataMan 8700



The DataMan 8700 readers offer a rugged, industrial housing and advanced technology for reading 1-D and 2-D codes regardless of size, quality, printing method or surface. DataMan 8700 is available with patented 1DMax+ with Hotbars, class leading 2-D PowerGrid algorithm, robust plastics, easy setup, and communication.

The DataMan 8700 readers use Cognex's three unique styles of lighting technology and 2DMax+ algorithms to read the most challenging Direct Part Mark barcodes. Tri-Lucent Lighting provides flexible lighting control to create polarized, bright field, and diffuse lighting.

The DataMan 8700 readers are available with the following communication options:

- Ethernet, with industrial protocols
- USB
- RS-232
- Bluetooth

An intelligent base station is provided when the DataMan 8700 reader uses Bluetooth connection. The base station acts as a router between the reader and your computer, PLC, or network.



Note: The term 'wireless' refers to the Wi-Fi or to the Bluetooth communication module of the reader.

The DataMan 8700 series base stations are available with the following communication options:

	Base Station Communication			Wireless Protocol
	Ethernet with Industrial Protocols	USB	RS-232	Bluetooth
DMB-8700-xxx	√	√	√	√

DataMan 8700 Accessories

Miscellaneous Accessories







Accessory Name	Accessory Number	Accessory Image
DM8700 slide-in communication conversion kits	DM8700-USB-Kit DM8700-RS-Kit DM8700-ENET-Kit	
Power Supply for reader and base station	DM8700-PWR-00	
Intelligent Bluetooth Base Station	DMB-8700-xxx ¹	
4500 mAh Battery for the wireless Reader	DMA-BATTERY-5000	
POE Adapter	CPS-24V-POE1	
POE Adapter	CPS-24V-POE4	
POE Adapter	CPS-AC-POE1A-xx ²	
Wall Mount Bracket	DMA-WALL-8700	
Presentation Stand, can be used with wall mount bracket (DMA-WALL-8700)	DM-STAND-00	
Holster	DMA-HOLSTER-8700	

¹ xxx changes depending on the communication: -USB (USB) , -RS (RS-232), -E (Ethernet).

² xx can be US, EN, UK, or JP.

Cables

Note: Cables are sold separately.

Accessory Name	Accessory Number	Accessory Image
RS-232 coiled cable for Reader with Dsub-9 connector, power over pin 9, 2.5 m	DMC-HH-RS232P-02C	
RS-232 coiled cable for Reader with Dsub9 connector, 2.5 m	DMC-HH-RS232-02C	
RS-232 coiled cable for Reader with Dsub9 connector, 4 m	DMC-HH-RS232-05C	
RS-232 Firmware update cable, RS-232 to USB converter	DMC-HH-RS232-USB	
USB straight cable with type A connector, 2.5 m	DMC-HH-USBA-02	
USB straight cable with type C connector, 2.5 m	DMC-HH-USBC-02	
USB coiled cable with type A connector, 2.5 m	DMC-HH-USBA-02C	
USB cable with type C connector, coiled, 2.5 m	DMC-HH-USBC-02C	
Ethernet coiled cable with RJ45 connector, 5 m	DMC-HH-ENET-05C ¹	
Ethernet straight cable with RJ45 connector, 2.5 m	DMC-HH-ENET-02	
Ethernet straight cable with RJ45 connector, 5 m	DMC-HH-ENET-05	
Ethernet straight cable with RJ45 connector, 30 m	DMC-HH-ENET-30	
Ethernet coiled cable with M12 Xcoded connector, 5 m	DMC-HH-ENETM12-05C	

¹ Collimated cable length including DM8700-ECABLE-X should not exceed 50 m.

Physical Layout of the Reader



DataMan 8700 Reader

1	LED aimer
2	Trigger (press and hold to read)
3	Cable
4	360° ring light indicator
5	Lanyard hook
6	OLED display
7	Buttons for OLED input and configuration
8	Diffused light
9	Polarized light
10	Direct light

OLED Display Layout

The OLED display is user interface where you can communicate with the DataMan 8700.

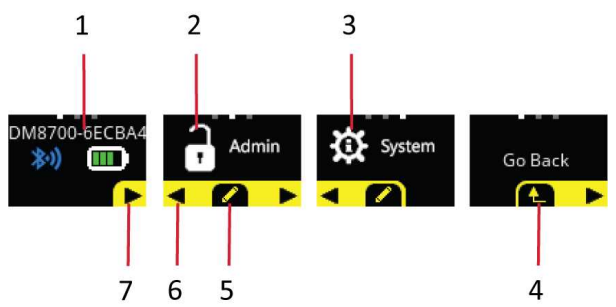

Number	Screen or Icon	Description
1	Main Screen	First screen after boot up is complete. The main screen contains information about the name of the reader, the Bluetooth connection and the battery status of the reader. ¹
2	Admin Screen	Enter the menu on the admin screen, where you can set passwords and other permissions.
3	System Screen	Enter the system menu, where you can configure settings
4	Return arrow	Return 1 level up in the menu
5	Action button	Displays a pencil, a check mark, or a toggle icon to select, acknowledge or change a setting.
6	Left arrow	Move to previous screen.
7	Right arrow	Move to next screen

¹ The Bluetooth connection and the battery status of the reader is only displayed on wireless readers.

Physical Layout of the Base Station

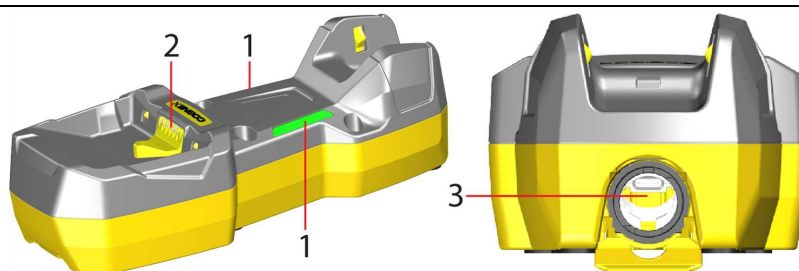

DMB-8700-xxx¹ Base Station

1	<p>Base station status indicators</p> <p>Reader on base station:</p> <ul style="list-style-type: none"> • RED = charging, or indicating contact status with the cradle <p>Reader off base station:</p> <ul style="list-style-type: none"> • BLUE = connected via BT • OFF = no connection
2	<p>Connection point with the reader:</p> <ul style="list-style-type: none"> • Pairing reader and base station (establishing connection after initial discovery) • Communication • Charging
3	<p>Cable plug</p>

¹ xxx changes depending on the communication: -USB (USB) , -RS (RS-232), -E (Ethernet).

Setting up Your DataMan 8700

Setting up the Reader Setting Up the Verifier

To connect to the reader or base station on your computer:

1. Select the connection type: Ethernet, RS-232 Serial, or USB, and connect the cables respectively.

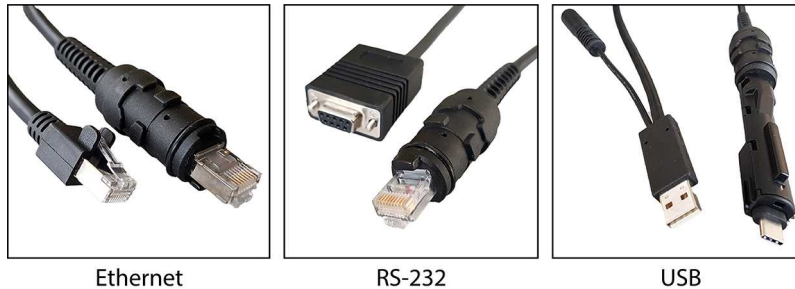

2. Turn on your device(s).

Install the DataMan SetupTool and Connect to Reader

1. Check the DataMan **Release Notes** for a full list of system requirements.
2. Download the DataMan Setup Tool from cognex.com/support/dataman and follow the on-screen steps.
3. Connect the DataMan 8700 to your PC.
4. Launch the DataMan Setup Tool and click **Refresh**. The or the base station appears under **COM ports** or **Network devices**.
5. Select a **COM port** or a **Network device** and click **Connect**.

DataMan 8700 Specifications

Specification	DataMan 8700 Reader
Weight	Wireless: 530 g (18.70 oz) (battery included) Corded: 450 g (15.90 oz) + ~130 g (4.59 oz) cables
Operating Temperature	0 °C — 40 °C (32 °F — 104 °F)
Storage Temperature	-40 °C — 60 °C (-40 °F — 140 °F)
Maximum Humidity	< 95% (non-condensing)
Environmental	Compliant with latest EU RoHS and China RoHS For indoor use only
Symbologies	1-D barcodes: Codabar, Code 39, Code 128, and Code 93, Interleaved 2 of 5, Postal, UPC/JAN, POSTNET, PLANET Code, GS1 IMB 2-D barcodes: MaxiCode, Aztec Code, Data Matrix™; QR Code and microQR Code, PDF 417
Power Supply Requirements	Serial/USB: 5.5 V DC, 6.0 W maximum LPS or NEC Class 2 power supply Ethernet: PoE Class 2 power supply Wireless: 3.6 V, 4500 mAh Li-ion battery

Specification	DataMan 8700 Reader
Battery life for wireless reader (typical use case)	The expected life time of the battery is 5 years. Charging time through PoE: 10-11 hours Charging time through USB with external power: 6.2 hours
Ethernet	10/100 Base-T FULL/HALF DUPLEX, IEEE 802.3
Bluetooth	Bluetooth 4.2, Classic, 2.4~2.4835 GHz
Protection	ISO 16750-5 IP67 Endures multiple drops from 2.5 m height on concrete

DataMan 8700 Imager Specifications

Specifications	DataMan 8700 Imager
Image Sensor	1/3 inch CMOS
Image Sensor Properties	3.45 μm square pixels
Image Resolution	1440 x 1080 pixels

DataMan DataMan 8700 Base Station Specifications

Specification	DMB-8700-xx (depending on the communication type)
Weight	500 g (17.63 oz)
Operating Temperature	0 °C — 40 °C (32 °F — 113 °F)
Storage Temperature	-40 °C — 60 °C (-40 °F — 140 °F)
Maximum Humidity	95% (non-condensing)
Power Supply Requirements	5.5 V DC, 6 W maximum LPS or NEC Class 2 power supply or PoE Class 2 power supply
Protection	IP65
Ethernet	10/100 Base-T FULL/HALF DUPLEX, IEEE 802.3
Bluetooth	Bluetooth 4.2, Classic, 2.4~2.4835 GHz

LED Wavelengths for DataMan 8700 DX Reader

Note: The data below refer to the LED illumination accessory of the reader, not to the LED indicators.

The following table shows LED types and the related wavelengths:

LED	λ [nm]
RED	660

Connection Options

Connecting Corded DataMan 8700

1. Connect the serial slide-in to your DataMan 8700. See the list of serial slide-ins in [Miscellaneous Accessories on page 8](#)

Note: Disconnect the DataMan 8700 from power before inserting or removing the communication modules.

2. Insert the plug, slide the cable lock up to the reader and twist the cable lock in place. See available cables in chapter [Cables on page 9](#).

Note: USB and RS-232 devices need external power.

Note: Cables are sold separately.

Troubleshooting an Ethernet Connection

If your reader does not appear in the DataMan Setup Tool's list of detected network devices, adjust your network settings.

1. Check your Ethernet connection and click **Refresh** in the DataMan Setup Tool.
2. Scan the **Enable DHCP** code (which you can find in the *DataMan Reader Configuration Codes* document available from the Windows **Start** menu or the Setup Tool **Help** menu). This allows the reader to acquire a suitable IP address from a DHCP server on your subnet.

If the reader still does not appear, you can use the **Add Device** option in the DataMan Setup Tool.

If you know the IP address of the reader, use the **Add Network Device** option under **Repair & Support**. This method allows the DataMan 8700 reader to appear in the list of **Network devices** so that you can connect to it through the DataMan Setup Tool and your Ethernet connection.

Using Your Device Through USB

To use the device in USB 2.0 mode, connect the base station either with a coiled or a straight USB cable to the host.

Set the **USB Connection** properties in the **Serial** tab of the **Communication Settings** pane in DataMan Setup Tool.

DM8700, as a composite USB device, implements the following USB device classes:

- Virtual serial mode (CDC ACM): the host OS recognizes the virtual port as a serial port. DataMan Setup Tool, terminal emulators, and custom applications (e.g. applications developed using the DataMan SDK) work in virtual serial mode.

- HID keyboard: the device functions as an emulated keyboard.

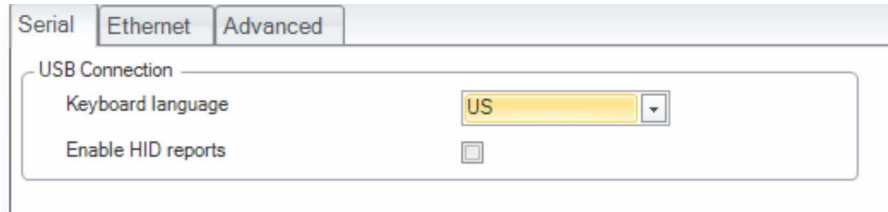

Set the language of the keyboard. HID reports use the keyboard language set in the drop down menu.

To enable HID reports, tick the checkbox in DataMan Setup Tool. When enabled, HID reports are sent to the host. Communication through HID reports is similar to using a physical keyboard.

Note: Using keyboard emulation with applications supporting hotkeys result in unexpected behavior depending on the data of the read codes.

To switch the wireless reader and the base station to USB mode (CDC ACM or HID) with reader configuration codes, scan the appropriate codes from the **DataMan Configuration Codes** document.



1. Open the target window. Make sure that the target window is the active window.
2. Start scanning codes with the corded reader.

In the case of a wireless device:

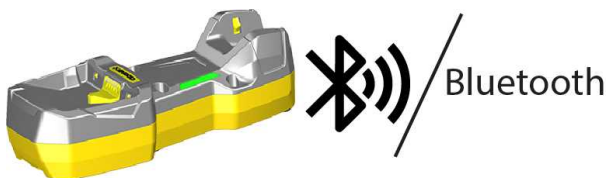

1. Disconnect from the DataMan Setup Tool, if connected.
2. Scan the “**Enable USB Keyboard for the base station**” code from the **DataMan Configuration Codes** document.
3. Start scanning codes with the wireless reader.

Changing Communication in DataMan 8700 Corded Reader

The communication modularity of the DataMan 8700 reader allows using USB, Ethernet and RS-232 slide-in communication type conversion kits. Follow the steps to change the communication conversion kit:

1. Remove the four screws located on the end cap assembly at the base of the reader using a Hex 2.0 mm screwdriver.

Note: Save the screws for later use.



2. Push in the locking pin with the tip of a screwdriver, or with a similar pointy instrument, then twist the end cap.



3. Pull out the end cap assembly with the internal communication slide-in.

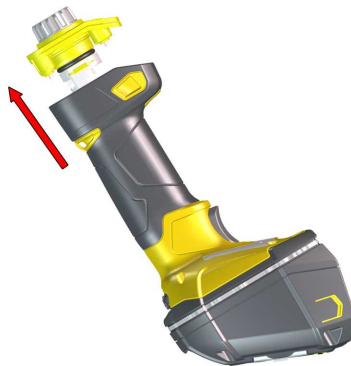

4. Separate the internal slide-in from the end cap assembly.

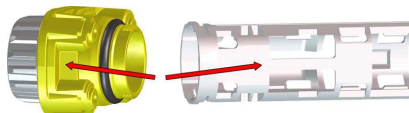

5. Line up the new communication slide-in with the rails on the internal sides of the reader.



6. Insert Internal communication slide-in.



7. Replace the end cap assembly.



8. Insert the screws into the end cap assembly using a Hex 2.0 mm screwdriver.

i Note: Use 0.6 Nm (5.31 in-lb) torque on the screws and tighten in the sequence shown in the image.

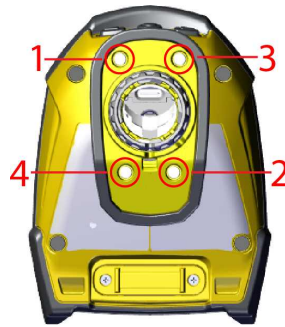

Using DataMan 8700 Wireless Reader

This section provides wireless reader specific procedures.

Connecting to a Wireless DataMan 8700 Through Base Station

1. Open end cap and insert the battery. Make sure you insert the battery into the slot with the metal contact pins pushed in first.

 **Tip:** A small triangle on one side of the battery is also indicating the correct placement.

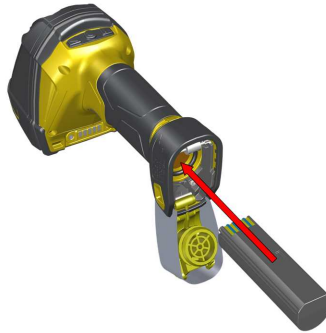

2. Press the metal tab until you hear a click to close the end cap.



3. Connect the USB or RS-232 cable with external power or the Power over Ethernet (PoE) cable to the base station.

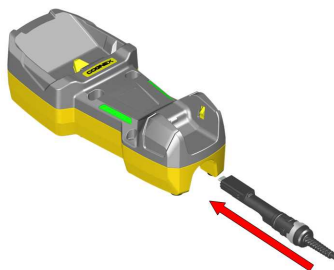

4. Connect the other end of the cable to the computer or to the hub.

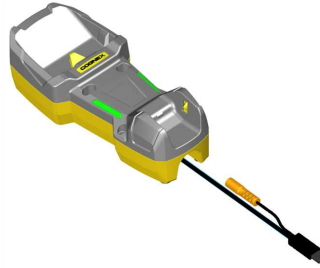

5. If using PoE cable, skip this step. For cables with RS-232 or USB-A connector, connect the 5.5 V power supply.



Pairing Wireless Readers to Base Station

Pairing Wireless Readers to Base Station Through Bluetooth

1. Place the reader in the base station.
2. A dialog appears on the OLED display of the reader asking if you want to pair the reader with the base station.
3. Confirm assignment by using the buttons under the OLED display.

Note: A new reader and a new base station pair each other automatically.

4. Lift your reader up from the base station and start reading codes.

Note:

- When the reader is on the base station, communication is established by means of cradle contacts. When the reader is in the cradle, the wireless communication is still enabled.
- Configure wireless communication settings by connecting to the base station. In order for the changed settings to be synchronized between the DataMan 8700 wireless reader and the base station, place your reader in the base station after your changes are saved. To assign a static IP address to the base station when communicating via Ethernet, connect to the base station in the DataMan Setup Tool. The base station, however, auto-assigns the IP address¹ to the reader when they become paired.
- When you connect with the base station to a terminal program, your wireless reader sends decode results to the terminal.
- DMCC commands are sent to the reader through the base station.



Base Station Connection Options

The following table shows the connection options of the base station according to communication type:

Base Station Connection Type	How to Connect
RS-232	Connect to the cable plug of the base station.

¹ Do not use the networks 192.168.37.0/24 and 192.168.148.0/24 for base stations.

Base Station Connection Type	How to Connect
USB	Connect to the cable plug of the base station.
Ethernet	Connect to the terminal program using the IP address of the reader. To find out the IP address, go to the Connect backstage page in the DataMan Setup Tool and check the IP address of the reader in the Address column.

Base Station Routing Capabilities

The base station is visible as connected through either RS-232, USB, or Ethernet.

The base station transfers data to the reader:

- through the wireless interface, or
- through the cradle USB, when the reader is placed on the base station.

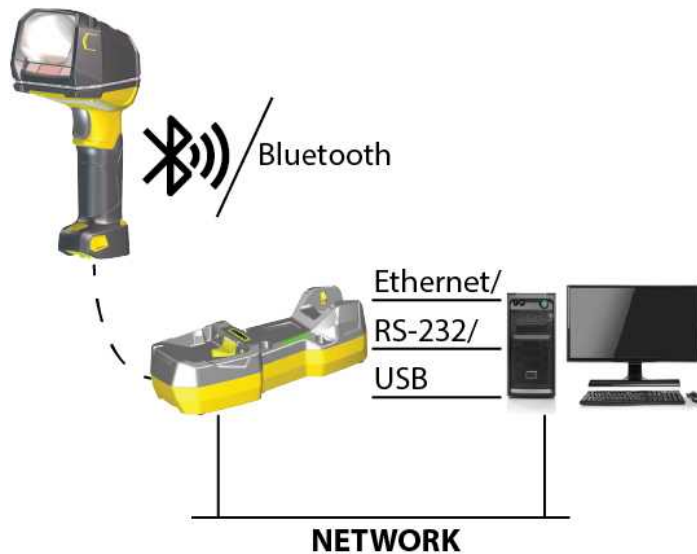

Buffering Data

When you are within the wireless range of the base station, your wireless reader sends decoded data to your host through the base station, just as if you used a corded reader. You can also see the decoded images in the DataMan Setup Tool, if it is running and is connected to the reader.

When you leave the wireless range, you will lose connection to your PC, but you can still keep reading codes. The decoded data is saved in the buffer of the reader.

Note: The images acquired by the reader when it is out of the wireless range are never saved, and cannot be retrieved.

If you were connected to a terminal program when you left the wireless range, the buffered data appears on your PC again when you come back within the wireless range.

Buffered read results on the reader are not displayed in the DataMan Setup Tool; they are only transmitted over an existing keyboard emulation, RS-232 Serial or TCP/IP Telnet connection.

Open a connection with the reader in a terminal program so that you gain the buffered data when wireless connection is re-established.

While you are still within the wireless range, the reader periodically blinks BLUE to indicate that the wireless connection is established.

When the reader leaves the wireless range, the signal of the base station turns off.



Blinking BLUE status indicator: wireless connection is alive.



When you leave the wireless range, a long beep and a single MAGENTA flash on the indicator signals that the reader is going offline. Lack of BLUE blinking on the status indicator: your reader is offline.



When the reader is offline, good reads are indicated with 2 short beeps and the selected good read status indicator color (GREEN by default). The status indicator beeps twice: your reader is offline while decoding symbols.



When the buffer is full, no more codes are read. The reader does not discard the oldest read, the reader beeps and the status indicator changes to WHITE.



Summary of Wireless Buffering Indicators

Condition	Status Indicator: Reader	Status Indicator: Base Station	Sounds
Reader connected to base station	<p>When the reader is awake, blinking BLUE indicates wireless connection with the base.</p> <p>When the reader is offline, there is no indicator.</p> <p>Pull the trigger to wake it up and it will blink BLUE.</p> <p>Good read: GREEN</p> <p>No read: RED</p>	<p>Reader out of the base station and awake: steady BLUE.</p> <p>Reader out of the base station and offline: LED off.</p> <p>Reader in the base station charging: RED.</p> <p>Reader in the base station when charged: RED.</p>	<p>Good read: 1 beep (default)</p> <p>No read: no beep (default)</p>
Reader out of wireless range or not connected to base station	<p>Offline: When the reader wakes up out of the wireless range, there is no indicator.</p> <p>Good read: GREEN (default)</p> <p>No read: RED (default)</p>	<p>Reader offline: LED off.</p>	<p>Long beep when you leave the wireless range.</p> <p>Good read: 2 beeps</p> <p>No read: no beep</p>
Reader not connected to base station, buffer is full	<p>Good read: GREEN and then white.</p> <p>No read: RED (default)</p>	<p>Reader offline: steady RED.</p> <p>Reader offline: LED off.</p>	<p>Good read: long beep</p> <p>No read: no beep</p>

Charging

When you are reading codes with your wireless reader, blinking red status indicators and a warning on the OLED display signal a low battery. As the battery discharges, the blink frequency increases. A blinking red status indicator indicates low battery or thermal shutdown mode.



You can also check the battery status icon on the OLED display .

Place the reader on the base station for charging. Make sure that the pins at the end of the handle make contact with the pins in the base station.

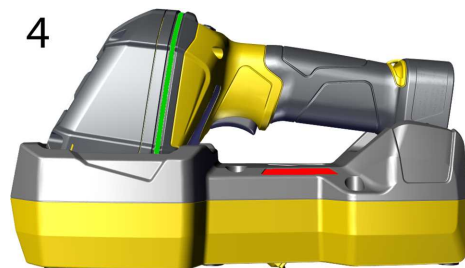
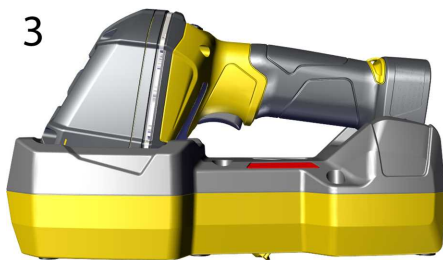
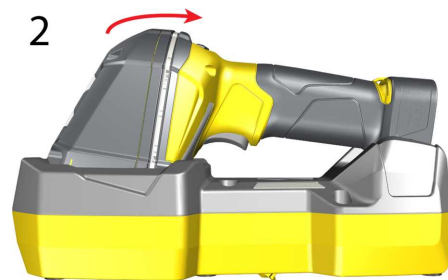

Reader Charging

Reader Fully Charged

Summary of indicator charging signals:

Condition	Status Indicator: Reader ¹	Status Indicator: Base Station
Battery low	flashing RED indicators	steady BLUE, indicating connection
Reader is charging in the base station	indicator is off until fully charged	steady RED, indicating battery charging

¹ Every time the reader is connected to the base station, the blue blinking indicating connection with the base station shows up on the reader.

Condition	Status Indicator: Reader ¹	Status Indicator: Base Station
Reader is fully charged in the base station	steady GREEN indicators	steady RED, indicating contact status with the cradle

Changing Batteries

To change batteries, perform the following steps:

1. Twist the reader's end cap, and take it off. Lift the metal tab and open the end cap of the reader.



2. Hold the reader in an upright position and the battery slides out of the handle.

i Note: You may need to shake the reader slightly.



⚠ WARNING: The battery used in these devices may present a risk of fire or chemical burn if mistreated. Do not disassemble, heat above 60 °C (140 °F), or incinerate. Replace battery with Cognex DMA-BATTERY-5000 only. Any other battery may present a risk of fire or explosion.

¹ Every time the reader is connected to the base station, the blue blinking indicating connection with the base station shows up on the reader.

- Put the replacement battery into the slot with the metal contact pins pushed in first.

 **Tip:** A small triangle on one side of the battery is also indicating the correct placement.



- Press the metal tab until you hear a click to close the end cap.



 **WARNING:** Dispose of the used battery promptly. Keep it away from children. Do not disassemble and do not burn it. Use the appropriate separate take-back systems for battery disposal.

Reading Codes with the DataMan 8700

Industrial Protocols

The DataMan 8700 readers support the following industrial protocols:

- EtherNet/IP™
- PROFINET

Select the industrial protocol tools and sample programs when installing the DataMan Setup Tool.

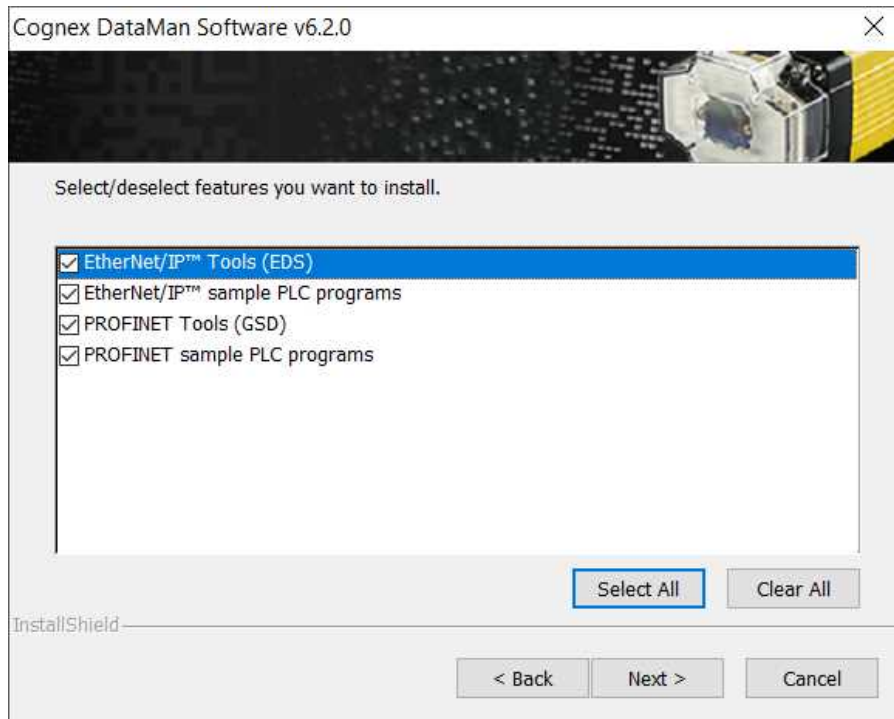

There are three ways to enable or disable Industrial Protocols. Using either method, rebooting the reader is required for the changes to take effect.

- Enable the protocols using the **Industrial Protocols** pane of the DataMan Setup Tool under **Communication Settings**.
- Scan the appropriate **Reader Configuration codes** (see the **Reader Configuration Codes Manual** available through the Windows **Start** menu, the Setup Tool **Help** menu, or the [Cognex Documentation Portal](#)).
- Send the appropriate **DMCC** (see the **DataMan Control Commands Documentation** available through the Windows **Start** menu or the Setup Tool **Help** menu).

For more information on using the industrial protocols, see the **Industrial Protocols Manual** available through the Windows **Start** menu, the Setup Tool **Help** menu, or the [Cognex Documentation Portal](#).

Trigger Types

The DataMan 8700 trigger mode determines when the reader attempts to read a code. Use the DataMan Setup Tool or the appropriate reader configuration codes to change trigger types.

Supported trigger types:

- Manual (default): Pressing the trigger button on the reader starts image acquisition. The reader continues to acquire images until there is a detectable and decoded image or until the release of the trigger button.
- Presentation: When motion is detected in front of the reader, the reader turns on and scans for a symbol. When no motion is detected, the LED aimer and the lights turn off. The reader relies on an internal timing mechanism to acquire images.

Field of View and Reading Distances

The following map shows the range of reading distances available for different code sizes and focus positions.

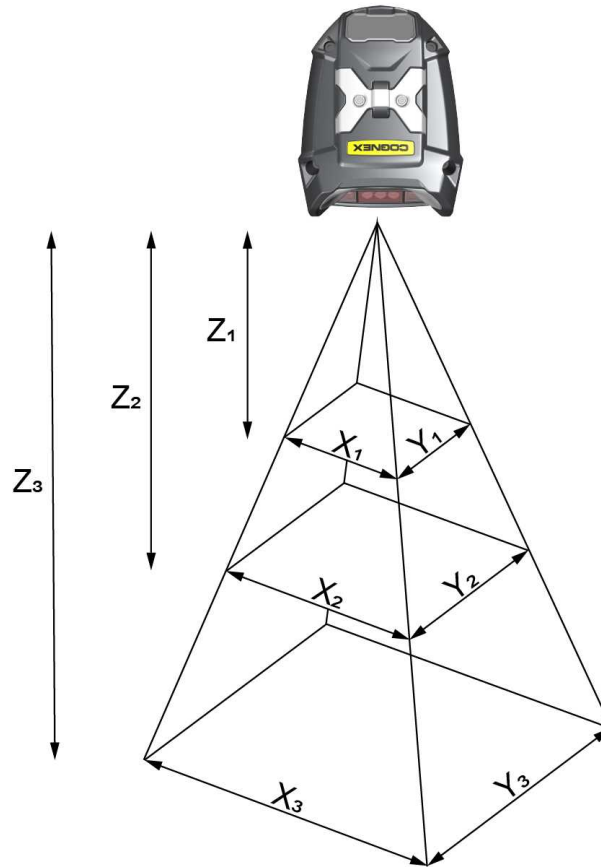

Working Distance	Horizontal Values	Vertical Values
$Z_1 = 40 \text{ mm (1.57 in)}$	$X_1 = 63 \text{ mm (2.5 in)}$	$Y_1 = 47 \text{ mm (1.8 in)}$
$Z_2 = 140 \text{ mm (5.5 in)}$	$X_2 = 126 \text{ mm (5 in)}$	$Y_2 = 95 \text{ mm (3.7 in)}$
$Z_3 = 300 \text{ mm (11.8 in)}$	$X_3 = 288 \text{ mm (11.3 in)}$	$Y_3 = 171 \text{ mm (6.7 in)}$

Distances in mm / 1D min code		Distances in mm / 2D min code	
18-58	3 MIL	10-71	5 MIL
10-175	10 MIL	10-155	10 MIL
0-650	50 MIL	0-650	50 MIL
0-1000	100 MIL	0-1000	100 MIL

i **Note:** All values beginning with 0 denote the minimum distance where the Field of View is able to see the entire code.

i **Note:** The calibration distance is 143.0 mm from the nose of the lens, and the calibration tolerance is +/- 5 mm.

Cleaning and Maintenance

Cleaning the Reader Housing

To clean the outside of the reader housing, use a small amount of mild detergent cleaner or isopropyl alcohol on a cleaning cloth. Do not pour the cleaner on the reader housing.

 **CAUTION:** Do not attempt to clean any DataMan product with harsh or corrosive solvents, including lye, methyl ethyl ketone (MEK) or gasoline.

Cleaning the Reader Lens Cover

To remove dust from the lens cover, use a pressurized air duster. The air must be free of oil, moisture or other contaminants that could remain on the lens cover. To clean the plastic window of the lens cover, use a small amount of isopropyl alcohol on a cleaning cloth. Do not scratch the plastic window. Do not pour the alcohol on the plastic window.

Compliance Information, Warnings and Notices

Regulations and Conformity

The corded DataMan 8700 DX and DQ have Regulatory Models R00083 and R00084, respectively. The wireless DataMan 8700 DX and DQ have Regulatory Models R00085 and R00086, respectively and meet or exceed the requirements of all applicable standards organizations for safe operation. However, as with any electrical equipment, the best way to ensure safe operation is to operate them according to the agency guidelines that follow. Please read these guidelines carefully before using your device.

Note: For the most current CE declaration and regulatory conformity information, see the Cognex support site: cognex.com/support.

The following specifications apply to the corded DataMan 8700 DX and DQ readers:

Regulator	Specification
USA	FCC Part 15B, Class A
Canada	ICES-003
European Community	EN 61010-1 EN 61326-1

The following table shows Safety and Regulatory Information for corded readers:

Safety and Regulatory	
Manufacturer	Cognex Corporation One Vision Drive Natick, MA 01760 USA
CE	Corded DataMan 8700 DX: Regulatory Model R00083 Corded DataMan 8700 DQ: Regulatory Model R00084 This is a Class B product. In a domestic environment this product may cause radio interference in which case the user may be required to take immediate measures. This equipment complies with the essential requirements of the EU Directive 2014/30/EU. Declarations are available from your local representative.
EU RoHS	Compliant to the most recent applicable directive.
FCC	FCC Part 15, Class A This equipment has been tested and found to comply with the limits for a Class A digital device, pursuant to part 15 of the FCC Rules. These limits are designed to provide reasonable protection against harmful interference when the equipment is operated in a commercial environment. This equipment generates, uses, and can radiate radio frequency energy and, if not installed and used in accordance with the instruction manual, may cause harmful interference to radio communications. Operation of this equipment in a residential area is likely to cause harmful interference in which case the user will be required to correct the interference at his own expense.
Canadian Compliance	This Class A digital apparatus complies with Canadian ICES-003. Cet appareil numérique de la classe A est conforme à la norme NMB-003 du Canada.
TÜV	Corded DataMan 8700 DX: Regulatory Model R00083 Corded DataMan 8700 DQ: Regulatory Model R00084 NRTL: TÜV SÜD SCC/NRTL OSHA Scheme for UL/CAN 61010-1. CB report available upon request. TÜV SÜD, IEC/EN 61010-1.

The following specifications apply to the DataMan 8700 DX and DQ wireless readers:

Regulator	Specification
USA	FCC Part 15B, Class B FCC Part 15C contains FCC ID: TXH-50164
Canada	ICES-003 RSS 247 contains IC: 6315A-50164
European Community	For Bluetooth EN61010-1 EN ETSI 301 489-1/-17 EN ETSI 300 328

The following table shows Safety and Regulatory Information for wireless readers:

Safety and Regulatory	
Manufacturer	Cognex Corporation One Vision Drive Natick, MA 01760 USA
	Wireless DataMan 8700 DX: Regulatory Model R00085 Wireless DataMan 8700 DQ: Regulatory Model R00086 This is a Class B product. In a domestic environment this product may cause radio interference in which case the user may be required to take immediate measures. This equipment complies with the essential requirements of the EU Directive 2014/53/EU. Declarations are available from your local representative.
EU RoHS	Compliant to the most recent applicable directive.
FCC	FCC Part 15 This device complies with part 15 of the FCC Rules and Industry Canada license-exempt RSS standard(s). Operation is subject to the following two conditions: (1) This device may not cause harmful interference, and (2) this device must accept any interference received, including interference that may cause undesired operation. Changes or modifications not expressly approved by the party responsible for compliance could void the user's authority to operate the equipment.
Canadian Compliance	This device complies with part 15 of the FCC Rules and Industry Canada license-exempt RSS standard(s). Operation is subject to the following two conditions: (1) This device may not cause harmful interference, and (2) this device must accept any interference received, including interference that may cause undesired operation. Le présent appareil est conforme aux Innovation, Science and Economic Development Canada applicables aux appareils radio exempts de licence. L'exploitation est autorisée aux deux conditions suivantes: (1) l'appareil ne doit pas produire de brouillage, et (2) l'utilisateur de l'appareil doit accepter tout brouillage radioélectrique subi, même si le brouillage est susceptible d'en compromettre le fonctionnement.
TÜV	Wireless DataMan 8700 DX: Regulatory Model R00085 Wireless DataMan 8700 DQ: Regulatory Model R00086 NRTL: TÜV SÜD SCC/NRTL OSHA Scheme for UL/CAN 61010-1. CB report available upon request.TÜV SÜD, IEC/EN 61010-1.

Compliance Statements: DataMan Base Station

The DMB-8700-XXX DataMan Base Stations have the Regulatory model R00087 and meet or exceed the requirements of all applicable standards organizations for safe operation. However, as with any electrical equipment, the best way to ensure safe operation is to operate them according to the agency guidelines that follow.

Note: For the most current CE declaration and regulatory conformity information, see the Cognex support site: cognex.com/support.

Please read these guidelines carefully before using your device.

Regulator	Specification
USA	FCC Part 15B, Class B FCC Part 15C contains FCC ID: TXH-50164
Canada	ICES-003 RSS 247 contains IC: 6315A-50164
European Community	For Bluetooth EN61010-1 EN ETSI 301 489-1/-17 EN ETSI 300 328

Safety and Regulatory	
Manufacturer	Cognex Corporation One Vision Drive Natick, MA 01760 USA
	DMB-8700-XXX DataMan Base Station: Regulatory Model R00087 This is a Class B product. In a domestic environment this product may cause radio interference in which case the user may be required to take immediate measures. This equipment complies with the essential requirements of EU Directive 2014/53/EU. Declarations are available from your local representative.
EU RoHS	Compliant to the most recent applicable directive.
FCC	FCC Part 15 This device complies with part 15 of the FCC Rules and Industry Canada license-exempt RSS standard(s). Operation is subject to the following two conditions: (1) This device may not cause harmful interference, and (2) this device must accept any interference received, including interference that may cause undesired operation. Changes or modifications not expressly approved by the party responsible for compliance could void the user's authority to operate the equipment.

Safety and Regulatory	
Canadian Compliance	<p>This device complies with part 15 of the FCC Rules and Industry Canada license-exempt RSS standard(s). Operation is subject to the following two conditions:</p> <p>(1) This device may not cause harmful interference, and</p> <p>(2) this device must accept any interference received, including interference that may cause undesired operation.</p> <p>Le présent appareil est conforme aux Innovation, Science and Economic Development Canada applicables aux appareils radio exempts de licence. L'exploitation est autorisée aux deux conditions suivantes:</p> <p>(1) l'appareil ne doit pas produire de brouillage, et</p> <p>(2) l'utilisateur de l'appareil doit accepter tout brouillage radioélectrique subi, même si le brouillage est susceptible d'en compromettre le fonctionnement.</p>
TÜV	<p>DataMan 8700 Base Station Regulatory Model R00087</p> <p>NRTL: TÜV SÜD SCC/NRTL OSHA Scheme for UL/CAN 61010-1.</p> <p>CB report available upon request.TÜV SÜD, IEC/EN 61010-1.</p>

For European Community Users

Cognex complies with Directive 2012/19/EU OF THE EUROPEAN PARLIAMENT AND OF THE COUNCIL of 4 July 2012 on waste electrical and electronic equipment (WEEE).

This product has required the extraction and use of natural resources for its production. It may contain hazardous substances that could impact health and the environment, if not properly disposed.

In order to avoid the dissemination of those substances in our environment and to diminish the pressure on the natural resources, we encourage you to use the appropriate take-back systems for product disposal. Those systems will reuse or recycle most of the materials of the product you are disposing in a sound way.



The crossed out wheeled bin symbol informs you that the product should not be disposed of along with municipal waste and invites you to use the appropriate separate take-back systems for product disposal.

If you need more information on the collection, reuse, and recycling systems, please contact your local or regional waste administration.

You may also contact your supplier for more information on the environmental performance of this product.

中国大陆RoHS (Information for China RoHS Compliance)

根据中国大陆《电子信息产品污染控制管理办法》(也称为中国大陆RoHS), 以下部份列出了本产品中可能包含的有毒有害物质或元素的名称和含量。



Table of toxic and hazardous substances/elements and their content, as required by China's management methods for controlling pollution by electronic information products.

	Hazardous Substances 有害物质
--	---------------------------

Part Name 部件名称	Lead (Pb) 铅	Mercury (Hg) 汞	Cadmium (Cd) 镉	Hexavalent Chromium (Cr (VI)) 六价铬	Polybrominated biphenyls (PBB) 多溴联苯	Polybrominated diphenyl ethers (PBDE) 多溴二苯醚
Regulatory Model R00083 Regulatory Model R00085 Regulatory Model R00087	X	O	O	O	O	O

This table is prepared in accordance with the provisions of SJ/T 11364.

这个标签是根据SJ/T 11364 的规定准备的。

O: Indicates that said hazardous substance contained in all of the homogeneous materials for this part is below the limit requirement of GB / T26572 - 2011.

表示本部件所有均质材料中含有的有害物质低于GB / T26572 - 2011 的限量要求。

X: Indicates that said hazardous substance contained in at least one of the homogeneous materials used for this part is above the limit requirement of GB / T26572 - 2011.

表示用于本部件的至少一种均质材料中所含的危害物质超过GB / T26572 - 2011 的限制要求。

