

DataMan[®] 370 Series Reference Manual



2021 September 28
Revision: 6.1.10-SR3.11

Legal Notices

The software described in this document is furnished under license, and may be used or copied only in accordance with the terms of such license and with the inclusion of the copyright notice shown on this page. Neither the software, this document, nor any copies thereof may be provided to, or otherwise made available to, anyone other than the licensee. Title to, and ownership of, this software remains with Cognex Corporation or its licensor. Cognex Corporation assumes no responsibility for the use or reliability of its software on equipment that is not supplied by Cognex Corporation. Cognex Corporation makes no warranties, either express or implied, regarding the described software, its merchantability, non-infringement or its fitness for any particular purpose.

The information in this document is subject to change without notice and should not be construed as a commitment by Cognex Corporation. Cognex Corporation is not responsible for any errors that may be present in either this document or the associated software.

Companies, names, and data used in examples herein are fictitious unless otherwise noted. No part of this document may be reproduced or transmitted in any form or by any means, electronic or mechanical, for any purpose, nor transferred to any other media or language without the written permission of Cognex Corporation.

Copyright © 2021. Cognex Corporation. All Rights Reserved.

Portions of the hardware and software provided by Cognex may be covered by one or more U.S. and foreign patents, as well as pending U.S. and foreign patents listed on the Cognex web site at: cognex.com/patents.

The following are registered trademarks of Cognex Corporation:

Cognex, 2DMAX, Advantage, AlignPlus, Assemblyplus, Check it with Checker, Checker, Cognex Vision for Industry, Cognex VSOC, CVL, DataMan, DisplayInspect, DVT, EasyBuilder, Hotbars, IDMax, In-Sight, Laser Killer, MVS-8000, OmniView, PatFind, PatFlex, PatInspect, PatMax, PatQuick, SensorView, SmartView, SmartAdvisor, SmartLearn, UltraLight, Vision Solutions, VisionPro, VisionView

The following are trademarks of Cognex Corporation:

The Cognex logo, 1DMax, 3D-Locate, 3DMax, BGAll, CheckPoint, Cognex VSoC, CVC-1000, FFD, iLearn, In-Sight (design insignia with cross-hairs), In-Sight 2000, InspectEdge, Inspection Designer, MVS, NotchMax, OCRMax, PatMax RedLine, ProofRead, SmartSync, ProfilePlus, SmartDisplay, SmartSystem, SMD4, VisiFlex, Xpand

Portions copyright © Microsoft Corporation. All rights reserved.

Portions copyright © MadCap Software, Inc. All rights reserved.

Other product and company trademarks identified herein are the trademarks of their respective owners.

Table of Contents

Legal Notices	2
Table of Contents	3
Symbols	5
Getting Started	6
About the DataMan 370 Reader	6
Supporting Documentation	6
DataMan 370 Series Accessories	7
Lens Options	7
Lens Covers and Internal Illumination	8
High Power Illumination Accessories	9
High Power Integrated Torch Accessories	10
External Lights	11
Field of View Expanders	12
Cables and Power Supply	12
Mounting Brackets	14
DataMan 370 Systems	15
Setting Up Your DataMan 370 Reader	17
Reader Layout	17
Dimensions	19
DataMan 370	19
DataMan 370 with High Power Integrated Light (HPIL)	19
DataMan 370 with High Power Illumination Accessory (HPIA)	20
DataMan 370 Series with High Power Integrated Torch (HPIT)	20
DataMan 370 Series with High Power Integrated Torch (HPIT) and Passive Diffuser	21
Assembling DataMan 370 Series Lens and Lights	21
Installing the Liquid Lens module with High Power Integrated Light (HPIL)	22
Installing a Lens with High Power Illumination Accessory (HPIA)	26
Installing High Power Integrated Torch (HPIT)	30
Installing a C-Mount Lens	34
Connecting External Illumination to DataMan 370	37
Mounting the Reader	40
Setting Focus	42
Liquid Lens	42
Manual Focus Lens	44
Focus Feedback	44
Best Practices	45
Field of View and Reading Distances	46
Reading Distance and Field of View (DataMan 370 Readers with a 8 mm High-Speed Liquid Lens)	46
Reading Distance and Field of View (DataMan 370 Readers with a 10 mm High-Speed Liquid Lens)	47
Reading Distance and Field of View (DataMan 370 Readers with a 16 mm High-Speed Liquid Lens)	47
Reading Distance and Field of View (DataMan 370 Readers with a 24 mm High-Speed Liquid Lens)	48
Reading Distance and Field of View (DataMan 370 Readers with a 35 mm High-Speed Liquid Lens)	49
Maintenance	50
Replacing the SD Card	50

Additional Information	51
LED and Laser Wavelengths	52
Using Your DataMan 370 Reader	53
Reading your first Code	53
DataMan 370 Triggering	56
External Triggers	57
Training the Reader	58
Training Feedback	58
Incremental Training for Multiple Symbologies	59
Industrial Protocols	60
Advanced Features	60
DataMan 370 Series Image Filtering	61
Package Detection Support	62
DataMan 370 Series Multi-Reader Sync Option	62
Connections, Optics, and Lighting	64
External Light Control (CCB-M12XFLY-05)	64
5 m Breakout Cable (CCBL-05-01)	65
5m Breakout Cable (CCB-M12x12Fy-xx)	66
15m Breakout Cable (CCB-PWRIO-XX)	67
Acquisition Trigger	67
High-Speed Outputs	68
High-Speed Output Wiring	69
Connecting the Encoder to Your DataMan 370 Reader	69
5m RS-232 Connection Cable (CCB-M12XDB9Y-05)	71
Cleaning and Maintenance	73
Cleaning the Reader Housing	73
Cleaning the Reader Lens Cover	73
Compliance Information, Warnings and Notices	74
Precautions	74
Regulations/Conformity	75
For European Community Users	75
Reader Programming Codes	76

Symbols

The following symbols indicate safety precautions and supplemental information:

 **WARNING:** This symbol indicates a hazard that could cause death, serious personal injury or electrical shock.

 **CAUTION:** This symbol indicates a hazard that could result in property damage.

 **Note:** This symbol indicates additional information about a subject.

 **Tip:** This symbol indicates suggestions and shortcuts that might not otherwise be apparent.

Getting Started

This section provides general information about the DataMan 370 series reader and the DataMan 370 accessories and systems.

About the DataMan 370 Reader



The DataMan 370 series readers are high-performance, fixed-mount ID readers that offer:

- Superior read performance with advanced 1D and 2D algorithms with tri-core processing power
- Best in Class Imaging
- Modular Lighting / Lensing with High Dynamic Range (HDR)
- Faster Setup to Installation Experience
- Optimized Ease of Use

The DataMan 370 series readers provide advanced Ethernet connectivity, support for serial RS-232 and discrete I/O, and advanced options for lighting and optics.

The DataMan 370 series readers are packaged in a rugged, IP67-rated housing, and provide numerous ease-of-use features, including one button to trigger and one to start tuning.

Supporting Documentation

This document provides basic information about the DataMan 370 series readers. Additional information is available through the Windows **Start** menu or the DataMan Setup Tool **Help** menu after you install the DataMan software on your PC:

- The ***DataMan Communications and Programming Guide*** shows you how to integrate your DataMan reader into your particular automation and factory environment.

Cognex->DataMan Software v x.x.x->Documentation->Communications->DataMan Communications and Programming Guide

- The ***DataMan Industrial Protocols Manual*** provides information on how to integrate DataMan reader into your particular environment using industrial protocols.



Cognex->DataMan Software v x.x.x->Documentation->Communications->DataMan Industrial Protocols Manual

- The **DataMan Reader Configuration Codes** document provides printable 2-D codes that you can use to configure the DataMan reader.
Cognex->DataMan Software v x.x.x->Documentation->English->Reader Configuration Codes
- The **DM370 Quick Reference Guide** provides essential information about the DM370 reader.
Cognex->DataMan Software v x.x.x->Documentation->English->DM370 Series->DM370 Quick Reference Guide
- The **DataMan Fixed-Mount Readers Reference** is a complete online hardware reference for the DataMan fixed-mount ID reader.
Cognex->DataMan Software v x.x.x->Documentation->English->DM370 ->Fixed-Mount Reference Manual
- The **DataMan Questions and Answers** document provides context-sensitive information. You can view this help inside the DataMan Setup Tool or as a stand-alone help file.
Cognex->DataMan Software v x.x.x->Documentation->DM370->Questions and Answers
- The **DataMan Control Commands** lists DataMan Control Commands with all relevant information. You can view this help inside the Setup Tool or as a stand-alone help file.
Cognex->DataMan Software v x.x.x->Documentation->English->DataMan Control Commands
- The **Setup Tool Reference Manual** describes the user interface of the DataMan Setup Tool software.
Cognex->DataMan Software v x.x.x->Documentation->English->Setup Tool Reference Manual
- The **Release Notes** list detailed system requirements and additional information about this DataMan software release.
Cognex->DataMan Software v x.x.x->Documentation->DataMan v x.x.x Release Notes

DataMan 370 Series Accessories

Lens Options

Accessory		DM374	DM375
8 mm F5.6 fixed aperture lens	LEC-CFF08-F5.6	✓	✓
12 mm F8 fixed aperture lens	LEC-CFF12-F8		
16 mm F8 fixed aperture lens	LEC-CFF16-F8		
25 mm F8 fixed aperture lens	LEC-CFF25-F8		
35 mm F8 fixed aperture lens	LEC-CFF35-F8		
40 mm F8 fixed aperture lens	LEC-CFF40-F8		
50 mm F8 fixed aperture lens	LEC-CFF50-F8		
Liquid lens module and pre-focused 10.3 mm* or 10.3 mm IR** M12 lens with wrench	DMLN-10LL-SMT DMLN-10LL-IR-SMT	✓	



Accessory			DM374	DM375		
24 mm F6 liquid lens module*	DM360-LENS-24LL		✓			
24 mm F6 liquid lens module***	DMLN-C24F06-LL-IR					
24 mm F10 liquid lens module*	DMLN-C24F10-LL					
8 mm F8 autofocus lens* (use with HPIL wide)	DMLN-C8F08-HSLL		✓			
10 mm F5 autofocus lens* (use with HPIT)	DMLN-C10F05-HSLL					
16 mm F8 autofocus lens* (use with HPIT)	DMLN-C16F08-HSLL				✓	✓
24 mm F6 autofocus lens* (use with HPIT)	DMLN-C24F06-HSLL					
35 mm F8 autofocus lens* (use with HPIT)	DMLN-C35F08-HSLL					

* With built-in IR blocking filter

** Without built-in IR blocking filter

*** Without built-in IR blocking filter, and with built-in daylight filter



Lens Covers and Internal Illumination

Accessory			DM374	DM375
C-Mount cover for C-Mount lenses	DM300-CMCOV		✓	✓
Short C-Mount cover for C-Mount lenses	DM300-CMCOV-SH		✓	✓
Extension kit	DM300-EXT		✓	

Accessory		DM374	DM375
Red LED HPIL, ESD safe, 10.3 mm lens (Risk Group Red LED Exempt acc. IEC 62471, Risk Group Green LED Aimer Exempt acc. IEC 62471)	DM360-HPIL-RE		✓
Polarized red LED HPIL, ESD safe, 10.3 mm lens (Risk Group Red LED Exempt acc. IEC 62471, Risk Group Green LED Aimer Exempt acc. IEC 62471)	DM360-HPIL-RE-P		
White LED HPIL, ESD safe, 10.3 mm lens (Risk Group White LED low risk acc. IEC 62471, Risk Group Green LED Aimer Exempt acc. IEC 62471)	DM360-HPIL-WHI		
Red LED HPIL, ESD safe, 24 mm liquid lens (Risk Group Red LED Exempt acc. IEC 62471, Risk Group Green LED Aimer Exempt acc. IEC 62471)	DMLT-HPIL-RE		
Polarized red LED HPIL, ESD safe, 24 mm liquid lens (Risk Group Red LED Exempt acc. IEC 62471, Risk Group Green LED Aimer Exempt acc. IEC 62471)	DMLT-HPIL-RE-P		
White LED HPIL, ESD safe, 24 mm liquid lens (Risk Group White LED low risk acc. IEC 62471, Risk Group Green LED Aimer Exempt acc. IEC 62471)	DMLT-HPIL-WHI		
Infrared LED HPIL, ESD safe, 10.3 & 24 mm liquid lens (Risk Group IR LED Exempt acc. IEC 62471, Risk Group Green LED Aimer Exempt acc. IEC 62471)	DMLT-HPIL-IR-W		

High Power Illumination Accessories

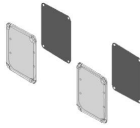

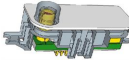
Accessory		DM374	DM375
HPIA, Red narrow (Risk Group White LED low risk acc. IEC 62471)	DM30X-HPIA3-625		✓
HPIA, Red wide (Risk Group White LED low risk acc. IEC 62471)	DM30X-HPIA3-625-W		
HPIA, White narrow (Risk Group White LED low risk acc. IEC 62471)	DM30X-HPIA3-WHI		
HPIA, White wide (Risk Group White LED low risk acc. IEC 62471)	DM30X-HPIA3-WHI-W		
HPIA, Blue narrow (Risk Group White LED low risk acc. IEC 62471)	DM30X-HPIA3-470		
HPIA, Blue wide (Risk Group White LED low risk acc. IEC 62471)	DM30X-HPIA3-470-W		
HPIA, Infrared narrow (Risk Group White LED low risk acc. IEC 62471)	DM30X-HPIA3-IR		
HPIA, Infrared wide (Risk Group White LED low risk acc. IEC 62471)	DM30X-HPIA3-IR-W		



Accessory			DM374	DM375
Linear Polarizer Kit	DM30X-HPIA3-LP		✓	✓
DM500 C-Mount cover (use with HPIA)	DM500-CMTLC-000		✓	✓
DM500 Lens cover extender	DM500-LNSEXT-000		✓	✓
Laser aimer (use with HPIA)	DM300-AIMER-00		✓	✓

WARNING: For DM300-AIMER-00 equipped with laser: This device has been tested in accordance with IEC60825-1 3rd ed., 2014., and has been certified to be under the limits of a Class 2 Laser device.

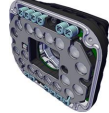

High Power Integrated Torch Accessories

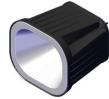
Accessory			DM374	DM375
HPIT, Red wide, 10 and 16 mm high-speed liquid lens (Risk Group Red LED exempt risk acc. IEC 62471)	DMLT-HPIT-RE-W		✓	✓
HPIT, Red standard, 24 mm high-speed liquid lens (Risk Group Red LED exempt risk acc. IEC 62471)	DMLT-HPIT-RE-S			
HPIT, White wide, 10 and 16 mm high-speed liquid lens (Risk Group White LED low risk acc. IEC 62471)	DMLT-HPIT-WHI-W			
HPIT, White standard, 24 mm high-speed liquid lens (Risk Group White LED low risk acc. IEC 62471)	DMLT-HPIT-WHI-S			
HPIT, Red narrow (Risk Group Red LED exempt risk acc. IEC 62471)	DMLT-HPIT-RE-N			
HPIT, White narrow (Risk Group White LED low risk acc. IEC 62471)	DMLT-HPIT-WHI-N			
Fully polarized front cover	DMLA-HPIT-PLCOV-F		✓	✓
Partially polarized front cover	DMLA-HPIT-PLCOV			
Clear front cover	DMLA-HPIT-CLCOV			
Diffuse front cover	DMLA-HPIT-DLCOV			

Accessory			DM374	DM375
Passive Dome front cover	DMLA-HPIT-DFCOV		✓	
Adapter (includes PCB light port adapter)	DMLA-HPIT-ADAP370		✓	

WARNING: For HPIT equipped with a time-of-flight sensor: This device has been tested in accordance with IEC60825-1 3rd ed., 2014., and has been certified to be under the limits of a Class 1 Laser device. Wavelength 930-950 nm invisible laser radiation.







WARNING: For HPIT equipped with a target aimer: This device has been tested in accordance with IEC60825-1 3rd ed., 2014., and has been certified to be under the limits of a Class 2 Laser device. Wavelength 515 nm laser radiation.





External Lights

Accessory			DM374	DM375
Ring Light	CLRR-R7030G1CLR		✓	✓
Back light	CLRB-F100100G1		✓	✓
Coaxial (DOAL) light	CLRO-K5050G1		✓	✓
Spot light	CLRS-P14G1		✓	✓
Dark-field light	CLRD-D120G1		✓	✓

Accessory			DM374	DM375			
Brick light, narrow blue	IVSL-ODDM-S75-470		✓	✓			
Brick light, narrow red	IVSL-ODDM-S75-625						
Brick light, narrow white	IVSL-ODDM-S75-WHI						
Bar light, wide red	IVSL-YLW2X-625		✓	✓			
Bar light, narrow red, linear polarizer	IVSL-YLW2X-625P						
Bar light, narrow infrared	IVSL-YLW2X-850						
Bar light, narrow blue	IVSL-YLW2X-470						
Bar light, wide red	IVSL-YLW2X-625-W						
Bar light, narrow white	IVSL-YLW2X-WHI						
Bar light, wide white	IVSL-YLW2X-WHI-W						
Bar light, wide white, linear polarizer	IVSL-YLW2X-WHIP-W						
Bar light, blue	IVSL-LX520-470					✓	✓
Bar light, red	IVSL-LX520-625						
LX280-series light, blue	IVSL-LX280-470		✓	✓			
LX280-series light, red	IVSL-LX280-625						
Bar light, red	IVSL-LX800-625		✓	✓			









Field of View Expanders

Accessory			DM374	DM375
Field of view expander with mount	DMA-XPAND-100		✓	
Field of view expander	DMA-XPAND-150		✓	
Field of view expander	DMA-XPAND-350		✓	✓



Cables and Power Supply

Note: Cables are sold separately.

CAUTION: All cable connectors are keyed to fit the connectors on the reader. Do not force the connections or damage may occur.

Accessory			DM374	DM375
Connection cable 24V, I/O, RS-232 (y straight/angled, xx specifies length)	CCB-M12x12Fy-xx		✓	✓
Connection cable 24V, I/O, RS-232	CCBL-05-01			
Power and I/O breakout cable, M12-12, straight, xx specifies length: 5 m, 10 m, 15 m, angled, xx specifies length: 5 m, 10 m, 15 m	CCB-PWRIO-xx CCB-PWRIO-xxR			
Connection cable RS-232	CCB-M12xDB9Y-05		✓	✓
Power cable for multiple bar lights (use in combination with IVSL-5PM12-5)	CCB-FOV25-MAL-012		✓	✓
X-Coded to A-Coded Ethernet cable adapter, 0.5 m	CCB-M12X8MS-XCAC			
X-Coded to RJ45 Ethernet cable, xx specifies length: 2 m, 5 m, 15 m, 30 m	CCB-84901-2001-xx		✓	✓
I/O extension cable, straight, 5 m	CKR-200-CBL-EXT		✓	✓
Connection module (up to 4 cameras including network switch) (xx can be US, EU, UK or JP)	DMA-CCM-4X-xx		✓	✓
Connection module (1 camera) (xx can be US, EU, UK or JP)	DMA-CCM-1-xx		✓	✓
External light cable (xxx specifies length) Compatible with CLRR / CLRB / CLRO / CLRS / CLRD illumination	CCB-M12x4MS-xxx		✓	✓
External light control cable for DataMan, 5 meters in length with flying leads	CCB-M12XFLY-05			
Bar light cable (xxx specifies length: 300, 500, 1000, 2000 mm) Compatible with IVSL lights, except IVSL-LX280	IVSL-5PM12-Jxxx			
Power cable for multiple bar lights (use in combination with CCB-FOV25-MAL-012)	IVSL-5PM12-5			
LX280-series light cable	IVSL-FSK-J5000		✓	✓

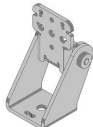
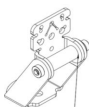
Mounting Brackets

Accessory			DM374	DM375
Flat Mounting Bracket	DMBK-370-MNT		✓	✓
Pivot Mounting Bracket (for factory automation)	DM100-PIVOTM-01		✓	✓
Pivot Mounting Bracket (for logistics)	DMBK-DMPIVOT-00		✓	✓
External Heat Sink	DMHS-370-470		✓	✓
<p>Note: For use with Xpand and over 40° C environments only.</p>				

DataMan 370 Systems

	Omni-directional 1-D Code Reading	1DMax+™ — Best-In- Class 1-D Reading	IDQuick™ — High-Speed 2DMax+™ Reading	2DMax+™ — for hard to read DPM and damaged 2-D PowerGrid™ codes	Multi- Reader Sync	Resolution
DMR-374A-0000-M					✓	2048x1536
DMR-374L-0000		✓				
DMR-374L-0000-M		✓			✓	
DMR-374QL-0000	✓	✓				
DMR-374QL-0000-M	✓	✓			✓	
DMR-374Q-0000	✓	✓	✓			
DMR-374Q-0000-M	✓	✓	✓		✓	
DMR-374X-0000	✓	✓	✓	✓		
DMR-374X-0000-M	✓	✓	✓	✓	✓	

	Omni-directional 1-D Code Reading	1DMax+™ — Best-In-Class 1-D Reading	IDQuick™ — High-Speed 2DMax+™ Reading	2DMax+™ — for hard to read DPM and damaged 2-D PowerGrid™ codes	Multi-Reader Sync	Resolution
DMR-375A-0000-M					✓	2448x2048
DMR-375L-0000		✓				
DMR-375L-0000-M		✓			✓	
DMR-375QL-0000	✓	✓				
DMR-375QL-0000-M	✓	✓			✓	
DMR-375Q-0000	✓	✓	✓			
DMR-375Q-0000-M	✓	✓	✓		✓	
DMR-375X-0000	✓	✓	✓	✓		
DMR-375X-0000-M	✓	✓	✓	✓	✓	

Setting Up Your DataMan 370 Reader

This section provides information on the physical appearance of the DataMan 370 reader. It also details the steps of installing the lenses and filters of the reader, and gives information on the imager.

Reader Layout

The following image shows the built-in lighting system of the DataMan 370 series reader the mounting holes underneath the plastic lighting cover, and the laser safety notice on the bottom of the reader.

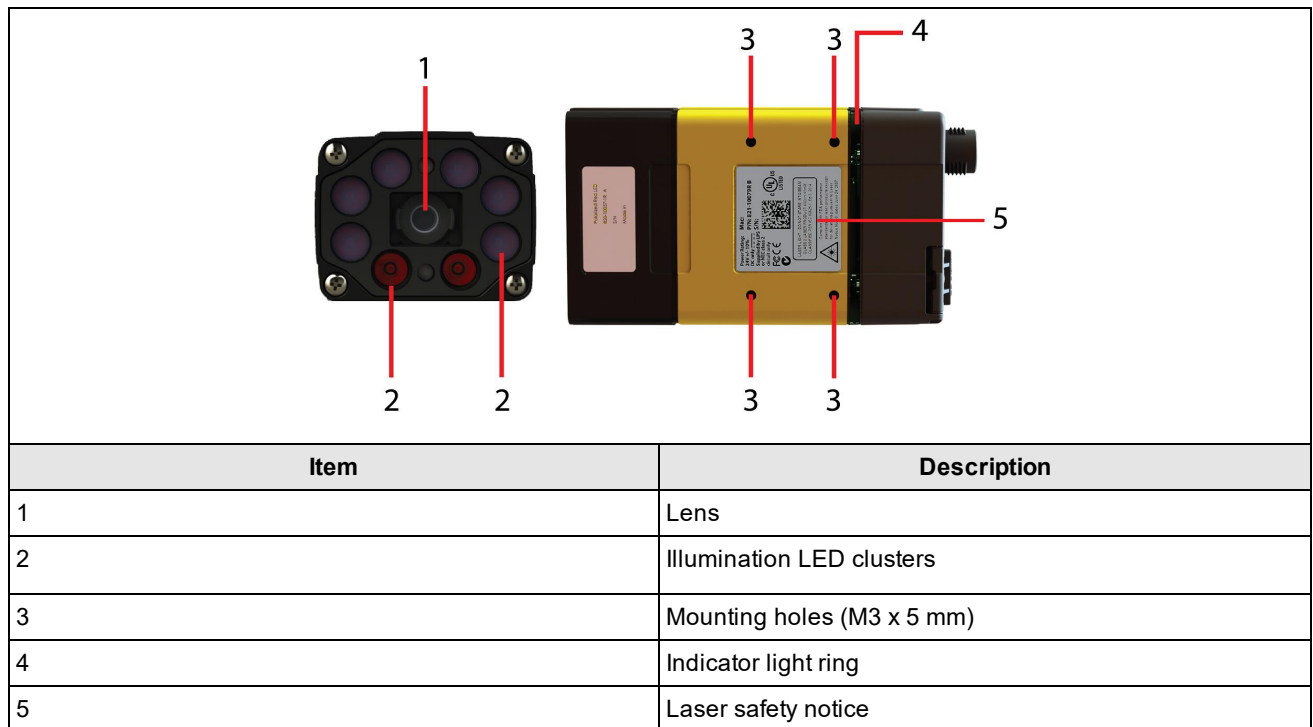

The image shows the back cover of the DataMan 370 and the functions of the indicator lights.

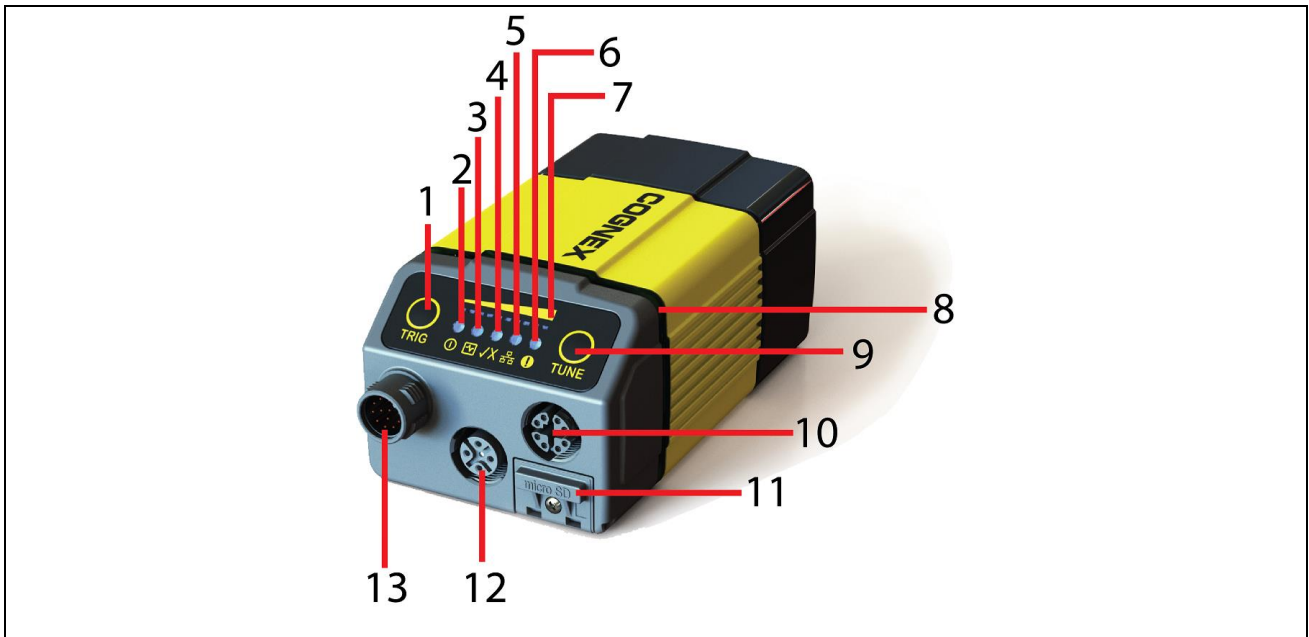

Item	Description
1	Trigger button
2	Power
3	Train status
4	Good/bad read
5	Network
6	Error
7	Peak meter
8	Indicator light ring
9	Tuning button
10	Ethernet
11	SD card slot
12	External light control
13	Power, I/O, and RS-232

The table explains the indicator light ring behavior.

Type	Signal	Color	Meaning
Status	Power	GREEN	Power ON
	Train status	GREEN	Trained
		YELLOW	Untrained
	Error	RED	Error - check device log

Type	Signal	Color	Meaning
Action	Good/bad read	GREEN	Good read
		RED	Bad read
	Communication	YELLOW	Link up
		<i>blink</i>	Activity
Peak meter	-	Decode yield, train progress/quality	

Dimensions

Note:



- Dimensions are in millimeters [inches] and are for reference purposes only.
- All specifications are for reference purposes only and can change without notice.

Observe the following DataMan 370 series reader dimensions when installing your reader.

DataMan 370

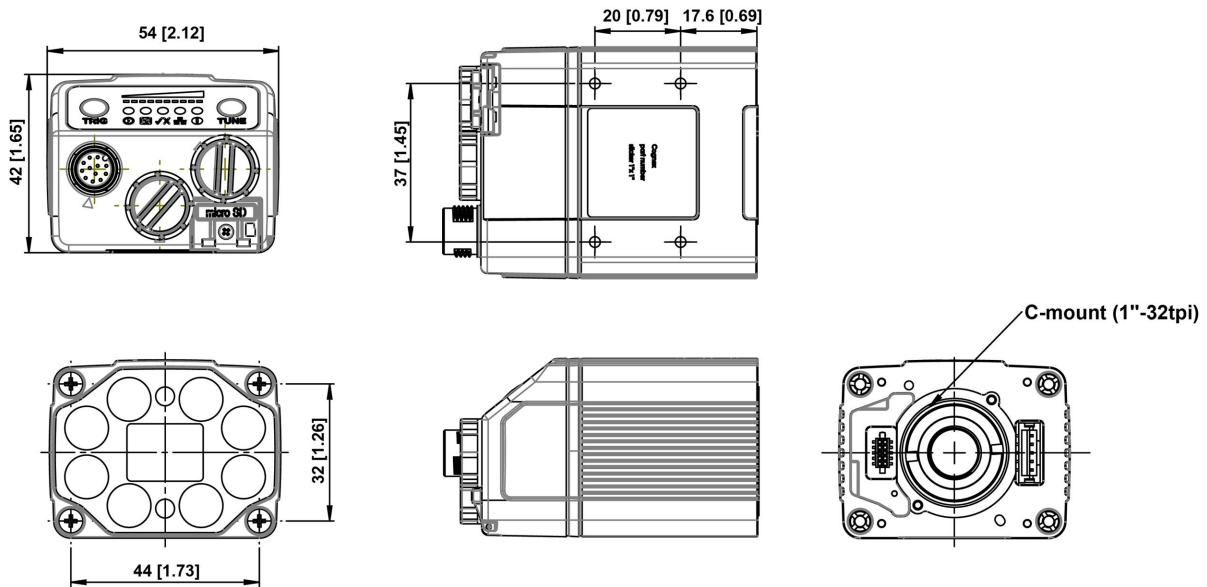

DataMan 370 with High Power Integrated Light (HPIL)

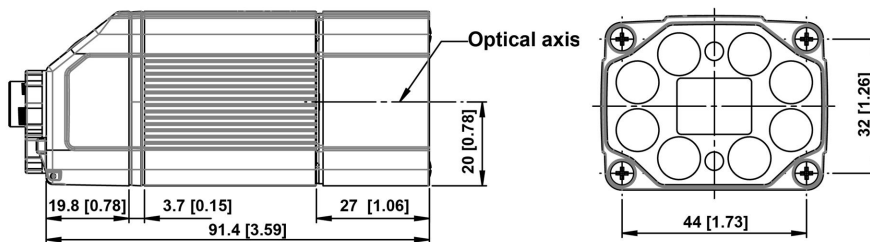

DataMan 370 with High Power Illumination Accessory (HPIA)

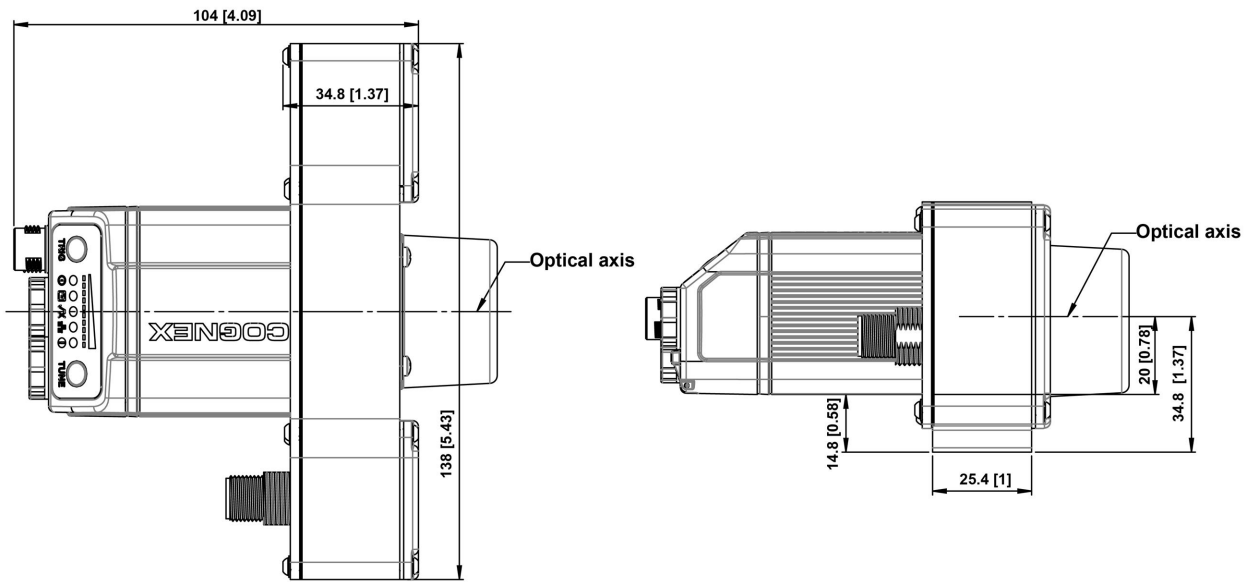

DataMan 370 Series with High Power Integrated Torch (HPIT)

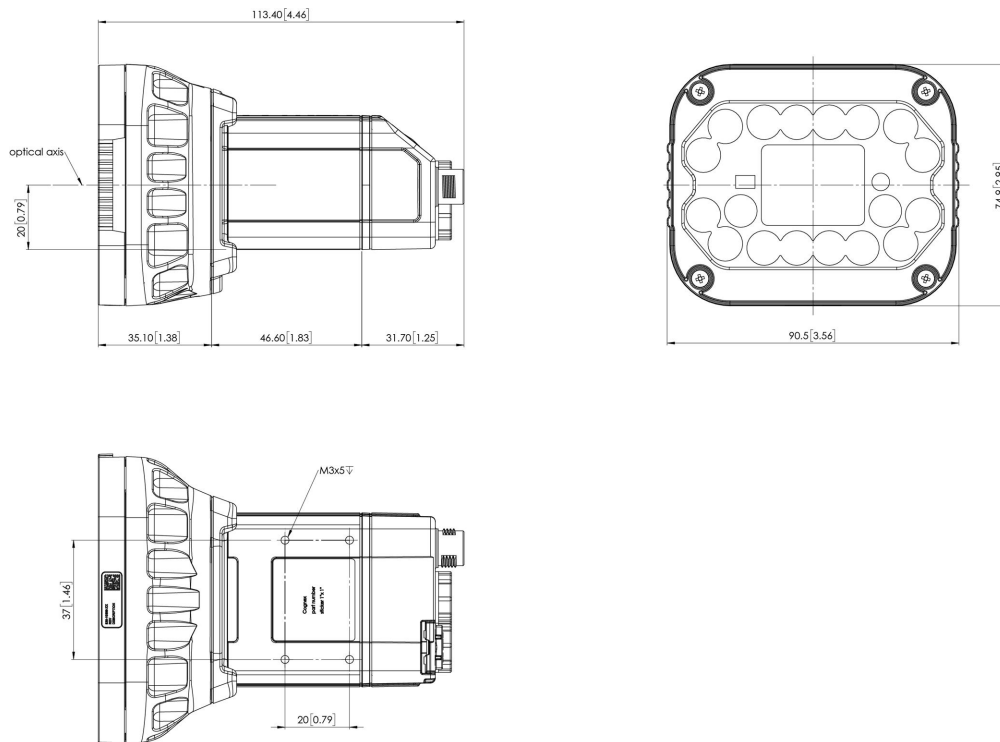



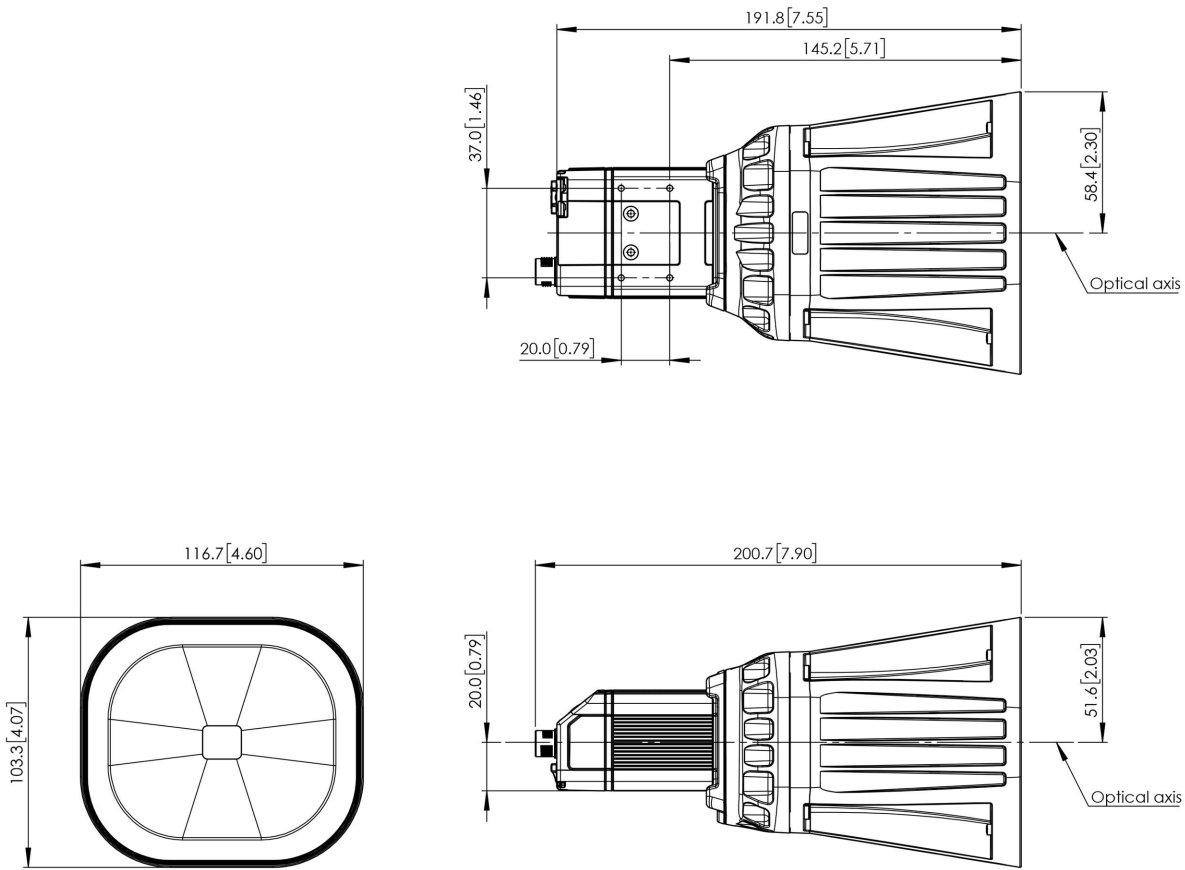

DataMan 370 Series with High Power Integrated Torch (HPIT) and Passive Diffuser



Assembling DataMan 370 Series Lens and Lights

You can choose between a variety of different (High-Speed) Liquid Lenses and C-Mount lens options to be installed on your DataMan 370 reader.

⚠ WARNING: Disconnect the DataMan 370 reader from power before installing the lens and light.

Assembly		Instructions
DataMan 374 + HPIL		Installing the Liquid Lens module with High Power Integrated Light (HPIL) on page 22
DataMan 37x + HPIA		Installing a Lens with High Power Illumination Accessory (HPIA) on page 26
DataMan 37x + HPIT		Installing High Power Integrated Torch (HPIT) on page 30
DataMan 37x + C-Mount		Installing a C-Mount Lens on page 34

Installing the Liquid Lens module with High Power Integrated Light (HPIL)

Possible hardware configurations using a liquid lens module with a DataMan 370 reader:

System	Liquid Lens	Lens part number	HPIL type
DM374	10.3 mm M12 lens with wrench and built-in IR blocking filter	DMLN-10LL-SMT	DM360-HPIL-RE DM360-HPIL-RE-P DM360-HPIL-WHI
	10.3 mm IR M12 lens with wrench, without built in IR blocking filter	DMLN-10LL-IR-SMT	DMLT-HPIL-IR-W
	24 mm F6 liquid lens module with built in IR blocking filter	DM360-LENS-24LL	DMLT-HPIL-RE DMLT-HPIL-RE-P DMLT-HPIL-WHI
	24 mm F6 liquid lens module without built-in IR blocking filter, with built-in daylight filter	DMLN-C24F06-LL-IR	DMLT-HPIL-IR-W
	24 mm F10 liquid lens module with built in IR blocking filter	DMLN-C24F10-LL	DMLT-HPIL-RE DMLT-HPIL-RE-P DMLT-HPIL-WHI

Possible hardware configurations using a high-speed liquid lens module with a DataMan 370reader:

System	High-speed Liquid Lens	Lens part number	Extension (DM300-EXT)needed?	HPIL type
DM374	8 mm F8 autofocus lens	DMLN-C8F08-HSLL	No	DM360-HPIL-RE DM360-HPIL-RE-P DM360-HPIL-WHI
	16 mm F8 autofocus lens	DMLN-C16F08-HSLL	Yes	DM360-HPIL-RE DM360-HPIL-RE-P DM360-HPIL-WHI
	24 mm F6 autofocus lens	DMLN-C24F06-HSLL	Yes	DMLT-HPIL-RE DMLT-HPIL-RE-P DMLT-HPIL-WHI

Tools needed:

- Wrench for lens locking ring (10.3 mm LL only - delivered by Cognex with Liquid Lens module)
- Phillips screwdriver

To install a 10.3 mm or a 24 mm liquid lens module of a DataMan 370 reader, perform the following steps:

⚠ WARNING: Disconnect the DataMan reader from power before continuing.

CAUTION: Do not leave the image sensor exposed to the environment.

1. Remove the adhesive protective film covering the threaded lens opening.

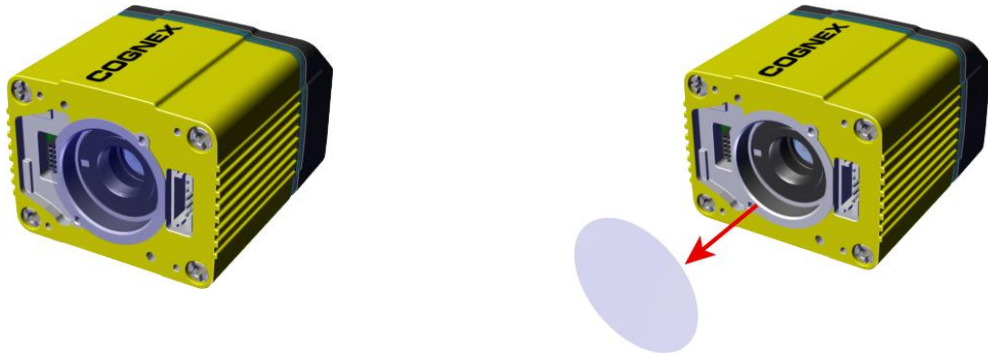

2. Attach the **24 mm Lens** to the device by using the screw thread on the metal ring.

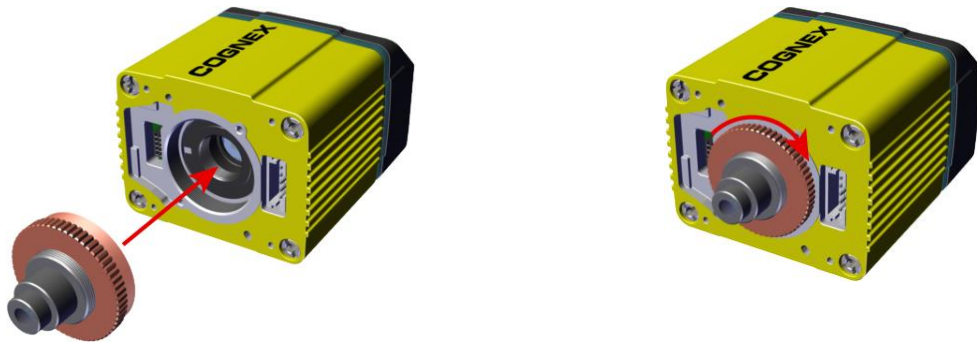

Insert an S-Mount adapter, thread the **10.3 mm Lens** into the reader, and tighten the locking ring.

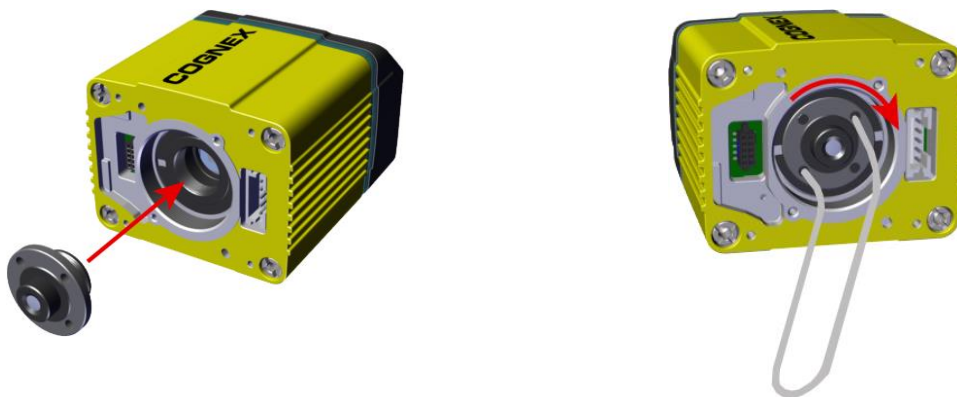

3. Insert the **Liquid Lens cable** into the connector of the reader.



⚠ WARNING: To avoid equipment damage, the cables must be routed as shown in the figure.

4. Attach the **Liquid Lens** to the front side of the **24 mm Lens**.



In case of the **10.3 mm Lens**, attach the liquid lens module onto the nose of the lens.



5. Place the **HPIL** unit on the front of the device.

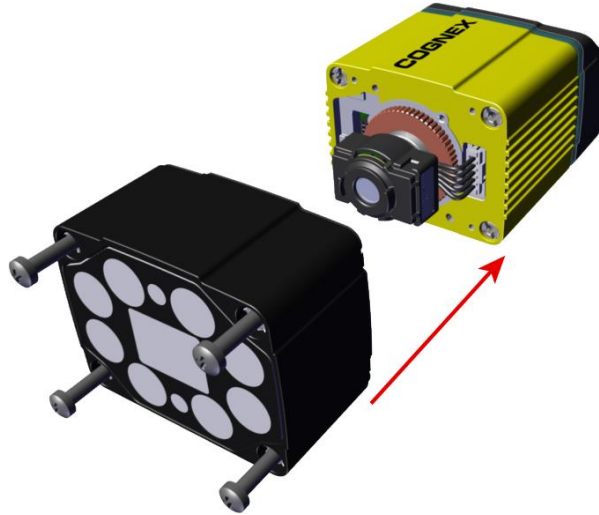

CUSTOMIZED CAPTIVE SCREW, PHILLIPS PAN HEAD, M3x28 mm

6. Screw in the four screws.

Note: Use 0.2 Nm torque on the screws and tighten in sequence.

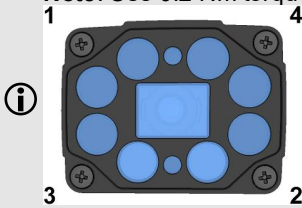

Installing a Lens with High Power Illumination Accessory (HPIA)

The HPIA is compatible with most lenses listed in [DataMan 370 Series Accessories on page 7](#)

System	C-mount lenses	Lens Part Number	Extension (DM500-LNSEXT-000) needed?	HPIA type
DM37x	8 mm F5.6	LEC-CFF08-F5.6	No	DM30X-HPIA3-625-W DM30X-HPIA3-WHI-W DM30X-HPIA3-470-W DM30X-HPIA3-IR
	12 mm F8	LEC-CFF12-F8	No	DM30X-HPIA3-625-W DM30X-HPIA3-WHI-W DM30X-HPIA3-470-W DM30X-HPIA3-IR
	16 mm F8	LEC-CFF16-F8	Yes	DM30X-HPIA3-625-W DM30X-HPIA3-WHI-W DM30X-HPIA3-470-W DM30X-HPIA3-IR
	25 mm F8	LEC-CFF25-F8	No	DM30X-HPIA3-625 DM30X-HPIA3-WHI DM30X-HPIA3-470 DM30X-HPIA3-IR
	35 mm F8	LEC-CFF35-F8	Yes	DM30X-HPIA3-625 DM30X-HPIA3-WHI DM30X-HPIA3-470 DM30X-HPIA3-IR
	40 mm F8	LEC-CFF40-F8	Yes	DM30X-HPIA3-625 DM30X-HPIA3-WHI DM30X-HPIA3-470 DM30X-HPIA3-IR
	50 mm F8	LEC-CFF50-F8	Yes	DM30X-HPIA3-625 DM30X-HPIA3-WHI DM30X-HPIA3-470 DM30X-HPIA3-IR

System	High-speed liquid lenses	Lens Part Number	Extension (DM500-LNSEXT-000) needed?	HPIA type
DM37x	8 mm F8 (autofocus)	DMLN-C8F08-HSLL	No	DM30X-HPIA3-625-W DM30X-HPIA3-WHI-W DM30X-HPIA3-470-W
	10 mm F5 (autofocus)	DMLN-C10F05-HSLL	No	DM30X-HPIA3-625-W DM30X-HPIA3-WHI-W DM30X-HPIA3-470-W
	16 mm F8 (autofocus)	DMLN-C16F08-HSLL	No	DM30X-HPIA3-625-W DM30X-HPIA3-WHI-W DM30X-HPIA3-470-W
	24 mm F6 (autofocus)	DMLN-C24F06-HSLL	No	DM30X-HPIA3-625 DM30X-HPIA3-WHI DM30X-HPIA3-470
	35 mm F8 (autofocus)	DMLN-C35F08-HSLL	No	DM30X-HPIA3-625 DM30X-HPIA3-WHI DM30X-HPIA3-470

Note: High-speed Liquid Lenses are not compatible with IR illumination

Tools needed:

- Wrench for lens locking ring (10.3 mm LL only - delivered by Cognex with Liquid Lens module)
- Phillips screwdriver (PH0)
- Phillips screwdriver (PH1)

To install a lens module of a DataMan 370 reader with HPIA, perform the following steps:

1. To install the **lens**, see:
 - [Installing a C-Mount Lens on page 34](#)
 - [Installing the Liquid Lens module with High Power Integrated Light \(HPIL\) on page 22](#)
 - [Installing High Power Integrated Torch \(HPIT\) on page 30](#)

2. Place the **HPIA** on the front of the reader.



3. Insert the **lens cover mounting plate** into the HPIA and secure them to the reader using the four M3 screws.

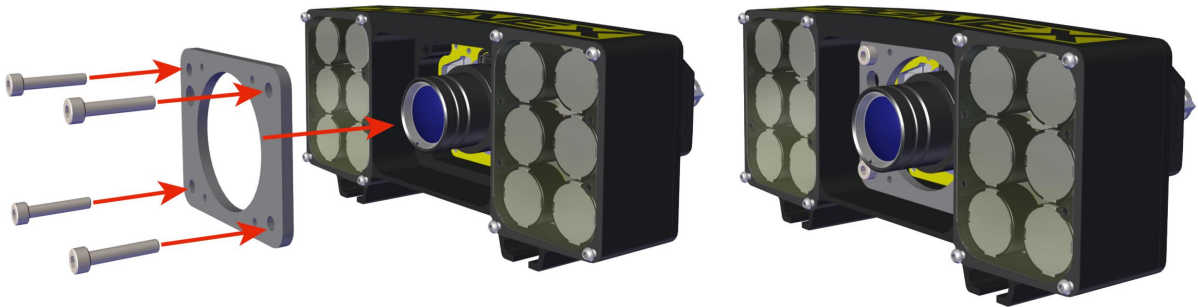

M3 x 16 mm screws

Note: Use a Phillips screwdriver (PH1) to torque the screws to 0.34 Nm (3 in-lb). Tighten in sequence.

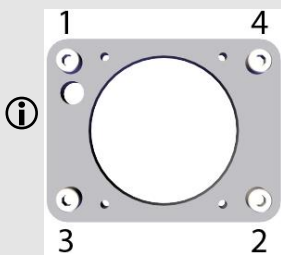

4. Attach the **C-mount lens cover** to the front of the plate and secure it using the four M2 screws.

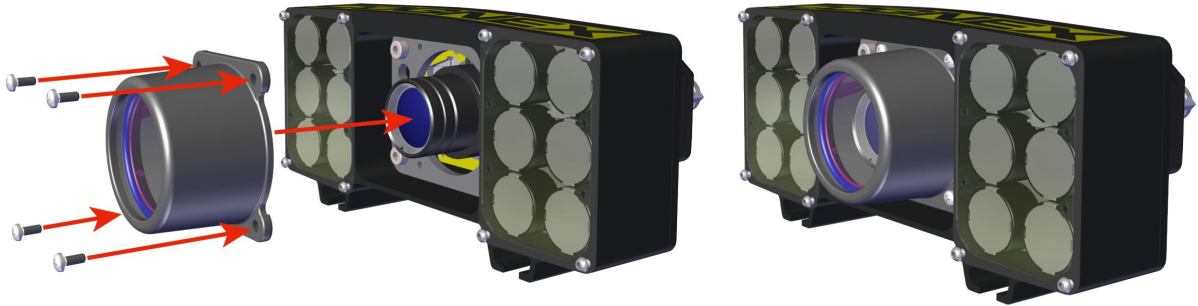

Note: For lenses that do not fit under the DM500-CMTLC-000 lens cover, using the DM500-LNSEXT-000 lens cover extension is required.

M2 x 5 mm screws

Note: Use a Phillips Screwdriver (PH0) to torque the screws to 0.09 Nm (0.8 in-lb). Tighten in sequence.

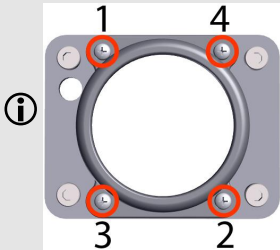

Installing High Power Integrated Torch (HPIT)

The possible hardware configurations using High Power Integrated Torch with a DataMan 370 reader are the following:

System	Lens	Lens part number	Light Type	Front cover
DM374 + DM370 adapter	10 mm F5 HSSL	DMLN-C10F05-HSSL	DMLT-HPIT-RE-W DMLT-HPIT-WHI-W	DMLA-HPIT-PLCOV (RED ONLY)
				DMLA-HPIT-PLCOV-F
				DMLA-HPIT-CLCOV
				DMLA-HPIT-DLCOV
	16 mm F8 HSSL	DMLN-C16F08-HSSL	DMLT-HPIT-RE-W DMLT-HPIT-WHI-W	DMLA-HPIT-PLCOV (RED ONLY)
				DMLA-HPIT-PLCOV-F
				DMLA-HPIT-CLCOV
				DMLA-HPIT-DLCOV
	24 mm F6 HSSL	DMLN-C24F06-HSSL	DMLT-HPIT-RE-S DMLT-HPIT-WHI-S	DMLA-HPIT-PLCOV (RED ONLY)
				DMLA-HPIT-PLCOV-F
				DMLA-HPIT-CLCOV
				DMLA-HPIT-DLCOV
35 mm F8 HSSL	DMLN-C35F08-HSSL	DMLT-HPIT-RE-N DMLT-HPIT-WHI-N	DMLA-HPIT-PLCOV (RED ONLY)	
			DMLA-HPIT-PLCOV-F	
			DMLA-HPIT-CLCOV	
			DMLA-HPIT-DLCOV	

Tools needed:

- 2 mm Allen wrench
- Phillips screwdriver (PH0)

Perform the following steps to mount the HPIT to your DataMan 370 reader:

1. Remove the adhesive protective film covering the threaded lens opening.

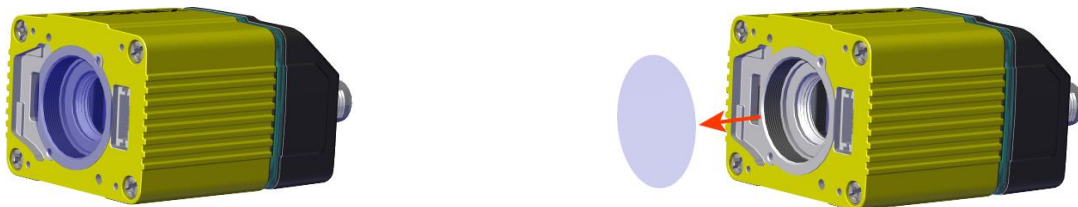

2. Add the small PCB into the light connector.



3. Attach the DM470 HPIT adapter plate.



M3 x 6 mm screws

Note: Use a 2 mm hex wrench to torque the screws to 0.34 Nm (3 in-lb). Tighten in sequence.

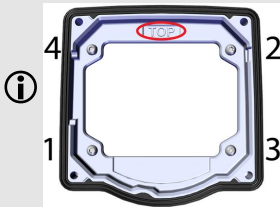

4. Attach the lens module and fix the lens with the captive screws.

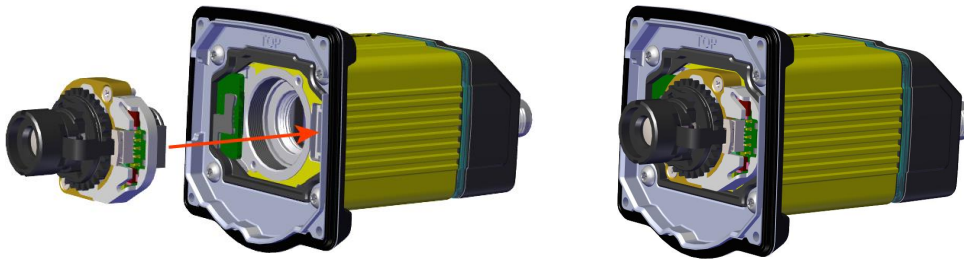

Note: Use a Phillips screwdriver (PH0) to torque the screws to 0,08 Nm (0.7 in-lb). Tighten in sequence.

- Do not push or pull the lens at its barrel – push or pull on the metal housing.
- Be careful not to touch the gear ring with the screwdriver.

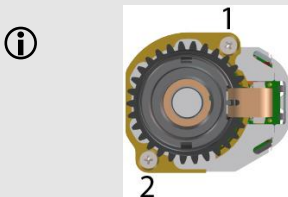

5. Attach the light module.

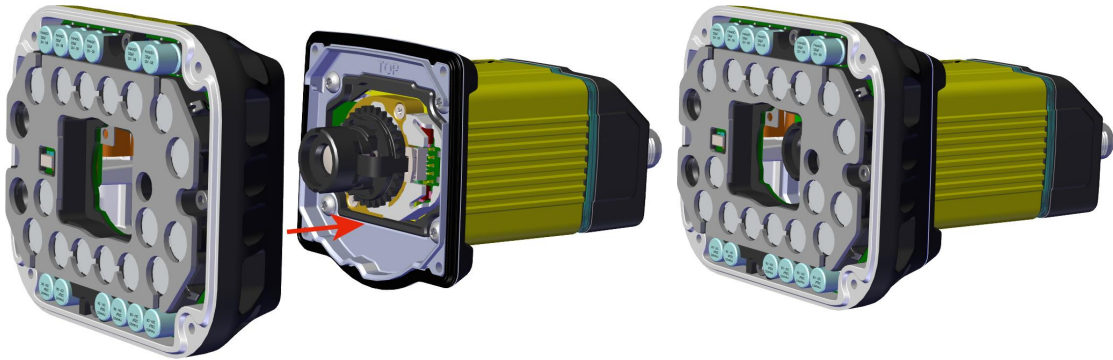

M3 x 6.35 mm captive screws

Note: Use a 2 mm hex wrench to torque the captive screws to 0.34 Nm (3 in-lb). Tighten in sequence.

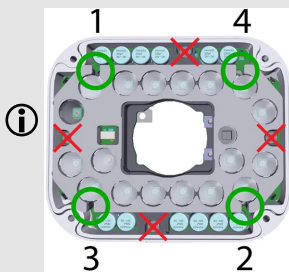

6. Attach the front cover.



M3 x 12 mm captive screws

Note: Use a Phillips Screwdriver (PH0) to torque the captive screws to 0.31 Nm (2.75 in-lb). Tighten in sequence.

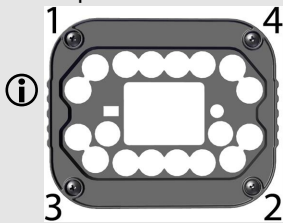

Note: Remove the adhesive protective film from the front cover after Step 6.

Note: When a passive dome front cover (DMLA-HPIT-DFCOV) is attached to Torch light, all light segments are turned ON by default and certain functions are unavailable:



- Laser aimer
- Distance sensor
- Indicator LEDs

Installing a C-Mount Lens

Possible hardware configurations using a C-Mount lens with a DataMan 370 reader:

System	Lens	Lens Part Number	C-Mount Cover (DM300-CMCOV)	Short C-Mount Cover (DM300-CMCOV-SH)
DM374	8 mm F5.6	LEC-CFF08-F5.6	✓	
	12 mm F8	LEC-CFF12-F8	✓	✓
	16 mm F8	LEC-CFF16-F8	✓	
	25 mm F8	LEC-CFF25-F8	✓	✓
	35 mm F8	LEC-CFF35-F8	✓	
	40 mm F8	LEC-CFF40-F8	✓	
	50 mm F8	LEC-CFF50-F8	✓	

1. Remove the adhesive protective film.

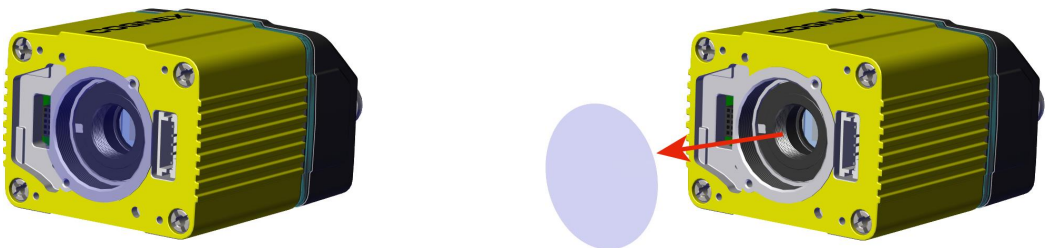

2. Thread the lens into the reader.

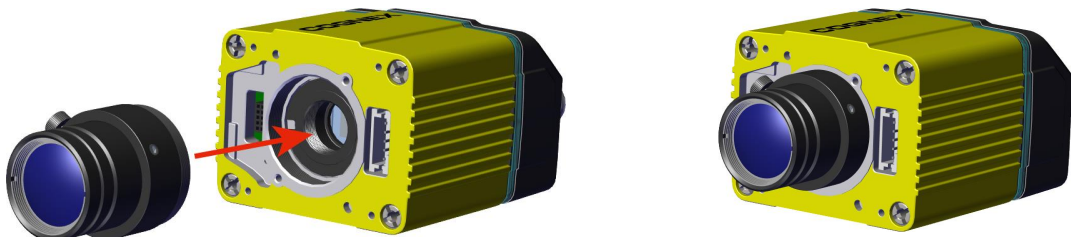

3. Place the reader at the desired working distance from focus target.

Note: Make sure to set focus for the reader before fitting the lens cover.

- a. Connect the reader to the DataMan Setup Tool.
- b. Navigate to the **Optimize Image** pane, and on the **Basic** tab, click the triangle on the **Live** button to access the drop-down list, and check the **Focus Feedback** option. See [Setting Focus on page 42](#)
- c. Use the DataMan Focus Target template, available through the Windows **Start** menu or the DataMan Setup Tool **Help** menu, to align the edge of the reader body to the line marked with the target distance used in your application.
- d. Adjust focus for maximum sharpness. Enhance image quality in the DataMan Setup Tool for better guidance.

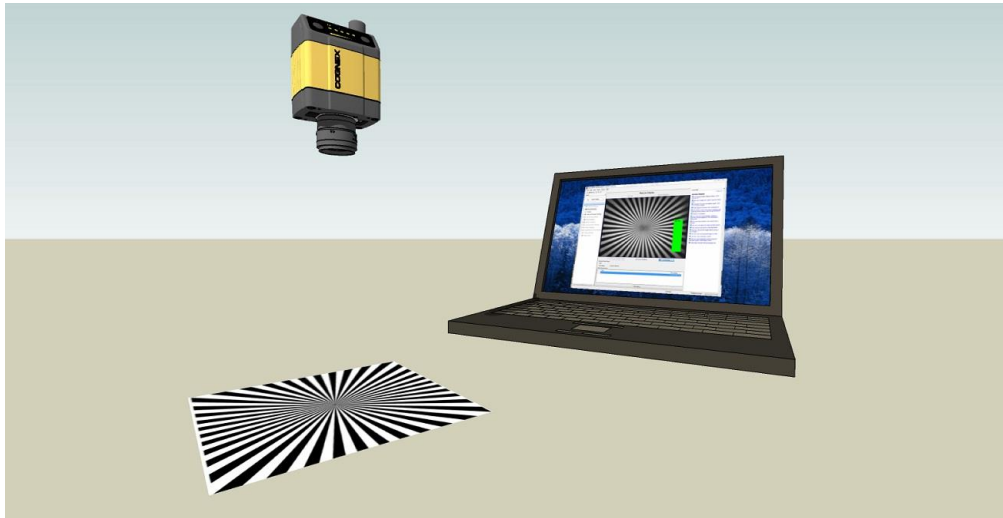

4. Attach the C-Mount cover base.

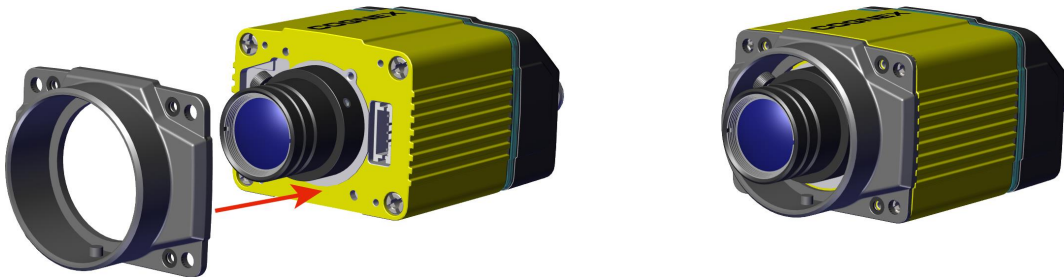

5. Add the screws to the C-Mount cover base.

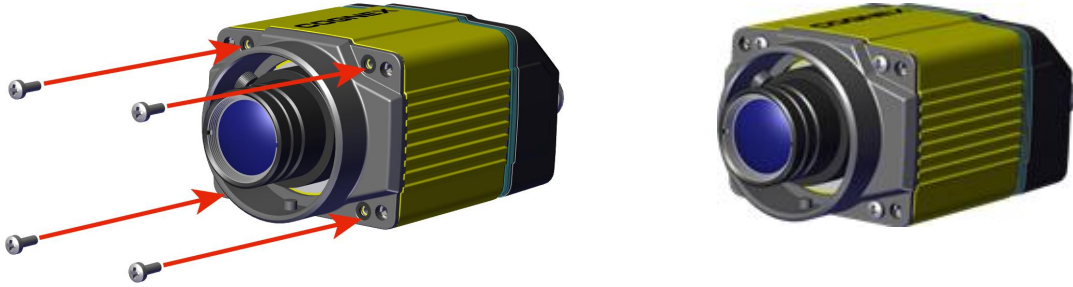

PHILLIPS PAN HEAD M2 X 6 mm

Note:
Tighten in sequence. Torque limit: 9 Ncm (0.8 in-lbs).

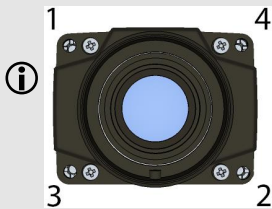

6. Attach the front cover.

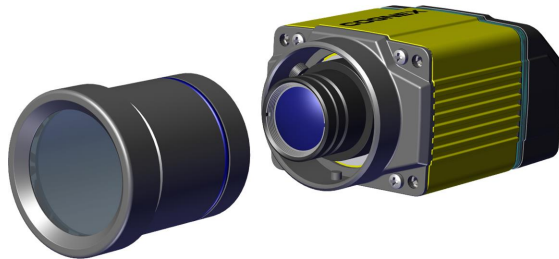

Note: Do not unscrew the front-most part of the nose of the cover to avoid risking the glass lens falling out.

7. Align the peg on the reader and the slot on the cover so that the cover locks in place.

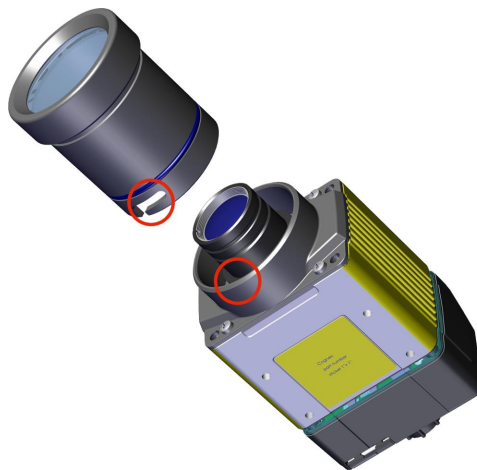

Connecting External Illumination to DataMan 370

You can connect the following external lights to the external light control port of the DataMan 370:

- Bar light (IVSL-YLW2X-xxx, IVSL-LX520-xxx, IVSL-LX800-625)
- LX280-series light (IVSL-LX280-xxx)

Single Light

Note: The images show a DM470 series reader connected to the external lights, but you can connect external lights to a DM360, and DM370 series reader in the same way.

External light IVSL-YLW2X-xxx or IVSL-LX520-xxx connected to DM360 / DM370 / DM470:



External light IVSL-LX280-xxx connected to DM360 / DM370 / DM470:



External light IVSL-LX800-625 connected to DM370 / DM470:

Note: IVSL-LX800-625 comes with a 5-Pin M12 Connector.



Multiple Lights

Follow these steps to connect two or more bar lights (IVSL-YLW2X or IVSL-LX520-xxx):

1. Connect the lights with cable IVSL-5PM12-Jxxx.
2. Connect the light to the DM370 with cable CCB-FOV25-MAL-012.
3. Cut and isolate brown wire (24 VDC) and blue wire (GND) from cable IVSL-5PM12-5 connected to the other light.

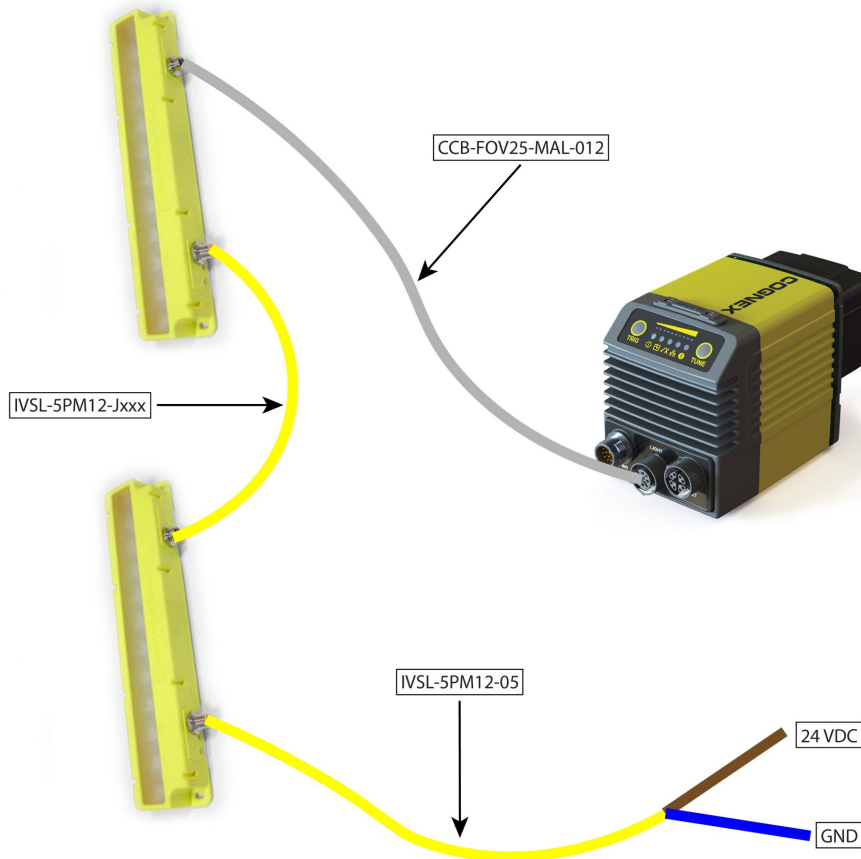

Follow these steps to connect two or more bar lights:

1. Create a panel where all cables come together
2. Connect the lights to the panel with cable IVSL-FSK-J5000
3. Connect the DM370 with cable CCB-M12XFLY-05

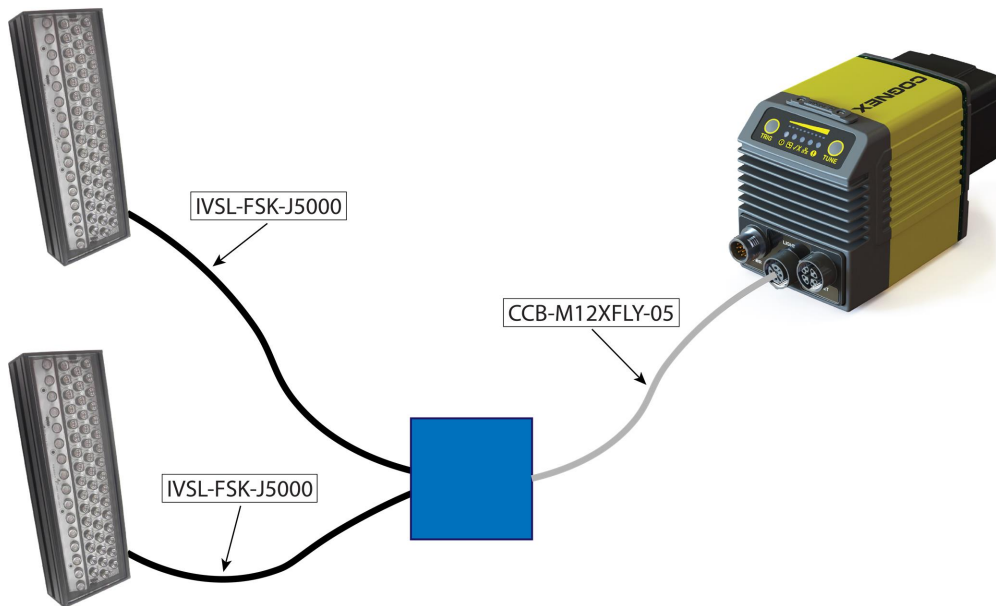

Inside the panel you need to:

1. Cut and isolate brown (24V) wire from CCB-M12XFLY-05
2. Cut M12 connector from IVSL-FSK-J5000
3. Strip open end from IVSL-FSK-J5000

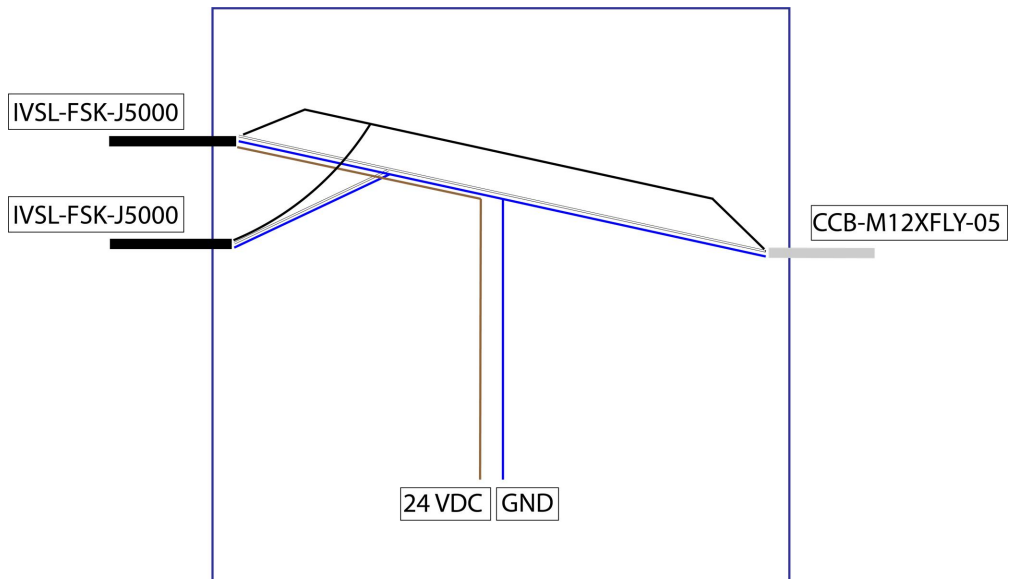

4. Connect all black wires together
5. Connect all white wires together

6. Connect all blue wires together
7. Connect brown wires from IVSL-FSK-J5000 together
 - Cut off brown wire from CCB-M12XFLY-05
8. Connect blue wires to GND
9. Connect brown wires to 24 VDC

Note: For more details on the External Light Control, see [External Light Control \(CCB-M12XFLY-05\) on page 64](#)

Mounting the Reader

The reader provides mounting holes for attachment to a mounting surface.

The accessory mounting bracket kit (DMBK-370-MNT) includes the mounting bracket, four Phillips flat head M3 DIN 965 screws for attaching the reader to the mounting bracket and four M6 DIN 912 (ISO 4762) screws for securing the bracket to a mounting surface.

CAUTION: It is recommended the reader be grounded, either by mounting the reader to a fixture that is electrically grounded or by attaching a wire from the reader's mounting fixture to frame ground or Earth ground. If a ground wire is used, it should be attached to one of the four mounting points on the back plate of the reader; not to the mounting points on the front of the reader.

1. Align the holes on the mounting surface with the mounting holes on the reader.

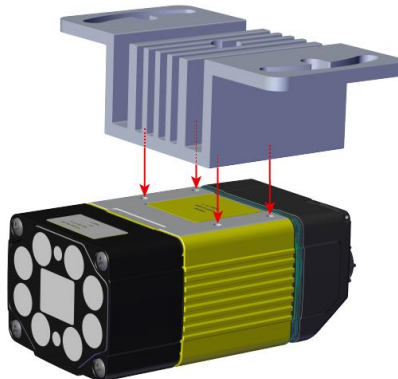

2. Insert the M3x5, DIN 965 (4x) screws into the mounting holes.

Note: Use a 2.5 mm hex wrench to torque the captive screws to 0.60 Nm (5 in-lb). Tighten in sequence.

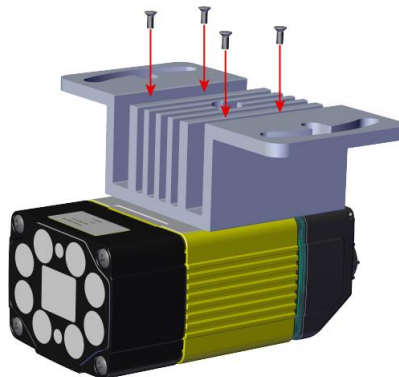

3. Align the mounting holes on the mounting plate with the M6 drop-in nuts and the M6, DIN 912 (ISO 4762) socket head screw in the mounting surface.

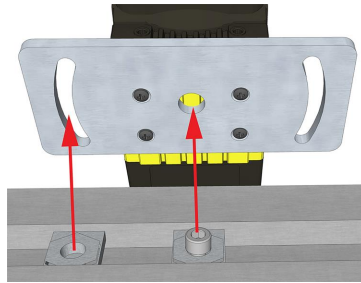

4. Attach the mounting bracket to the mounting surface using M6, DIN 912 (ISO 4762) socket head screws with M6 drop-in nuts for OTS aluminum profiles.

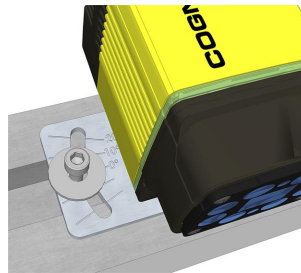

Mounting the DataMan reader at a slight angle (15°) can reduce reflections and improve performance.

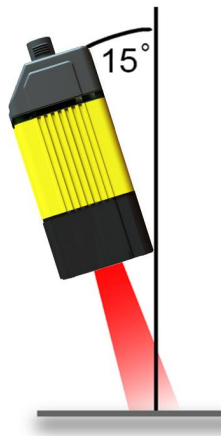

Setting Focus

There is a range of reading distances available for different code sizes and focus positions. To set focus on your reader, use the following options depending on whether you use a liquid lens or a manual focus lens.

DataMan readers are compatible with multiple different lenses. Each lens has a range of reading distances available for different code sizes and focus positions. Having accurate focus settings is essential to maximize read rates.

To set the focus on your reader, use the following options depending on whether you use a liquid lens or a manual focus lens.

Liquid Lens

1. Click the **Focus Feedback** button in the image panel in SetupTool to enable focus feedback. This enables a color-coded focus feedback bar on the right side of the image panel.

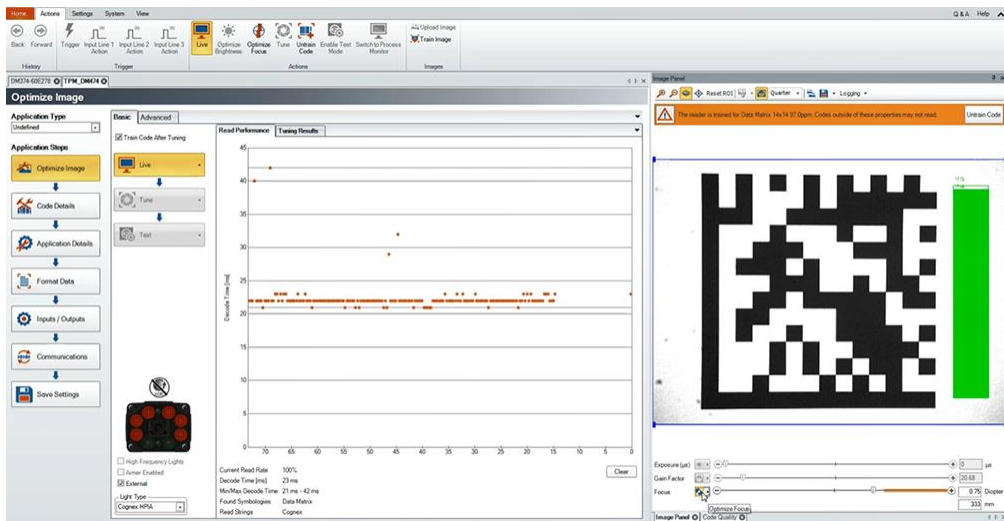
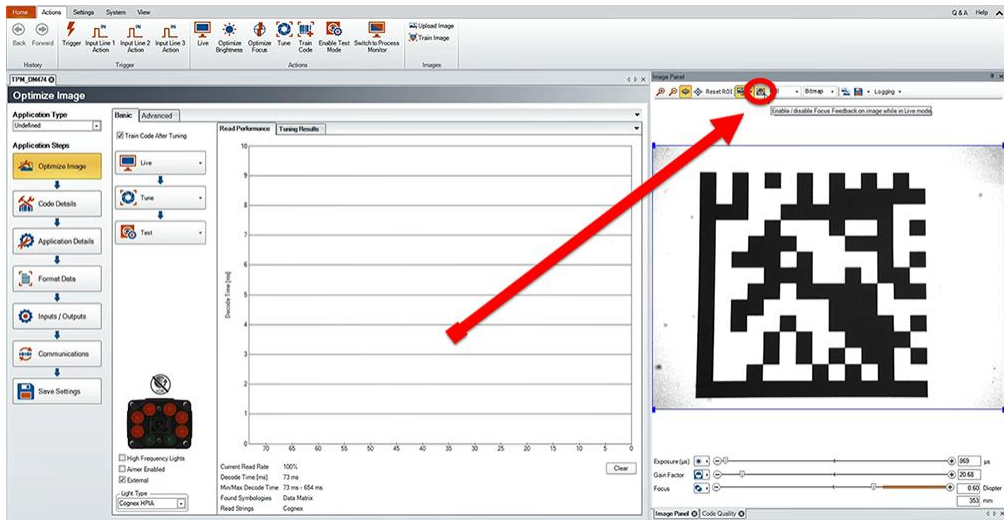

- Click the **Optimize Focus** button to optimize the focus of the liquid lens. You can find this button in the lower left section of the image panel, or you can also optimize focus during tuning by checking the box in the tune dropdown.

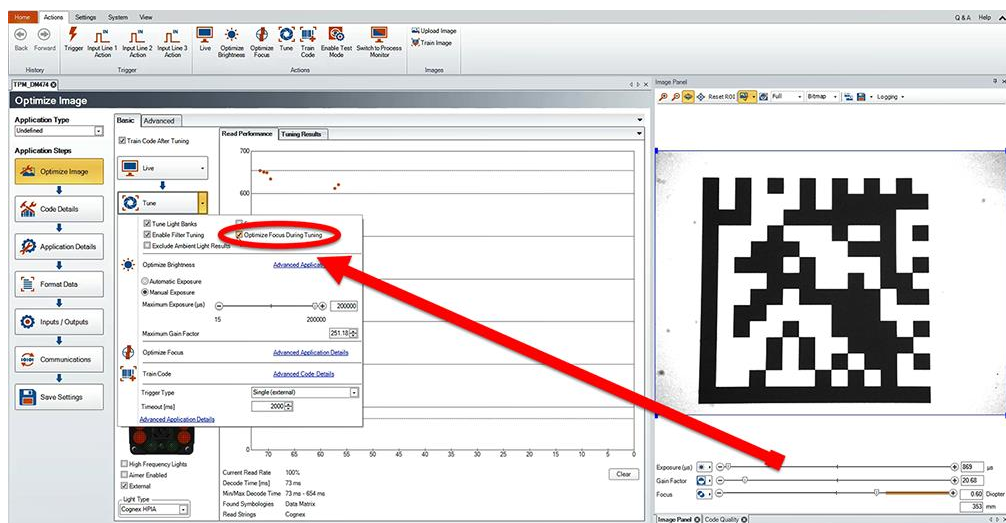
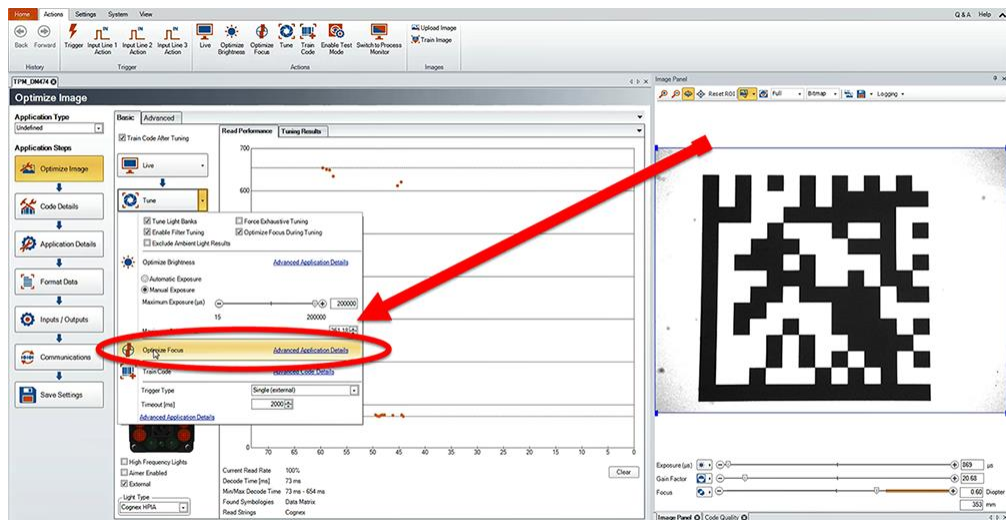
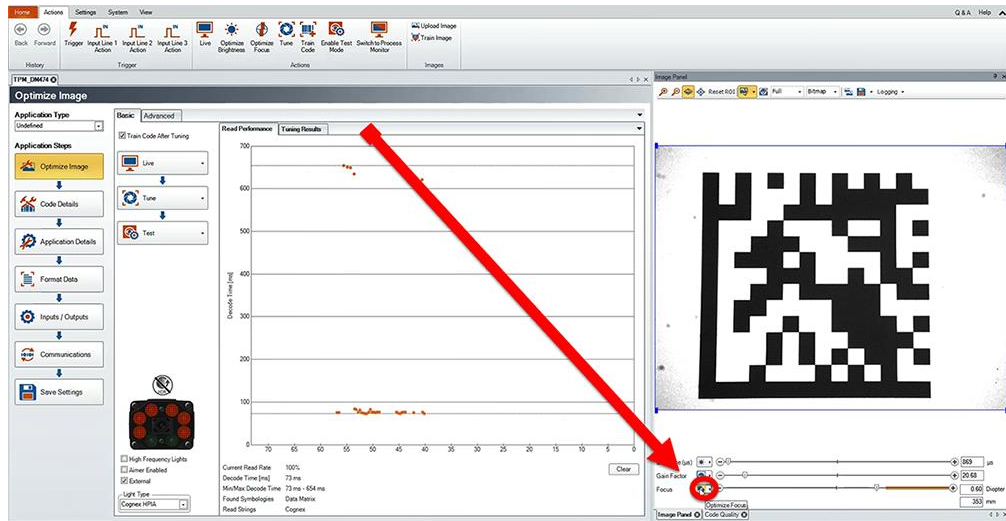

Manual Focus Lens

Click the **Focus Feedback** button in the image panel in SetupTool to enable focus feedback.

This enables a color-coded focus feedback bar on the right side of the image panel. Once focus feedback is enabled, enter live mode and manually adjust the lens until the focus feedback bar is green.

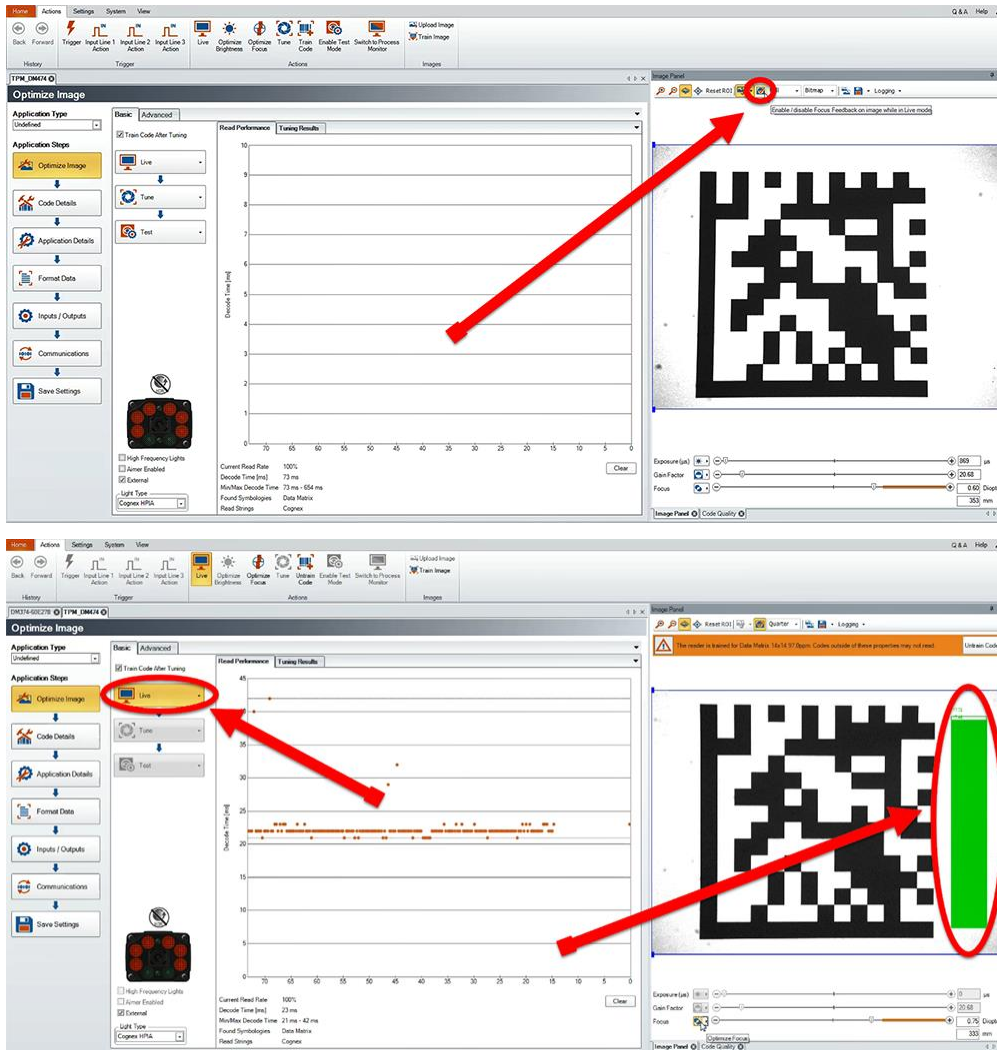

Focus Feedback

Focus is indicated by colors ranging from red (bad focus) to green (sharp focus). When focusing the reader, you need to adjust its position until the focus column becomes green.

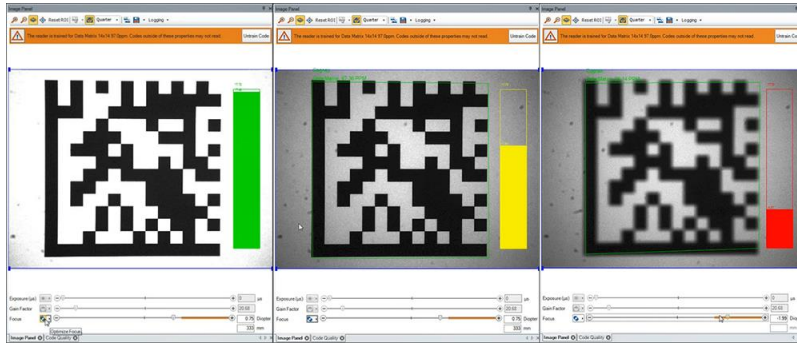

Best Practices

Both **Optimize Focus** and the **Focus Feedback** use the same procedure for testing the current focus. They consider various sub-regions of the image.

Follow these guidelines to maximize the performance of **Optimize Focus** and **Focus Feedback**:

- Use a focus target (such as the one supplied with this Reference Manual) that includes high-contrast features and is big enough that it fills at least a 100x100 pixel region in the center of the field of view at the desired working distance.
- Avoid floppy pieces of paper and make sure the target is perfectly flat.
- Make sure that the target is perfectly perpendicular to the optical axis of the reader.
- Make sure that the rest of the field of view, such as the part not covered by the focus target, does not contain any high-contrast features. For example, if you would ideally fill the entire field of view with a white card or sheet of paper (no shadows), position the focus target in the middle.
- The supplied 120x120mm focus target is appropriate for typical working distances. If you use such a working distance that the target does not completely fill the image, make sure that there are no high-contrast features visible outside of the target (see previous bullet).

Note:



- If you use the focus feedback indicator to adjust a manual focus lens, you must apply power to the reader before you remove the cover. If you remove the cover before applying power, the internal illumination will not function.
- If you use a Liquid Lens, make sure that the cover is mounted and connected before you apply power. If you attach or remove the front cover while the reader is powered, the focus setting is lost.

Field of View and Reading Distances

The following maps show the field of view of the DataMan 370 series readers. Reading distance values are also provided for 1-D and 2-D example code distances.

For the C-mount (or other non-Cognex) and S-Mount lenses, the focal length of the lens, focus setting, and aperture setting determine the field of view and reading distance.

The ruler shows the reading distance range. The grid with the FOV cone shows horizontal and vertical FOV values above the arrows.

Note: Due to tolerances, ranges can vary by +/- 5 % from unit to unit.

Reading Distance and Field of View (DataMan 370 Readers with a 8 mm High-Speed Liquid Lens)

The following map shows the FoV of the DataMan 370 series readers with an 8 mm high-speed liquid lens.

The FoV values are shown as follows:

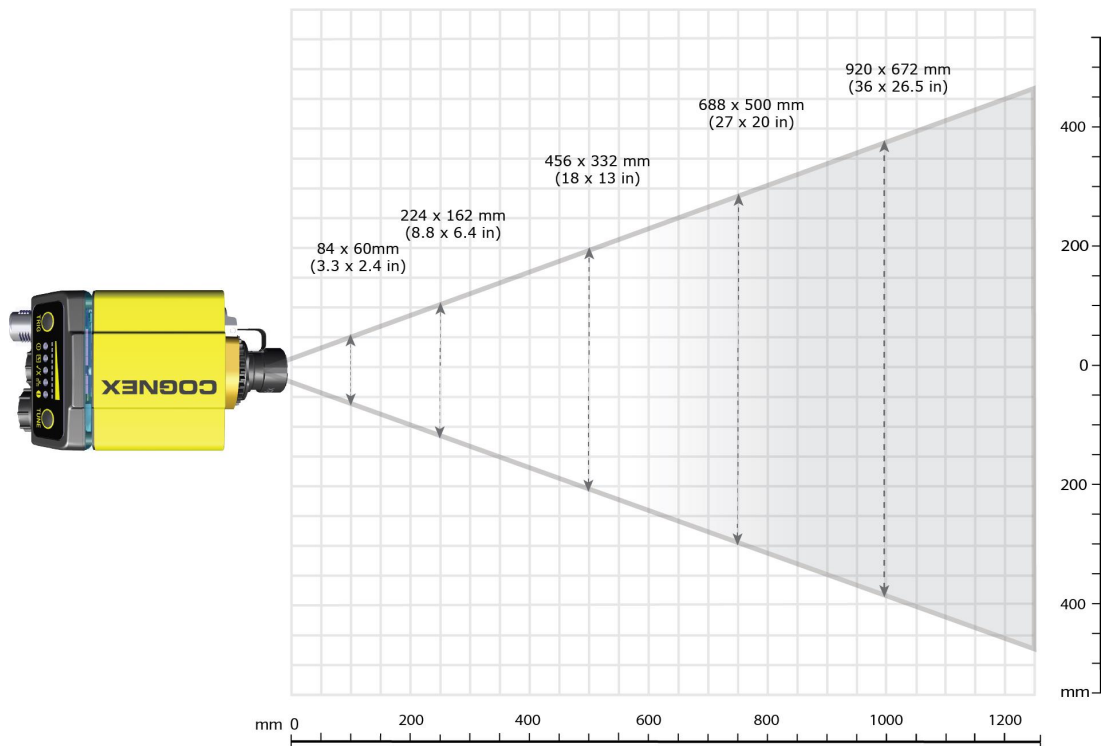

Device	Distances in mm / 1D min code 8 mm HSSL		Distances in mm / 2D min code 8 mm HSSL	
	DM374	235	5 MIL	140
350		7.5 MIL	210	7.5 MIL
470		10 MIL	280	10 MIL
930		20 MIL	560	20 MIL

Reading Distance and Field of View (DataMan 370 Readers with a 10 mm High-Speed Liquid Lens)

The following map shows the FoV of the DataMan 370 series readers with a 10 mm high-speed liquid lens.

The FoV values are shown as follows:

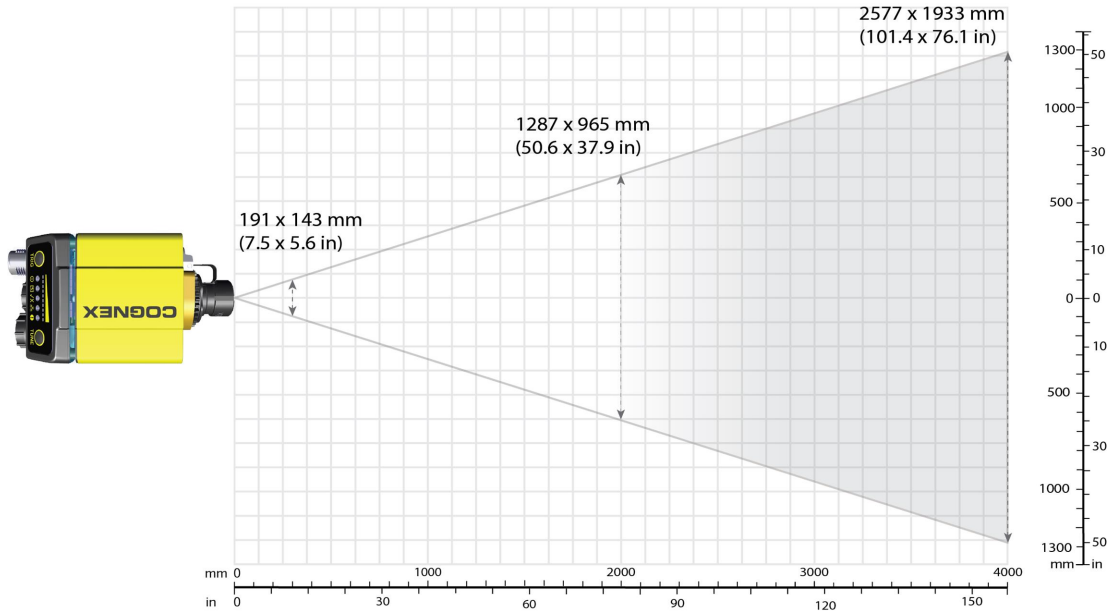

Device	Distances in mm / 1D min code 10 mm HSL		Distances in mm / 2D min code 10 mm HSL	
	DM374	445	6 MIL	307
591		8 MIL	408	8 MIL
738		10 MIL	509	10 MIL
958		13 MIL	660	13 MIL
1104		15 MIL	761	15 MIL
1471		20 MIL	1013	20 MIL

Reading Distance and Field of View (DataMan 370 Readers with a 16 mm High-Speed Liquid Lens)

The following map shows the FoV of the DataMan 370 series readers with a 16 mm high-speed liquid lens.

The FoV values are shown as follows:

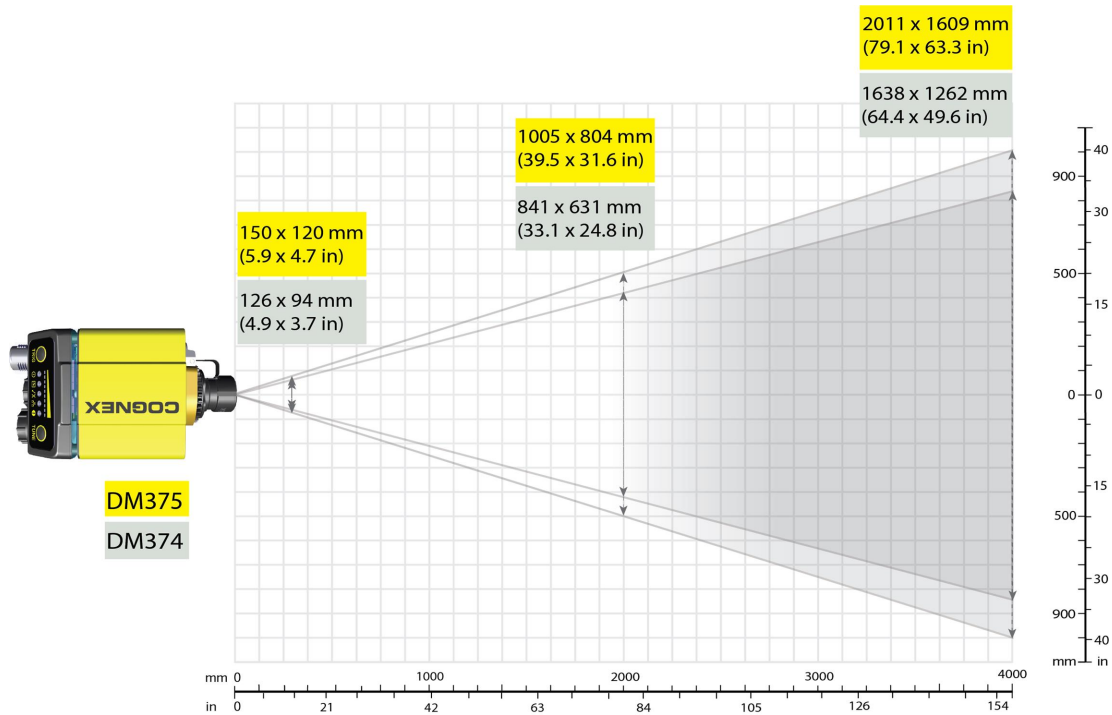

Device	Distances in mm / 1D min code 16 mm HSL		Distances in mm / 2D min code 16 mm HSL	
	DM37x	676	6 MIL	465
901		8 MIL	620	8 MIL
1125		10 MIL	774	10 MIL
1462		13 MIL	1006	13 MIL
1687		15 MIL	1160	15 MIL
2249		20 MIL	1547	20 MIL

Reading Distance and Field of View (DataMan 370 Readers with a 24 mm High-Speed Liquid Lens)

The following map shows the FoV of the DataMan 370 series readers with a 24 mm high-speed liquid lens.

The FoV values are shown as follows:

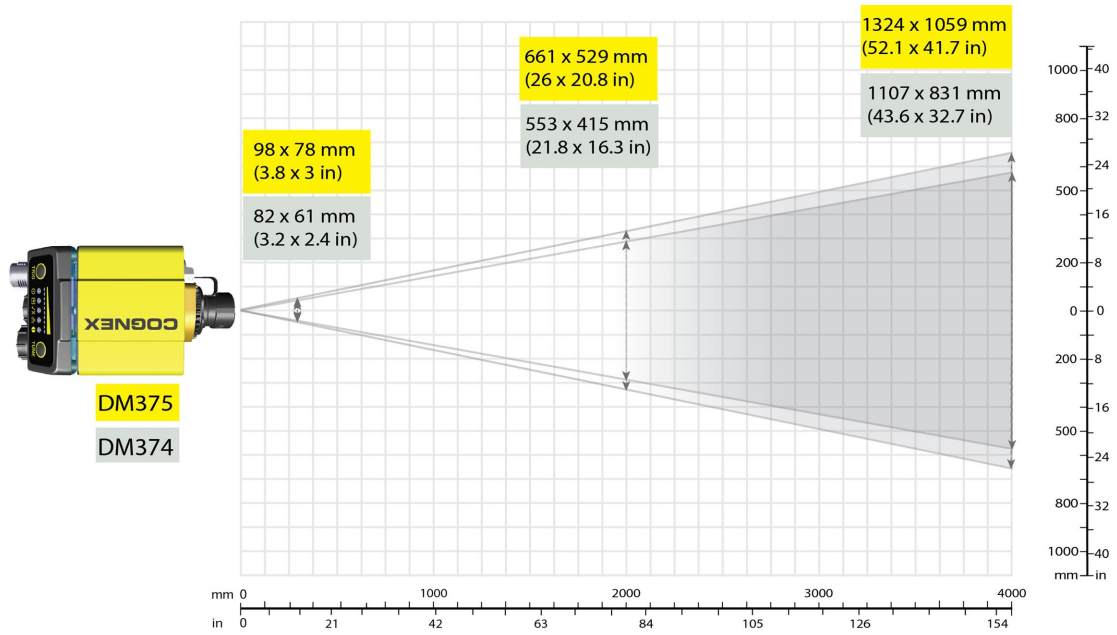

Device	Distances in mm / 1D min code 24 mm HSL		Distances in mm / 2D min code 24 mm HSL	
	DM37x	1029	6 MIL	709
1370		8 MIL	944	8 MIL
1711		10 MIL	1178	10 MIL
2223		13 MIL	1530	13 MIL
2564		15 MIL	1764	15 MIL
3417		20 MIL	2351	20 MIL

Reading Distance and Field of View (DataMan 370 Readers with a 35 mm High-Speed Liquid Lens)

The following map shows the FoV of the DataMan 370 series readers with a 35 mm high-speed liquid lens. The FoV values are illustrated with a DM374 reader.

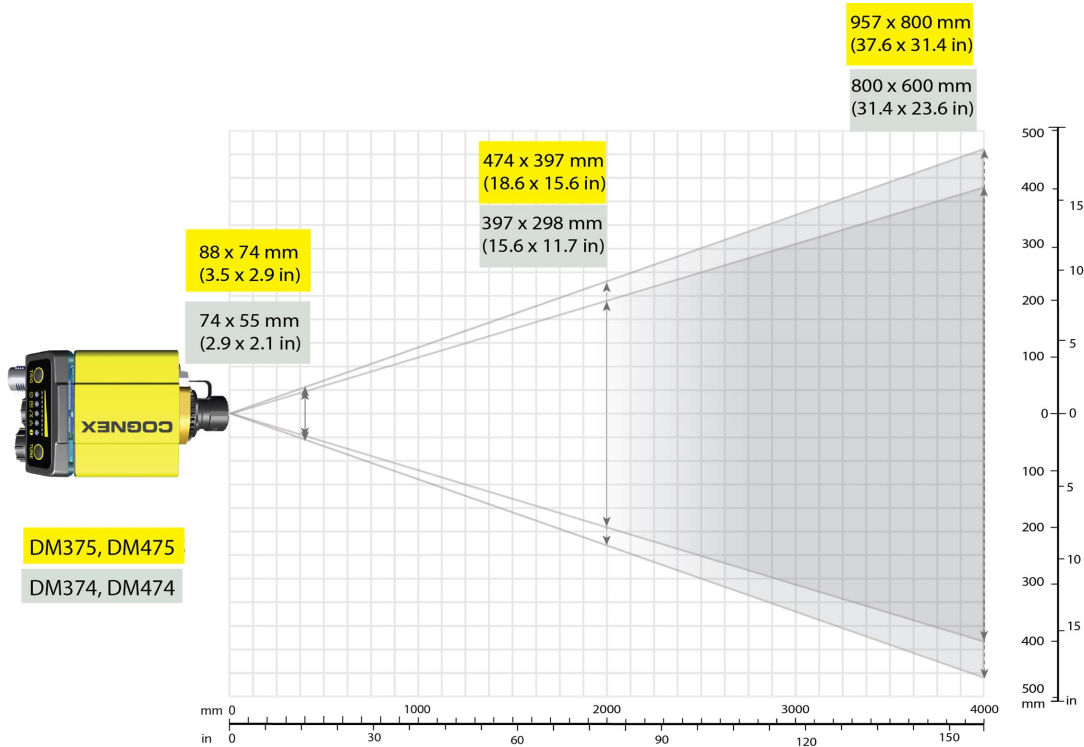

DM375, DM475
DM374, DM474

Device	Distances in mm / 1D min code 35 mm HSL		Distances in mm / 2D min code 35 mm HSL	
	DM37x	1300	6 MIL	835
1750		8 MIL	1110	8 MIL
2170		10 MIL	1390	10 MIL
2820		13 MIL	1800	13 MIL
3250		15 MIL	2080	15 MIL
4335		20 MIL	2770	20 MIL

Maintenance

Replacing the SD Card

The reader is equipped with a Micro SD card slot and an SD card is pre-installed for saving backup and configuration files. In the unlikely event when a reader breaks down and needs to be replaced, complete the following steps to clone the reader by replacing the SD card.

Note: The reader supports SD cards with a maximum capacity of 8 GB, formatted with a FAT32 file system.

CAUTION:



- Hot-plugging the SD card is not supported and may damage the SD card and/or lead to unexpected behavior. The SD card has to be present already at the boot phase. Do not pull out the SD card during operation.
- Observe ESD precautions when installing or removing an SD card or other accessories.

1. Disconnect the reader from the power source.
2. Unscrew the screw in the Micro SD card cover to open the card slot.
3. Remove the existing SD card from the Micro SD card slot.
4. Insert the SD card from the broken reader into the Micro SD card slot to clone the old reader. Ensure the card is properly oriented.
5. Replace the SD card cover and reinsert the screw.

Note: Torque the screw to 0.18 Nm (25 in-oz). Tighten in sequence.



6. Restore power to the reader.

Additional Information

DataMan 370 Series Reader Imager Specifications

Specification	DataMan 374 Imager	DataMan 375 Imager
Image Sensor	1/1.8 inch CMOS	2/3 inch CMOS, global shutter
Image Sensor Properties	7.2 mm x 5.4 mm (H x V); 3.45 µm square pixels	8.8 mm x 6.6 mm (H x V); 3.45 µm square pixels
Image Resolution (pixels)	2048 x 1536	2448 x 2048
Electronic Shutter Speed	Minimum exposure: 15 µs Maximum exposure: 25 ms with internal illumination/100000 µs with external illumination	Minimum exposure: 15 µs Maximum exposure: 25 ms with internal illumination/100000 µs with external illumination
Image Acquisition at Full Resolution	Max. 55 Hz	Max. 37 Hz
Lens Type	See DataMan 370 Series Accessories on page 7	

Limitations to C-Mount lenses:

- The length of the thread may not exceed 5.4 mm.
- For a chosen lens, the distance from the C-mount shoulder to the bottom of the lens may not exceed 5.4 mm. Possibly, a lens spacer is required.
- When using the C-Mount lens cover, lens dimensions including spacer and filters may not exceed 32 x 42 mm (diameter x length).

LED and Laser Wavelengths

The following table shows LED types and the related peak wavelengths:

LED	λ [nm]
WHITE	6500K (Color Temperature)
BLUE	470
RED	617
HIGH POWER RED	617
IR	850
TORCHLIGHT - WHITE	2500-5000K (Color Temperature)
TORCHLIGHT - RED	625

Using Your DataMan 370 Reader

This section provides information on the installation process of the DataMan Setup Tool, troubleshooting Ethernet connection issues, tuning, image filtering, as well as reader training and package detection.

Reading your first Code

Follow the steps below to install and connect your reader to the DataMan Setup Tool:

1. Download the latest version of the DataMan Setup Tool from <http://www.cognex.com/support/dataman> and follow the on-screen steps.
2. Check the DataMan **Release Notes** for a full list of system requirements found at C:\Program Files (x86)\Cognex\DataMan\DataMan Software v6.1.9\Documentation\English.
3. Connect the DataMan 370 Series reader to your PC using the x-coded Ethernet cable or the RS-232 cable and power the reader using the breakout cable. See [Connections, Optics, and Lighting on page 64](#) for breakout cable pinouts.

 **Note:** *See appendix for use with IO Box.

4. Launch the DataMan Setup Tool and click **Refresh**.

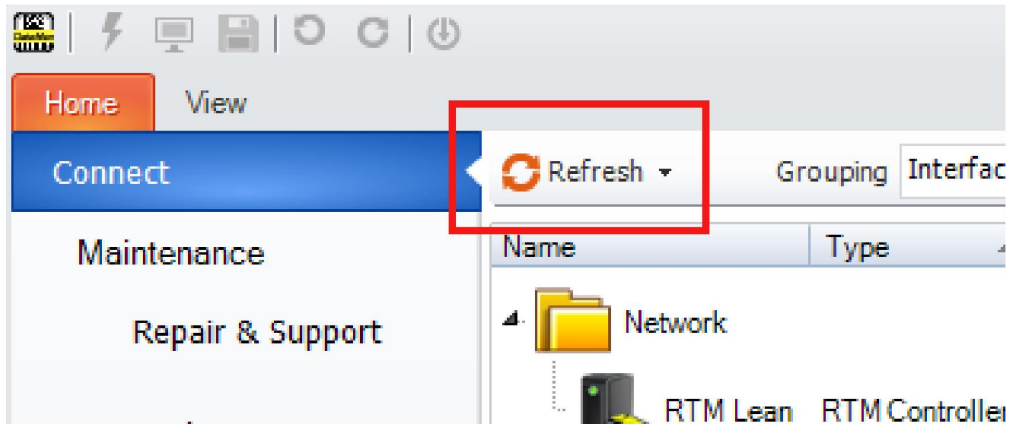

Note: Detected readers appear under **COM ports** or **Network devices**, or both.

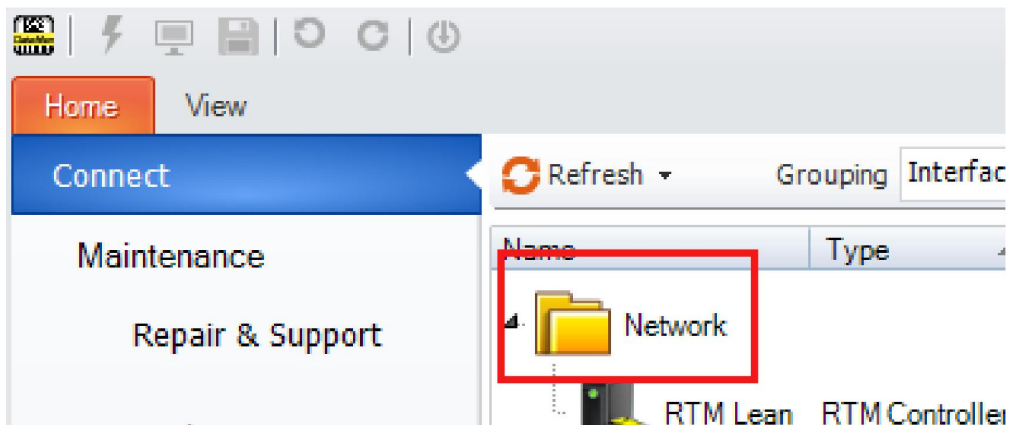

If the reader does not appear in the list of devices, you can use either the **Add Device** or **Force Network Settings** options in the DataMan Setup Tool under **Repair & Support**. For more information, see the *DataMan Setup Tool Reference Manual*.

5. Select a reader from the list and double click it or click **Connect**.

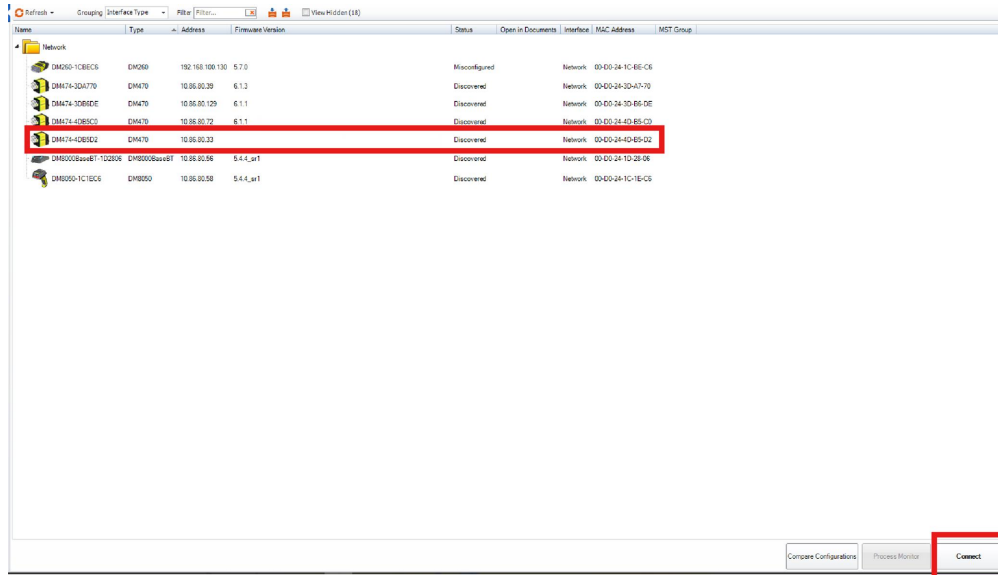

6. Click the **Live** button and position your code under the DataMan 370 Series reader. You can see the live display of the reader in the Image Panel.

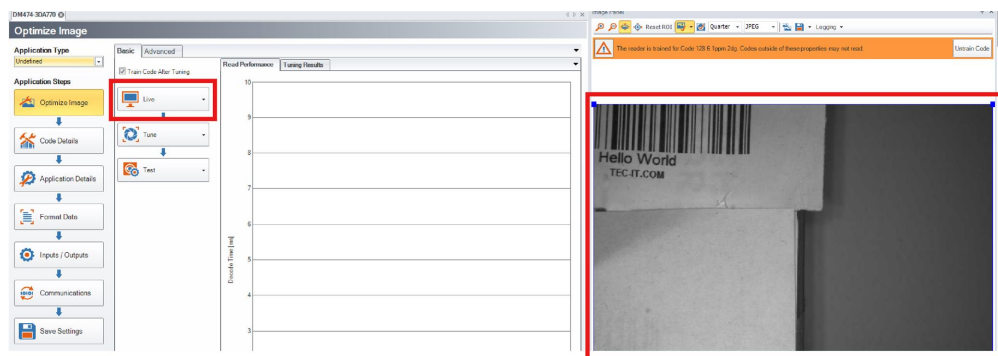

Note: If you are running the DM370 at line speed, you may need to disconnect Setup Tool and obtain results through the device output interface.

7. Click the **Tune** button to have the DataMan 370 Series reader optimize its focus and brightness based on the code and the environment.

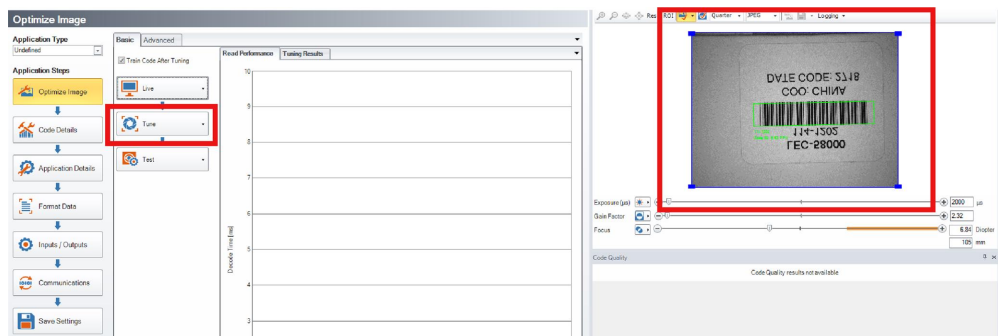

8. Click the **Trigger** button and have the DataMan 370 Series reader acquire image and decode the code. You can see the results of the code in the Result History panel.

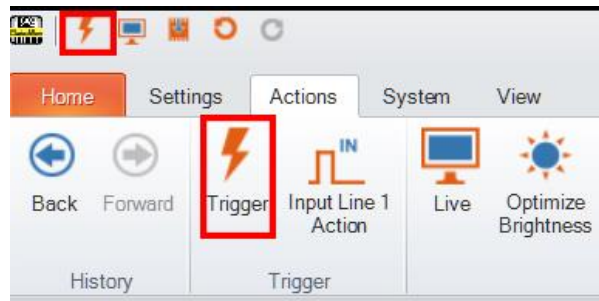

In case you need image enhancement, image filtering might improve the image quality and code readability.

WARNING: Do not stare into the beam when adding, removing, or changing cables. Cognex recommends to disconnect the reader from power whenever you make physical changes to it.

Follow the steps below to connect your reader to power and network:

CAUTION: I/O wiring or adjustments to I/O devices should be performed when the reader is not receiving power.

CAUTION: The Ethernet cable shield must be grounded at the far end. Whatever this cable is plugged into (usually a switch or router) should have a grounded Ethernet connector. A digital voltmeter should be used to validate the grounding. If the far end device is not grounded, a ground wire should be added in compliance with local electrical codes.

1. Connect the I/O+RS232+24V cable to your reader.
2. Connect your reader through an Ethernet cable to your network for a network connection.
3. Connect the cable to a 24V power supply.

DataMan 370 Triggering

DataMan 370 readers support the following trigger modes:

- **Self:** At an interval you configure, the reader automatically detects and decodes codes in its field of view. If you set a higher re-read delay than the trigger interval, there is a code output only once until the code is out of the field of view for the duration of the re-read delay.
- **Single (external trigger):** Acquires a single image and attempts to decode any symbol it contains, or more than one symbol in cases where multicode is enabled. The reader relies on an external trigger source.
- **Presentation:** Scans, decodes and reports a single code in the field of view. The reader relies on an internal timing mechanism to acquire images.
- **Manual:** Begins acquiring images when you press the trigger button on the reader, and continues acquiring images until a symbol is found and decoded or you release the button.
- **Burst:** Performs multiple image acquisitions based on an external trigger and decodes any symbol appearing in a single image or within a sequence of images, or multiple symbols in a single image or within a sequence of images when multicode is enabled. You can control the number of images within each burst and the interval between image acquisitions.
- **Continuous:** Begins acquiring images based on a single external trigger and continues to acquire and decode images until a symbol is found and decoded, or until multiple images containing as many codes as specified in multicode mode are located, or until the trigger is released. You can configure your reader to acquire images based on the start and stop signal from separate digital IO pulses.

In **Single**, **Burst**, **Continuous**, and **Self** trigger modes, it is possible to **synchronize image acquisition** on multiple devices using the synchronization interface. Synchronization allows using one shared strobe illumination to expose all sensors simultaneously. You can synchronize multiple readers with optionally triggering them in a defined sequence to avoid that opposing readers blind each other. Note that this and other imager settings will not get synchronized by this mechanism - for example, you must configure exposure and gain on each reader individually. This feature only synchronizes the actual image acquisition, triggering happens through the existing Multi-Reader Sync mechanism.

To set up synchronized acquisition on DataMan 370, enable PTP (Precision Time Protocol) on the **Multi-Reader Sync** pane of the DataMan Setup Tool under Synchronized Readers (IE1588). Set the Secondary Reader Only accordingly on each reader individually to define **Multi-Reader Sync** reader relations.

The setting in 7 steps:

1. Check the Enable PTP check box.
2. Keep set the Secondary Reader Only check box if there is already a PTP master clock in the net (uncheck otherwise on at least one reader)
3. Tune fine by Priority 1 and Priority 2
4. Enable Multi-Reader Sync by trigger: Use PTP to actually sync Multi-Reader Sync triggering
5. Time between Trigger Start and the Synchronized Acquisition Timestamp: Time the Primary Reader adds to the trigger to make sure all devices already received the trigger message before this time stamp.
6. Local Offset Added to the Synchronized Acquisition Timestamp: Time the Secondary Reader adds to the timestamp to realize offset image acquisitions.

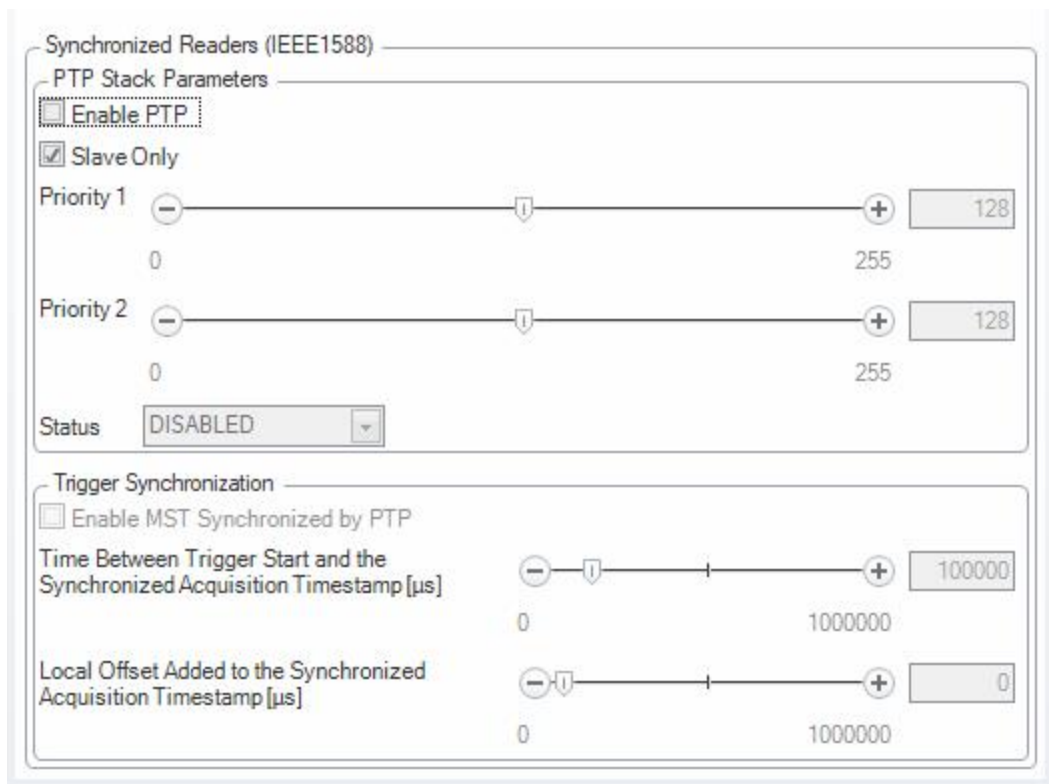

External Triggers

If you are using external triggering, you can use any of the following methods to trigger your DataMan 370 reader:

- Press the trigger button on the reader.
- Send a pulse on the I/O cable:
 - Trigger + (orange or red)
 - Trigger - (black)
- Send a serial trigger command over the RS-232 connection connection.
- Press <CTRL-T> on the keyboard while the DataMan Setup Tool has the input focus.
- Click the **Trigger** button in the DataMan Setup Tool:

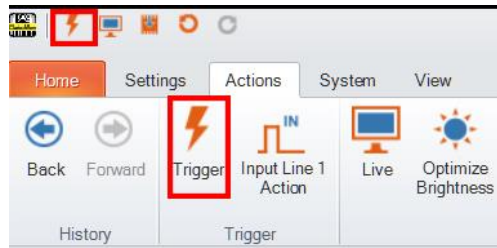

Training the Reader

Training your reader with the expected symbology can make the time required to decode successive symbols more consistent. In addition, training may help increase decode yield.

To train your reader, place a code in front of the reader and do one of the following:

- Press and hold the trigger button for a minimum of 3 seconds.
- Click and hold the trigger button in the DataMan Setup Tool for a minimum of 3 seconds.



- Click **Train Code** under **Actions** on the ribbon bar.

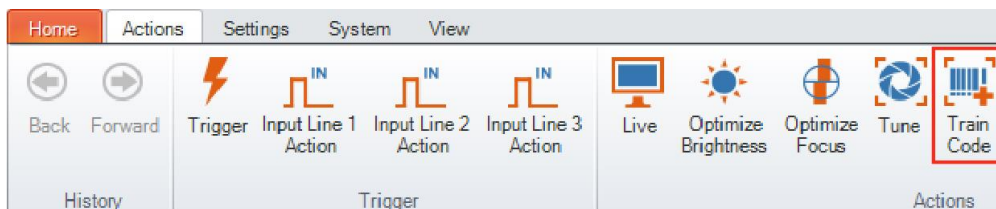

You can use training in **Single**, **Burst**, **Continuous** or **Self** trigger modes.

Note: Only a single symbol of each symbology kind can be trained.

Training Feedback

The second LED from left on the reader glows green to indicate that it is currently trained, or yellow to indicate that it is not trained.

Connect the reader to the DataMan Setup Tool to untrain it and allow it to recognize other enabled symbologies.

Incremental Training for Multiple Symbologies

If you want to train the reader to recognize multiple symbologies, you can present a single image showing all the desired symbologies and perform the training procedure previously described.

If you cannot present a single image showing all the necessary symbologies, you can enable incremental training under **Training** on the **Advanced** tab of the **Code Details** pane:

The screenshot shows the 'Code Details' pane with the 'Advanced' tab selected. The 'Training' section is expanded, and the 'Incremental Training' checkbox is checked and highlighted with a red box. Other settings visible include 'Number of Codes' set to 1, 'Allow Partial Results' unchecked, and 'Sorting Priority' set to 'Symbology'.

With incremental training enabled, you can train the reader using multiple images showing the symbologies you expect to decode. The reader will train each new symbology while retaining the existing trained symbologies.

Industrial Protocols

The DataMan 370 readers support the following industrial protocols:

- EtherNet/IP™
- PROFINET
- SLMP Protocol
- Modbus TCP

Select industrial protocol samples and tools you want to use when you install the DataMan Setup Tool.

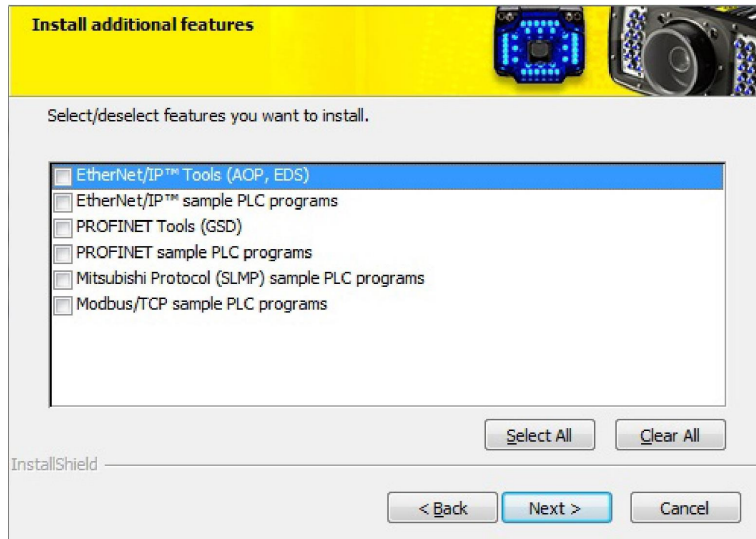

There are three ways to enable or disable industrial protocols. Using either method, a reboot is required for the changes to come into effect.

- Enable the protocols using the **Industrial Protocols** pane of the DataManSetup Tool (under **Communications**).
- Scan the appropriate **Reader Configuration codes** (see *Reader Configuration Codes* available through the Windows **Start** menu or the Setup Tool **Help** menu).
- Send the appropriate **DMCC** (see *Command Reference* available through the Windows **Start** menu or the Setup Tool **Help** menu).

For more information on using the industrial protocols, see the *DataMan Industrial Protocols Manual* available through the Windows **Start** menu or the Setup Tool **Help** menu.

Advanced Features

DataMan 370 Series Image Filtering

You can define a stack of filters to be applied to each image acquired by your DataMan 370 series reader. To select the following filters in DataMan Setup Tool, click the **Optimize Image** pane, select the **Advanced** tab, click the triangle next to **Image filtering**, click "..." next to No Filtering for more options, then click the **Add** button.

- *Equalize*
This filter redistributes the brightness values of the pixels in the image. As a result, the range of brightness levels are more evenly represented. Use this filter if you have too dark or too bright images.
- *Stretch*
This filter linearly scales up or stretches the greyscale values in the input image to the full 256-step greyscale. The result is an output image with increased contrast.
- *Low Pass*
Using this filter results in output images where edges are smoothed or blurred.
- *Dilate*
This filter increases bright features and shrinks dark features. The result is an output image with larger areas of bright pixels. Use this filter to remove dark specks.
- *Erode*
This filter shrinks bright features and increases dark features. The result is an output image with larger areas of dark pixels. Use this filter to remove light specks.
- *Open*
This filter performs an erosion followed by a dilation to filter out bright features that are smaller than the size of the processing neighborhood. The result is an output image with slightly decreased overall brightness.
- *Close*
This filter performs a dilation followed by an erosion to filter out dark features that are smaller than the size of the processing neighborhood. The result is an output image with slightly increased overall brightness.
- *Auto Stretch*
This filter reduces the pixel value range. It maps the pixel values from 0 to 255.
- *Optical Density*
This filter specifies an inversion of pixel values based on a logarithmic scale. The result is an output image that reveals the density of objects and features in the input image by measuring the amount of light that passes through them. Denser objects and features are represented by lighter pixels in the output image.
- *Invert*
This filter specifies an inversion of pixel values based on the 256-step greyscale. The result is an output image that is a "negative" of the input image.

To use Image Filtering, perform the following steps:

1. On the Image Filtering pane, click **Add**.
2. Select a filter from the **Filter Properties** drop-down box. You can add more than one filter. You can also specify the order in which filtering is done by moving the filters using the **Up** and **Down** buttons.
3. If the filter you selected require further settings, change properties according to your needs.
4. Change the selection in the **Image to Use** group box according to the symbology you want to be filtered (after making sure that that Symbology is enabled):

If no image is read, the Results Display shows the image according to your selection under No-Read Image.

5. Go to the Displayed Image Settings pane and change the Images to Use according to what you want to see on Live Display: the original or the filtered image.
6. You can compare the original and filtered results on the Results Display if you choose the images from the Read Result History.
The example images were taken using the Equalize filter.

Package Detection Support

You can connect your package detection sensor to one of the digital inputs of your DataMan reader. When the reader receives a signal that a package is detected, images that the reader collected are not discarded at the end of the trigger. This way you can make sure that there was a package there, only the code was not readable. Looking at the No Read images will help you find out why there were no decode results.

Package detection is only supported with Continuous trigger mode.

To make sure that the No Read images are collected, perform the following:

1. Connect your package detection device to one of the Inputs of your reader.
2. On the **Inputs/Outputs** pane, check **Allow Buffered No-Read Images** on the input you connected your reader to.
3. On the **Inputs/Outputs** pane, click **Buffering and Transfer**, and in the **Image Buffering** pane, change **What Results to Buffer** under Buffering Settings to All, or No Read.
 - In the case of **All**, good reads are also saved together with No Reads.
 - In the case of **No Read**, the image is buffered if the reader fails to read.

For more information, see the *DataMan Fixed-Mount Readers Reference*, available through the Windows **Start** menu or the DataMan Setup Tool **Help** menu.

DataMan 370 Series Multi-Reader Sync Option

For trigger modes other than **Presentation**, the DataMan 370 supports multi-reader trigger synchronization, also known as Multi-Reader Sync. In this option, you configure multiple DataMan readers as a group. Whenever any reader in the group is triggered, all the readers are triggered and the results from all the readers are assembled and transmitted by a single reader that you designate as the Primary Reader.

Multi-Reader Sync is used to support extended field of view reading and reading codes from multiple product surfaces:

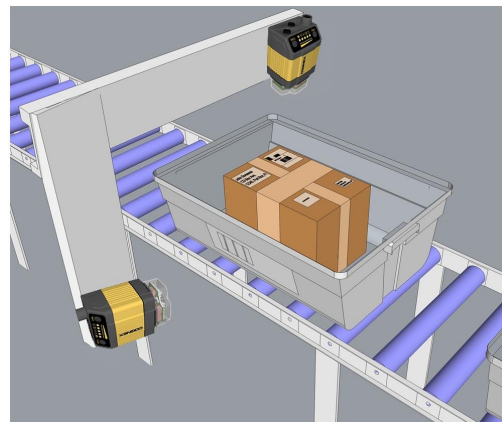
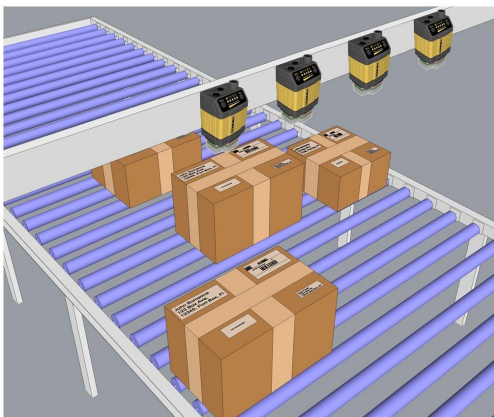

To configure Multi-Reader Sync, go to the group editor in the DataMan Setup Tool. For more information, see the *Setup Tool Reference Manual*.

In **Single**, **Burst**, **Continuous**, and **Self** trigger modes, it is possible to **synchronize image acquisition** on multiple devices using the synchronization interface. Synchronization allows using one shared strobe illumination to expose all sensors simultaneously. You can synchronize multiple readers, with optionally triggering them in a defined sequence to avoid that opposing readers blind each other. Note that this and other imager settings will not get synchronized by this mechanism - for example, you must configure exposure and gain on each reader individually. This feature only synchronizes the actual image acquisition. Triggering happens through the existing Multi-Reader Sync mechanism.

To set up synchronized acquisition on DataMan 370, enable PTP (Precision Time Protocol) on the Multi-Reader Sync pane of the DataMan Setup Tool under Synchronized Readers (IE1588).

Perform the following steps:

1. Check **Enable PTP**.
2. Keep **Secondary Camera Only** checked if there is already a PTP Primary Reader clock in the network (uncheck the checkbox otherwise on at least one reader).
3. Enable **MRS Synchronized by PTP** to synchronize Multi-Reader Sync triggering.
4. Set the **Time between Trigger Start and the Synchronized Acquisition Timestamp**. This is the time the Primary Reader adds to the trigger to make sure all devices already received the trigger message before this time stamp (Primary Reader Only).
5. Set the **Local Offset Added to the Synchronized Acquisition Timestamp**. This is the time the Secondary Reader adds to the timestamp to realize offset image acquisitions (Secondary Reader Only).

Note: The DataMan 370 readers use IEEE1588 for high-speed trigger synchronization.

Note: Multi-Reader Sync is only available in DataMan 370 readers with an -M option. For details, see [DataMan 370 Systems on page 15](#).

Connections, Optics, and Lighting

This section contains descriptions about the external light control, I/O Cables, high-speed outputs, high-speed output wiring, Ethernet M12 to RJ45 cable, and acquisition trigger.

External Light Control (CCB-M12XFLY-05)

A 4-pin cable is provided for the external light control. The External Light cable is used to connect to an external lighting device, providing power and strobe control.

The drawing on the left shows the socket on the device.

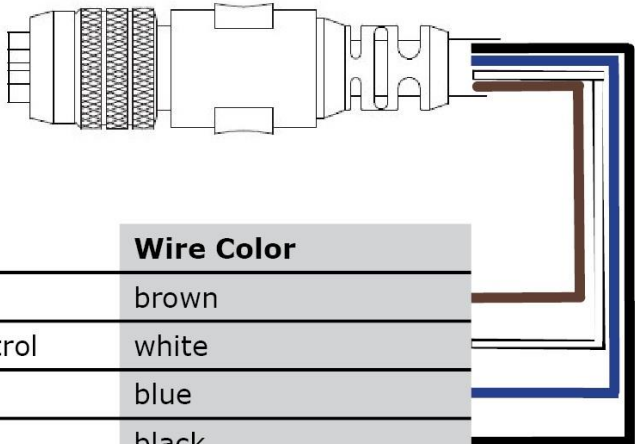
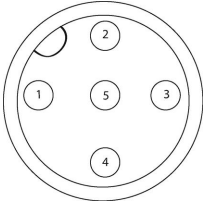

Pin #	Signal Name	Wire Color
1	+24 VDC	brown
2	Brightness Control	white
3	GND	blue
4	Strobe	black
5	Chassis	not connected

Output Voltage	24 V+/-5% (20 V – 27 V) Voltage may drop depending on the length of the cable.	
	Max avg Current	1 A
	Peak Operating Current	1.5 A up to 100 μs, avg to not exceed 1 A
	Max Inrush Current	5 A not exceeding 0.4 As

5 m Breakout Cable (CCBL-05-01)

The Breakout cable provides access to trigger and high-speed outputs. You can clip unused wires short or use a tie made of non-conductive material to tie them back. For RS-232, use the Power Supply return path for ground.

The figure on the left shows the plug on the device.

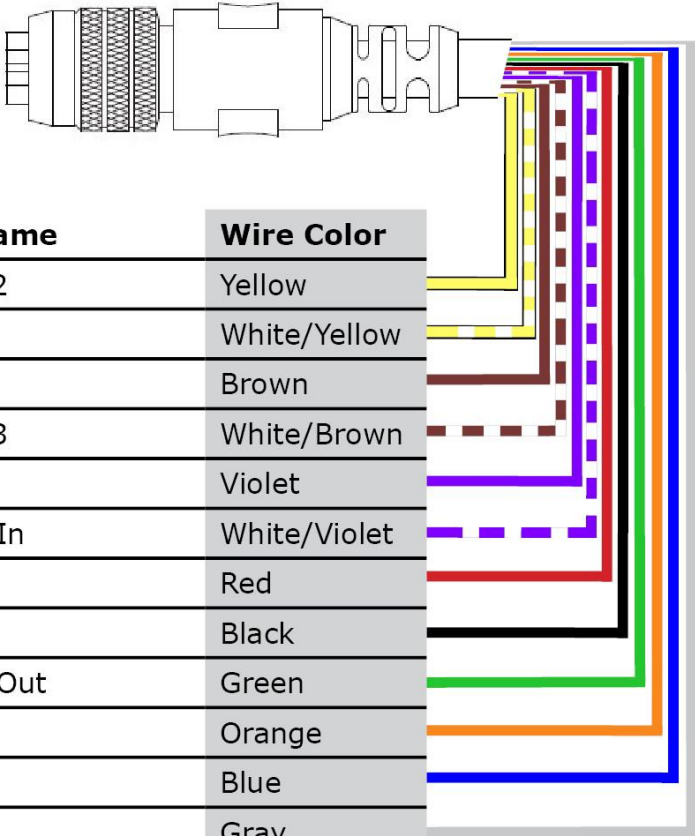

Pin #	Signal Name	Wire Color
1	Out 2/In 2	Yellow
2	TxD	White/Yellow
3	RxD	Brown
4	Out 3/In 3	White/Brown
5	In 1	Violet
6	Common In	White/Violet
7	+24 VDC	Red
8	GND	Black
9	Common Out	Green
10	In 0	Orange
11	Out 0	Blue
12	Out 1	Gray

5m Breakout Cable (CCB-M12x12Fy-xx)

The Breakout cable provides access to trigger and high-speed outputs. You can clip unused wires short or use a tie made of non-conductive material to tie them back.

The figure on the left shows the plug on the device.

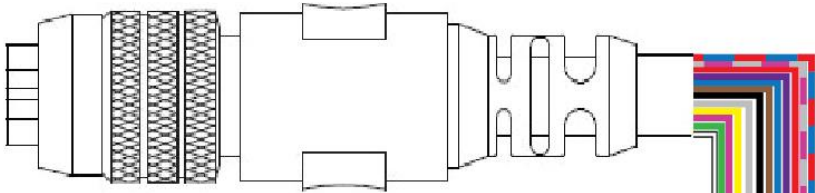

Pin #	Signal Name	Wire Color
1	Out 2/In 2	White
2	TxD	Green
3	RxD	Pink
4	Out 3/In 3	Yellow
5	In 1	Grey
6	Common In	Black
7	+24 VDC	Brown
8	GND	Blue
9	Common Out	Purple
10	In 0	Red
11	Out 0	Grey/Pink
12	Out 1	Red/Blue

15m Breakout Cable (CCB-PWRIO-XX)

The Breakout cable provides access to trigger and high-speed outputs. You can clip unused wires short or use a tie made of non-conductive material to tie them back. For RS-232, use the Power Supply return path for ground.

The figure on the left shows the plug on the device.

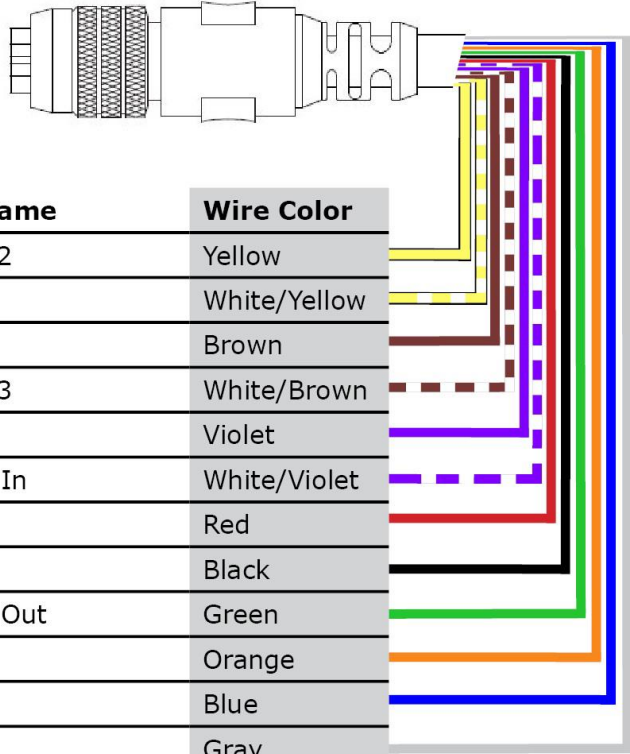

Acquisition Trigger

To trigger from an NPN type photoelectric sensor or PLC output, connect **Common In** to +24V and connect to the output of the photoelectric sensor. When the output turns on, it pulls down to 0V, turning the opto-coupler on.

To trigger from a PNP photoelectric sensor or PLC output, connect to the output of the photoelectric sensor and connect **Common In** to 0V. When the output turns on, it pulls up to +24V, turning the opto-coupler ON.

High-Speed Outputs

Specification	Description
Voltage	26.4 V maximum through external load
Current	50 mA maximum sink current
	OFF state leakage current 100 μ A
	External load resistance 240 Ohms to 10K Ohms
	Each line rated at a maximum 50 mA, protected against over-current, short circuits and transients from switching inductive loads. High-current inductive loads require external protection diode.

For NPN lines, the external load should be connected between the output and the positive supply voltage (<26.4V). The outputs pull down to less than 3V when ON, which causes current to flow through the load. When the outputs are OFF, no current flows through the load.

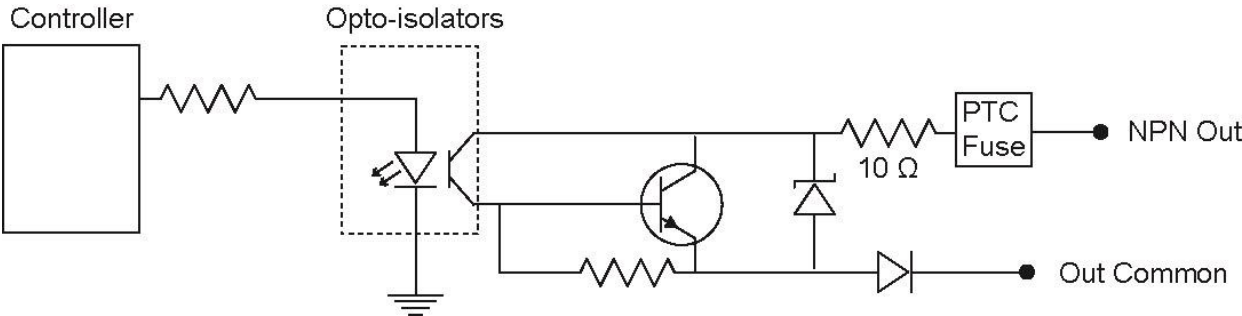

For PNP lines, the external load should be connected between the output and the negative supply voltage (0V). When connected to a 24VDC power supply, the outputs pull up greater than 21V when ON, and current flows through the load. When the outputs are OFF, no current flows through the load.

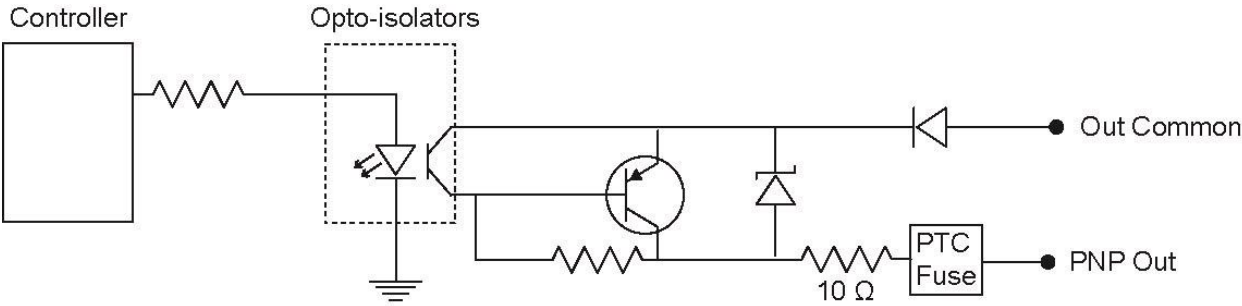

High-Speed Output Wiring

To connect to an NPN-compatible PLC input, connect High-Speed Output 0, Output 1, Output 2, or Output 3 directly to the PLC input. When enabled, the output pulls the PLC input down to less than 3V.

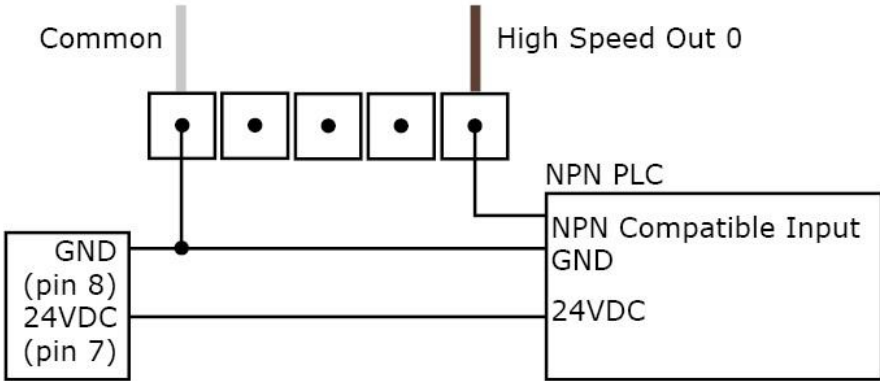

To connect to a PNP-compatible PLC input, connect High-Speed Output 0, Output 1, Output 2 or Output 3 directly to the PLC input. When enabled, the output pulls the PLC input up to greater than 21V.

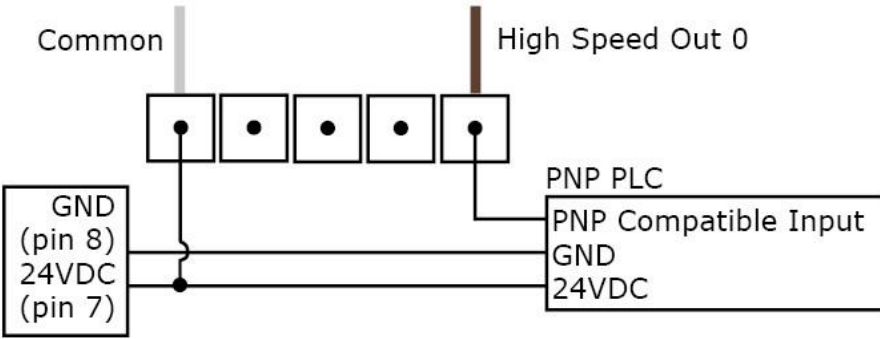

To connect the high-speed outputs to a relay, LED or similar load, connect the negative side of the load to the output and the positive side to +24V. When the output switches on, the negative side of the load is pulled down to less than 3V, and 24V appears across the load. Use a protection diode for a large inductive load, with the anode connected to the output and the cathode connected to +24V.

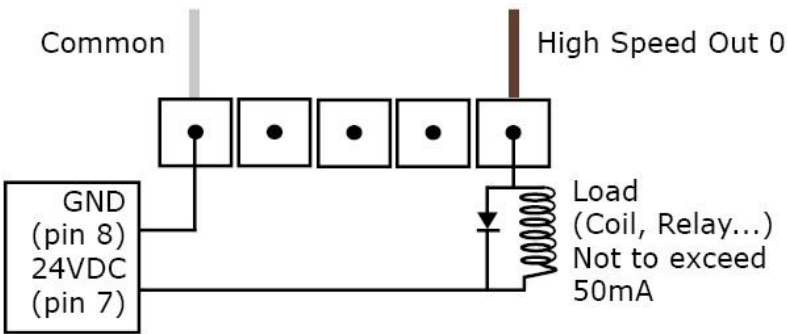

Connecting the Encoder to Your DataMan 370 Reader

The DM370 series readers are configurable to support all encoder modes listed below.

Encoder Mode	Description
Unidirectional	One input counts encoder ticks
Bidirectional	<ul style="list-style-type: none"> • One input counts encoder ticks • Second input for direction information • 2 inputs for quadrature modulated signals

The encoder has four wires. The color coding of the wires is the following:

Wire Color	Signal Name
Red	+24 VDC
Black	common- can be connected to either +24 VDC (NPN) or ground (PNP)
White	the output connected to the input line of the DataMan reader
Bare	ground

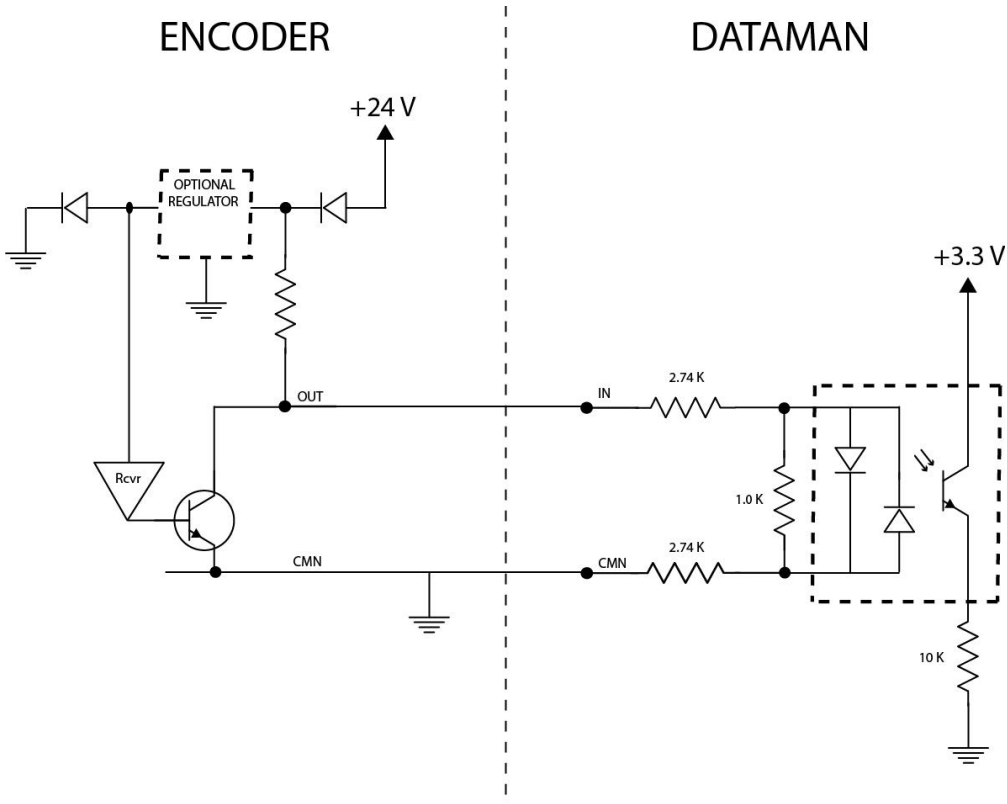

According to the speed of the line, set the number of pulses per revolution on the wheel by using the switches on the encoder (for more information, see the encoder documentation). DataMan 370 and DataMan 470 series readers support pulse frequency up to 50 kHz.

In the DataMan Setup Tool, configure the use of your DataMan reader with the encoder in the Pulse Encoder tab of the **Inputs/Outputs** pane.

5m RS-232 Connection Cable (CCB-M12XDB9Y-05)

You can clip unused wires short or use a tie made of non-conductive material to tie them back.

The figure on the left shows the plug on the device.

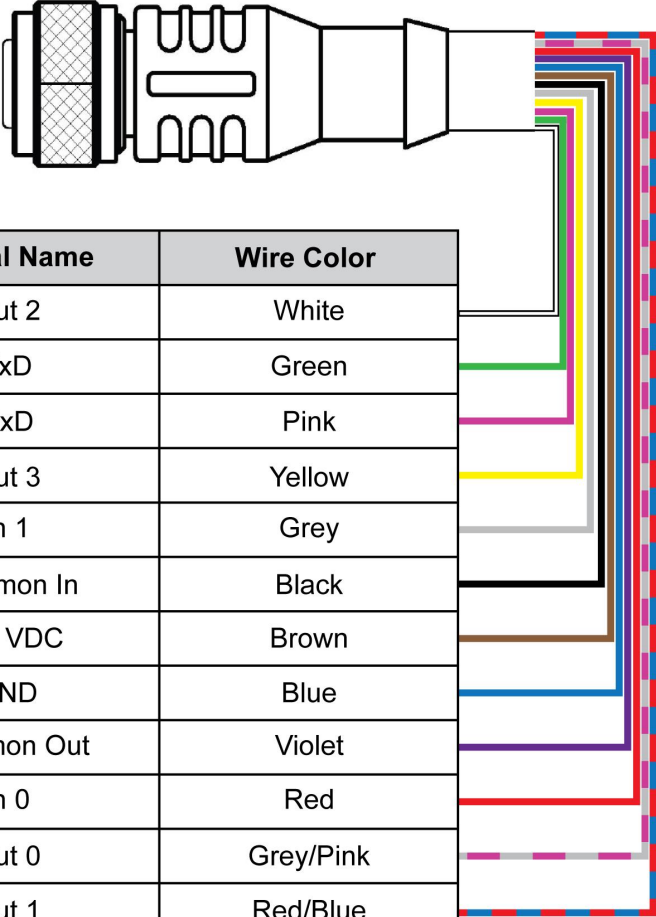

Pin #	Signal Name	Wire Color
1	Out 2	White
2	TxD	Green
3	RxD	Pink
4	Out 3	Yellow
5	In 1	Grey
6	Common In	Black
7	+24 VDC	Brown
8	GND	Blue
9	Common Out	Violet
10	In 0	Red
11	Out 0	Grey/Pink
12	Out 1	Red/Blue

The Ethernet cable provides Ethernet connection for network communications. The Ethernet cable can be connected to a single device or provide connections to multiple devices via a network switch or router.

i Note: Cables are sold separately. The wiring for this cable follows standard industrial Ethernet M12 specifications. This differs from the 568B standard.

Cleaning and Maintenance

Cleaning the Reader Housing

To clean the outside of the reader housing, use a small amount of mild detergent cleaner or isopropyl alcohol on a cleaning cloth. Do not pour the cleaner directly onto the reader housing.

 **CAUTION:** Do not attempt to clean any DataMan product with harsh or corrosive solvents, including lye, methyl ethyl ketone (MEK) or gasoline.

Cleaning the Reader Lens Cover

To remove dust from the lens cover, use a pressurized air duster. The air must be free of oil, moisture or other contaminants that could remain on the lens cover. To clean the plastic window of the lens cover, use a small amount of isopropyl alcohol on a cleaning cloth. Do not scratch the plastic window. Do not pour the alcohol directly on the plastic window.

Compliance Information, Warnings and Notices

Precautions

To reduce the risk of injury or equipment damage, observe the following precautions when you install the Cognex product:

- The reader is intended to be supplied by a UL or NRTL listed power supply with a 24VDC output rated for at least 2A continuous and a maximum short circuit current rating of less than 8A and a maximum power rating of less than 100VA and marked Class 2 or Limited Power Source (LPS). Any other voltage creates a risk of fire or shock and can damage the components. Applicable national and local wiring standards and rules must be followed.
- Route cables and wires away from high-current wiring or high-voltage power sources to reduce the risk of damage or malfunction from the following causes: over-voltage, line noise, electrostatic discharge (ESD), power surges, or other irregularities in the power supply.
- Do not install Cognex products where they are exposed to environmental hazards such as excessive heat, dust, moisture, humidity, impact, vibration, corrosive substances, flammable substances, or static electricity.
- Do not expose the image sensor to laser light. Image sensors can be damaged by direct, or reflected, laser light. If your application requires laser light that might strike the image sensor, use a lens filter at the corresponding laser wavelength. For suggestions, contact your local integrator or application engineer.
- Changes or modifications not expressly approved by the party responsible for regulatory compliance could void the user's authority to operate the equipment.
- Include service loops with cable connections.
- Ensure that the cable bend radius begins at least six inches from the connector. Cable shielding can be degraded or cables can be damaged or wear out faster if a service loop or bend radius is tighter than 10X the cable diameter.
- This device should be used in accordance with the instructions in this manual.
- All specifications are for reference purposes only and can change without notice.

Regulations/Conformity

Note: For the most current CE declaration and regulatory conformity information, see the Cognex support site: cognex.com/support.

DataMan 370 Series readers have Regulatory Model R00051 and meet or exceed the requirements of all applicable standards organizations for safe operation. However, as with any electrical equipment, the best way to ensure safe operation is to operate them according to the agency guidelines that follow. Please read these guidelines carefully before using your device.

Safety and Regulatory	
Manufacturer	Cognex Corporation One Vision Drive Natick, MA 01760 USA
USA	TÜV SÜD SCC/NRTL OSHA Scheme for UL/CAN 61010-1. FCC Part 15, Class A This equipment has been tested and found to comply with the limits for a Class A digital device, pursuant to part 15 of the FCC Rules. These limits are designed to provide reasonable protection against harmful interference when the equipment is operated in a commercial environment. This equipment generates, uses, and can radiate radio frequency energy and, if not installed and used in accordance with the instruction manual, may cause harmful interference to radio communications. Operation of this equipment in a residential area is likely to cause harmful interference in which case the user will be required to correct the interference at his own expense.
Canada	TÜV SÜD SCC/NRTL OSHA Scheme for UL/CAN 61010-1. ICES-003, Class A This Class A digital apparatus complies with Canadian ICES-003. Cet appareil numérique de la classe A est conforme à la norme NMB-003 du Canada.
Europe	The CE mark on the product indicates that the system has been tested to and conforms to the provisions noted within the 2014/30/EU Electromagnetic Compatibility Directive and the 2011/65/EU RoHS Directive. For further information, please contact: Cognex Corporation, One Vision Drive, Natick, MA 01760, USA. Cognex Corporation shall not be liable for use of our product with equipment (i.e., power supplies, personal computers, etc.) that is not CE.
Australia	Radiocommunications (Electromagnetic Compatibility) Standard: 2017 (EN 61326-1:2013) 
Korea	A급 기기(업무용 방송통신기자재): 이 기기는 업무용(A급) 전자파적합기기로서 판매자 또는 사용자는 이 점을 주의하시기 바라 며, 가정외의 지역에서 사용하는 것을 목적으로 합니다.
International Product Safety	Conforms to IEC 61010-1, CAN/CSA-C22.2 No. 61010-1:2012 + UPD No. 1:2015-07, UL 61010-1:2012 + R:2015-07, UL 61010-1:2012 + R:2015-07, EN 61010-1:2010.
CB	TÜV SÜD, IEC/EN 61010-1. CB report available upon request.

For European Community Users

Cognex complies with Directive 2012/19/EU OF THE EUROPEAN PARLIAMENT AND OF THE COUNCIL of 4 July 2012 on waste electrical and electronic equipment (WEEE).

This product has required the extraction and use of natural resources for its production. It may contain hazardous substances that could impact health and the environment, if not properly disposed.

In order to avoid the dissemination of those substances in our environment and to diminish the pressure on the natural resources, we encourage you to use the appropriate take-back systems for product disposal. Those systems will reuse or recycle most of the materials of the product you are disposing in a sound way.



The crossed out wheeled bin symbol informs you that the product should not be disposed of along with municipal waste and invites you to use the appropriate separate take-back systems for product disposal.

If you need more information on the collection, reuse, and recycling systems, please contact your local or regional waste administration.

You may also contact your supplier for more information on the environmental performance of this product.

Reader Programming Codes



Reset Scanner to Factory Defaults



Reboot Scanner

