

DataMan[®] 475 Verifier Reference Manual

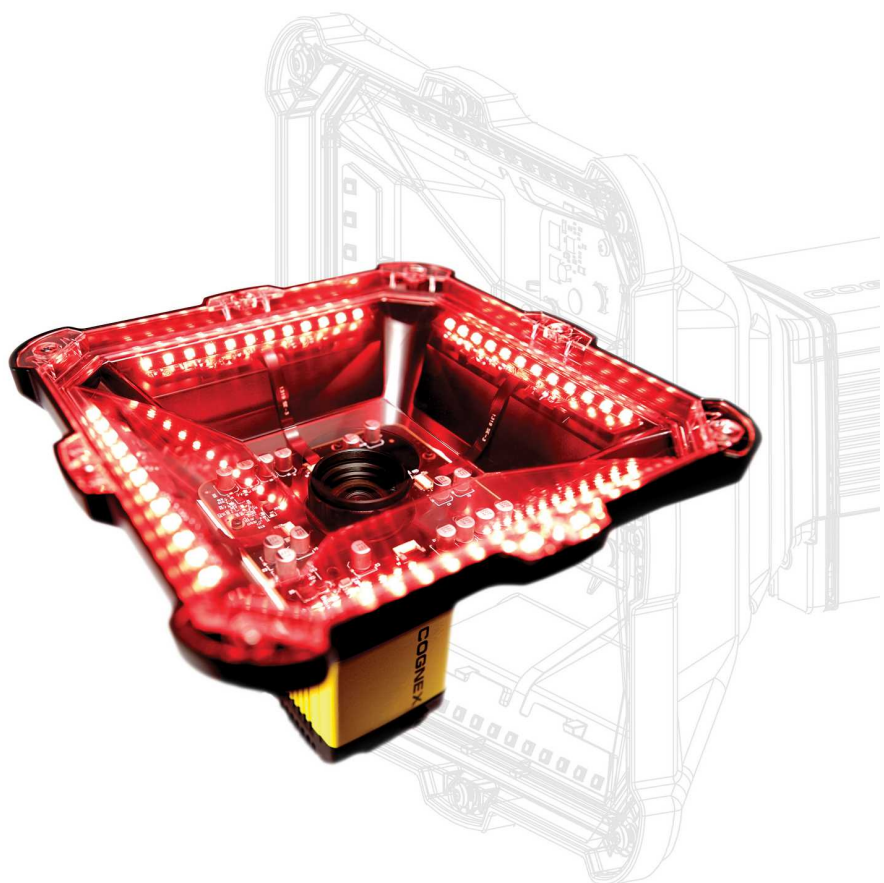

2021 May 26

Revision: 6.1.10-SR1.4

Legal Notices

The software described in this document is furnished under license, and may be used or copied only in accordance with the terms of such license and with the inclusion of the copyright notice shown on this page. Neither the software, this document, nor any copies thereof may be provided to, or otherwise made available to, anyone other than the licensee. Title to, and ownership of, this software remains with Cognex Corporation or its licensor. Cognex Corporation assumes no responsibility for the use or reliability of its software on equipment that is not supplied by Cognex Corporation. Cognex Corporation makes no warranties, either express or implied, regarding the described software, its merchantability, non-infringement or its fitness for any particular purpose.

The information in this document is subject to change without notice and should not be construed as a commitment by Cognex Corporation. Cognex Corporation is not responsible for any errors that may be present in either this document or the associated software.

Companies, names, and data used in examples herein are fictitious unless otherwise noted. No part of this document may be reproduced or transmitted in any form or by any means, electronic or mechanical, for any purpose, nor transferred to any other media or language without the written permission of Cognex Corporation.

Copyright © 2021. Cognex Corporation. All Rights Reserved.

Portions of the hardware and software provided by Cognex may be covered by one or more U.S. and foreign patents, as well as pending U.S. and foreign patents listed on the Cognex web site at: cognex.com/patents.

The following are registered trademarks of Cognex Corporation:

Cognex, 2DMAX, Advantage, AlignPlus, Assemblyplus, Check it with Checker, Checker, Cognex Vision for Industry, Cognex VSOC, CVL, DataMan, DisplayInspect, DVT, EasyBuilder, Hotbars, IDMax, In-Sight, Laser Killer, MVS-8000, OmniView, PatFind, PatFlex, PatInspect, PatMax, PatQuick, SensorView, SmartView, SmartAdvisor, SmartLearn, UltraLight, Vision Solutions, VisionPro, VisionView

The following are trademarks of Cognex Corporation:

The Cognex logo, 1DMax, 3D-Locate, 3DMax, BGAll, CheckPoint, Cognex VSoC, CVC-1000, FFD, iLearn, In-Sight (design insignia with cross-hairs), In-Sight 2000, InspectEdge, Inspection Designer, MVS, NotchMax, OCRMax, PatMax RedLine, ProofRead, SmartSync, ProfilePlus, SmartDisplay, SmartSystem, SMD4, VisiFlex, Xpand

Portions copyright © Microsoft Corporation. All rights reserved.

Portions copyright © MadCap Software, Inc. All rights reserved.

Other product and company trademarks identified herein are the trademarks of their respective owners.

Table of Contents

Legal Notices	2
Table of Contents	3
Symbols	5
Getting Started	6
About the DataMan 475 Verifier	6
Supporting Documentation	6
DataMan 475 Verifier Accessories	7
Cables and Power Supply	7
Mounting Brackets	8
DataMan 475 Verifier Systems	8
Setting Up Your DataMan 475 Verifier	9
Reader Layout	9
Dimensions	11
DataMan 475 Verifier	11
Additional Information	11
DataMan 475 Verifier Specifications	11
DataMan 475 Series Verifier Imager Specifications	12
LED Wavelengths	13
Calibration	14
User Interface	18
Toolbar	18
Using Your DataMan 475 Verifier	19
Verifying a 2D Barcode	19
Selecting Regions	20
Standards Based Grading	21
Verifications of Multiple Symbols	21
Examining the Results	23
1D & 2D Verification	23
Main Tab	23
General Characteristics Tab	24
Data Detail Tab	25
Modulation table legend	27
Quality Detail Tab	27
Advanced Detail Tab	28
Histogram Tab	29
Report Tab	30
Settings	31
The Settings Menu	31
Application Settings	31
Application Standards Settings	31
Grading Standards	37
Data Format Check	38

Auto Aperture	39
Calibration Settings	40
Trending Settings	41
User Information	42
Report Settings	42
Navigation	43
Results through Setup Tool (local machine)	44
Results through FTP	44
Symbologies/Multi Mode	46
Scripting	46
Setting Up FTP Transfer	48
Image FTP Transfer	48
Result FTP Transfer	48
Report FTP Transfer	49
Grading Standards and their Parameters	50
ISO/IEC 15415 Grading Parameters	50
ISO 18004 QR Code Grading Parameters	55
ISO 29158 (AIM-DPM) 2006 Grading Parameters	55
Traditional (Non-Graded) Parameters	56
PCS	56
MRD	57
ISO/IEC 15416 (ANSI x3.182) Grading Parameters	57
Setting Up DataMan Setup Tool	60
Reading your first Code	60
External Triggers	62
Cleaning and Maintenance	63
Cleaning the Verifier Housing	63
Cleaning the Verifier Lens Cover	63
Compliance Information, Warnings and Notices	64
Precautions	64
Regulations/Conformity	65
For European Community Users	65

Symbols

The following symbols indicate safety precautions and supplemental information:

 **WARNING:** This symbol indicates a hazard that could cause death, serious personal injury or electrical shock.

 **CAUTION:** This symbol indicates a hazard that could result in property damage.

 **Note:** This symbol indicates additional information about a subject.

 **Tip:** This symbol indicates suggestions and shortcuts that might not otherwise be apparent.

Getting Started

This section provides general information about the DataMan 475 Verifier and the DataMan 475 Verifier accessories and systems.

About the DataMan 475 Verifier



The DataMan 475 Verifier provides immediate quality assurance benefits:

- Sets alerts for when code quality begins to degrade
- Grades up to 20 codes per second
- Exports verification results to PLC, database, or FTP server as CSV, HTML, PDF, and custom formats
- Improves processes with detailed analysis and diagnostic information for every code

The DataMan 475 four-quadrant, 45-degree lighting attachment is compliant with the International Organization for Standardization (ISO) requirements for grading 1D and 2D label-based barcodes. The included calibration card and robust grading algorithms ensure that the DataMan 475 conforms to ISO and application standards while providing accurate and repeatable results.

The DataMan 475 verifiers are packaged in a rugged, IP65-rated housing, and provide numerous ease-of-use features, including one button to trigger and one button to start tuning.

Supporting Documentation

This document provides basic information about how to configure and use the DataMan 475 verifier. Additional information is available through the Windows **Start** menu or the DataMan Setup Tool **Help** menu once installing the DataMan software on your PC:

- The **DataMan Communications and Programming Guide** shows you how to integrate your DataMan verifier into your particular automation and factory environment.

Cognex->DataMan Software v x.x.x->Documentation->Communications->DataMan Communications and Programming Guide

- The **DataMan Industrial Protocols Manual** provides information on how to integrate DataMan verifier into your particular environment using industrial protocols.

Cognex->DataMan Software v x.x.x->Documentation->Communications->DataMan Industrial Protocols Manual

- The **DataMan Reader Configuration Codes** document provides printable 2-D codes that you can use to configure the DataMan verifier.
Cognex->DataMan Software v x.x.x->Documentation->English->Reader Configuration Codes
- The **DataMan 475 Verifier Quick Reference Guide** provides essential information about the DataMan 475 verifier.
Cognex->DataMan Software v x.x.x->Documentation->English->DM475V Series->DM475V Quick Reference Guide
- The **DataMan Fixed-Mount Readers Reference** is a complete online hardware reference for the DataMan fixed-mount ID verifier.
Cognex->DataMan Software v x.x.x->Documentation->English->DM475V ->Fixed-Mount Reference Manual
- The **DataMan Control Commands** lists DataMan Control Commands with all relevant information. You can view this help inside the Setup Tool or as a stand-alone help file.
Cognex->DataMan Software v x.x.x->Documentation->English->DataMan Control Commands
- The **Setup Tool Reference Manual** describes the user interface of the DataMan Setup Tool software.
Cognex->DataMan Software v x.x.x->Documentation->English->Setup Tool Reference Manual
- The **Release Notes** list detailed system requirements and additional information about this DataMan software release.
Cognex->DataMan Software v x.x.x->Documentation->DataMan v x.x.x Release Notes

DataMan 475 Verifier Accessories



Note: For ISO compliant verification, equip the DM475V with LabelLight 45° lighting accessory (DMV-475V-LBL-0200). Use other light accessories for DM475V for Standards Based Grading only.



Note: The product images below serve illustration purposes only. You can purchase the following components separately. For a list of options and accessories, contact your local Cognex sales representative.

Cables and Power Supply



Note: Cables are sold separately.

CAUTION: All cable connectors are keyed to fit the connectors on the verifier. Do not force the connections or damage may occur.

Accessory Name	Accessory Product Number	Accessory Illustration
Power and I/O Breakout Cable, M12-12 to Flying Lead	CCB-PWRIO- xx (straight, xx specifies length: 5m, 10m, 15m) CCB-PWRIO-xxR (right-angled, xx specifies length: 5m, 10m, 15m)	
X-Coded to A-Coded Ethernet cable adapter, 0.5 m	CCB-M12X8MS-XCAC	
Ethernet Cable, X-coded M12-8 to RJ-45	CCB-84901-2001-xx (straight, xx specifies length: 2m, 5m, 10m, 15m, 30m)	

Accessory Name	Accessory Product Number	Accessory Illustration
I/O extension cable, straight, 5 m	CKR-200-CBL-EXT	
Connection module (up to 4 cameras including network switch) xx can be US, EU, UK or JP	DMA-CCM-4X-xx	
Connection module (1 camera) xx can be US, EU, UK or JP	DMA-CCM-1-xx	

Mounting Brackets

Accessory Name	Accessory Product Number	Accessory Illustration
Mounting Bracket Kit	DMBK-470-MNT	
Pivot Mounting Bracket	DM100-PIVOTM-00	
External Heat Sink	DMHS-370-470	

DataMan 475 Verifier Systems

	Symbologies	Light Configurations	Verification Standards
DMV-475V-LBL-0200	1D, 2D, DPM	45° LabelLight	ISO/IEC 15415, 15416, 29158

Setting Up Your DataMan 475 Verifier

This section provides information on the physical appearance of the DataMan 475 verifier. It also details the steps of installing the lenses and filters of the verifier, and gives information on the imager.

Reader Layout

The following image shows the lighting system of the DataMan 475 verifier and the mounting holes underneath the plastic lighting cover.

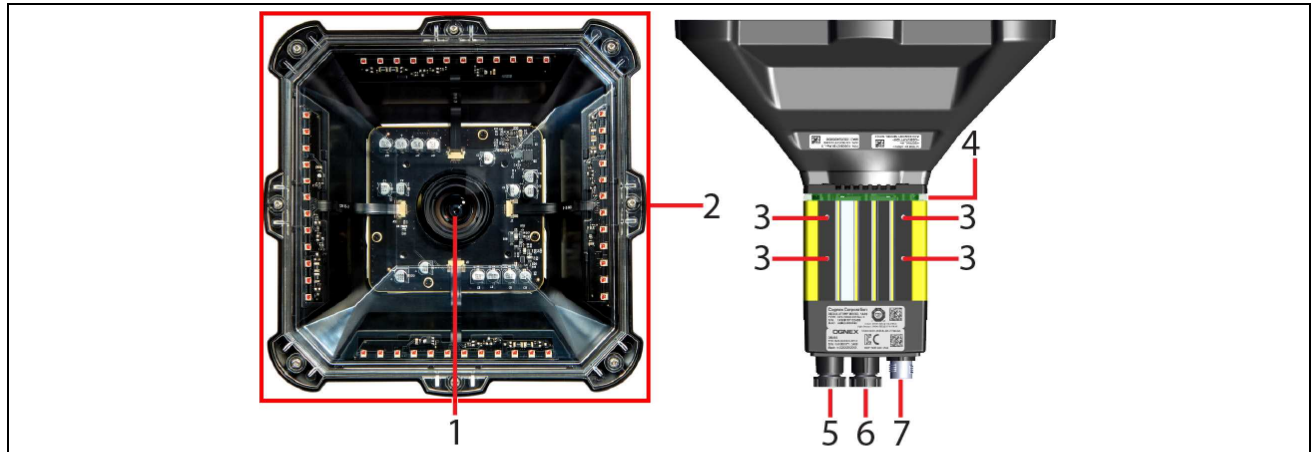

Item	Description
1	Lens
2	Label Light attachment
3	Mounting holes (M3 x 5 mm)
4	Indicator light ring
5	Ethernet connection
6	External lighting connection (disabled for verification)
7	Breakout cable connection

The image shows the back cover of the DataMan 475 and the functions of the indicator lights.

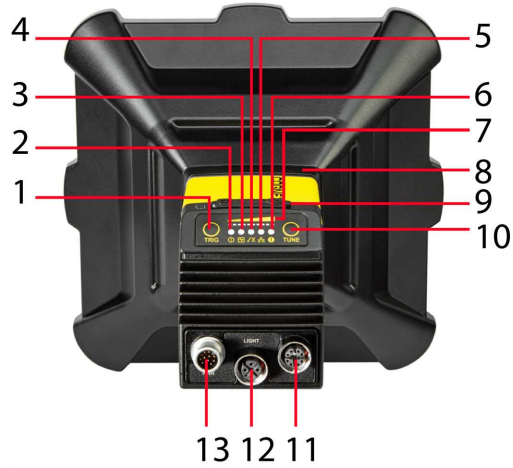

Item	Description
1	Trigger button
2	Power
3	Train status
4	Good/bad read
5	Network
6	Error
7	Peak meter
8	Indicator light ring
9	SD card slot
10	Tuning button
11	Ethernet
12	External light control
13	Power, I/O, and RS-232

The table explains the indicator light ring behavior.

Type	Signal	Color	Meaning
Status	Power	GREEN	Power ON
	Train status	GREEN	Trained
		YELLOW	Untrained
Error	RED	Error - check device log	
Action	Good/bad read	GREEN	Good read
		RED	Bad read
	Communication	YELLOW	Link up
		<i>blink</i>	Activity
	Peak meter	-	Decode yield, train progress/quality

Dimensions

Note:



- Dimensions are in millimeters [inches] and are for reference purposes only.
- All specifications are for reference purposes only and can change without notice.

Observe the following DataMan 475 verifier dimensions when installing your reader.

DataMan 475 Verifier

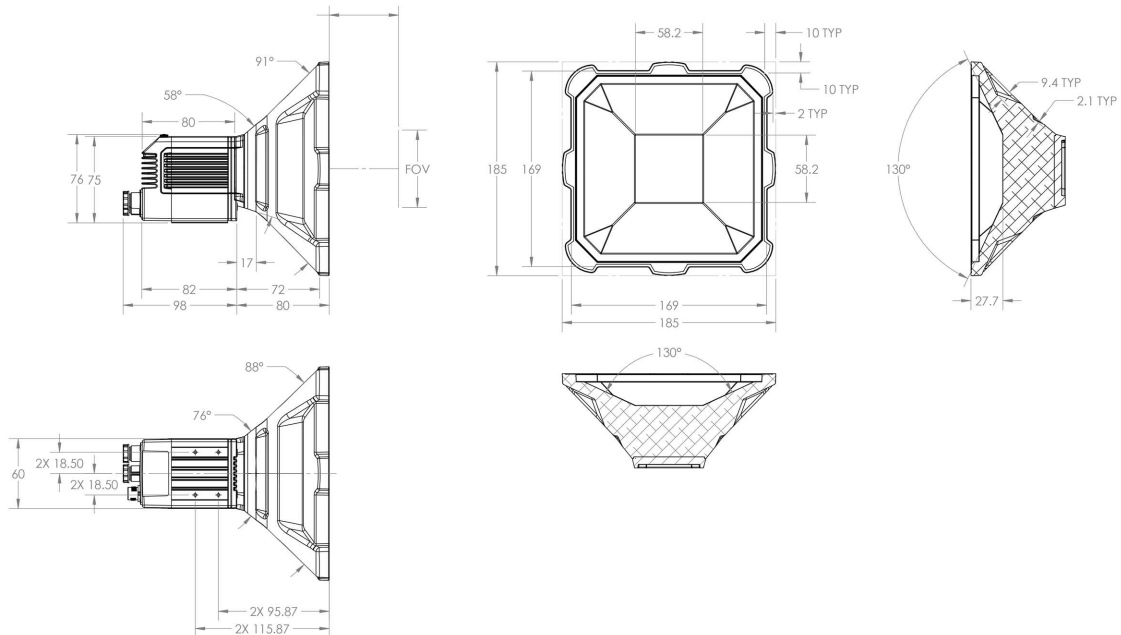

Additional Information

DataMan 475 Verifier Specifications

Specification	DataMan 475 Verifier
Weight	945 g
Field of View	80 x 60 mm
Dimensions	185 x 185 x 175 mm
Power Consumption	<ul style="list-style-type: none"> • 24 VDC ±10%, 1.5 A maximum (Label Light, 36 W peak power consumption) Supplied by LPS or NEC class 2 only.

Specification	DataMan 475 Verifier		
Light Connector	0.4 A		
	Note: The Light Connector is disabled while the Label Light accessory is in place.		
Case Temperature ¹	0°C – 57°C (32°F – 134.6°F)		
Operating Temperature ²	0 °C – 40°C (32 °F – 104°F)		
Storage Temperature	-20°C – 80°C (-4°F – 176°F)		
Humidity	< 95% non-condensing		
Environmental	IP65 with cables attached.		
Shock (Shipping and Storage)	IEC 60068-2-27: 18 shocks (3 shocks in each polarity in each (X, Y, Z) axis) 80 Gs (800 m/s ² at 11 ms, half-sinusoidal) with cables or cable plugs and appropriate lens cover attached.		
Vibration (Shipping and Storage)	IEC 60068-2-6: vibration test in each of the three main axis for 2 hours @ 10 Gs (10 to 500 Hz at 100 m/s ² / 15 mm) with cables or cable plugs and appropriate lens cover attached.		
Supported Symbolologies	1D codes: Codabar, Code 39, Code 128, and Code 93, Interleaved 2 of 5, UPC/EAN/JAN 2D codes: Data Matrix (ECC 200), QR Code, microQR Code Stacked codes: PDF 417		
Discrete I/O operating limits	HS Output 0,1,2,3	I_{MAX}	50 mA
		R_{MIN}	@ 12 VDC 200 Ω
	Input 0 (Trigger)	V_{IH}	±15 — ± 28 V
	Input 1,2,3	V_{IL}	0 — ± 5 V
		I_{TYP}	@ 12 VDC @ 24 VDC 2.0 mA 4.2 mA
Ethernet Speed	10/100/1000		

DataMan 475 Series Verifier Imager Specifications

Specification	DataMan 475 Imager
Image Sensor	2/3 inch CMOS, global shutter
Image Sensor Properties	8.8 mm x 6.6 mm (H x V); 3.45 μm square pixels
Image Resolution (pixels)	2448 x 2048

¹ Additional cooling measures may be required to keep the case temperature from exceeding 50°C. Examples of such measures include: extra heat sinking and/or air movement.

² In situations where the operating temperature exceeds 40 °C, an external heat sink is required.

Specification	DataMan 475 Imager
Electronic Shutter Speed	Minimum exposure: 15 μ s Maximum exposure: 5000 μ s Typically set at 30 μ s by calibration process for ISO 15415. <hr/> ⓘ Note: If the user adjusts the shutter speed, there is no guarantee that the verifier retains compliance.
Image Acquisition at Full Resolution	37 Hz for imager without lighting. <hr/> ⓘ Note: Max. acquisition speed with 45 lighting degree accessory enabled is significantly less. Practical acquisition rate is application dependent.

LED Wavelengths

The following table shows LED types and the related peak wavelengths:

LED	λ [nm]
RED	660

Calibration

Calibration informs the verifier about the grey scale levels and pixel dimensions of the verifier. This way, the verifier can report Symbol Contrast and X-dimension in true physical units.

For ISO compliant barcode verification, make sure that the verifier is in a calibrated state.

For Standards Based Grading, the verifier does not report all quality parameters without calibration.

In an uncalibrated state the verifier does not report:

- Aperture and Symbol Contrast (SC) for ISO/IEC 15415/15416 applications
- Minimum Reflectance (MR) for ISO/IEC TR29158 (AIM-DPM) applications

Note: In an uncalibrated state, the verifier does not report aperture value, but uses the default aperture selection: Auto 50% for 1D applications or Auto 80% for 2D applications.

To calibrate the DataMan 475:

1. Click the **Calibration** icon in the top left corner in the TruCheck Verification window.
2. Enter the **Rmax** and **Rmin** values from the calibration card.

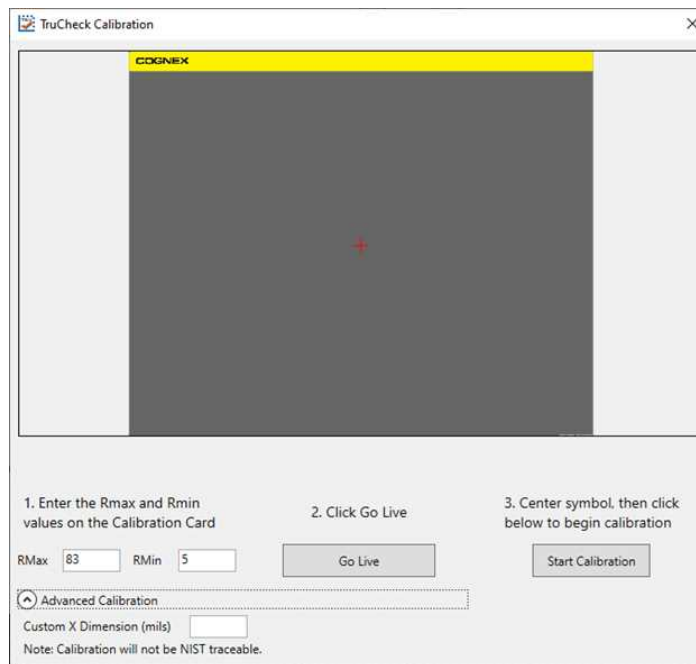

Use the Advanced Calibration option only if you use a non-NIST traceable calibration symbol. This option allows you to enter the Custom X-Dimension (mils) value of the barcode that you use to calibrate the unit. The calibration process uses the Custom X-Dimension (mils) value to calibrate dimension measurements.

3. Click **Center Target**.
4. A live image appears in the **Calibration** screen. Center the verifier over the calibration symbol.
5. Clicking **Start Calibration** prompts a Calibrating progress bar appear in the window



6. If the calibration is successful, one of two messages pop-up.

If you performed the calibration with one of the supported NIST-traceable calibration symbols, the pop-up displays the following :

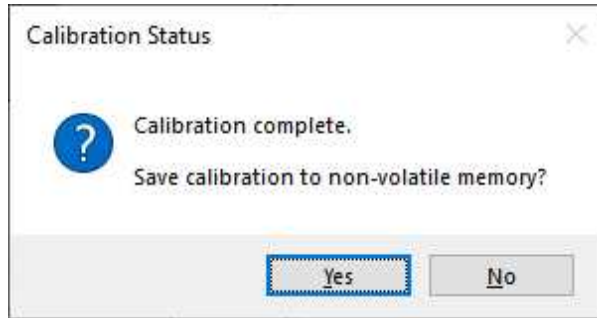

When you perform a successful calibration with a supported NIST-traceable calibration symbol, a calibration time date stamp appears on the bottom of the TruCheck window and is printed in the header of the report. For the list of NIST-traceable calibration symbols see the step list below.

If you performed the calibration successfully with any readable symbol other than the supported NIST-traceable calibration symbols, the pop-up displays the following:

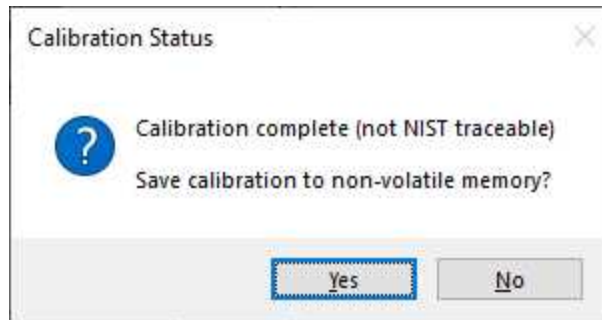

If you perform a successful calibration with a non NIST-traceable calibration symbol, no calibration date is recorded on the reports or displayed on the Main tab in the TruCheck window. Instead, The message reads "Calibration Complete (not NIST-traceable)".

If the calibration failed, see step 8.

7. For both successful calibration messages, you have the options to **Save Calibration** to non-volatile memory

If you select **Yes**, the unit saves the calibration for subsequent verifications and the values to non-volatile memory. If you power down the unit, the calibration will persist.

If you select **No**, the unit saves the calibration for subsequent verifications but does not save the values to non-volatile memory. If you power down the unit, the calibration values will be lost.

8. If the calibration failed, the pop-up displays the following message:

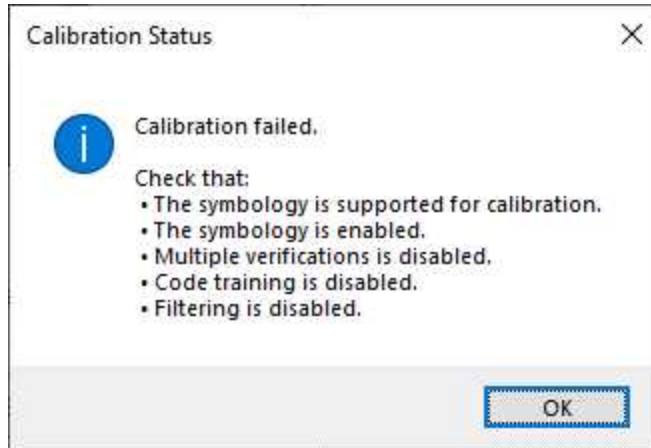

A failed calibration means that the calibration target was not detected. Ensure that:

- a valid, readable barcode is visible within the field of view
- you have selected the region of interest that includes the barcode that you use for calibration
- the calibration barcode symbology type is supported
- the calibration barcode symbology type is enabled in **Code Details** tab in the **Setup Tool** window.
- the unit is not set for multiple verifications
- no filtering is enabled

Supported NIST calibration symbols:

- 1D and 2D symbols on the Cognex Calibration Card (Cognex #DMV-CCC)
- Symbols 1 and 5 on the Applied Image Conformance Calibration Standard Enhanced Test Card for ISO IEC Datamatrix and GS1 Datamatrix (Cognex #DMV-DMCC)
- Symbol 1 on the GS1 ISO/IEC Data Matrix & GS1 Datamatrix Calibrated Conformance Standard Test Card (Cognex #DMV-GS1CC)
- EAN-13 MASTER GRADE and UPC-A MASTER GRADE symbols on the GS1 Calibrated Conformance Standard Test Card for EAN/UPC Symbol Verifiers (Cognex #DMV-AICC)

Calibrate your verifier as needed to ensure accurate verification results. Monthly calibration is recommended, or more frequently where required by internal quality guidelines.

Note: Store the calibration card away from direct light to avoid compromising the calibration symbol.

Enable a calibration reminder in Calibration Settings to alert you about the next scheduled calibration. After enabling the calibration reminder, set the number of days for prompting a calibration reminder. For more information, see [Calibration Settings on page 40](#)



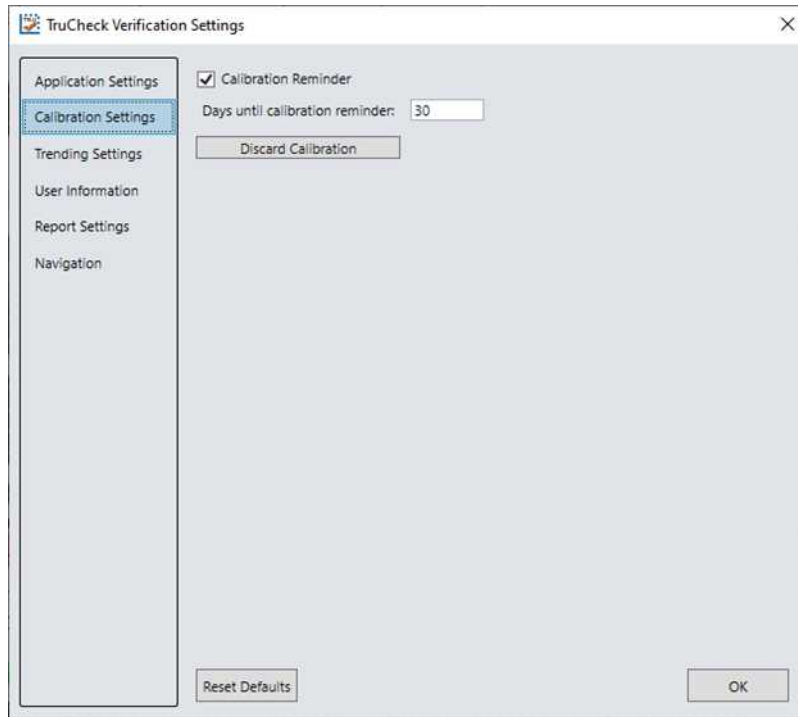

Tip: Click **Discard Calibration** to remove all calibration values and return the verifier to an uncalibrated state.



User Interface

This section describes the settings and options of the TruCheck Verification window.

Toolbar

Icon	Function
	<p>Settings: Opens up the settings menu allowing changes in the Application Settings, Calibration Settings, Trending Settings, User Information, Report Settings, and Navigation menus. For more information, see Settings on page 31.</p>
	<p>Calibration: Opens up the calibration window to calibrate the unit. For more information, see Calibration on page 14.</p>
	<p>Grid & Modulation Circles: When selected, this applies a grid and/or modulation circle to the image after verification. Use the drop-down menu to apply a Real Grid, an Ideal Grid, or both. Select one of the options to either show Mod Circles Filled or Mod Circles Outlined.</p>
	<p>Original Image: Shows the image as acquired by imager before post processing.</p>
	<p>45° illumination: Enables 45° illumination. 45° four-sided illumination is used primarily for labels. This illumination is either not reported or reported as 45Q. If illumination is not reported, it is assumed to be 45Q.</p>

Using Your DataMan 475 Verifier

Verifying a 2D Barcode

To verify a Data Matrix code or a QR code in the TruCheck Verification Window:

1. Navigate to the **Main** tab.
2. Click **Go Live** and center your symbol in the field of view, or press and release the trigger button to **Go Live**.

Note: After selecting **Go Live**, the button changes to **Verify**.

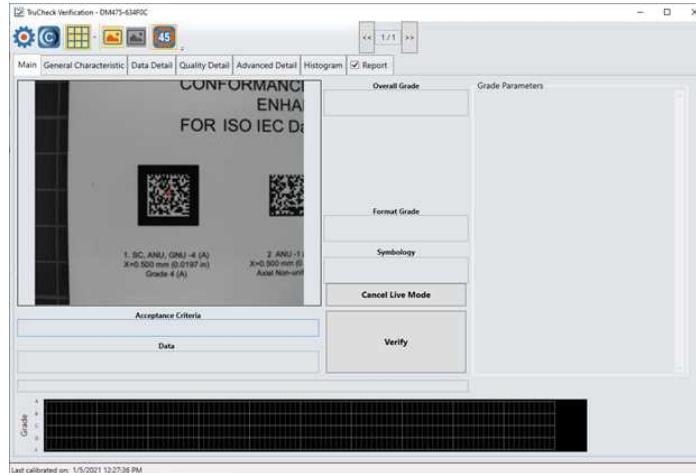

3. Draw a selection region around the code to be verified, if necessary.

Note: Make sure to draw the region around the outside perimeter of the code including quiet zones. More information on properly defining regions is explained in [Selecting Regions on page 20](#).

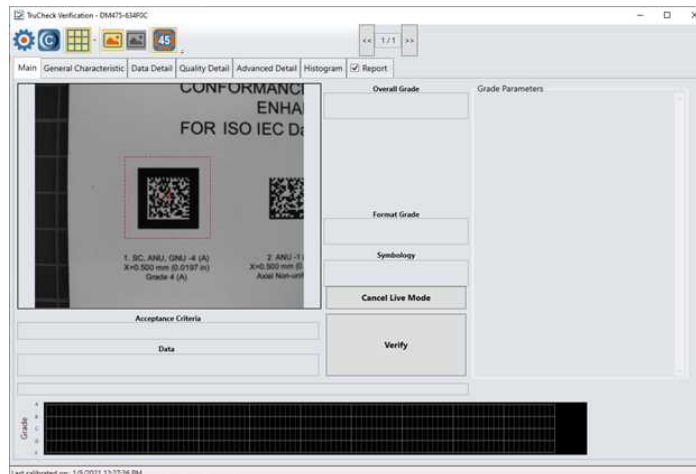

4. Click **Verify**, or press and release the trigger button on the verifier to begin verification.

Note: The following screenshot shows a successful 2D barcode verification. Additional details in the TruCheck window are displayed depending on grading and application standards.

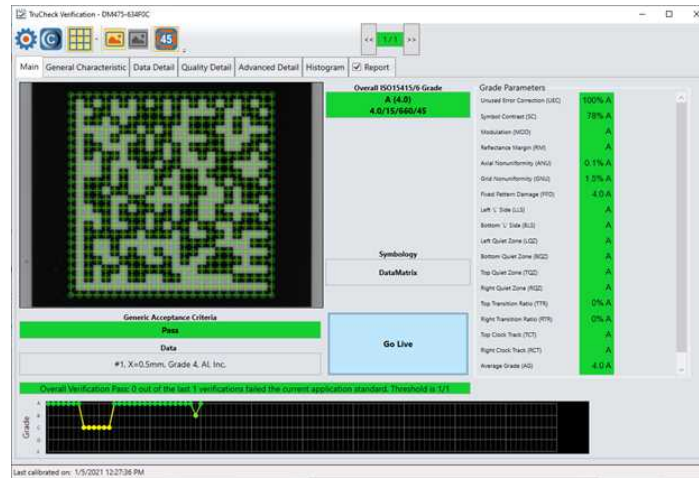

Note: Use the tool bar buttons and tabs on the screen for in-depth analysis of codes. For more information, see [Examining the Results on page 23](#).

Selecting Regions

Requirements for specifying regions on the image are the following:

- Specify a small sampling area, to speed up the verification process on verifiers with large fields of view,
- Restrict a region for image brightness adjustments when grading according to AIM-DPM (ISO/IEC 29158)
- Specify a barcode for verification when more than one barcode is present in the field of view

If you do not specify a region, the whole image is used for verification.

To specify a region, use the cursor to drag and drop.

For Data Matrix symbols and QR Codes, specify the region around the outside perimeter including quiet zones of the code to capture the entire finder pattern within the selection to properly grade the code.

When verifying a 1D symbol, select a region that includes the full width of the barcode including both quiet zones.

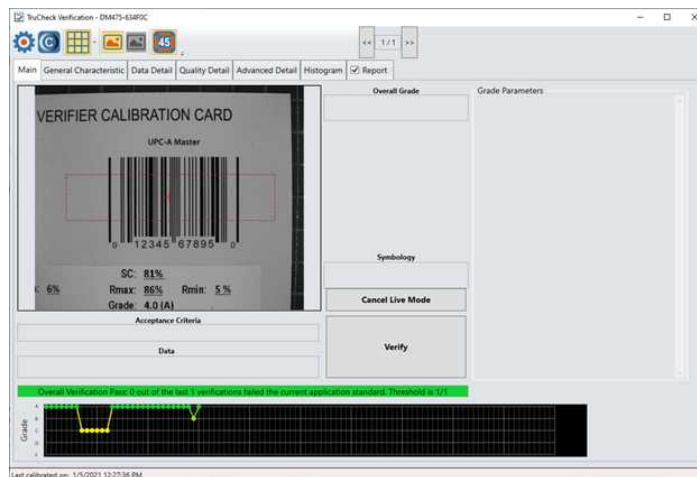

Standards Based Grading

The Standards based grading option of the DM475V uses true verification algorithms to produce well-defined, consistent results from the image of a code captured by a barcode reader in a real-world setup.

It is desirable to provide for an optical setup that is as close as possible to a fully ISO compliant verifier – especially the lighting angle. The measurements are calculated the same way as with a verifier, so the closer the setup is to a true verifier, the closer the results are to true verification. If the lighting setup is the same, the measurements between standards based grading and verification converge. Standards based grading is the closest way to achieve verification results when it is not practical to conform to specific lighting angles, distances, or every ISO standard parameter.

For Standards Based Grading, calibration is recommended. If the verifier is used without calibration, the verifier does not report all quality parameters. When you do not perform the calibration, the verifier does not report the aperture or Symbol Contrast (SC) for ISO/IEC 15415/15416 applications and Minimum Reflectance (MR) for ISO/IEC TR29158 (AIM-DPM) applications.

Note: In an uncalibrated state, the verifier does not report aperture value, but uses the default aperture selection: Auto 80% for 2D applications and Auto 50% for 1D applications.

Verifications of Multiple Symbols

To enable the multiple barcode verification feature, complete the steps in DataMan Setup Tool before initiating verification in the TruCheck window.

1. Open DataMan Setup Tool.
2. To connect to the DM475 Verifier double click on the icon in the automatically generated list on the **Start up** page.

Note: If you have trouble connecting, refer to DataMan Setup Tool Reference manual.

3. Select **Code Details** from the **Application Steps** in Setup Tool.
4. Under the **Basic** tab, change the **Number of Codes** field to a value greater than 1 to see the expanded list of options available.

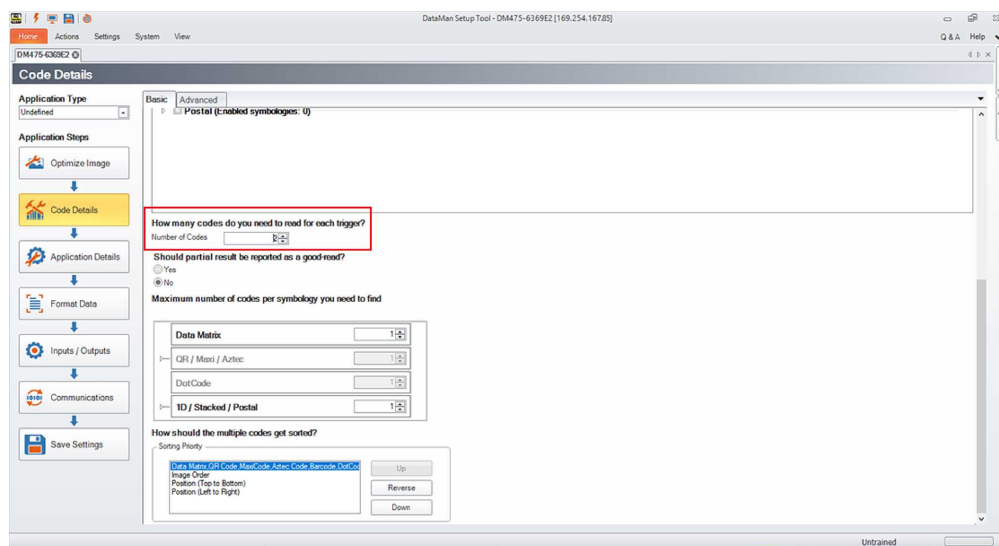

5. Select the **Number of Codes** to be verified during a single trigger.

6. For **Should partial result be reported as a good-read?** select **No**.

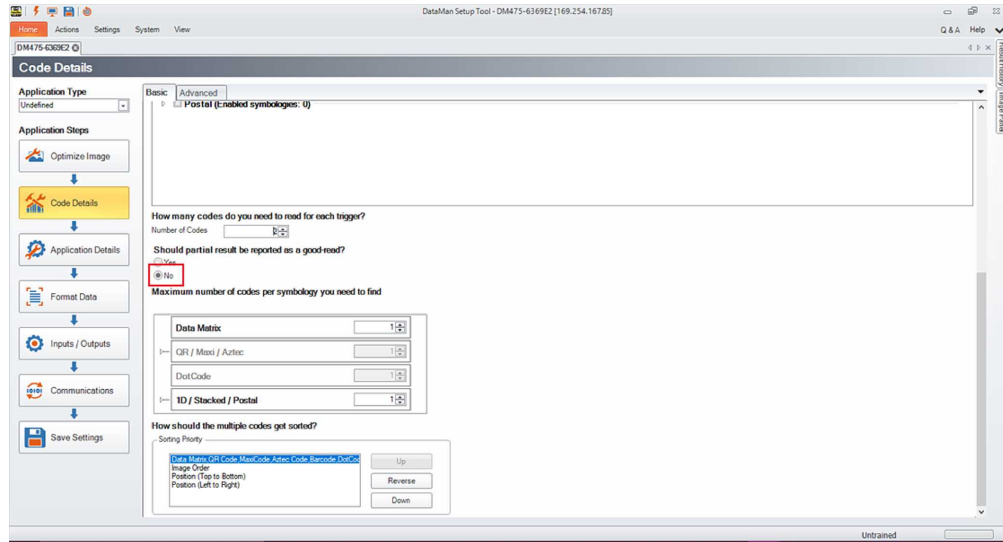

7. Select the quantity of each symbology type to be verified in a single trigger under **Maximum number of codes per symbology you need to find**.
8. Select the appropriate **Sorting Priority**.
9. Open the TruCheck window and initiate a verification.
For multiple verifications, select either a single region to identify all symbols for verification, or the entire field of view.

See the individual results in the tabs with the help of the arrows at the top of the TruCheck verification window, following the successful verification of multiple symbols. If all verifications pass, the box is green. If any verification fails, the box is red.



Saved Code Quality reports include an appended report containing individual result for each verified barcode.

Examining the Results

This section details how to view and analyze the verification results.

1D & 2D Verification

The following chapters discuss the user interface of the TruCheck Verification. The image displays the TruCheck Verification window.

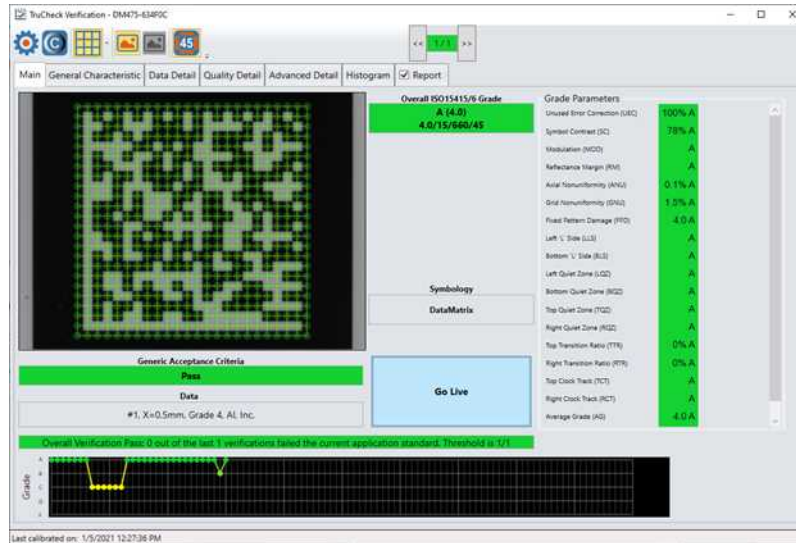

Main Tab

The **Main** tab shows a snapshot of the verification results.

Acceptance Criteria: Provides a Pass or Fail grade for the barcode and is dependent on the **Application Standard** selected. For more information, see [Application Settings on page 31](#).

Data: Shows the decoded data.

Overall Grade: Shows the overall grade results for the barcode as both a letter grade (A) and numeric grade (4.0). A Formal Grade is provided in the format “Grade/Aperture/Wavelength/Lighting”.

For example, a Formal Grade of “4.0/08/660/45” is interpreted as receiving a grade of 4.0 using 8 mil aperture (0.2 mm), 660 nm wavelength, and 45° lighting.

Format Grade: Indicates PASS or FAIL, depending on the **Application Standard** or **Data Format Check** criteria selected. For more information, see [Application Settings on page 31](#)

Symbology: The name of the type of barcode (for example, *Data Matrix* or *Code 128*).

Grade Parameters: Provides information on the Quality Parameters grading for the barcode. For more information, see [Quality Detail Tab on page 27](#).

Grade Trending:



The TruCheck window shows the grade trending values for symbol verified over time. The graph at the bottom of the **Main** window shows data points associated with the overall grade for each symbol verified. The grade trending reports the data point for each Overall Grade.

In verifications where a symbol passes all quality parameters but, for another reason, fails the acceptance criteria such as data parsing error or x-dimension range, the grade is shown as an F. For example, if a symbol receives an overall grade of A (4.0) but fails for an X-dimension out of range, grade trending marks the data point as an F.

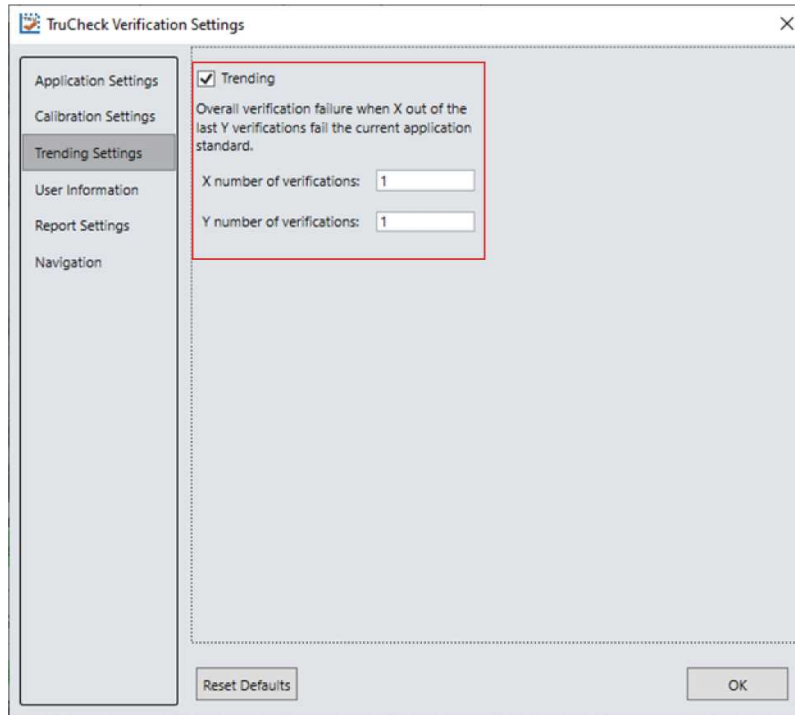

1. Enable or disable **Grade Trending** using the **Trending** checkbox in the **Trending Settings** menu.
2. Set a tolerance range for the number of verifications (x) allowed to fail out of the total number of verifications (y) specified.

If the trending point falls below the specified threshold, trending is reported as an Overall Verification Failure. The Pass Grade value set in the **Application Settings** menu determines if a symbol is a pass or fail for Grade Trending purposes. Grade Trending does not show data points for verifications that result in a NO DECODE evaluation.

Note: Grade Trending data points remain populated and continue to trend on the **Main** window until you disconnect the power from the verifier.

General Characteristics Tab

The **General Characteristic** Tab shows the physical characteristics of the verified barcode.

The image shows the characteristics of a Data Matrix barcode:

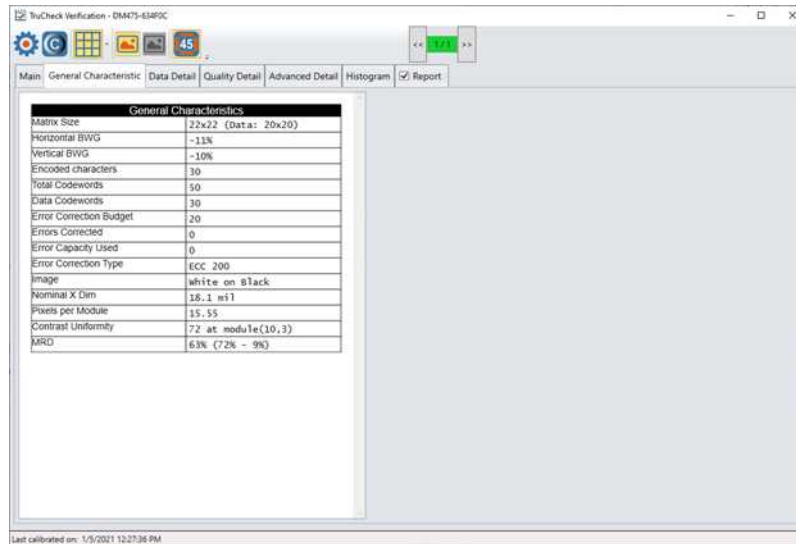

Contrast Uniformity verifies conformance with ISO/IEC 15426-2 as shown in the **General Characteristics** tab. Some of the contents of this screen depend on the symbology and settings on the **Report Settings** menu.

The image shows the characteristics of a 1D barcode:

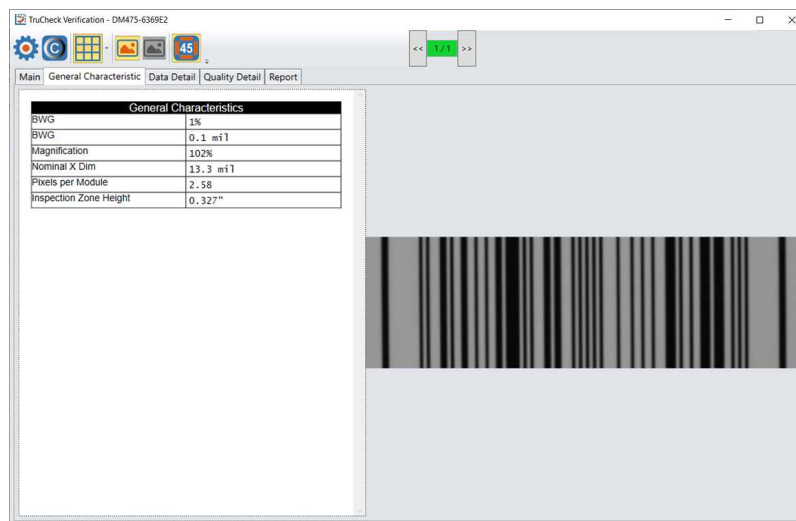

Data Detail Tab

The **Data Detail** tab shows all of the data encoded in the symbology in various ways, and makes the understanding of the symbology easier. The verbose interpretation of the symbology is especially helpful when the data is encoded incorrectly. The level of detail depends on the symbology and the selected **Application Standards**.

The image shows the encoding information of a Data Matrix and the depiction of the symbol showing each module:

The **Data Detail** tab contains the following parameters:

Data Parameter	Content
Data	refers to the data decoded from the symbology in normal, printable characters.
Unicode Data	shows the data interpreted as Unicode characters. The characters are the same as the characters in Data section, except when the data in the symbology encodes non-latin characters, such as Kanji, using Unicode encodation.
ASCII Values	gives ASCII value of each decoded character. ASCII values are helpful in case an unprintable character is encoded in the symbology and you need to confirm that the character is correct. For example, by looking at the ASCII values table you can see that a <GS> in the decoded data is actually the ASCII character with decimal value of 29, and not the four characters: “less than”, G, S, “greater than”.
Codewords if applicable	section lists the values of the raw codewords encoded in the symbology, including the error correction codewords. An asterisk (*) denotes codewords which were decoded incorrectly and determined through error correction decoding.
Encodation Analysis if applicable	shows the detailed conversion of raw codewords into decoded ASCII values using the encodation and compression methods defined for the symbology. For example, in Data Matrix an encodation method known as C40. The C40 method encodes 3 ASCII characters in only two codewords. Similarly, PDF417 and other 2D symbologies have various methods of encoding different types of data (such as numeric only data) in efficient ways. The encodation analysis table can show you the process of this encodation or decoding.

Modulation table legend

To help interpret the color coding associated with the modulation table on the Data Detail tab, the software provides a legend. The letter grade associated with each modulation value range is shown on the left. The colors are distinguished based on whether the module is light (white) or dark (black).

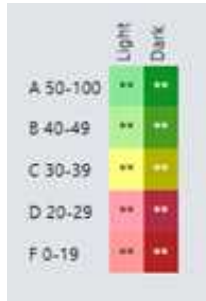

When a data checking failure occurs, a message indicates the cause of the failure.

For example, if a check digit is incorrect, a message indicates the expected check digit value. When the verification detects an error, the application stops the parsing and generates a report.

When you hover over the codewords in the Data Matrix **Codeword table**, the Code module display highlights modules constituting the 8-bit codeword and are highlighted within the image to show where the data is encoded within a Data Matrix symbol.

The screenshot shows the 'Quality Detail' tab in the TruCheck Verification software. The interface includes several data analysis sections:

- Data:** #1, X=0.5mm, Grade 4, AI, Inc.
- Unicode Data:** #1, X=0.5mm, Grade 4, AI, Inc.
- ASCII Values:** A table of ASCII values for characters 0-9.
- Codewords:** A list of codewords and their corresponding data values.
- Encodation Analysis:** A table showing the mode and result for various codewords.

On the right side, there is a 2D Data Matrix grid with a color-coded modulation table legend overlaid on it. The legend shows letter grades (A, B, C, D, F) and their corresponding color coding for light and dark modules.

Quality Detail Tab

The **Quality Detail** tab shows the measured quality parameters and lists the formal grade. Different symbologies and quality grading standards display pertinent data on the **Quality Detail** tab.

Characteristics of a 2D Data Matrix code graded according to ISO 15415:

TruCheck Verification - DM475-6369E2

Main | General Characteristic | Data Detail | Quality Detail | Advanced Detail | Histogram | Report

Verification Grade				
Overall	Aperture	Wavelength	Lighting	Format
A (4.0)	16	660	45	4.0/16/660/45

ISO15415 Quality Parameters

Item	Grade	Value	Unit	Pass
1. Unused Error Correction (UEC)	A	100%		PASS
2. Symbol Contrast (SC)	A	80%	Ri/Rd (84/3)	PASS
3a. Modulation (MOD)	A			PASS
3b. Reflectance Margin (RM)	A			PASS
4. Axial Nonuniformity (ANU)	A	0.1%		PASS
5. Grid Nonuniformity (GNU)	A	3.1%		PASS
6. Fixed Pattern Damage (FPD)	A	4.0		PASS
7. Left 'L' Side (LLS)	A			PASS
8. Bottom 'L' Side (BLS)	A			PASS
9. Left Quiet Zone (LQZ)	A			PASS
10. Bottom Quiet Zone (BQZ)	A			PASS
11. Top Quiet Zone (TQZ)	A			PASS
12. Right Quiet Zone (ROZ)	A			PASS
13. Top Transition Ratio (TR)	A	0%		PASS
14. Right Transition Ratio (RTR)	A	0%		PASS
15. Top Clock Track (TCT)	A			PASS
16. Right Clock Track (RCT)	A			PASS
17. Average Grade (AG)	A	4.0		PASS
18. DECODE	A			PASS

Characteristics of a 1D UPC-A symbol graded according to ISO 15416:

TruCheck Verification - DM475-6369E2

Main | General Characteristic | Data Detail | Quality Detail | Report

Verification Grade				
Overall	Aperture	Wavelength	Lighting	Format
B (3.2)	11	660	45	3.2/11/660/45

ISO15415 Quality Parameters

Item	Grade	Value	Unit	Pass
1. Edge	A	59		PASS
2. Reflectance Light / Reflectance Dark (Ri/Rd)	A	79/4		PASS
3. Symbol Contrast (SC)	A	75%		PASS
4. Minimum Edge Contrast (MinEC)	A	60%		PASS
5. Modulation (MOD)	A	80%		PASS
6. Defect (Def)	A	0%		PASS
7. Decode (DCC)	A	10/10		PASS
8. Decodability (DEC)	B	52%		PASS
9. Minimum Quiet Zone (MinQZ)	A	9		PASS

Individual Scan Results

Scan #	Edge	MinRed	SC	MinEC	MOD	DEF	DECODE	DEC	QZ
1	A	A	A	A	A	A	A	A	A
2	A	A	A	A	A	A	A	A	A
3	A	A	A	A	A	A	A	B	A
4	A	A	A	A	A	A	A	B	A
5	A	A	A	A	A	A	A	B	A
6	A	A	A	A	A	A	A	B	A
7	A	A	A	A	A	A	A	B	A
8	A	A	A	A	A	A	A	B	A
9	A	A	A	A	A	A	A	B	A
10	A	A	A	A	A	A	A	B	A

For more information on grading standards, see [Grading Standards and their Parameters on page 50](#).

Advanced Detail Tab

The **Advanced Detail** tab shows in-depth information on the verified code. Depending on the type of the 1-D or 2-D code that was verified, the information on the **Advanced Detail** tab may vary.

The example shows the modulation values from a Data Matrix symbol:

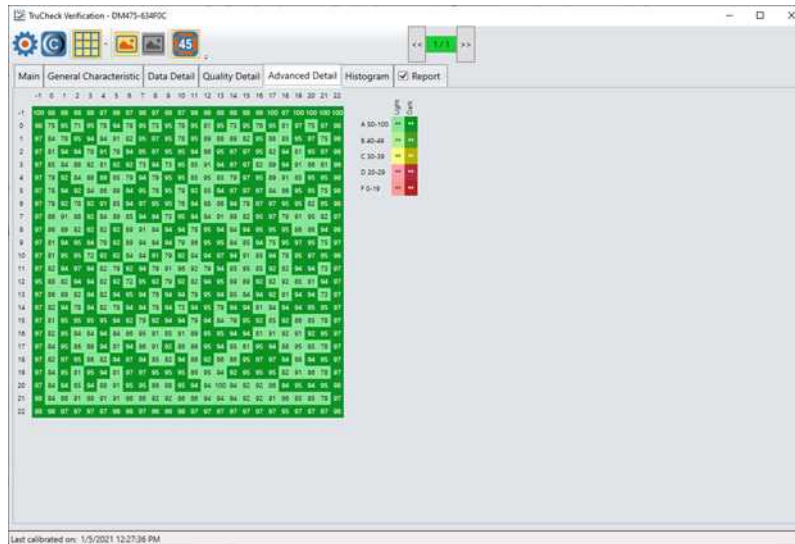

For more information on modulation calculation, see [Grading Standards and their Parameters on page 50](#).

Histogram Tab

The **Histogram** tab shows the analysis of the reflectivity of each cell and associated grade.

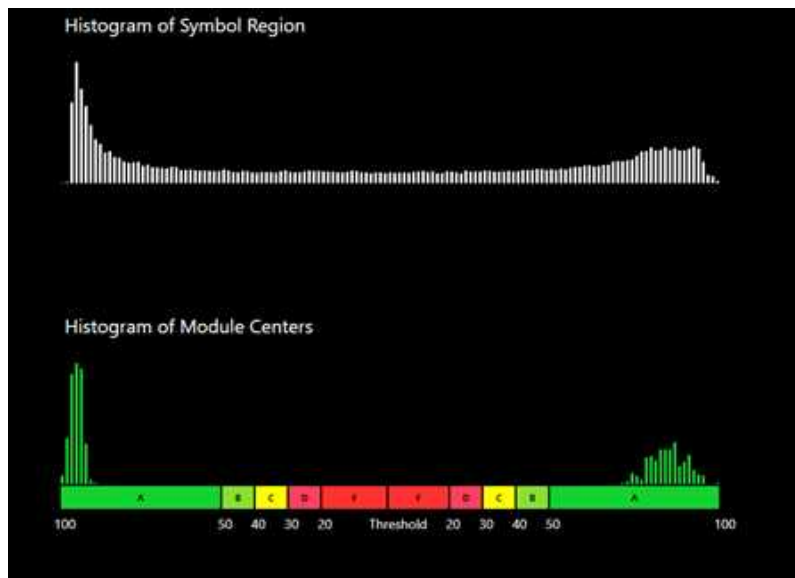

The horizontal axis on the **Histogram** represents the brightness level with the dark elements on the left side and the bright elements on the right side. As the element's brightness increases, the **Histogram** displays the element farther to the right of the **Histogram**. The height of each bar represents the number of elements with the same brightness associated with the elements' positions on the horizontal axis.

The top graph of the **Histogram** represents the brightness of all the pixels in the code region. The bottom graph of the **Histogram** represents the sampled module locations in the symbol.

The horizontal axis contains markers showing the global threshold, and all modulation levels are separated for both dark and light elements.

Note: When grading according to ISO/IEC TR29158 (AIM-DPM), the **Histogram** gets different labeling. The location of the 0% and 100% labels on the horizontal axis are at the means of the dark and light lobes of the Histogram and there is no C level because the DPM grading method uses only A, B, D and F levels for Cell Modulation.

Report Tab

To enable the Code Quality report to become available in the **Report** tab, enable the **Generate Code Quality reports** in the **Results History** panel of Setup Tool.

Note: Minimize TruCheck window and click Setup Tool window on the taskbar.

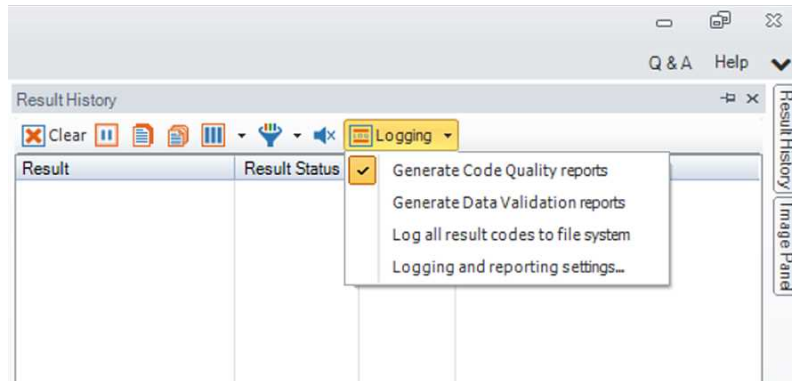

Note: The Code Quality report contains the results specific to verification when the verification feature key is installed and verification is enabled in the Setup Tool window. The Code Quality report contains the results and separate from the previous Code Quality results that Process Control Metrics (PCM) generate.

When you enable the **Code Quality report**, the **Report** tab becomes available in the **TruCheck Verification** window showing full verification results formatted into a printable report.

Alternatively, you can check the the checkbox on the **Report** tab in the **TruCheck Verification** window.



Settings

This section describes the settings and the options available in the **TruCheck Verification** window.

The Settings Menu

To access **Settings**, select **Settings** in the upper left corner of the **TruCheck Verification** window.

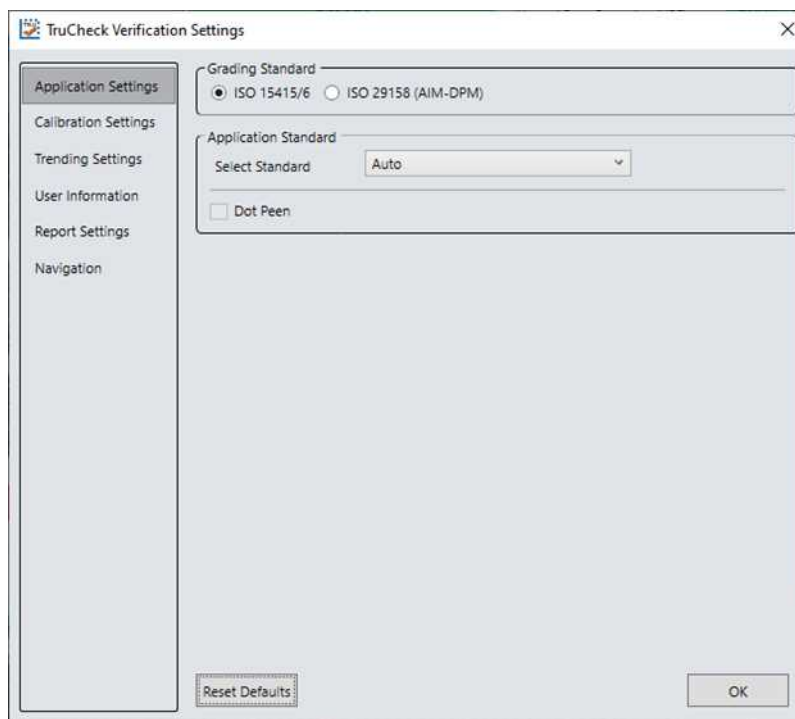

Application Settings

The content of the **Application Settings** window depends on which Application Standard you select. The application standard setting automatically sets many of the parameters. Selecting a pre-defined application standard ensures that the DM475 Verifier uses the appropriate grading parameters for your application. See all pre-defined Application Standards under *Application Standards Settings* chapter. The **Custom** application standard allows you to customize all adjustable verification and process parameters.

The **Reset Defaults** button resets the **Application Settings** menu to the default settings (Auto). After clicking **Reset Defaults**, you must calibrate the verifier before using it. For more information, see [Calibration on page 14](#).

Application Standards Settings

Application Standards configure the verifier to grade according to pre-defined rules established by an industry standards body or other industry requirements.

Specify ISO/IEC 15415 grading method for labels or ISO/IEC 29158 (AIM-DPM) grading method under **Grading Standards** in the **TruCheck Verification** settings window. For more information, see [Grading Standards and their Parameters on page 50](#).

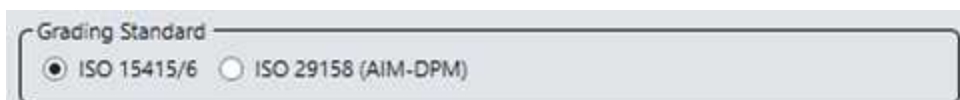

Select one of the options provided in the drop down box to specify the application standard.

You have the following application standard options:

GS1

GS1 application standard follows GS1 General Specification guidelines in code verification. GS1 General Specification Tables 1-11 describe several categories of applications. Select from the tables to specify the application category for your codes.

If you select Auto(Warn if Ambiguous), the most applicable General Specification Table is automatically selected for you.

Note: The DM475 Verifier uses the X-dimension of the decoded symbol to deduce which table applies. If the X-dimension is outside of the range allowed in your application, results will be incorrect. To make sure that the verifier checks all the correct requirements for your application, select the Table in the GS1 General Specifications that applies to your application.

The selected GS1 table is available in the **Notes** section of the report. For more information on the tables used for analysis, see [GS1 General Specifications Standard](#).

Select **Dot Peen**, if applicable. For more information, see the description of **Dot Peen** under **Data Format Check**.

TruCheck Verification Settings

Application Settings

Calibration Settings

Trending Settings

User Information

Report Settings

Navigation

Grading Standard

ISO 15415/6 ISO 29158 (AIM-DPM)

Application Standard

Select Standard: GS1

Dot Peen

Auto (Warn if Ambiguous)

Automatically Determine which GS1 Table to be used

Reset Defaults OK

UID (MIL-STD-130)

The UID (MIL-STD-130) application standard reports the quality standard according to the MIL-STD 130 specifying UID marks Construct 1 and Construct 2 that use data structure and code grade for verification. The MIL-STD 130 spells out acceptable grades and requirements for data format.

Specify either the ISO 15415 grading or the ISO 29158 (AIM-DPM) grading for the MIL-STD-130 UID Application Standard. For more information, see [Grading Standards and their Parameters on page 50](#).

Select **Dot Peen**, if applicable. For more information, see the description of **Dot Peen** under **Data Format Check**.

TruCheck Verification Settings

Application Settings

Calibration Settings

Trending Settings

User Information

Report Settings

Navigation

Grading Standard

ISO 15415/6 ISO 29158 (AIM-DPM)

Application Standard

Select Standard: UID (MIL-STD-130)

Dot Peen

Reset Defaults OK

UDI (GS1 or HIBCC)

The UDI (GS1 or HIBCC) application standard checks symbols that meet UDI requirements using either GS1 or HIBCC guidelines.

Specify the ISO 15415 grading or the ISO 29158 grading. For more information, see [Grading Standards and their Parameters on page 50](#).

Select **Dot Peen**, if applicable. For more information, see the description of **Dot Peen** under **Data Format Check**.

UDI compliance requires data content that varies depending on the medical device the data is applicable to, so the DM475 Verifier only validates the format, not the content. Validating format is automatic and in accordance with formatting rules of the chosen grading standard guidelines.

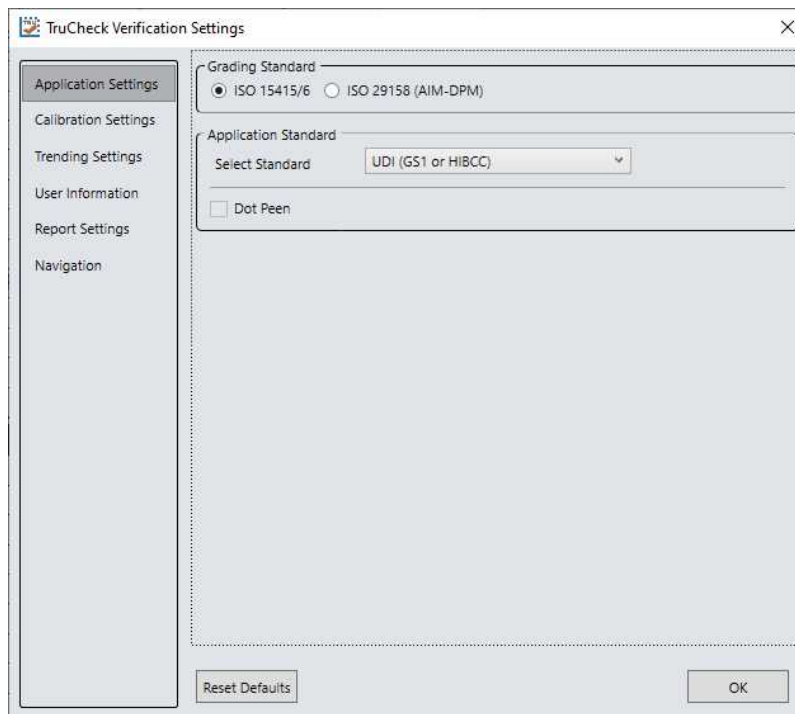

Custom

Apply the **Custom** standard option when you are grading a code that is not expected to adhere to any pre-defined industry conformance standard, and so it can be customized with specific settings for:

- Grading Standard: ISO 15415 or ISO 29158, for more information, see [Grading Standards and their Parameters on page 50](#).
- Minimum and Maximum X-dimension
- Overall Pass Grade
- Data Format Check
- Aperture Size

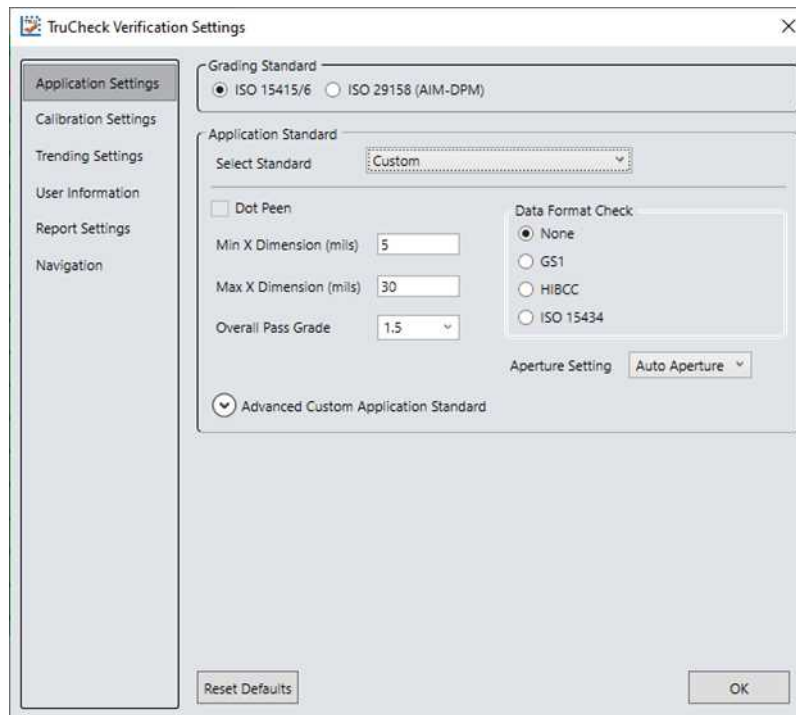

The **Custom** application setting options include **Advanced Custom Application Standard** option for the customization of grading by each individual quality parameter. The **Advanced Custom Application Standard** options allow you to select individual pass thresholds for each Quality Parameter for 1D and 2D symbologies. If a pass grade is selected for any of the Quality Parameters, the Overall Pass Grade, the Acceptance Criteria evaluation of Pass or Fail is overridden for that parameter.

For example, if you set the Overall Pass Grade to 1.5 and the Grid Non-Uniformity value individually to 3.5, a symbol graded with a GNU value below 3.5 will be given an Acceptance Criteria of Fail (Quality) even if the Overall Grade is greater than 1.5. If you set all Advanced Custom options to N/A, the verification does not apply any advanced custom application standard settings and will evaluate the Quality Parameters according to the value in the Overall Pass Grade only.

We strongly recommend to utilize the **Advanced Custom Application Standard** settings only in specific cases by users with a strong understanding of their application. Changing the Advanced Custom Application Standards will directly impact the Overall Grade during verification.

In addition, the **Advanced Custom Application Standard** menu provides options to choose between ISO 18004 Quiet Zone (QZ) Requirement of a 4-module quiet zone or the ISO 16480 QZ Requirement of a 1-module quiet zone.

Advanced Custom Application Standard gives users the option to select between the ISO 29158:2011 standard or the ISO 29158:2020 standard.

At the bottom of the menu, a button is provided to Clear Advanced Parameters and reset all values back to N/A.

TruCheck Verification Settings

Application Settings

Calibration Settings

Trending Settings

User Information

Report Settings

Navigation

Advanced Custom Application Standard

1D Pass Thresholds		2D Pass Thresholds	
Edge	N/A	Unused Error Correction	N/A
Minimum Reflectance	N/A	Symbol Contrast/Cell Contrast	N/A
Symbol Contrast	N/A	Modulation/Cell Modulation	N/A
Minimum Edge Contrast	N/A	Reflectance Margin	N/A
Modulation	N/A	Axial Nonuniformity	N/A
Defect	N/A	Grid Nonuniformity	N/A
Decode	N/A	Fixed Pattern Damage	N/A
Decodability	N/A	Average Grade/Distributed Damage Grade	N/A
Quiet Zone	N/A	Minimum Reflectance	N/A
Unused Error Correction	N/A	Matrix Size	N/A x N/A
Bar Width Growth (%)	N/A	Bar Width Growth (%)	N/A
Inspection Zone Height (mils)	N/A	Contrast Uniformity	N/A

QR Quiet Zone

ISO 18004 QZ Requirement (4)

ISO 16480 QZ Requirement (1)

Reset Defaults

OK

TruCheck Verification Settings

Application Settings

Calibration Settings

Trending Settings

User Information

Report Settings

Navigation

Advanced Custom Application Standard

Minimum Reflectance	N/A	Symbol Contrast/Cell Contrast	N/A
Symbol Contrast	N/A	Modulation/Cell Modulation	N/A
Minimum Edge Contrast	N/A	Reflectance Margin	N/A
Modulation	N/A	Axial Nonuniformity	N/A
Defect	N/A	Grid Nonuniformity	N/A
Decode	N/A	Fixed Pattern Damage	N/A
Decodability	N/A	Average Grade/Distributed Damage Grade	N/A
Quiet Zone	N/A	Minimum Reflectance	N/A
Unused Error Correction	N/A	Matrix Size	N/A x N/A
Bar Width Growth (%)	N/A	Bar Width Growth (%)	N/A
Inspection Zone Height (mils)	N/A	Contrast Uniformity	N/A

QR Quiet Zone

ISO 18004 QZ Requirement (4)

ISO 16480 QZ Requirement (1)

Grading Standard

ISO 29158:2020 ISO 29158:2011

Clear Advanced Parameters

Reset Defaults

OK

Auto

Apply the **Auto** application standard option to allow the verifier to select the correct application standard based on the format of the data encoded in the symbology. If the verifier detects GS1, HIBCC or MIL-STD 130 standards within a symbology during verification, the verifier uses the correct application standard, respectively.

Note: Select the **Custom** application standard instead of **Auto** if the symbology contains data structure that the grading of the automatic standards do not apply.

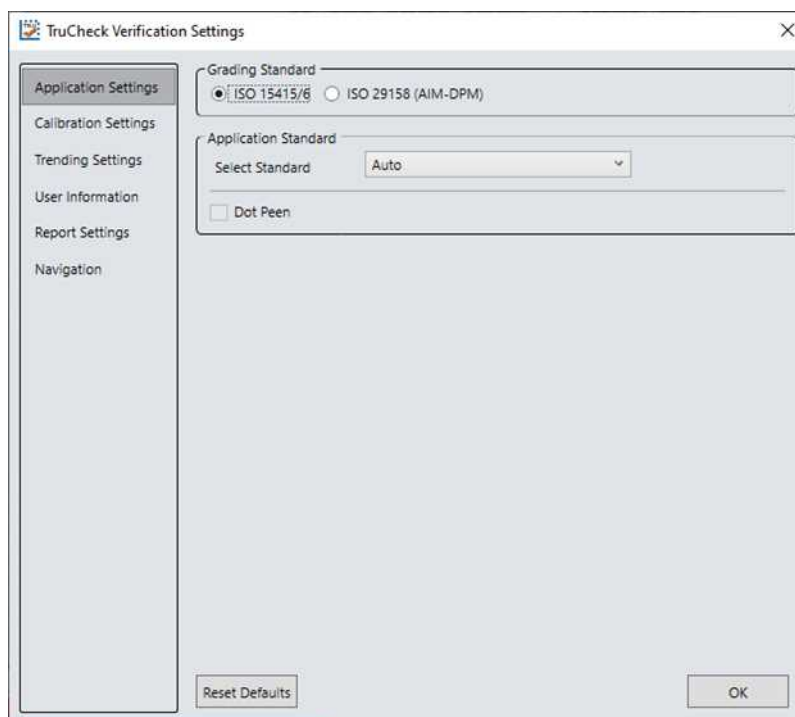

Cryptocode

The **Cryptocode** application standard checks symbols that meet Russian Cryptocode standard or other Cryptocode applications.

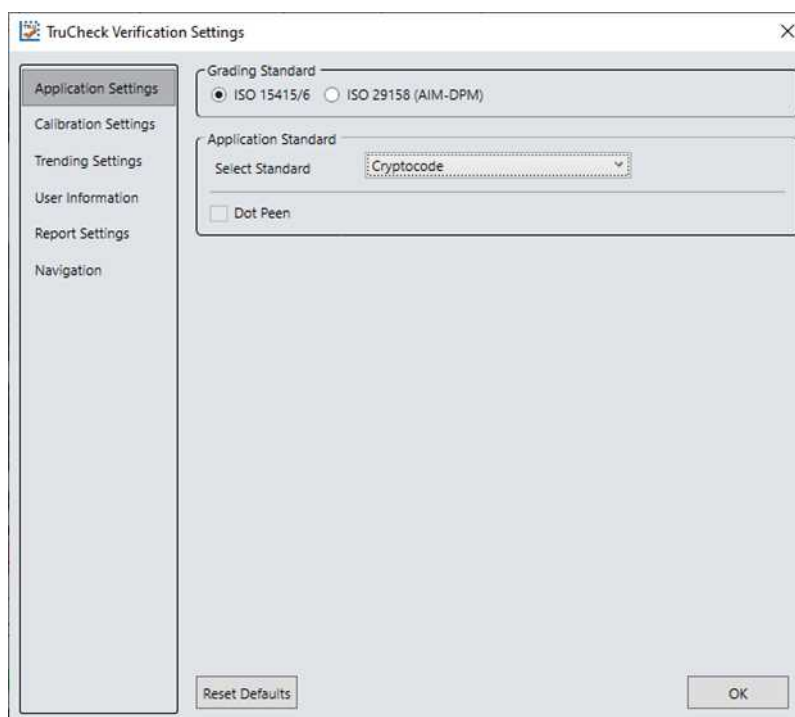

Grading Standards

For any Application Standard selected, you need to select either ISO 15415/6, or ISO 29158 (AIM-DPM) grading standard depending on your application.

- **ISO 15415/6:** Used for 2-D and 1-D label based coder reports, and displays verification results according to ISO/IEC 15415 and 15416.
- **ISO 29158 (AIM-DPM):** With ISO 29158 (AIM-DPM), you can select Dot Peen. When using AIM-DPM Grading, verification uses X-dimension range instead of the aperture setting in accordance with the AIM-DPM methodology.

For more information, visit support.cognex.com, and navigate to Resources > Introduction to Barcode Verification.

Data Format Check

You can apply a specific **Data Format Check** criteria to the data content of the code or leave the option as **None**. If you apply a specific Data Format Check, a **Data Format Check** grading box becomes available on the main screen of the User Interface to show the Pass or Fail grade. The report contains a Data Format Check table showing detailed parsing information.

- **GS1:** The GS1 option checks the format of the data against GS1 formatting rules. GS1 codes generally begin with a Function 1 <F1> character.
- **HIBCC:** The HIBCC option checks the format of the data against HIBCC formatting rules. HIBCC codes generally begin with a + character.
- **ISO 15434:** The ISO 15434 option checks data for many industry standards which encode information using ISO/IEC 15434 data structures. ISO 15434 codes generally begin with the sequence `]]><RS>\n\n<GS>` where `nn` are two digits which are typically 05, 06 or 12. MIL-STD-130 and some shipping container applications use this formatting style.

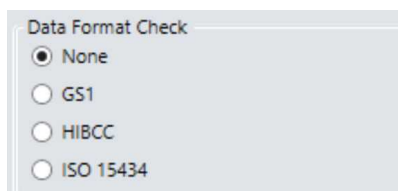

Dot Peen

Use the dot peen option for codes created through a process where dots are peened onto a metal surface. Select **Dot Peen** to use the AIM-DPM Stick algorithm to connect dots.

Min X-Dimension (mils)

Set the minimum x-dimension value. It is not possible to set the value lower than 1 mil. Any code that falls below the minimum x-dimension receives a grade of Fail (X-Dimension out of Range). If you do not specify a minimum x-dimension, the application default is 5 mils.

Max X-Dimension (mils)

Set the highest possible x-dimension value. The highest value that can be set is 100 mils. Any code that is above the maximum x-dimension receives a grade of Fail (X-Dimension out of Range). If you do not specify a maximum x-dimension, the application defaults to 30 mils.

Pass Grade

Select a minimum passing grade based on a letter and a number which is C >1.5. Any verified code that does not receive an Overall Grade above the Pass Grade minimum receives a grade of Fail for Pass Grade on the User Interface and in the Report.

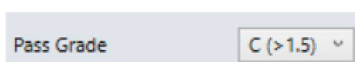

Aperture Setting

Aperture setting refers to a synthetic aperture as opposed to an optical aperture. Aperture is a circular region imposed on the pixels which comprise the individual modules making up the code. This process is mandated by the ISO 15415 and 15416 standards. Set the aperture settings when choosing Generic Application Standards.

Aperture Size setting is compatible with ISO/IEC 15415 only. AIM-DPM grading includes a blurred reference image, similar to ISO 15415. The AIM-DPM grading method dictates the aperture size to be either 50% or 80% of the symbol X-dimension.

Note: Aperture setting must match the Application Standard.

Larger aperture sizes reduce:

- Sensitivity to printing defects
- Ability to resolve small elements in a code

The size of the aperture is limited by the X-dimension of your symbols, or the X-dimension of your symbols is limited by the size of your aperture. Choose aperture size in application specification, quality specification or both. If you do not know the correct aperture size to select, choose **Auto** and the verifier uses guidelines in ISO 15415 to choose an aperture size based on the X-dimension of the code.

Always specify an aperture size for the Generic Application Standard when using ISO/IEC 15415 Grading Standard.

In the drop down menu, select:

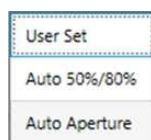

User Set

The application allows you to specify the **Aperture Setting**. If you select **User Set**, an additional drop down menu shows up for you to select the aperture.

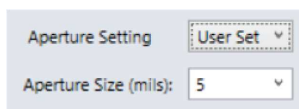

Auto Aperture

This chapter describes available automatic aperture settings.

Auto 50% or 80%

The application automatically sets an aperture size based on 50% of the X-dimension for 1D symbologies and 80% of the X-dimension for 2D symbologies.

Auto Aperture for 1D Barcodes

The application automatically sets an aperture size based on the X-dimension in accordance with the suggestion in ISO/IEC 15416. For the Generic Application Standard, the following table applies for most symbologies:

X-Dimension	Aperture
≤ 7.0 mil	03 (3 mil)
$7.1 \text{ mil} < x \leq 13 \text{ mil}$	05 (5 mil)

13 mil < x ≤ 25 mil	10 (10 mil)
> 25 mil	20 (20 mil)
For UPC/EAN, regardless of X-dimension or magnification	06 (6 mil)

You can override these rules by determining a specific aperture directly for any application that requires a specified aperture. An application specification (such as GS1 Gen Spec, or MIL-STD 129) specifies an aperture value which can be different than what the rules in the table would yield.

Auto Aperture for 2D Barcodes

The application automatically sets an aperture size based on the X-dimension in accordance with the suggestion in ISO/IEC 15415. For the Generic Application Standard, the following table applies for most symbologies.

X-Dimension	Aperture
≤ 6 mil	02 (2 mil)
6 mil < x ≤ 7.5 mil	03 (3 mil)
7.5 mil < x ≤ 10 mil	05 (5 mil)
10 mil < x ≤ 20 mil	08 (8 mil)
20 mil < x ≤ 30 mil	16 (16 mil)
≥ 30 mil	20 (20 mil)

Note: AIM-DPM grading (ISO/IEC TR 29158) always selects an aperture automatically based on the X- Dimension of the decoded symbol, which overrides the above rules. These rules only apply to ISO/IEC 15415 grading when **Auto Aperture** is selected.

Calibration Settings

The **Calibration Settings** menu allows users to enable a reminder for calibration as well as set the number of days that have elapsed since the previous calibration for the reminder. In addition, a button is provided to **Discard Calibration** and return the verifier to an uncalibrated state.

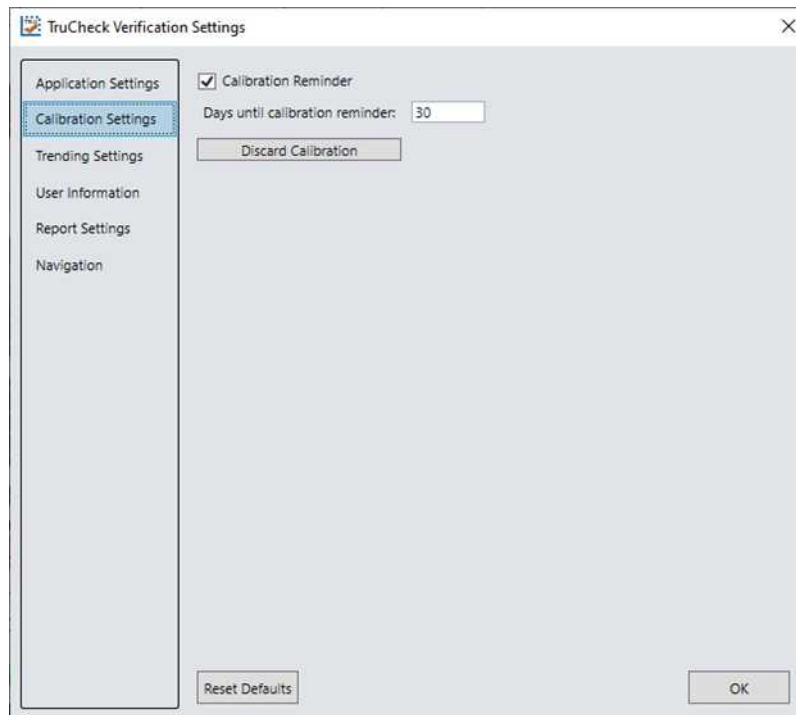

Trending Settings

The **Trending Settings** menu allows users to set the threshold that determines if the trending is evaluated as Pass or Fail. With the option to set the values for x and y, you can establish an overall verification failure when X out of the last Y verifications fail the current application standard.

For example, if you set X to 3 and Y to 10, a message will show above the trending graph stating "Overall Verification Failure: 0 out of the last 0 verifications failed the current application standard. Threshold is 3/10" whenever 3 or more of the last 10 verifications resulted in a failing Overall Grade.

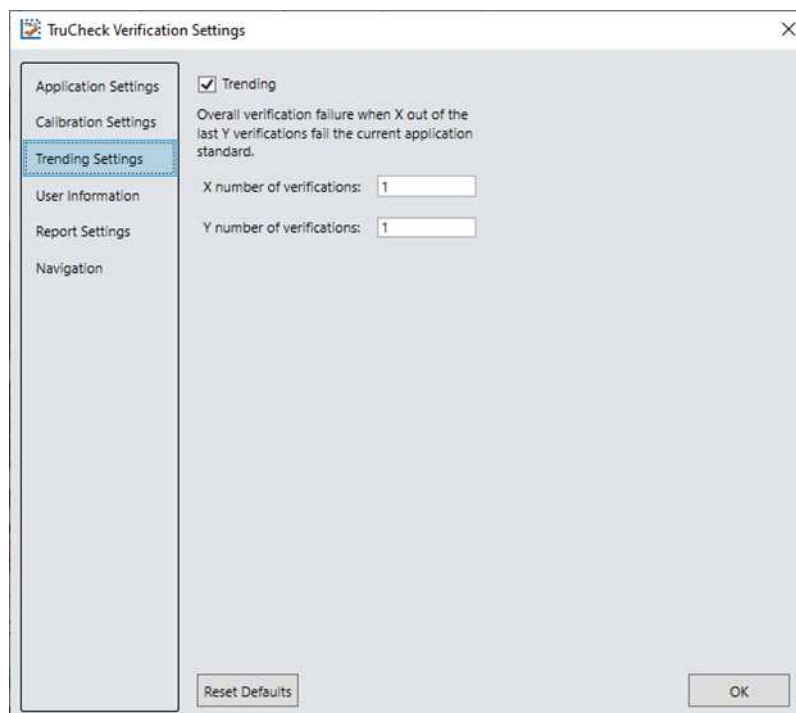

User Information

The **User Information** menu provides fields for the user to include the Company Name, Operator Name, and Batch Number that are then added to the header of the report. Auto Batch check-box allows any batch number that is detected in the barcode to be added to the report. For example, if a GS1 DataMatrix symbol is verified that includes the Application Identifier for batch number, the batch number included is reported. Custom Note allows you to add a wide variety of information to the report.

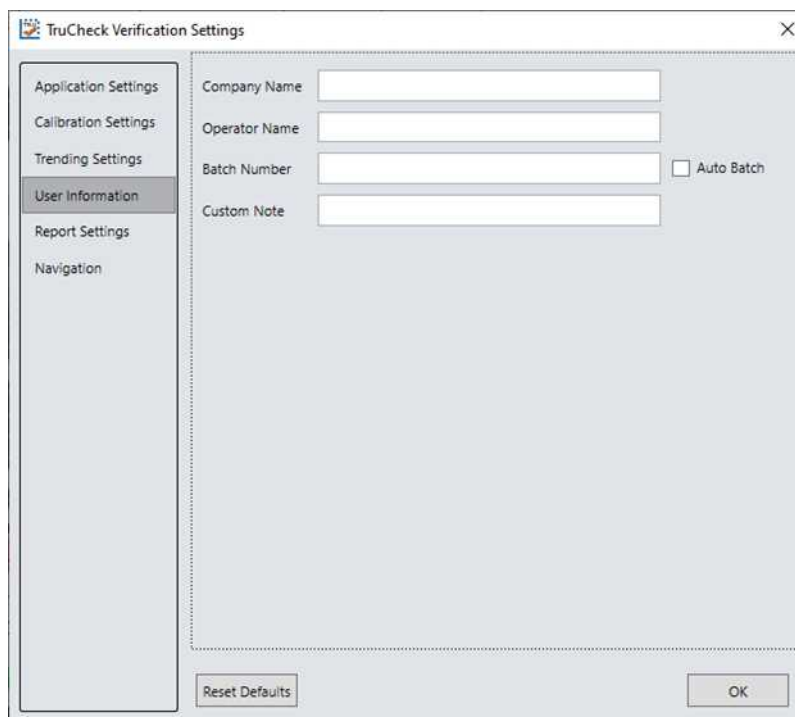

The screenshot shows the 'TruCheck Verification Settings' dialog box with the 'User Information' tab selected. The dialog has a sidebar on the left with the following menu items: Application Settings, Calibration Settings, Trending Settings, User Information (highlighted), Report Settings, and Navigation. The main area contains four input fields: 'Company Name', 'Operator Name', 'Batch Number', and 'Custom Note'. To the right of the 'Batch Number' field is an unchecked checkbox labeled 'Auto Batch'. At the bottom of the dialog are two buttons: 'Reset Defaults' and 'OK'.

Report Settings

The **Report Settings** menu allows you to select the unit of measurement for reporting values such as X-dimension.

The available options are: mils (thousandths of an inch), mm (millimeters), or um (micrometers).

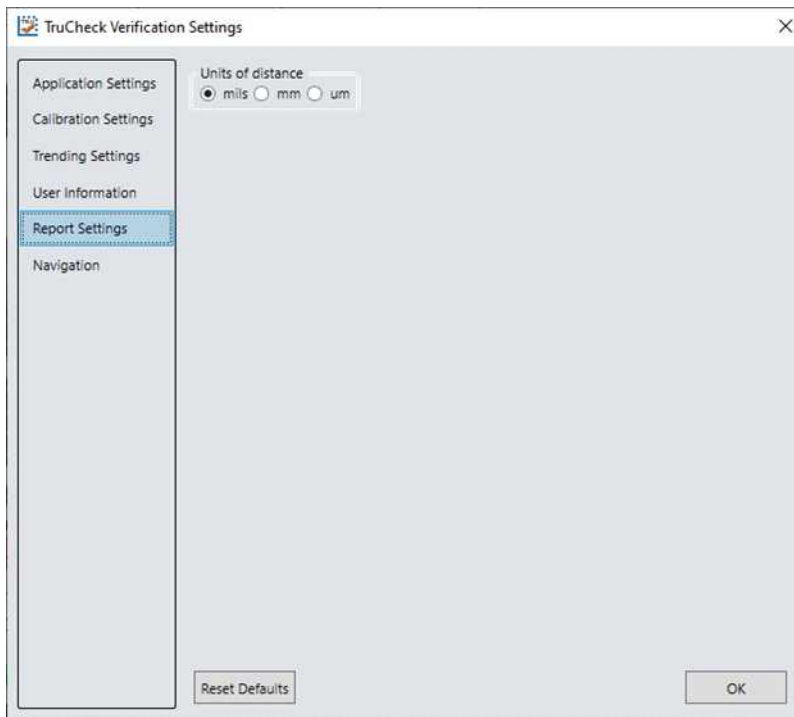

Navigation

The **Navigation** menu allows you to access certain options in the Setup Tool window to configure exporting results either through Setup Tool or FTP. The Navigation menu also provides a shortcut to enable or disable symbologies and to set up the verifier to verify multiple symbols in one verification. Click the View button to re-direct to the settings of each reporting option in Setup Tool.

Note: Maximize Setup Tool for the shortcuts to work. For more information on Setup Tool Panes, see the *Setup Tool Reference Manual*.

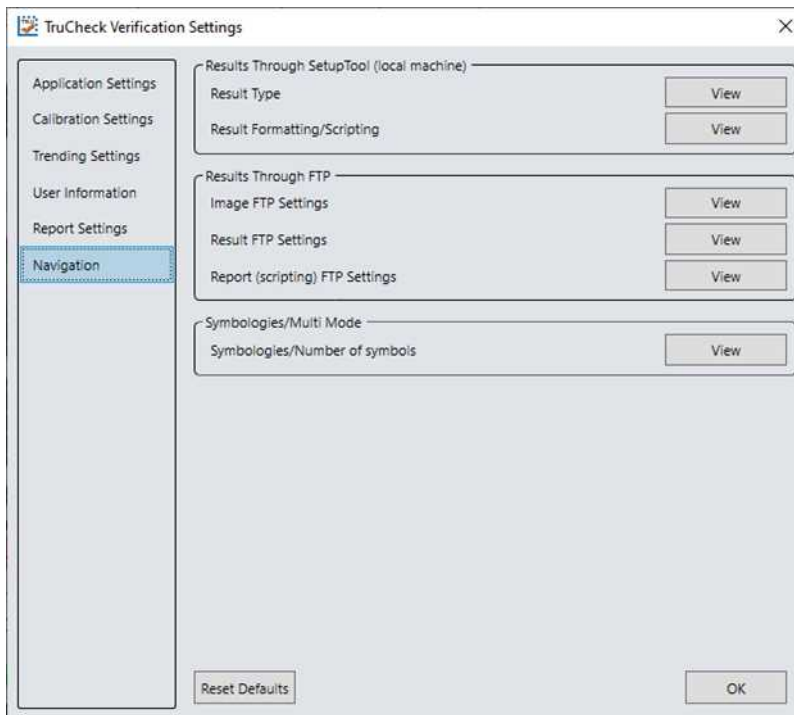

Results through Setup Tool (local machine)

In the **Results through Setup Tool (local machine)** section, two options are available to navigate to the Setup Tool windows to set up a scripting menu for exporting verification results either as an HTML or CSV report:

- Result Type
- Result Formatting/Scripting

For more information on the scripting options available for verification, see [Scripting on page 46](#). For more information on broad scripting options available in Setup Tool, refer to the **Scripting** section of the *DataMan Communications & Programming Guide*.

Result Type

Click **Result Type** to open the **Basic** tab in the **Format Data** application step in Setup Tool. Select **Script-Based Formatting** to enable scripting for export of verification data to CSV or to custom, script-defined format.

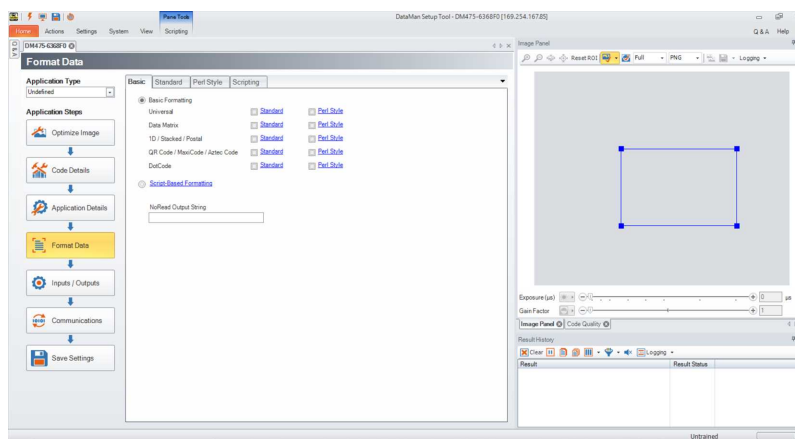

Result Formatting/Scripting

Click **Result Formatting/Scripting** to open the **Scripting** tab in the **Format Data** application step in Setup Tool. Create a script for outputting results or load a pre-written snippet in this window.

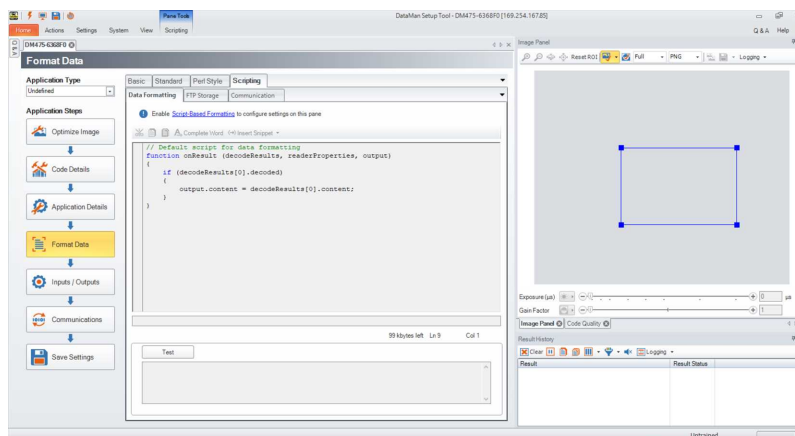

Results through FTP

In the **Results through FTP** section, three options are available to navigate to windows in the Setup Tool that connect to an FTP server for exporting verification:

- Image FTP Settings
- Result FTP Settings
- Report (scripting) FTP Settings

For more information, see [Setting Up FTP Transfer on page 48](#).

Image FTP Settings

Click **Image FTP Settings** to open the **Image Transfer** tab in the **Format Data** application step in Setup Tool. Enter information in this window to set up image export via FTP transfer.

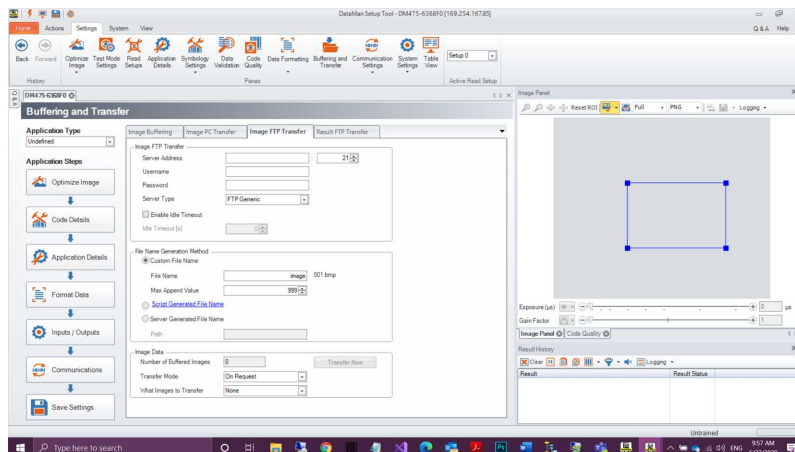

Result FTP Settings

Click **Result FTP Settings** to open the **Result FTP Transfer** tab in the **Format Data** pane in Setup Tool. Enter information in this window to export verification results via FTP transfer.

Note: Minimize TruCheck window and click Setup Tool window on the taskbar.

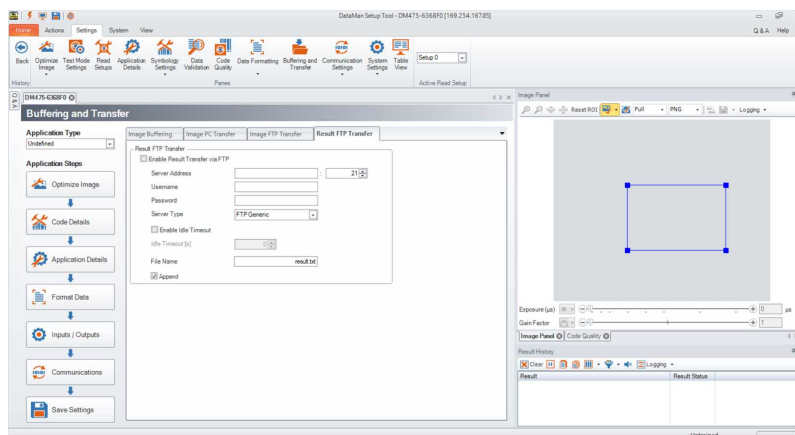

Report (scripting) FTP Settings

Click **Report FTP Settings** to open the **Report FTP Transfer** tab in the **Code Quality** application step in Setup Tool. Enter information in this window to export verification results via FTP Transfer.

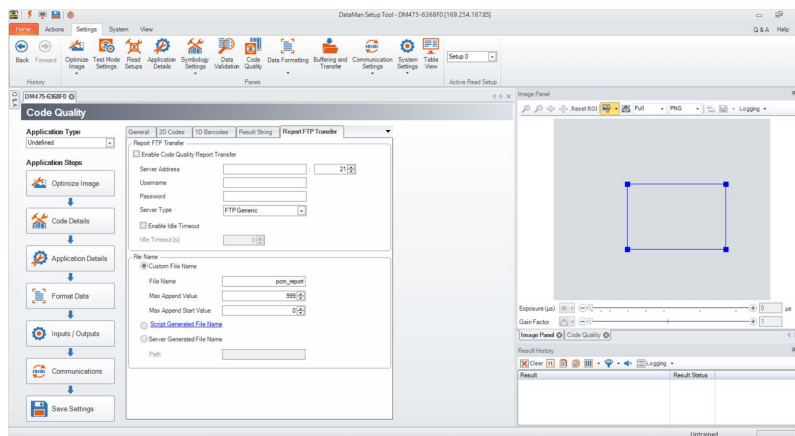

Symbologies/Multi Mode

Navigate to **Code Details** in Setup Tool that enable and disable symbology types and set up the verification of multiple symbols. For more information, see [Verifications of Multiple Symbols on page 21](#).

Symbologies/Number of Symbols

Select **Symbologies/Number of Symbols** to open the **Basic** tab in the **Code Details** application step in Setup Tool. Enable or disable any symbology types and enable multiple verification in this window.

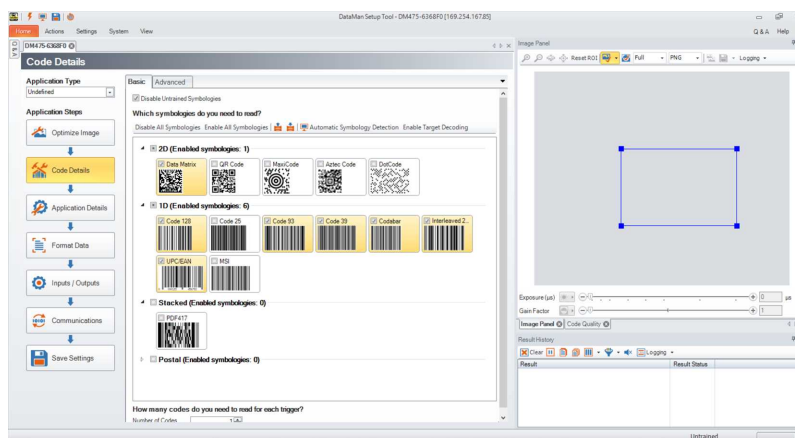

Scripting

Setup Tool allows you to customize a script for outputting results. Use Scripting to output a wide variety of information. For more details on customizing and making your own scripts, see **DataMan Communications and Programming Guide**. For verification results, Setup Tool provides two scripting templates listing the most common output formats for verification results in a CSV or an HTML report.

To enable scripting using the scripting templates:

1. Select the **Format Data** application step and the radio button to enable **Script-Based Formatting** on the **Basic** tab.

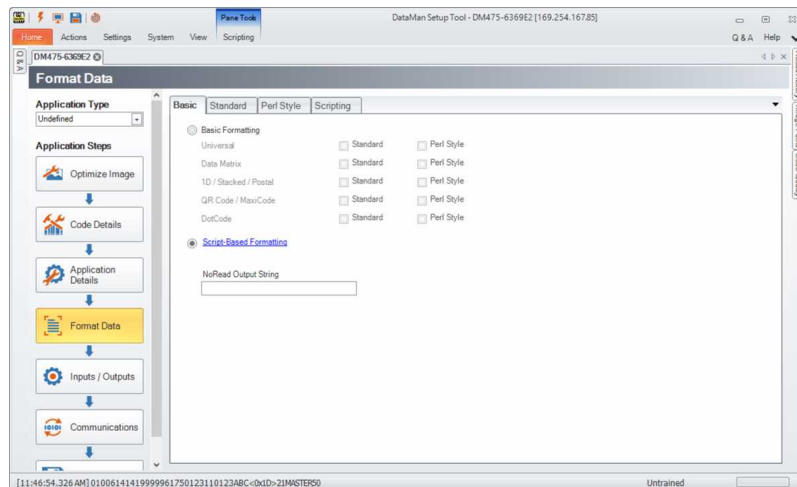

2. Select the **Scripting** tab on the ribbon menu.

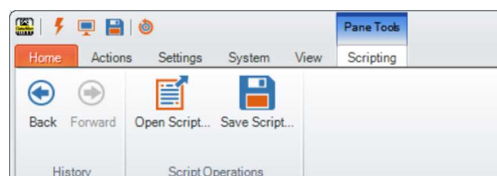

3. In the **Scripting** pane on the ribbon, click **Open Script**.
4. Navigate to the location of the Scripting templates: C:\Program Files (x86)\Cognex\DataMan\DataMan Software vx.x.x\Scripts. One scripting template generates results to a .CSV file and the other generates results to an .HTML file.
5. To save the output to a file, click the **Results History** window on the right.
6. In the **Logging** option, check the box to **Log all result codes to file system** and select the option for **Logging and reporting settings....**

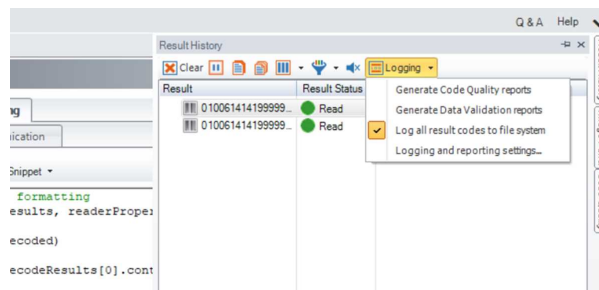

7. In the **Logging and reporting settings** menu, enter a file **Path** and **File Name** under the **Result Code** section. After providing a **File Name**, you must include either .CSV or .HTML depending on which template is selected.
8. Select **OK** to save and exit.

Note: If you do not include .CSV or .HTML after the file name, Setup Tool will not save the report correctly.

Result Code	
Path	C:\
File Name	sample report.html

You can customize the scripts to show more or less detail. For the full list of scripting options, see the **DataMan Communications and Programming Guide**.

Setting Up FTP Transfer

To configure the Dataman 475V to export verification results through FTP, change settings in Setup Tool to communicate with an external FTP server. Setup Tool can export information about:

- The image used for verification
- The result information provided from the **Result History** pane in Setup Tool
- The verification results provided in the **Code Quality** report.

To begin setting up an FTP server, configure an FTP server to communicate with Setup Tool. To set up the necessary information in the Setup Tool window, choose from three panes available for FTP transfer depending on what you would like to transfer:

- Image FTP Transfer
- Result FTP Transfer
- Report (scripting) FTP Transfer

The TruCheck window provides shortcuts to the three Setup Tool panes *Settings>Navigation>Results through FTP* menu. For more information, see [Results through FTP on page 44](#).

You can also click **Settings** in Setup Tool on the ribbon menu and open **Buffering and Transfer** to access the FTP settings.

Image FTP Transfer

To set up image transfer via FTP, fill in the **Server Address**, the **Username**, and the **Password** (if applicable) fields depending on the setup of your FTP server settings.

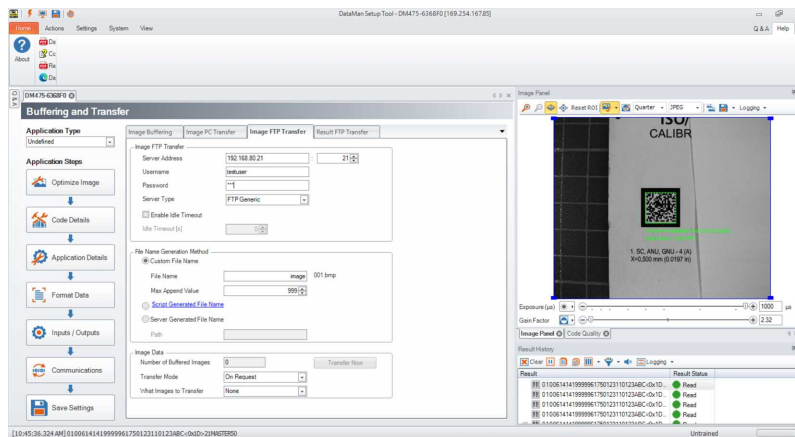

Result FTP Transfer

To set up result transfer via FTP, fill in the **Server Address**, the **Username**, and, if the software prompts you, the **Password** fields, depending on the setup of your FTP server. Selecting this option exports the results available in the **Result History** pane of Setup Tool for exporting to the FTP server. After all required fields are filled in, select the box next to **Enable Result Transfer via FTP**. Use the FTP Transfer setting when exporting verification results using scripting. In case of using one of the included CSV script snippets, include the .csv file extension at the end of the **File Name** field, for example *VerificationResults.csv*.

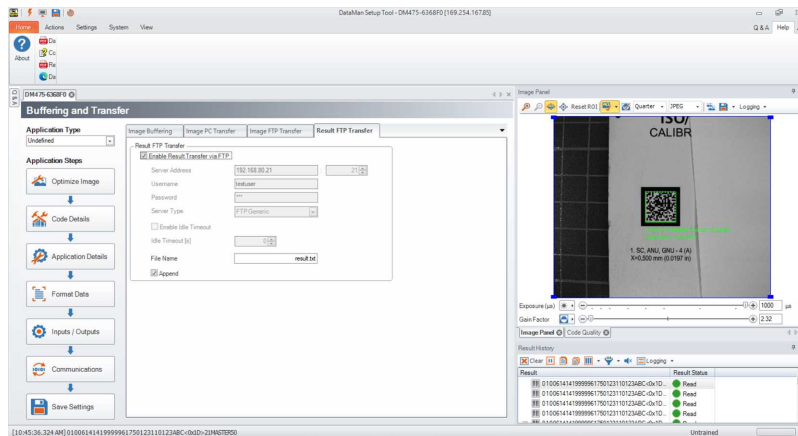

Report FTP Transfer

To set up report transfer via FTP, fill in the **Server Address**, the **Username**, and the **Password** (if applicable) fields depending on the setup of your FTP server settings. Selecting this option exports the **Code Quality** report information to an FTP server. After all required fields are filled in, select the box next to **Enable Code Quality Report Transfer**.

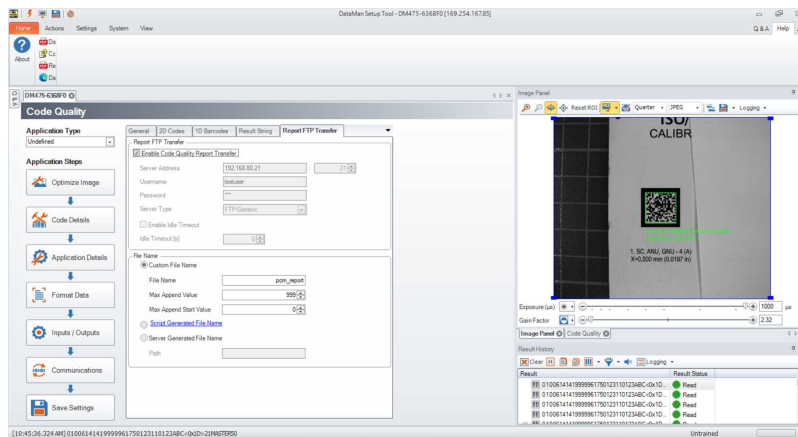

Grading Standards and their Parameters

Depending on the application two global quality grading standards are available for 2D symbols:

- ISO 15415
- ISO 15416
- ISO 29158 (AIM-DPM)

ISO/IEC 15415 Grading Parameters

The ISO/IEC 15415 standard specifies those measuring, evaluating, and grading methods and parameters, which determine the quality of 2D symbols, and identifies possible causes of symbol errors.

Unused Error Correction (UEC) is the percentage of the error correction capability that is available for additional incorrect modules. The assignment of grade is according to the following table:

UEC %	Grade
$62 \leq x$	A (4.0)
$50 \leq x < 62$	B (3.0)
$37 \leq x < 50$	C (2.0)
$25 \leq x < 37$	D (1.0)
$x < 25$	F (0)

Symbol Contrast (SC) represents the difference in reflectivity between the brightest module and the darkest module of the 2D code. Based on the difference a grade is assigned according to the following table:

SC%	Grade
$70 \leq x$	A (4.0)
$55 \leq x < 70$	B (3.0)
$40 \leq x < 55$	C (2.0)
$20 \leq x < 40$	D (1.0)
$x < 20$	F (0)

Modulation (MOD and RM) is a grade based on the amount of variability in reflectivity of the modules of the 2D code. A multi-step process is used to get the modulation grade.

1. First, the reflectivity of each module is compared to the global threshold and the overall symbol contrast according to the formula:

$$\text{MOD} = 2 * (\text{abs}(R - \text{GT})) / \text{SC}$$

The Global Threshold GT is the midpoint between the reflectance of the brightest module and the

reflectance of the darkest module.

2. Next, the grade level for each module is determined from the MOD value according to the following table:

MOD %	Grade
$50 \leq x$	A (4.0)
$40 \leq x < 50$	B (3.0)
$30 \leq x < 40$	C (2.0)
$20 \leq x < 30$	D (1.0)
$x < 20$	F (0)

The value of the grade for the Modulation parameter is the highest modulation level for which the modules meeting that level result in a theoretical Unused Error Correction grade of that level or higher. The module with the lowest MOD is reported as Contrast Uniformity (CU) in General Characteristics to facilitate conformance testing to the requirements of ISO/IEC 15426-2.

The RM parameter works in a similar way, except that for modules which are corrected as errors by the error correction, the MOD% is taken as 0 and counts as F in the final evaluation of the Modulation parameter grade according to the notional Unused Error Correction grade.

Axial Non-uniformity (ANU) represents the amount of “out of square” the modules are, that is, a measure of the overall aspect ratio of the symbol. For rectangular symbols which are not square, the ANU parameter reports the deviation from the aspect ratio of a square which the ANU considers "correct"..

ANU %	Grade
$x \leq 6$	A (4.0)
$6 < x \leq 8$	B (3.0)
$8 < x \leq 10$	C (2.0)
$10 < x \leq 12$	D (1.0)
$12 < x$	F (0)

Grid Non-uniformity (GNU) is the worst-case distance between the calculated center of a module and the ideal location for the center of the module based on perfectly evenly spaced modules. The calculated center of the module is determined using clock track edges in accordance with the reference decode algorithm. The value is reported as a percentage of a module size.

GNU %	Grade
≤ 38	A (4.0)
$38 < x \leq 50$	B (3.0)
$50 < x \leq 63$	C (2.0)
$63 < x \leq 75$	D (1.0)
$75 < x$	F (0)

Fixed Pattern Damage (FPD) is the overall grade for all the fixed pattern components. This grade is equal to the lowest grade of all the components listed.

The following is a list of components of the finder pattern for Data Matrix symbols. For QR Code symbols, the parameters described in **ISO 18004 QR Code Grading Parameters** are applicable, see [ISO 18004 QR Code Grading Parameters on page 55](#).

- **LLS (Left 'L' Side)** is a grade based on imperfections in the left 'L' side of the finder pattern. There are two checks required to pass.

First requirement:

- Stretch of 4 correct modules separate gaps
- Gaps are made up of 3 modules or less

Second requirement:

- Grade assigned according to the table is not fail.
 - The grade is calculated by the percentage of correct modules
- **BQZ (Bottom Quiet Zone)** is a grade based on imperfections in the quiet zone, which is a one-module area below the bottom 'L' side.
 - **BLS (Bottom 'L' Side)** is a grade based on imperfections in the bottom 'L' side of the finder pattern (see Left 'L' Side).
 - **LQZ (Left Quiet Zone)** is a grade based on imperfections in the quiet zone, which is a one-module area to the left of the left 'L' side. The grade is based on the percentage of modules, which are correct using the same grading table as for the 'L' sides.

% of incorrect modules	Grade
0	A (4.0)
$0 < x \leq 9$	B (3.0)
$9 < x \leq 13$	C (2.0)
$13 < x \leq 17$	D (1.0)
$17 < x$	F (0)

The LQZ grade is the highest modulation level in which the first (gap test) passes and the correct module percentage results in a grade of that level or higher.

- **TQZ (Top Quiet Zone)** is a grade based on imperfections in the quiet zone, which is a one-module area above the Top Clock Track.
 - **ULQZ (Upper Left Quiet Zone)** is the top quiet zone above the upper left quadrant. Used only for 2 and 4 quadrant symbols, this is the grade based on the segment of the quiet zone above the top clock track of the left quadrant.
 - **URQZ (Upper Right Quiet Zone)** is the top quiet zone above the upper right quadrant. Used only for 2 and 4 quadrant symbols, this is the grade based on the segment of the quiet zone above the top clock track of the right quadrant.
- **RQZ (Right Quiet Zone)** is a grade based on imperfections in the quiet zone, which is a one-module area to the right of the Right Clock Track.
 - **RUQZ (Right Quiet Zone to the right of the upper right quadrant):** Only for 2 and 4 quadrant symbols, this is the grade based on the segment of the quiet zone to the right of the upper right quadrant.
 - **RLQZ (Right Quiet Zone to the right of the lower right quadrant):** Only for 4 quadrant symbols, this is the grade based on the segment of the quiet zone to the right of the lower left quadrant.

- **TTR (Top Transition Ratio)** is a grade based on imperfections in the Top Clock Track, with relation to its adjoining quiet zone. Since the number of transitions in the quiet zone is zero, the ideal value for this parameter is zero. As the number of teeth in the clock track increases (larger symbols), more transitions in the quiet zone can be tolerated. More transitions in the clock track, which are really imperfections, also improve Top Transition Ratio. The grading scheme for this transition ratio is:

Transition Ratio %	Grade
$x \leq 6$	A (4.0)
$6 < x \leq 8$	B (3.0)
$8 < x \leq 10$	C (2.0)
$10 < x \leq 12$	D (1.0)
$12 < x$	F (0)

- **ULQTTR (Transition ratio for Upper Left Quadrant Top Clock Track):** Only for 4 quadrant symbols, this is the grade based on the clock track segment at the top of the upper left quadrant. For a 2 quadrant symbol, this is labeled LQTTR.
- **URQTTR (Transition ratio for Upper Right Quadrant Top Clock Track):** Only for 4 quadrant symbols, this is the grade based on the clock track segment at the top of the upper right quadrant. For a 2 quadrant symbol this is labeled RQTTR.
- **LLQTTR (Transition ratio for Lower Left Quadrant Top Clock Track):** Only for 4 quadrant symbols, this is the grade based on the clock track segment at the top of the lower left quadrant.
- **LRQTTR (Transition ratio for Lower Right Quadrant Top Clock Track):** Only for 2 and 4 quadrant symbols, this is the grade based on the clock track segment at the top of the lower right quadrant.
- **RTR (Right Transition Ratio):** Transition ratio for the right clock track in relation to the right quiet zone
- **ULQRTR (Transition ratio for Upper Left Quadrant Right Clock Track):** Only for 2 and 4 quadrant symbols, this is the grade based on the clock track segment to the right of the upper left quadrant. For a 2 quadrant symbol, this is labeled LQRTR
- **URQRTR (Transition ratio for Upper Right Quadrant Right Clock Track):** Only for 2 and 4 quadrant symbols, this is the grade based on the clock track segment to the right of the upper right quadrant. For 2 quadrant symbols, this is labeled RQRTR.
 - **LLQRTR (Transition ratio for Lower Left Quadrant Right Clock Track):** Only for 4 quadrant symbols, this is the grade based on the clock track segment to the right of the lower left quadrant.
 - **LRQRTR (Transition ratio for Lower Right Quadrant Right Clock Track):** Only for 4 quadrant symbols, this is the grade based on the clock track segment to the right of the lower right quadrant.
- **TCT (Top Clock Track)** is a grade based on imperfections in the top clock track. Some imperfections in the clock track can be tolerated. As a rule maintaining for a passing grade is that three out of every five modules on a consecutively rolling window of five modules must be correct. The value of the grade is the highest modulation level for which this test passes.
 - **ULQTCT (Top Clock Track for Upper Left Quadrant):** Only for 2 and 4 quadrant symbols, this is the grade based on the clock track segment at the top of the upper left quadrant. For 2 quadrant symbols this is labeled LQTCT.
 - **URQTCT (Top Clock Track for Upper Right Quadrant):** Only for 2 and 4 quadrant symbols, this is the grade based on the clock track segment at the top of the upper right quadrant. For 2 quadrant symbols this is labeled RQTCT.

- **LLQTCT (Top Clock Track for Lower Left Quadrant)**: Only for 4 quadrant symbols, this is the grade based on the clock track segment at the top of the lower left quadrant.
- **LRQTCT (Top Clock Track for Lower Right Quadrant)**: Only for 4 quadrant symbols, this is the grade based on the clock track segment at the top of the lower right quadrant.
- **RCT (Right Clock Track)** is a grade based on imperfection in the right clock track. Some imperfections in the clock track can be tolerated. As a rule maintaining for a passing grade is that three out of every five modules on a consecutively rolling window of five modules must be correct. The value of the grade is the highest modulation level for which this test passes..
 - **ULQRCT (Right Clock Track for Upper Left Quadrant)**: Only for 2 and 4 quadrant symbols, this is the grade based on the clock track segment to the right of the upper left quadrant. For 2 quadrant symbols, this is labeled LQRCT.
 - **URQRCT (Right Clock Track for Upper Right Quadrant)**: Only for 2 and 4 quadrant symbols, this is the grade based on the clock track segment to the right of the upper right quadrant. For 2 quadrant symbols, this is labeled RQRCT.
 - **LLQRCT (Right Clock Track for Lower Left Quadrant)**: Only for 4 quadrant symbols, this is the grade based on the clock track segment to the right of the lower left quadrant.
 - **LRQRCT (Right Clock Track for Lower Right Quadrant)**: Only for 4 quadrant symbols, this is the grade based on the clock track segment to the right of the lower right quadrant.
- **AG (Average Grade of Damage across many parts of the Finder Pattern)** is a grade that considers the accumulated effect of damage to several parts of the finder pattern. Five values are averaged together. One of these is the lowest of all the grades associated with all the clock track segments, namely TCT, TTR, TQZ and RCT, RTR, RQZ. The other four are LLS, BLS, LQZ, and BQZ. The average falls in the range of 0 through 4.0 and is given a grade according to the following:

Ave Grade	Grade
Equals 4.0	A (4.0)
$3.5 \leq x < 4.0$	B (3.0)
$3.0 \leq x < 3.5$	C (2.0)
$2.5 \leq x < 3$	D (1.0)
$x < 2.5$	F (0)

Note: The effect of the AG parameter is to lower the overall grade of symbols, which have several individual parameters at or near the same level. For example, with enough B grades in individual parameters, the overall grade may come out as a C grade rather than a B.

DECODE: Reports whether the 2D Symbol is decoded in accordance with the reference decode algorithm with the specified aperture.

It is possible to report decoded results, but for a failure to occur when decoding in accordance with the reference decode algorithm. In this case, the DECODE grade is F (0).

Contrast Uniformity (CU) is the value of MOD (modulation) for the worst-case module selected from a 2D Matrix symbol. This is useful for process control, as way of measuring the drift in reflectivity consistency, and for testing conformance to ISO/IEC 15426-2, which requires the modulation of a specific module within a conformance test symbol to be reported. This parameter is reported in General Characteristics.

ISO 18004 QR Code Grading Parameters

- **ULP** (Upper Left Pattern), **URP** (Upper Right Pattern) and **LLP** (Lower Left Pattern): three identical components of the finder pattern found in the respective corners of the QR Code symbol. Each finder pattern is composed of 7x7 dark modules, 5x5 light modules, and 3x3 dark modules. MicroQR code contains one finder pattern in the upper, left corner of the symbol.
- **HCT** (Horizontal Clock Track): The horizontal timing pattern consisting of a one module row of alternating dark and light modules.
- **VCT** (Vertical Clock Track): The vertical timing pattern consisting of a one module row of alternating dark and light modules.
- **ALP** (Alignment Pattern): The alignment pattern consists of 5x5 dark modules, 3x3 light modules, and a single central dark module. The alignment pattern is only present in QR Codes version 2 or higher.
- **FIB** (Format Information Block): The format information block is the encoded pattern containing information on symbol characteristics such as the Error Correction Level and the data mask pattern.
- **VIB** (Version Information Block): The version information block is the encoded pattern containing information on the symbol version. The version information block is only present on QR Codes version 7 or higher.

ISO 29158 (AIM-DPM) 2006 Grading Parameters

The ISO 29158 (AIM-DPM) method of grading Data Matrix symbols modifies the process of ISO-15415 grading parameters, and is appropriate for direct part marking (DPM) applications. In ISO 29158 (AIM-DPM) grading method, the image brightness is adjusted to produce an image of the symbol that fills most or all of the dynamic range of the imager, resulting in an image that is easy to see. The threshold between dark and light is calculated from the statistics of the image brightness histogram. Therefore, the measurements calculated by the AIM-DPM method differ from those of ISO 15415 significantly. Some of the parameters reported in ISO 15415 are changed completely and are renamed to avoid confusion between the two methods:

AIM-DPM Parameter Name	ISO 15415 Parameter Name	Summary of Change(s)
CC (Cell Contrast)	SC (Symbol Contrast) For more information, see ISO/IEC 15415 Grading Parameters on page 50	Made relative to light background.
CM or CMOD (Cell Modulation)	MOD (Modulation) For more information, see ISO/IEC 15415 Grading Parameters on page 50	Threshold calculated from statistics rather than the maximum and minimum reflectance. Grading scale range set to Mean of distribution, rather than maximum and minimum reflectance.
DDG (Distributed Damage Grade)	AG (Average Grade) For more information, see ISO/IEC 15415 Grading Parameters on page 50	Modulation overlay uses only A, B, D, and F levels, leaving out C level.
MR (Minimum Reflectance)	N/A	An absolute limit on SC of 5% added to temper the relative nature of CC and “catch” extremely low contrast symbols.

Fixed Pattern Damage grading parameters have the same names except for AG, but are functionally different. The global threshold and modulation grading scale are different. As symbols obtain a significantly higher grade according to AIM-DPM than ISO 15415, AIM-DPM grading is appropriate only when called for in an application specification.

AIM-DPM varies the size of the aperture until the symbol is decoded, then the grading is repeated with 50% and 80% aperture sizes. The higher result is reported as the final grade.

Note: When the reference decode algorithm fails to decode a symbol with both 50% and 80% aperture, the **DECODE** grade is “F” and a note is printed on the grade section of the report, even if the symbol is recognized and decoded with a different aperture size in an earlier phase of the grading procedure.

The following parameters are new or modified for AIM-DPM:

CC (Cell Contrast): Similar to SC, the relative contrast value between bars and spaces, taken from the means of the light and dark element $CC = (L_{mean} - D_{mean}) / L_{mean}$.

CC%	Grade
≥ 30%	4
≥ 25%	3
≥ 20%	2
≥ 15%	1
< 15%	0

CMOD (Cell Modulation): Similar to MOD in ISO 15415, CMOD measures the deviation in the reflectivity of dark and light elements. A range for each light and dark group is created from the global threshold to the mean reflectance of the elements. Each module is graded along the created range, then error correction capability is considered to “discount” the effect of one or a few elements with low values, and a final grade is computed for this parameter.

DDG (Distributed Damage Grade): Similar to AG in ISO 15415, DDG considers the effect of multiple segments of the fixed pattern having imperfections. Where multiple segments have a low grade, the effect of “distributed damage” is reflected in a lower grade for DDG than the lowest of the individual segments.

MR (Minimum Reflectance): This is a requirement for at least 5% reflectance difference between light and dark elements as a restraint on the purely relative CC parameter.

Decode: Decode grade A or F depending upon whether the reference decode algorithm succeeds in decoding the symbol with the required final aperture size.

Traditional (Non-Graded) Parameters

PCS

A way of Quantifying Contrast is Print Contrast Signal (PCS), an older and rarely used measure of contrast. Contrast is intended to quantify the difference between the bars and the spaces in reflectance. PCS is defined mathematically as:

$$PCS = (R_{max} - R_{min}) / R_{max}$$

PCS is equivalent to the percentage of the light background accounted for by the difference between the bars and spaces. PCS was defined as a measure of contrast the human eye perceives before and outside the context of measuring barcode contrast. The measurement is made relative to the brightness of the background. The darker (worse) the background color is, the higher (supposedly better) the value of PCS. Scanners are sensitive to the absolute difference between the reflectance of bars and spaces. Readers are especially sensitive to variations in contrast within the same scan.

MRD

Minimum Reflectance Difference (MRD) quantifies the minimum difference anywhere across the barcode. These worst-case bars and spaces are not necessary adjacent to one another.

ISO/IEC 15416 (ANSI x3.182) Grading Parameters

ISO/IEC 15416 is a standard for 1D codes. The ANSI parameters section lists each of the nine ANSI parameters, explain what is measured during successful or unsuccessful barcode reading, and summarizes the measurements based on all scans. For a review of the ANSI process given on each of your codes, check the ANSI Matrix for each code described below.

Note: Some of these parameters are average values over all of the scans, and the averages can skew or alter the apparent results.

When a code is not read, the scan is analyzed for apparent quiet zones. The ANSI analysis uses the bars and spaces between quiet zones.

1. EDGE: Edge Determination

Checks if the edge between bar and space can be detected and no false bars or spaces appear due to “splitting” of bars or ink splattered in spaces. If at least one scan results in a decoded barcode, the EDGE value is the number of bars and spaces in the code, not including quiet zones. If no scans result in a decoded barcode, the EDGE value shown is the number of bars and spaces found between quiet zones or apparent quiet zones on the scan on which the most bars and spaces were found.

2. RI/RD: Minimum Reflectance

Checks if the bars are sufficiently dark. The light reflectance is the maximum reflectivity found in the scan (lightest or best space), and the dark reflectivity is the minimum reflectivity found in the scan (darkest or best bar). The requirement is for the minimum reflectivity to be no more than half the maximum reflectivity. If this requirement is met, the grade is A, otherwise it is F. The values shown are the light reflectance and the dark element reflectance separated by a slash: RI/Rd.

3. SC: Symbol Contrast

Measures the contrast difference between the maximum reflectivity (lightest or best space) and the minimum reflectivity (darkest or best bar). The result is assigned a letter grade of A, B, C, D, or F, with A being the highest contrast. Note that Symbol Contrast is the difference between light and dark, and RI/Rd above checks the ratio of these values.

SC %	Grade
$x \geq 70$	A (4.0)
$70 > x \geq 55$	B (3.0)
$55 > x \geq 40$	C (2.0)
$40 > x \geq 20$	D (1.0)
$20 > x$	F (0)

4. MinEC: Minimum Edge Contrast

Checks if the contrast between adjacent bars and spaces is sufficiently high. If the difference between the light and dark elements is not significant, barcode readers fail to locate edges between bars and spaces.

Note: MinEC finds the worst-case contrast difference between each bar to space transition, whereas symbol contrast finds the best-case difference at any point across the barcode.

5. **MOD: Modulation**

Modulation measures the amount of available contrast that is manifested in the worst-case bar to space transition. Modulation checks the edge contrast as a fraction of the overall or best-case contrast measured in symbol contrast. Modulation is a measure of minimum edge contrast since most barcode readers employ adaptive thresholding circuits to detect transitions between bars and spaces. If all bars and spaces were the same brightness, the minimum edge contrast would be equivalent to the symbol contrast, resulting in 100% modulation. If some spaces are less bright than the brightest one, modulation is some fraction of the overall contrast. The percentage is assigned a letter grade.

MOD %	Grade
$x \geq 70$	A (4.0)
$70 > x \geq 60$	B (3.0)
$60 > x \geq 50$	C (2.0)
$50 > x \geq 40$	D (1.0)
$40 > x$	F (0)

6. **Def: Defects**

The worst-case change in reflectance within a single bar or space is a defect. The largest difference in reflectivity found in a single bar or space is measured as a percentage of the symbol contrast and assigned a letter grade. Defects measure breakups or voids within bars, ink spots in spaces, or even the grain of a substrate in spaces.

Def %	Grade
$x \leq 15$	A (4.0)
$15 < x \leq 20$	B (3.0)
$20 < x \leq 25$	C (2.0)
$25 < x \leq 30$	D (1.0)
$30 < x$	F (0)

7. **DCD: Decode**

The width of each bar and space are measured and used to interpret the data content of the barcode according to a specific mathematical formula appropriate for the barcode type. If the barcode cannot be decoded according to the formula, the accuracy of the bar and space widths are inadequate. The report shows the number of scans decoded over the number of scans taken, for example 8/10 means 8 out of 10 scans decoded.

8. **DEC: Decodability**

Determines how accurate the bar and space widths are and how easily the widths can be determined. A perfectly accurate barcode has 100 percent decodability, but decodability as low as 25 percent is often acceptable. Decodability is the percentage of the overall tolerance range for a bar or space width that is not used up by inaccuracies.

DEC %	Grade
$x \geq 62$	A (4.0)
$62 > x \geq 50$	B (3.0)
$50 > x \geq 37$	C (2.0)
$37 > x \geq 25$	D (1.0)
$25 > x$	F (0)

9. **QZ: Quiet Zone**

Quiet Zone refers to a dedicated amount of blank space on the left and right of the barcode. Each symbology specifies a minimum quiet zone.

Setting Up DataMan Setup Tool

This section provides information on the installation process of the DataMan Setup Tool and external triggers.

Reading your first Code

Follow the steps below to install and connect your verifier to the DataMan Setup Tool:

1. Download the latest version of the DataMan Setup Tool from <http://www.cognex.com/support/dataman> and follow the on-screen steps.
2. Check the DataMan **Release Notes** for a full list of system requirements found at C:\Program Files (x86)\Cognex\DataMan\DataMan Software v6.1.9\Documentation\English.
3. Connect the DataMan 475 verifier to your PC using the x-coded Ethernet cable and power the reader using the breakout cable.
4. Launch the DataMan Setup Tool and click **Refresh**.

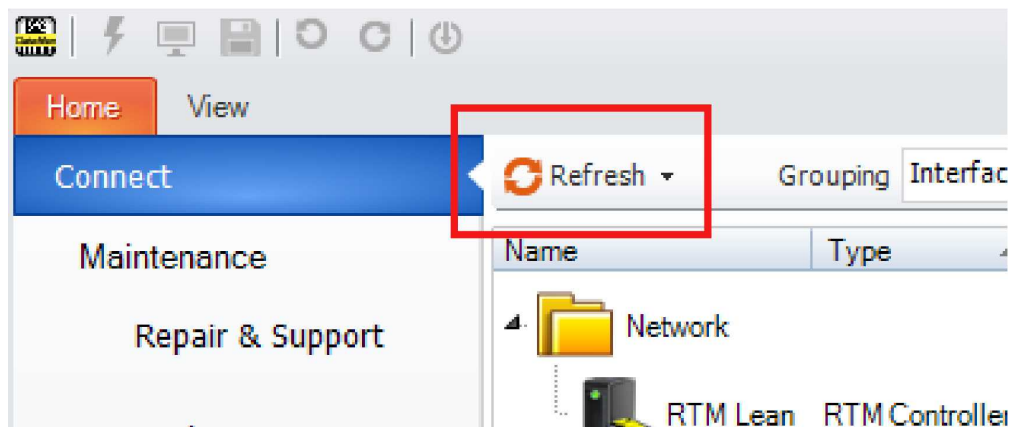

Note: Detected readers appear under **COM ports** or **Network devices**, or both.

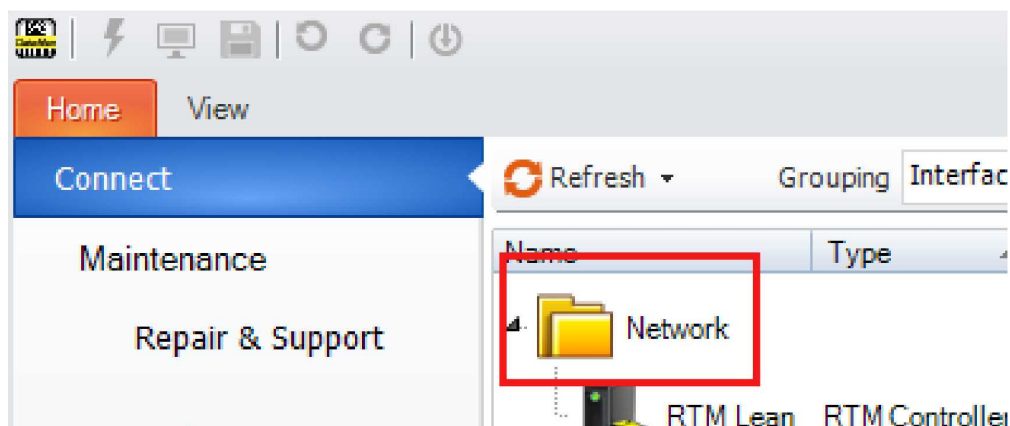

If the verifier does not appear in the list of devices, you can use either the **Add Device** or **Force Network Settings** options in the DataMan Setup Tool under **Repair & Support**. For more information, see the *DataMan Setup Tool Reference Manual*.

5. Select a verifier from the list and double click it or click **Connect**.

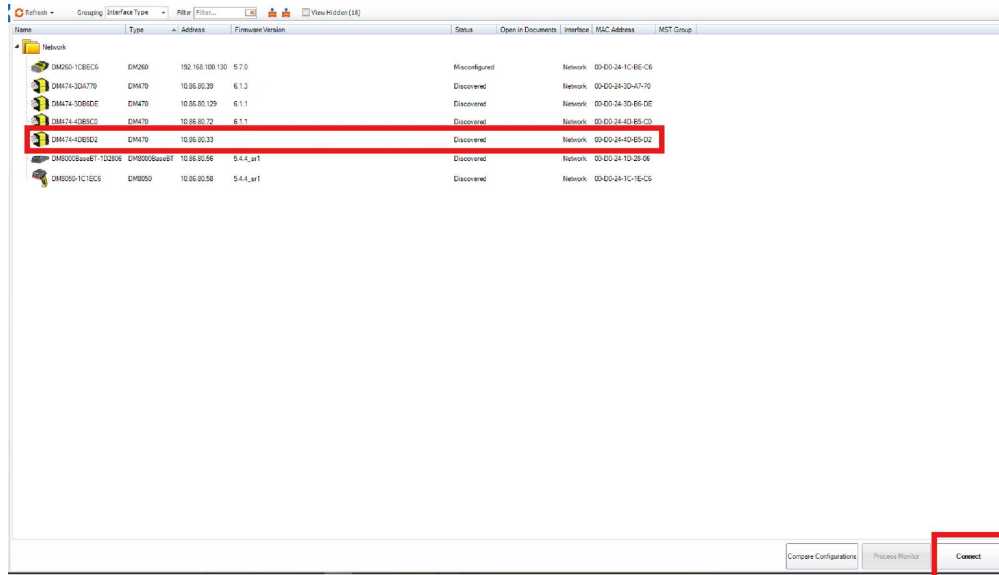

6. After connecting, the TruCheck window automatically opens.

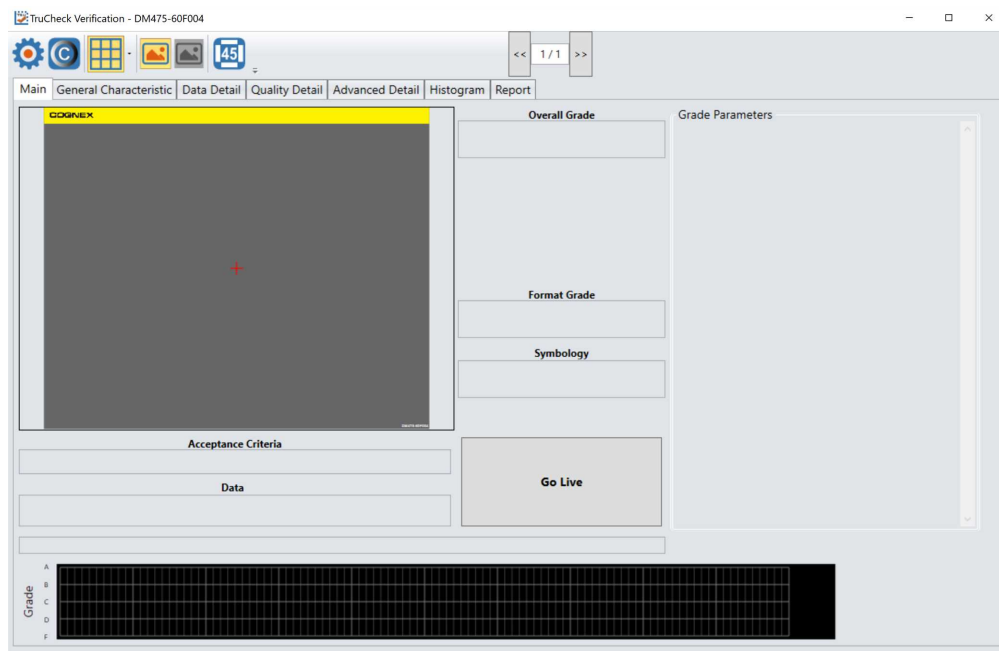

Note: If TruCheck window does not open or needs to be re-opened at any point during verification, select the TruCheck window icon under the **View menu on the ribbon bar** in Setup Tool.

Note: If you are running the DM475V at line speed, you may need to disconnect Setup Tool and obtain results through the device output interface.

WARNING: Do not stare into the beam when adding, removing, or changing cables. Cognex recommends to disconnect the reader from power whenever you make physical changes to it.

Follow the steps below to connect your reader to power and network:

CAUTION: I/O wiring or adjustments to I/O devices should be performed when the verifier is not receiving power.

CAUTION: The Ethernet cable shield must be grounded at the far end. Whatever this cable is plugged into (usually a switch or router) should have a grounded Ethernet connector. A digital voltmeter should be used to validate the grounding. If the far end device is not grounded, a ground wire should be added in compliance with local electrical codes.

1. Connect the I/O+RS232+24V cable to your reader.
2. Connect your reader through an Ethernet cable to your network for a network connection.
3. Connect the cable to a 24V power supply.

External Triggers

If you are using external triggering, you can use any of the following methods to trigger your DataMan 475 verifier:

- Press the trigger button on the reader.
- Send a pulse on the I/O cable:
 - Trigger + (orange or red)
 - Trigger - (black)
- Send a serial trigger command over the RS-232 connection connection.
- Press <CTRL-T> on the keyboard while the DataMan Setup Tool has the input focus.
- Click the **Trigger** button in the DataMan Setup Tool:

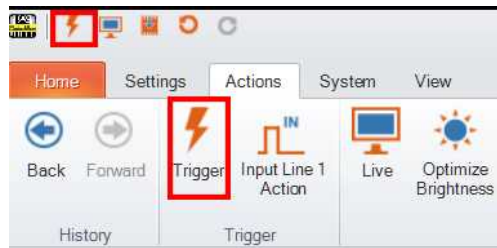

Cleaning and Maintenance

Cleaning the Verifier Housing

To clean the outside of the verifier housing, use a small amount of mild detergent cleaner or isopropyl alcohol on a cleaning cloth. Do not pour the cleaner directly onto the verifier housing.

 **CAUTION:** Do not attempt to clean any DataMan product with harsh or corrosive solvents, including lye, methyl ethyl ketone (MEK) or gasoline.

Cleaning the Verifier Lens Cover

To remove dust from the lens cover, use a pressurized air duster. The air must be free of oil, moisture or other contaminants that could remain on the lens cover. To clean the plastic window of the lens cover, use a small amount of isopropyl alcohol on a cleaning cloth. Do not scratch the plastic window. Do not pour the alcohol directly on the plastic window.

Compliance Information, Warnings and Notices

Precautions

To reduce the risk of injury or equipment damage, observe the following precautions when you install the Cognex product:

- The verifier is intended to be supplied by a UL or NRTL listed power supply with a 24VDC output rated for at least 2A continuous and a maximum short circuit current rating of less than 8A and a maximum power rating of less than 100VA and marked Class 2 or Limited Power Source (LPS). Any other voltage creates a risk of fire or shock and can damage the components. Applicable national and local wiring standards and rules must be followed.
- Route cables and wires away from high-current wiring or high-voltage power sources to reduce the risk of damage or malfunction from the following causes: over-voltage, line noise, electrostatic discharge (ESD), power surges, or other irregularities in the power supply.
- Do not install Cognex products where they are exposed to environmental hazards such as excessive heat, dust, moisture, humidity, impact, vibration, corrosive substances, flammable substances, or static electricity.
- Do not expose the image sensor to laser light. Image sensors can be damaged by direct, or reflected, laser light. If your application requires laser light that might strike the image sensor, use a lens filter at the corresponding laser wavelength. For suggestions, contact your local integrator or application engineer.
- Changes or modifications not expressly approved by the party responsible for regulatory compliance could void the user's authority to operate the equipment.
- Include service loops with cable connections.
- Ensure that the cable bend radius begins at least six inches from the connector. Cable shielding can be degraded or cables can be damaged or wear out faster if a service loop or bend radius is tighter than 10X the cable diameter.
- This device should be used in accordance with the instructions in this manual.
- All specifications are for reference purposes only and can change without notice.

Regulations/Conformity

Note: For the most current CE declaration and regulatory conformity information, see the Cognex support site: cognex.com/support.

DataMan 475 verifiers have Regulatory Model R00062, Label Light (DMV-475V-LBL-0200) has Accessory Model 50162, and meet or exceed the requirements of all applicable standards organizations for safe operation. However, as with any electrical equipment, the best way to ensure safe operation is to operate them according to the agency guidelines that follow. Please read these guidelines carefully before using your device.

Safety and Regulatory	
Manufacturer	Cognex Corporation One Vision Drive Natick, MA 01760 USA
USA	TÜV SÜD SCC/NRTL OSHA Scheme for UL/CAN 61010-1. FCC Part 15, Class A This equipment has been tested and found to comply with the limits for a Class A digital device, pursuant to part 15 of the FCC Rules. These limits are designed to provide reasonable protection against harmful interference when the equipment is operated in a commercial environment. This equipment generates, uses, and can radiate radio frequency energy and, if not installed and used in accordance with the instruction manual, may cause harmful interference to radio communications. Operation of this equipment in a residential area is likely to cause harmful interference in which case the user will be required to correct the interference at his own expense.
Canada	TÜV SÜD SCC/NRTL OSHA Scheme for UL/CAN 61010-1. ICES-003, Class A This Class A digital apparatus complies with Canadian ICES-003. Cet appareil numérique de la classe A est conforme à la norme NMB-003 du Canada.
Europe	DM475 (Regulatory Model R00062) Label Light (DMV-475V-LBL-0200) (Accessory Model 50162) The CE mark on the product indicates that the system has been tested to and conforms to the provisions noted within the 2014/30/EU Electromagnetic Compatibility Directive and the 2011/65/EU RoHS Directive. For further information, please contact: Cognex Corporation, One Vision Drive, Natick, MA 01760, USA. Cognex Corporation shall not be liable for use of our product with equipment (i.e., power supplies, personal computers, etc.) that is not CE.
Korea	A급 기기(업무용 방송통신기자재): 이 기기는 업무용(A급) 전자파적합기기로서 판매자 또는 사용자는 이 점을 주의하시기 바라며, 가정외의 지역에서 사용하는 것을 목적으로 합니다. DM475 (Regulatory Model R00062) Label Light (DMV-475V-LBL-0200) (Accessory Model 50162)
International Product Safety	Conforms to IEC 61010-1, CAN/CSA-C22.2 No. 61010-1:2012 + UPD No. 1:2015-07, UL 61010-1:2012 + R:2015-07, UL 61010-1:2012 + R:2015-07, EN 61010-1:2010.
CB	TÜV SÜD, IEC/EN 61010-1. CB report available upon request.

For European Community Users

Cognex complies with Directive 2012/19/EU OF THE EUROPEAN PARLIAMENT AND OF THE COUNCIL of 4 July 2012 on waste electrical and electronic equipment (WEEE).

This product has required the extraction and use of natural resources for its production. It may contain hazardous substances that could impact health and the environment, if not properly disposed.

In order to avoid the dissemination of those substances in our environment and to diminish the pressure on the natural resources, we encourage you to use the appropriate take-back systems for product disposal. Those systems will reuse or recycle most of the materials of the product you are disposing in a sound way.



The crossed out wheeled bin symbol informs you that the product should not be disposed of along with municipal waste and invites you to use the appropriate separate take-back systems for product disposal.

If you need more information on the collection, reuse, and recycling systems, please contact your local or regional waste administration.

You may also contact your supplier for more information on the environmental performance of this product.

