

COGNEX

MX-1000 Series Quick Reference Guide

2021 April 14
Revision: 5.7.7SR5.6

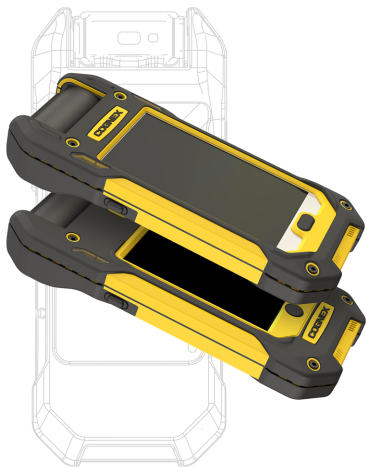

Precautions

To reduce the risk of injury or equipment damage, observe the following precautions when you install the Cognex product:

- Route cables and wires away from high-current wiring or high-voltage power sources to reduce the risk of damage or malfunction from the following causes: over-voltage, line noise, electrostatic discharge (ESD), power surges, or other irregularities in the power supply.
- Changes or modifications not expressly approved by the party responsible for regulatory compliance could void the user's authority to operate the equipment.
- Ensure that the cable bend radius begins at least six inches from the connector. Cable shielding can be degraded or cables can be damaged or wear out faster if a service loop or bend radius is tighter than 10X the cable diameter.
- This device should be used in accordance with the instructions in this manual.
- All specifications are for reference purposes only and can change without notice.

Symbols

The following symbols indicate safety precautions and supplemental information:



WARNING: This symbol indicates a hazard that could cause death, serious personal injury or electrical shock.



CAUTION: This symbol indicates a hazard that could result in property damage.



Note: This symbol indicates additional information about a subject.



Tip: This symbol indicates suggestions and shortcuts that might not otherwise be apparent.

MX-1000 Layout

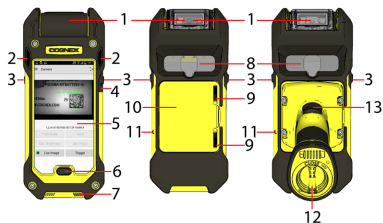











Layout



| | |
|----|------------------------------------|
| 1 | Scanner head (rotatable by 45°) |
| 2 | Indicator LEDs |
| 3 | Side trigger buttons |
| 4 | Power button |
| 5 | Touch screen |
| 6 | Home button |
| 7 | Speaker vents |
| 8 | Recessed area for mobile camera |
| 9 | Slider to lock battery cover |
| 10 | Battery cover |
| 11 | Lanyard hook |
| 12 | End cap of pistol grip* |
| 13 | Trigger button on the pistol grip* |

*Pistol grip is optional

MX-1000 Series Accessories

| Accessory | | |
|--|--|---|
| Battery for reader (3120 mAh) | DMA-MTBATTERY-01 |  |
| Battery for pistol grip accessory (3070 mAh) | DMA-HHBATTERY-01 |  |
| Pistol grip | DMA-GRIP-01 |  |
| <p>i Note: The grip features its own trigger button and an additional battery which can be charged via the charging station.</p> | | |
| Belt holster | DMA-HOLSTER-01 DMA-HOLSTER-02 |  |
| Charging station (inductive) | DMA-MTBASE-US DMA-MTBASE-EU |  |
| Charging station (non-inductive) | DMA-MTBASEP-US DMA-MTBASEP-EU |  |
| Multi-device charger | DMA-MTBASE4-US DMA-MTBASE4-EU DMA-MTBASE4BKT-US DMA-MTBASE4BKT-EU |  |
| Multi-battery charger | DMA-MBC-US DMA-MBC-EU |  |
| Wireless car charger | DMA-VMCHARGER-00 |  |
| Power supply for charging station 24V/24W | DMA-24VPWR-US DMA-24VPWR-EU |  |

Accessory

| | | |
|---|---|---|
| <p>USB Type-C battery charger kits</p> <ol style="list-style-type: none"> 1. USB Type-C Battery Cover (DMA-MXUSB-00) + USB Type-C 3Amp Car Charger (DMA-MXUSB-CHARGER) 2. USB Type-C Battery Cover (DMA-MXUSB-00) + Handstrap (DMA-MXSTRAP-00) 3. USB Type-C Battery Cover (DMA-MXUSB-00) + USB Type-C 3Amp Car Charger (DMA-MXUSB-CHARGER) + Handstrap (DMA-MXSTRAP-00) | <ol style="list-style-type: none"> 1. DMA-MXUSB-01 2. DMA-MXUSB-02 3. DMA-MXUSB-03 |  |
| <p>Passive car holder¹</p> | <p>DMA-VMHOLDER-00</p> |  |

¹ Using or storing the device outside of the recommended temperature ranges may damage or reduce the lifespan of the battery. Leaving the MX Series Mobile Terminal with a mobile device in direct sunlight for an extended amount of time can raise the temperature above the recommended limit.

Accessory

Top Cover

DMA-COVERKIT-S6
DMA-COVERKIT-S7
DMA-COVERKIT-S8
DMA-COVERKIT-S9
DMA-COVERKIT-I5
DMA-COVERKIT-I6
DMA-COVERKIT-S4
DMA-COVERKIT-S5
DMA-COVERKIT-J3
DMA-COVERKIT-J327
DMA-COVERKIT-J330
DMA-COVERKIT-A3
DMA-COVERKIT-X4
DMA-COVERKIT-N42
DMA-COVERKIT-s10e
DMA-COVERKIT-IX

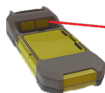

LASER LIGHT - DO NOT STARE INTO BEAM
CLASS II LASER PRODUCT (500mW max)
CLASSIFIED PER IEC 60825-1 Ed 3, 2014

Complies with FDA performance
standards for laser products except
for deviations pursuant to Laser
Notice No. 95, dated June 24, 2007.



Dimensional Drawings

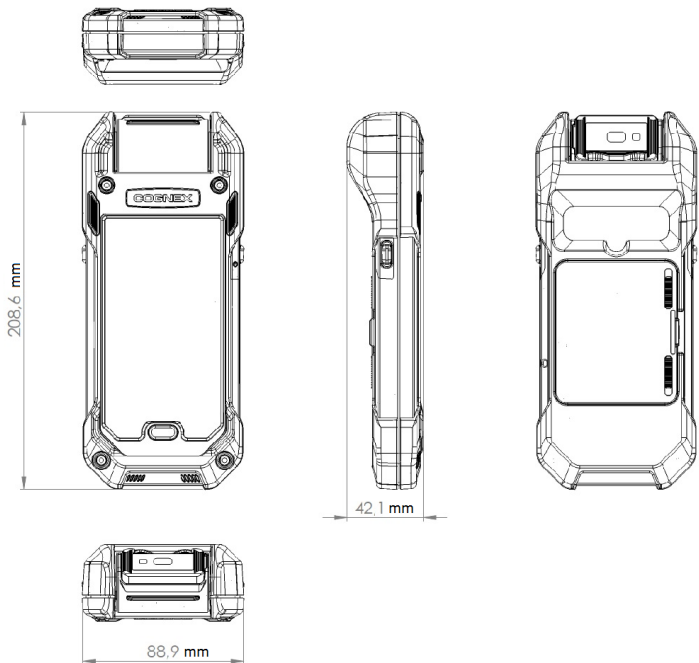

Field of View and Reading Distances

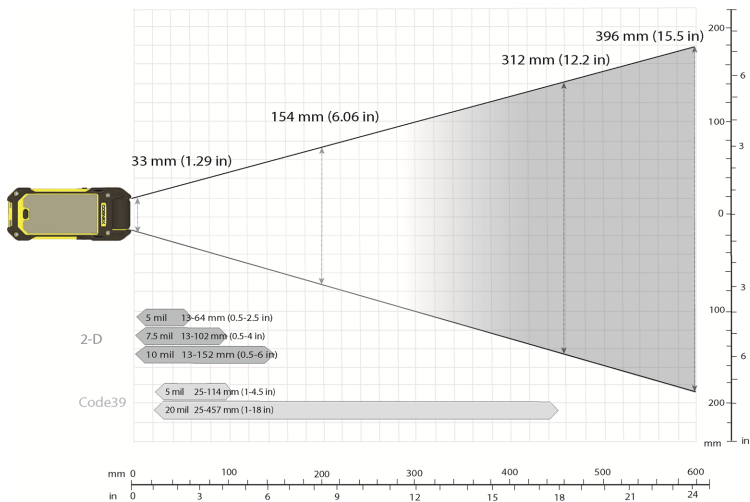

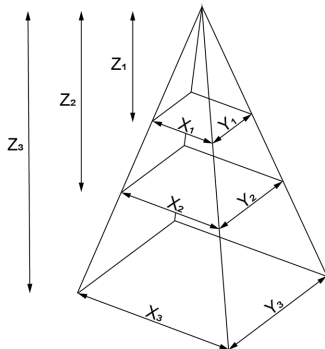

| Working Distance | Horizontal Values | Vertical Values |
|------------------------|---------------------------|---------------------------|
| $Z_1 = 15 \text{ mm}$ | $X_1 = 6.4 \text{ mm}$ | $Y_1 = 4.09 \text{ mm}$ |
| $Z_2 = 210 \text{ mm}$ | $X_2 = 148.31 \text{ mm}$ | $Y_2 = 94.67 \text{ mm}$ |
| $Z_3 = 420 \text{ mm}$ | $X_3 = 301.14 \text{ mm}$ | $Y_3 = 192.22 \text{ mm}$ |

| Distances in mm / 1D min code | | Distances in mm / 2D min code | |
|-------------------------------|-------|-------------------------------|-------|
| 25-105 | 5 MIL | 15-70 | 5 MIL |

| Distances in mm / 1D min code | | Distances in mm / 2D min code | |
|-------------------------------|---------|-------------------------------|---------|
| 25-158 | 7.5 MIL | 15-105 | 7.5 MIL |
| 25-210 | 10 MIL | 15-140 | 10 MIL |
| 25-420 | 20 MIL | 15-275 | 20 MIL |



Note: Due to tolerances, ranges can vary by +/- 5 mm for small codes to +/- a couple of centimeters for large codes.

Assembling the Reader

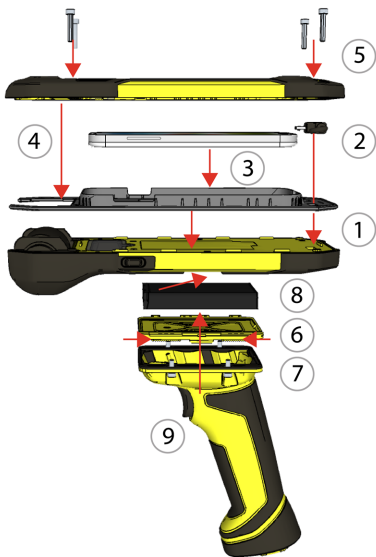



1. Place the rubber insert on the base unit.
2. Plug the USB cable into the base unit.
3. Put the mobile device on the rubber insert and connect it to the base unit with the USB cable.
4. Attach the top cover.
5. Tighten the screws to fix the top cover.
6. Open the back cover to take out the reader battery.
7. Plug the pistol grip cable into the grip connector.
8. Insert the reader battery.
9. Assemble the reader with the pistol grip and tighten the screws.

i **Note:** For details, see the *MX-1000 Reference Manual*.
For a list of supported mobile devices, please contact Cognex.

Installation

Installation procedures and specifications are presented in detail in the *MX-1000 Reference Manual*, which is installed with the DataMan Setup Tool. From the Windows Start menu, select the following to access the manual: *All Programs > Cognex > DataMan Software v6.1.0 > Documentation*.

 **Note:** If a standard component is missing or damaged, immediately contact your Cognex Authorized Service Provider (ASP) or Cognex Technical Support.

 **CAUTION:** All cable connectors are keyed to fit the connectors on the reader. Do not force the connections or damage may occur.

Install Software and Documentation and Connect the Reader

To configure an MX-1000 reader, the DataMan Setup Tool software must be installed on a networked PC. The DataMan Setup Tool is available from the DataMan support site: <http://www.cognex.com/support/dataman>.

 **Note:** The DataMan Setup Tool only works if the DataMan Quick Setup is installed on the mobile device. For further details, see the *MX-1000 User Guide*.

1. After installing the software, connect the MX-1000 to your PC.
2. Launch the DataMan Setup Tool and click **Refresh**.
3. Select your MX-1000 reader from the list and click **Connect**.

MX-1000 Specifications

| Specification | MX-1100 Imager |
|---|--|
| Weight | 510 g (675 g with pistol grip) |
| Operating Temperature | 0°C — +40°C (+32°F — +104°F) |
| Storage Temperature | -40°C — +60°C (-40°F — +140°F) |
| Charging Temperature | 0°C — +35°C (+32°F — +95°F) |
| Maximum Humidity | < 95% (non-condensing) |
| Environmental | IP65 |
| Codes | 1-D: UPC/EAN/JAN, Codabar, Interleaved 2 of 5, Code 39, Code 128, Code 93, Pharmacode, GS1 DataBar, PDF417, Micro PDF417 2-D: Data Matrix, QR Code, and MicroQR Code, DotCode and postal code |
| Power Supply Requirements | Battery power |
| Expected operating time for typical scan batches (400 scan per hour) with a fully charged battery | 12 hours |

Imager Specifications

| Specification | MX-1000 Imager |
|---------------------------|---|
| Image Sensor | 1/3 inch CMOS |
| Image Sensor Properties | 6.0 μ m square pixels |
| Image Resolution (Pixels) | 752 x 480 global shutter sensor |
| Lens Type | 6.2 mm with different focal positions for MX-1000 and MX-1100, M12 lens with IR blocking filter |

LED Wavelengths

The following table shows LED types and the related wavelengths:

| LED | λ [nm] |
|-----|----------------|
| RED | 617 |

Charging Station Specifications

| Specification | Charging Station |
|---------------------------|---|
| Weight | 380 g |
| Operating Temperature | 0°C — +40°C (+32°F — +104°F) |
| Storage Temperature | -40°C — +60°C (-40°F — +140°F) |
| Maximum Humidity | 95% (non-condensing) |
| Power Supply Requirements | 24 V, 24 W maximum LPS or NEC Class 2 power supply 0.5A (inductive) and 1A (non-inductive) |

Compliance Statements

The MX-1000 has Regulatory Model 1AA7 (inductive) and Regulatory Model R00078 (non-inductive), and meets or exceeds the requirements of all applicable standards organizations for safe operation. However, as with any electrical equipment, the best way to ensure safe operation is to operate them according to the agency guidelines that follow. Please read these guidelines carefully before using your device.

The following specifications apply to the MX-1000 readers:



| Regulator | Specification |
|--------------------|--|
| USA | FCC 47 CFR Part 15, Subpart B Class A |
| Canada | ICES-003, Class A |
| European Community | EN55022, Class A EN55024 |
| Australia | AS/NZS 3548 Class B |
| Japan | VCCI V-2/2015.04 |
| Korea | IEC/CISPR 22 IEC/CISPR 24 KN22 KN24 Registration number: MSIP-REM-CGX-DM9050 |



Note: For the most current CE declaration and regulatory conformity information, see the Cognex support site: cognex.com/support.

Safety and Regulatory

| | |
|----------------------------------|--|
| European Compliance CE | This is a class A product. In a domestic environment this product may cause radio interference in which case the user may be required to take adequate measures. This equipment complies with the essential requirements of EU Directive 2014/30/EU. Declarations are available from your local representative. |
|----------------------------------|--|

| Safety and Regulatory | |
|--|---|
| FCC Class A Compliance Statement  | This equipment has been tested and found to comply with the limits for a Class A digital device, pursuant to part 15 of the FCC Rules. These limits are designed to provide reasonable protection against harmful interference when the equipment is operated in a commercial environment. This equipment generates, uses, and can radiate radio frequency energy and, if not installed and used in accordance with the instruction manual, may cause harmful interference to radio communications. Operation of this equipment in a residential area is likely to cause harmful interference in which case the user will be required to correct the interference at his own expense. |
| Canadian Compliance  | This Class A digital apparatus complies with Canadian ICES-003. Cet appareil numérique de la classe A est conforme à la norme NMB-003 du Canada. MX-1000: Regulatory Model 1AA7 (inductive), R00078 (non-inductive) |

For European Union Users

Cognex complies with Directive 2012/19/EU OF THE EUROPEAN PARLIAMENT AND OF THE COUNCIL of 4 July 2012 on waste electrical and electronic equipment (WEEE).

This product has required the extraction and use of natural resources for its production. It may contain hazardous substances that could impact health and the environment, if not properly disposed.

In order to avoid the dissemination of those substances in our environment and to diminish the pressure on the natural resources, we encourage you to use the appropriate take-back systems for product disposal. Those systems will reuse or recycle most of the materials of the product you are disposing in a sound way.



The crossed out wheeled bin symbol informs you that the product should not be disposed of along with municipal waste and invites you to use the appropriate separate take-back systems for product disposal.

If you need more information on the collection, reuse, and recycling systems, please contact your local or regional waste administration.

You may also contact your supplier for more information on the environmental performance of this product.

Compliance Statements: Wireless Charging Station

The Wireless Charging Station has Regulatory Model 1ABA (inductive) and Regulatory Model R00080 (non-inductive), and meets or exceeds the requirements of all applicable standards organizations for safe operation. However, as with any electrical equipment, the best way to ensure safe operation is to operate them according to the agency guidelines that follow. Please read these guidelines carefully before using your device.

| Regulator | Specification |
|--------------------|---------------------------------------|
| USA | FCC 47 CFR Part 15, Subpart B Class A |
| Canada | ICES-003, Class A |
| European Community | EN55032, Class A EN55024 |
| Australia | AS/NZS 3548 Class A |
| Japan | VCCI V-3/2015.04 Class A |

| Regulator | Specification |
|-----------|---|
| Korea | IEC/CISPR 22 IEC/CISPR 24 KN22 KN24 Registration number: MSIP-REM-CGX-DMA-MT-BASE |

For European Union Users

Cognex complies with Directive 2012/19/EU OF THE EUROPEAN PARLIAMENT AND OF THE COUNCIL of 4 July 2012 on waste electrical and electronic equipment (WEEE).

This product has required the extraction and use of natural resources for its production. It may contain hazardous substances that could impact health and the environment, if not properly disposed.

In order to avoid the dissemination of those substances in our environment and to diminish the pressure on the natural resources, we encourage you to use the appropriate take-back systems for product disposal. Those systems will reuse or recycle most of the materials of the product you are disposing in a sound way.



The crossed out wheeled bin symbol informs you that the product should not be disposed of along with municipal waste and invites you to use the appropriate separate take-back systems for product disposal.

If you need more information on the collection, reuse, and recycling systems, please contact your local or regional waste administration.

You may also contact your supplier for more information on the environmental performance of this product.

Safety and Regulatory

European Compliance



This is a Class A product. In a domestic environment this product may cause radio interference in which case the user may be required to take adequate measures.
This equipment complies with the essential requirements of EU Directive 2014/30/EU. Declarations are available from your local representative.

FCC Class A Compliance
Statement

FCC Part 15, Class A
This equipment has been tested and found to comply with the limits for a Class A digital device, pursuant to part 15 of the FCC Rules. These limits are designed to provide reasonable protection against harmful interference when the equipment is operated in a commercial environment. This equipment generates, uses, and can radiate radio frequency energy and, if not installed and used in accordance with the instruction manual, may cause harmful interference to radio communications. Operation of this equipment in a residential area is likely to cause harmful interference in which case the user will be required to correct the interference at his own expense.

Canadian Compliance

This Class A digital apparatus complies with Canadian ICES-003. Cet appareil numérique de la classe A est conforme à la norme NMB-003 du Canada.

中国大陆RoHS (Information for China RoHS Compliance)

根据中国大陆《电子信息产品污染控制管理办法》(也称为中国大陆RoHS), 以下部份列出了本产品中可能包含的有毒有害物质或元素的名称和含量。



Table of toxic and hazardous substances/elements and their content, as required by China's management methods for controlling pollution by electronic information products.

| Part Name 部件名称 | Hazardous Substances 有害物质 | | | | | |
|--|---------------------------|-------------------|-------------------|--------------------------------------|--|--|
| | Lead (Pb) 铅 | Mercury (Hg) 汞 | Cadmium (Cd) 镉 | Hexavalent Chromium (Cr (VI)) 六价铬 | Polybrominated biphenyls (PBB) 多溴联苯 | Polybrominated diphenyl ethers (PBDE) 多溴二苯醚 |
| Regulatory Model 1AA7 Regulatory Model 1ABA | X | O | O | O | O | O |
| <p>This table is prepared in accordance with the provisions of SJ/T 11364. 这个标签是根据SJ/T 11364的规定准备的。</p> <p>O: Indicates that said hazardous substance contained in all of the homogeneous materials for this part is below the limit requirement of GB / T26572 - 2011. 表示本部件所有均质材料中含有的有害物质低于GB / T26572 - 2011的限量要求。</p> <p>X: Indicates that said hazardous substance contained in at least one of the homogeneous materials used for this part is above the limit requirement of GB / T26572 - 2011. 表示用于本部件的至少一种均质材料中所含的有害物质超过GB / T26572 - 2011的限制要求。</p> | | | | | | |

Copyright © 2020
Cognex Corporation. All Rights Reserved.