

DataMan[®] 50 Quick Reference Guide

2021 April 14
Revision: 5.7.7SR5.5



Precautions

To reduce the risk of injury or equipment damage, observe the following precautions when you install the Cognex product:

- Route cables and wires away from high-current wiring or high-voltage power sources to reduce the risk of damage or malfunction from the following causes: over-voltage, line noise, electrostatic discharge (ESD), power surges, or other irregularities in the power supply.
- Changes or modifications not expressly approved by the party responsible for regulatory compliance could void the user's authority to operate the equipment.
- Ensure that the cable bend radius begins at least six inches from the connector. Cable shielding can be degraded or cables can be damaged or wear out faster if a service loop or bend radius is tighter than 10X the cable diameter.
- This device should be used in accordance with the instructions in this manual.
- All specifications are for reference purposes only and can change without notice.

Symbols

The following symbols indicate safety precautions and supplemental information:



WARNING: This symbol indicates a hazard that could cause death, serious personal injury or electrical shock.



CAUTION: This symbol indicates a hazard that could result in property damage.



Note: This symbol indicates additional information about a subject.



Tip: This symbol indicates suggestions and shortcuts that might not otherwise be apparent.

Product Overview

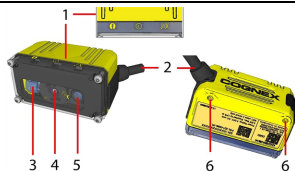



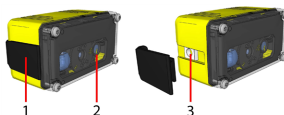



1	Status LEDs: - YELLOW - GREEN - RED
2	Cable
3	Internal illumination
4	3-position M12 lens
5	LED aimer
6	Mounting holes (M3 x 3.5 mm)



1	Remove side cover to access square nut (M3)
2	Yellow arrow indicates selected focus position
3	Hidden square nut as an alternative mounting option

DataMan 50 Accessories





CABLES

USB Cable, 1.5 m (DM100-USB-000), USB Cable, 3 m (DM100-USB-030)	
USB and Flying Leads I/O Cable, 2.0 m (DM-USBIO-00)	
RS-232 and Flying Leads I/O Cable, 2.5 m (DM-RS232IO-00)	
RS-232 Cable, 1.5 m (DM100-RS232-000), Extension Cable, 5 m (DM100-EXTCBL-000)	
Flying Leads Connection Cable, 5 m (DM50-PWRIO-05)	
RS-232/USB adapter connector (DM100-PATCH-000)	

LENS COVERS

Clear Front Cover (DM-50-CLCOV)	
ESD-safe Front Cover (DM50-CLCOV-ESD)	

OTHER

Power Supply, 6 V (DM100-PWR-000)	
Pivot Mounting Bracket (DM100-PIVOTM-00)	
Universal Mounting Bracket (DM50-UBRK-000)	
Control Box (DM-CTRLBOX-00)	

Dimensions

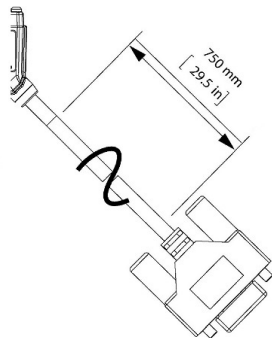
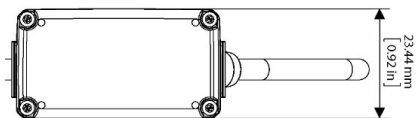
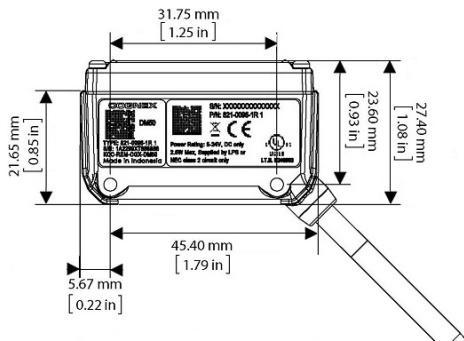

Field of View and Reading Distances

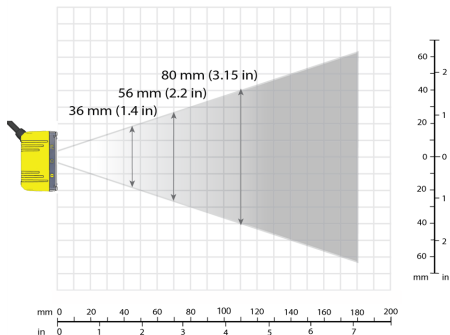

Focus position	Distances in mm/2D min. code		Distances in mm/1D min. code	
45 mm	33-51	6 MIL	34-51	4 MIL
	31-57	8 MIL	30-56	6 MIL
	27-60	10 MIL	37-66	10 MIL
	25-61	12 MIL		
70 mm	44-74	6 MIL	52-73	4 MIL
	42-78	8 MIL	45-83	6 MIL
	39-80	10 MIL	33-89	10 MIL
	34-89	12 MIL		
110 mm	58-121	10 MIL	66-122	6 MIL
	54-133	12 MIL	50-141	10 MIL
			58-168	15 MIL

Connecting the Reader

Perform the following steps:

1. Connect the breakout cable.
2. Connect the reader to the PC.

For information on the pinout and the wire colors, see section *Connections, Optics and Lighting* in the *DataMan 50 Reference Manual*.

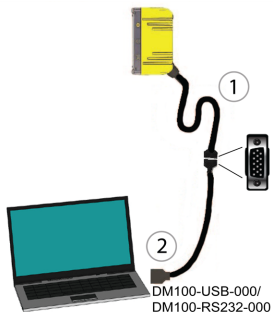

Installation

Installation procedures and specifications are presented in detail in the *DataMan® 50 Reference Manual*, which is installed with the DataMan Setup Tool. From the Windows Start menu, select the following to access the manual: *All Programs > Cognex > DataMan Software vx.x.x > Documentation*.

Note:



- Cables are sold separately.
- If a standard component is missing or damaged, immediately contact your Cognex Authorized Service Provider (ASP) or Cognex Technical Support.



CAUTION: All cable connectors are keyed to fit the connectors on the reader. Do not force the connections or damage may occur.

Mounting

Mounting the DataMan reader at a slight angle (15°) can reduce reflections and improve performance.

Use the set of mounting holes on the rear part to mount the DataMan reader.

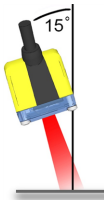

Connect the Breakout Cable

i **Note:** You can clip unused wires short or use a tie made of non-conductive material to tie them back. For RS-232, use the Power Supply return path for ground.

1. Verify that the power supply being used is unplugged and not receiving power.
2. Connect the cable on the back of the device to either a USB adapter cable with power tab or to an RS-232 adapter cable with power tab.
3. Connect a 6 V power supply.
4. Restore power to the power supply and turn it on if necessary.

Install Software and Documentation and Connect the Reader

Follow the steps below to connect your reader to power and network:

1. Connect the USB or RS-232 cable to your reader.
2. Connect the cable to a power supply.

To configure a DataMan 50 reader, the DataMan Setup Tool software must be installed on a networked PC. The DataMan Setup Tool is available from the DataMan support site: <http://www.cognex.com/support/dataman>.

1. After installing the software, connect the DataMan 50 reader to your PC.
2. Launch the DataMan Setup Tool and click **Refresh**.
3. Select your DataMan 50 reader from the list and click **Connect**.

DataMan 50 Specifications

Weight	76 g (including cable)		
Operating Temperature	0 °C — 40 °C (32 °F — 104 °F)		
Storage Temperature	-10 °C — 60 °C (-14 °F — 140 °F)		
Maximum Humidity	95% (non-condensing)		
Environmental	IP65 if sealing is installed properly		
Vibration	EN61373 including IEC 60068-2-6, 60068-2-64 6.4, and 60068-2-27		
LED Safety	IEC 62471: Exempt risk group, no further labeling is required.		
Codes	1-D barcodes: Codabar, Code 39, Code 128, and Code 93, Interleaved 2 of 5, Pharma, GS1 DataBar, Postal, UPC/EAN/JAN 2-D barcodes: Data Matrix™ QR Code and microQR Code, MaxiCode, RSS/CS, PDF 417, MicroPDF 417		
Discrete I/O Operating Limits	Output 0,1	I_{MAX} @ 24 VDC	25 mA
		V_{MAX}	26 V
	Output 2	Source V_{TYP}	4 V
		Sink V_{IH}	4 V - V_{PSU}
		V_{IL}	0 — 2 V
	Input 0 (Trigger)	V_{IH}	4 — 26 V
	Input 1	V_{IL}	0 — 2 V
		I_{TYP}	3 mA
Power Supply Requirements	V_{PSU} 4.5 — 26 VDC		
	2.5 W maximum LPS or NEC class 2 power supply		

DataMan 50 Imager Specifications

Specification	DataMan 50 Series Imager
Image Sensor	1/3 inch CMOS
Image Sensor Properties	4.51 mm x 2.88 mm (H x V), 6.0 μm square pixels
Image Resolution (pixels)	752 x 480
Electronic Shutter Speed	18 μs to 25 ms exposure
Image Acquisition	up to 60 fps at full resolution
Lens Type	6.2 mm, F:5,3 focal position M12 lens with IR blocking filter

LED Wavelengths

The following table shows LED types and the related wavelengths:



LED	λ [nm]
RED	617



Compliance Statements

DataMan 50 readers meet or exceed the requirements of all applicable standards organizations for safe operation. However, as with any electrical equipment, the best way to ensure safe operation is to operate them according to the agency guidelines that follow. Please read these guidelines carefully before using your device.

Regulator	Specification
USA	FCC Part 15, Subpart B, Class A
Canada	ICES-003, Class A
European Community	EN55022, Class A EN55024

i Note: For the most current CE declaration and regulatory conformity information, see the Cognex support site: cognex.com/support.

Safety and Regulatory	
European Compliance 	This is a class A product. In a domestic environment this product may cause radio interference in which case the user may be required to take immediate measures. This equipment complies with the essential requirements of the EU Directive 2014/30/EU. Declarations are available from your local representative. The CE mark on the product indicates that the system has been tested to and conforms with the provisions noted within the 2014/30/EU Electromagnetic Compatibility. For further information please contact: Cognex Corporation, One Vision Drive Natick, MA 01760 USA. Cognex Corporation shall not be liable for use of our product with equipment (i.e., power supplies, personal computers, etc.) that is not CE marked.
FCC Class A Compliance Statement 	This equipment has been tested and found to comply with the limits for a Class A digital device, pursuant to Part 15 of the FCC rules. These limits are designed to provide reasonable protection against harmful interference when the equipment is operated in commercial environment. This equipment generates, uses, and can radiate radio frequency energy and, if not installed and used in accordance with the instructions, may cause harmful interference to radio communications. Operation of this equipment in a residential area is likely to cause harmful interference, in which case the user will be required to correct the interference at personal expense.

Safety and Regulatory	
Canadian Compliance	This Class A digital apparatus complies with Canadian ICES-003. Cet appareil numérique de la classe A est conforme à la norme NMB-003 du Canada.
C-Tick Statement 	Conforms to AS/NZS CISPR 22/ EN 55022 for Class A Equipment.
UL and cUL Statement 	IEC 60950-1:2005 (2nd Edition); Am 1:2009
Korea	이 기기는 업무용 환경에서 사용할 목적으로 적합성평가를 받은 기기로서 가정용 환경에서 사용하는 경우 전파간섭의 우려가 있습니다. Regulatory Models R00075: R-REM-CGX-R00075. Regulatory Models R00076: R-REM-CGX-R00076.

LED Safety Statement

This device has been tested in accordance with IEC62471, and has been certified to be under the limits of Exempt Risk Group. No further labeling is required.

For European Community Users

Cognex complies with Directive 2012/19/EU OF THE EUROPEAN PARLIAMENT AND OF THE COUNCIL of 4 July 2012 on waste electrical and electronic equipment (WEEE).

This product has required the extraction and use of natural resources for its production. It may contain hazardous substances that could impact health and the environment, if not properly disposed.

In order to avoid the dissemination of those substances in our environment and to diminish the pressure on the natural resources, we encourage you to use the appropriate take-back systems for product disposal. Those systems will reuse or recycle most of the materials of the product you are disposing in a sound way.



The crossed out wheeled bin symbol informs you that the product should not be disposed of along with municipal waste and invites you to use the appropriate separate take-back systems for product disposal.

If you need more information on the collection, reuse, and recycling systems, please contact your local or regional waste administration.

You may also contact your supplier for more information on the environmental performance of this product.

China RoHS



Hazardous Substances 有害物质						
Part Name 部件名称	Lead (Pb) 铅	Mercury (Hg) 汞	Cadmium (Cd) 镉	Hexavalent Chromium (Cr (VI)) 六价铬	Polybrominated biphenyls (PBB) 多溴联苯	Polybrominated diphenyl ethers (PBDE) 多溴二苯醚
DM50	X	O	O	O	O	O
<p>This table is prepared in accordance with the provisions of SJ/T 11364. 这个标签是根据SJ/T 11364 的规定准备的。</p> <p>O: Indicates that said hazardous substance contained in all of the homogeneous materials for this part is below the limit requirement of GB / T26572 - 2011. 表示本部件所有均质材料中含有的有害物质低于GB / T26572 - 2011 的限量要求。</p> <p>X: Indicates that said hazardous substance contained in at least one of the homogeneous materials used for this part is above the limit requirement of GB / T26572 - 2011. 表示用于本部件的至少一种均质材料中所含的危害物质超过GB / T26572 - 2011 的限制要求。</p>						

Copyright © 2020
Cognex Corporation. All Rights Reserved.