

## DataMan<sup>®</sup> 360 Series Quick Reference Guide

2025 December 17  
Revision: 25.4.1.1

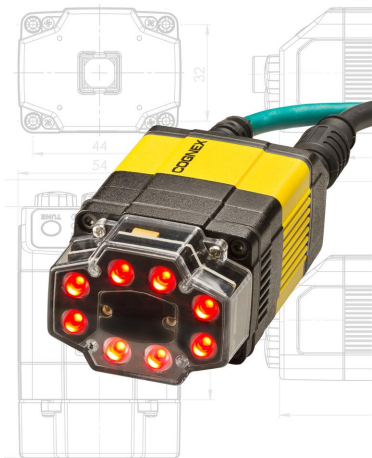

# Precautions

---



**WARNING: LASER LIGHT, DO NOT STARE INTO BEAM: CLASS 2 LASER PRODUCT. FAILURE TO FOLLOW THESE INSTRUCTIONS MAY CAUSE SERIOUS INJURY**

---

- This product is intended for industrial use in automated manufacturing or similar applications.
- The safety of any system incorporating this product is the responsibility of the assembler of the system.
- This product does not contain user-serviceable parts. Do not make electrical or mechanical modifications to product components. Unauthorized modifications can void your warranty.
- This device should be used in accordance with the instructions in this manual.
- CAUTION - Use of controls or adjustments or performance of procedures other than those specified herein may result in hazardous radiation exposure.
- Do not attempt to service or repair this product -- return it to Cognex for service.
- Do not permit anyone other than Cognex Corporation to service, repair, or adjust this product.
- Do not attempt to open or modify this device except as described in this document.
- Do not direct or reflect laser light toward people or reflective objects.
- Do not operate this device if it is damaged or if the covers or seals are missing or damaged.

- IP protection is ensured only when all connectors are attached to cables or shielded by a sealing cap.

This Laser Product is designated as Class 2 during all procedures of operation.

|                                |                   |
|--------------------------------|-------------------|
| Wavelength                     | 650 nm            |
| Laser Power for classification | < 1mW             |
| Beam Diameter                  | < 3mm at aperture |
| Divergence                     | < 1.5 mrad        |

# Symbols

The following symbols indicate safety precautions and supplemental information:



**WARNING:** This symbol indicates a hazard that could cause death, serious personal injury or electrical shock.

---



**CAUTION:** This symbol indicates a hazard that could result in property damage.

---



**Note:** This symbol indicates additional information about a subject.

---



**Tip:** This symbol indicates suggestions and shortcuts that might not otherwise be apparent.

---



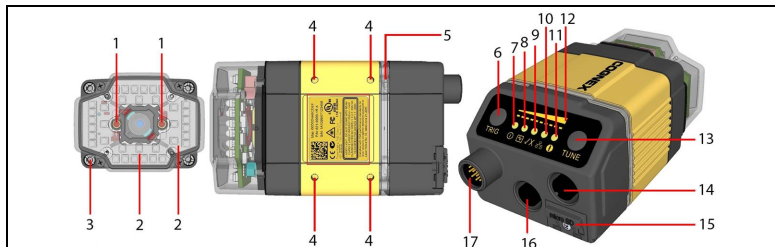

# Product Overview







| Number | Item                                 |
|--------|--------------------------------------|
| 1      | Laser aimer                          |
| 2      | Illumination LED clusters            |
| 3      | External illumination mounting point |
| 4      | Mounting holes (M3 x 5 mm)           |
| 5      | Indicator light ring                 |
| 6      | Trigger button                       |
| 7      | Power                                |
| 8      | Train status                         |
| 9      | Read/no-read indicator               |
| 10     | Network                              |
| 11     | Error                                |
| 12     | Peak meter                           |
| 13     | Tuning button                        |
| 14     | Ethernet                             |
| 15     | SD card slot                         |
| 16     | External light control               |
| 17     | Power, I/O, and RS232                |



# DataMan 360 Accessories

## LENS OPTIONS AND COVERS

|   |                                       |   |
|---|---------------------------------------|---|
| 10.3 mm M12 lens with locking<br>10.3 mm IR M12 lens with locking             | DM300-LENS-10<br>DM300-LENS-10-IR     |  |
| Liquid lens module and pre-focused 10.3 mm or 10.3 mm IR M12 lens with wrench | DM300-LENS-10LL<br>DM300-LENS-10LL-IR |  |
| 19 mm liquid lens module  | DM300-LENS-19LL                       |  |
| 16 mm M12 lens with locking without built-in IR blocking filter               | DM300-LENS-16                         |  |

|  |                 |   |
|--|-----------------|---|
| 8 mm F5.6 fixed aperture lens  | LEC-CFF08-F5.6  |   |
| 12 mm F8 fixed aperture lens   | LEC-CFF12-F8    |   |
| 16 mm F8 fixed aperture lens   | LEC-CFF16-F8    |   |
| 16 mm F11 fixed aperture lens  | LEC-CFF16-F11   |   |
| 25 mm F8 fixed aperture lens   | LEC-CFF25-F8    |   |
| 25 mm F11 fixed aperture lens  | LEC-CFF25-F11   |   |
| 35 mm F8 fixed aperture lens   | LEC-CFF35-F8    |   |
| 35 mm F11 fixed aperture lens  | LEC-CFF35-F11   |   |
| 35 mm F16 fixed aperture lens  | LEC-CFF35-F16   |   |
| 40 mm F11 fixed aperture lens  | LEC-CFF40-F11   |   |
| 40 mm F16 fixed aperture lens  | LEC-CFF40-F16   |   |
| 24 mm F6 liquid lens module with built-in IR blocking filter                 | DM360-LENS-24LL |  |
| 25 mm M12 lens with lens spacer and hex wrench (also requires Extension kit) | DM300-LENS-25   |  |
| Extension kit  | DM300-EXT       |  |

|   |  |   |
|---|--|---|
| DM500 C-Mount cover (use with HPIA)   | DM500-CMTLC-000  |   |
| DM500 Lens cover extender   | DM500-LNSEXT-000   |  |
| Clear lens cover  | DM300-CLCOV  |  |
| Clear lens cover with white LED illumination<br>(Risk Group Exempt acc. IEC 62471)  | DM300-CLCOV-WHI  |  |
| Diffuse lens cover with red LED illumination,<br>with blue LED illumination,<br>with IR LED illumination,<br>Polarizer lens cover with red LED illumination<br>(Risk Group Exempt acc. IEC 62471) | DM300-DLCOV-RE<br>DM300-DLCOV-BL<br>DM300-DLCOV-IR<br>DM300-PLCOV-RE |   |

|   |                 |   |
|---|-----------------|---|
| Red LED high-powered integrated light, 10.3 mm lens<br>(Risk Group Red LED Exempt acc. IEC 62471, Risk Group Green LED Aimer Exempt acc. IEC 62471)                     | DM360-HPIL-RE   |   |
| Polarized red LED high-powered integrated light, ESD safe, 10.3 mm lens<br>(Risk Group Red LED Exempt acc. IEC 62471, Risk Group Green LED Aimer Exempt acc. IEC 62471) | DM360-HPIL-RE-P |   |
| White LED high-powered integrated light, 10.3 mm lens<br>(Risk Group White LED low risk acc. IEC 62471, Risk Group Green LED Aimer Exempt acc. IEC 62471)               | DM360-HPIL-WHI  |   |
| Red LED high-powered integrated light, 24 mm lens<br>(Risk Group Red LED Exempt acc. IEC 62471)   | DMLT-HPIL-RE    |   |
| Polarized red LED high-powered integrated light, 24 mm lens<br>(Risk Group Green LED Aimer Exempt acc. IEC 62471)   | DMLT-HPIL-RE-P  |   |
| White LED high-powered integrated light, 24 mm lens<br>(Risk Group White LED low risk acc. IEC 62471, Risk Group Green LED Aimer Exempt acc. IEC 62471)                 | DMLT-HPIL-WHI   |   |
| C-Mount cover for C-Mount lenses  | DM300-CMCOV     |  |
| Short C-Mount cover for C-Mount lenses  | DM300-CMCOV-SH  |  |



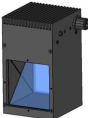





## EXTERNAL LIGHTS (RED LED) AND HIGH POWER ILLUMINATIONS

|                      |              |   |
|----------------------|--------------|---|
| Coaxial (DOAL) light | CLRO-K5050G1 |  |
|----------------------|--------------|---|

|                                 |                    |   |   |
|---------------------------------|--------------------|---|---|
| Spot light                      | CLRS-P14G1         |   |   |
| Bar light, blue                 | IVSL-LX520-470     |  |   |
| Bar light, red                  | IVSL-LX520-625     |   |   |
| HPIA, Red narrow                | DM30X-HPIA3-625    |  |   |
| HPIA, Red wide                  | DM30X-HPIA3-625-W  |   |   |
| HPIA, Red narrow with polarizer | DM30X-HPIA3-625P   |   |   |
| HPIA, Red wide with polarizer   | DM30X-HPIA3-625P-W |   |   |
| HPIA, White narrow              | DM30X-HPIA3-WHI    |   |   |
| HPIA, White wide                | DM30X-HPIA3-WHI-W  |   |   |
| HPIA, Blue narrow               | DM30X-HPIA3-470    |   |   |
| HPIA, Blue wide                 | DM30X-HPIA3-470-W  |   |   |
| HPIA, Infrared narrow           | DM30X-HPIA3-IR     |   |   |
| HPIA, Infrared wide             | DM30X-HPIA3-IR-W   |   |   |
| Red narrow                      | DM30X-HPIA-625     |   |  |
| Red wide                        | DM30X-HPIA-625-W   |   |   |
| Red narrow with polarizer       | DM30X-HPIA-625P    |   |   |
| White narrow                    | DM30X-HPIA-WHI     |   |   |
| White wide                      | DM30X-HPIA-WHI-W   |   |   |
| Blue narrow                     | DM30X-HPIA-470     |   |   |
| Blue wide                       | DM30X-HPIA-470-W   |   |   |
| Infrared narrow                 | DM30X-HPIA-IR      |   |   |
| Infrared wide                   | DM30X-HPIA-IR-W    |   |   |

## OTHER

|  |                                |   |
|--|--------------------------------|---|
| Connection cable 24V, I/O, RS-232 (y straight/angled, xx specifies length)   | CCB-M12x12Fly-xx               |  |
| Connection cable 24V, I/O, RS-232  | CCBL-05-01                     |   |
| Power and I/O breakout cable, M12-12, straight, xx specifies length: 5m, 10m, 15m, angled, xx specifies length: 5m, 10m, 15m | CCB-PWRIO- xx<br>CCB-PWRIO-xxR |   |

|   |   |   |
|---|---|---|
| Connection cable RS-232   | CCB-M12xDB9Y-05   |   |
| Power cable for multiple bar lights (use in combination with IVSL-5PM12-5)  | CCB-FOV25-MAL-012                                       |  |
| Ethernet M12 to RJ45 cable (y=1: straight / y=6: angled, x-xx specifies length)                                   | CCB-84901-y00x-xx                                       |  |
| External light cable (xxx specifies length)<br>Only compatible with CLRR / CLRB / CLRO / CLRS / CLRD illumination | CCB-M12x4MS-xxx   |  |
| Bar light cable (xxx specifies length: 300, 500, 1000, 2000 mm)<br>Compatible with IVSL lights, except IVSL-LX280 | IVSL-5PM12-Jxxx   |   |
| I/O extension cable, 5m straight  | CKR-200-CBL-EXT   |  |
| Laser aimer (use with HPIA)   | DM300-AIMER-00  |  |
| Connection module (4 or 1 camera)   | DMA-CCM-4X-xx <sup>1</sup> or DMA-CCM-1-xx <sup>2</sup> |  |
| Universal Mounting Bracket  | DM100-UBRK-000  |  |

<sup>1</sup> xx can be EU, UK, or JP.

<sup>2</sup> xx can be US, EU, UK, or JP.

Pivot Mounting Bracket

DM100-PIVOTM-01

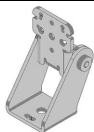

# Dimensions

|   |                            |
|---|----------------------------|
| A | S-Mount (M12) Lens version |
| B | C-Mount Lens version       |

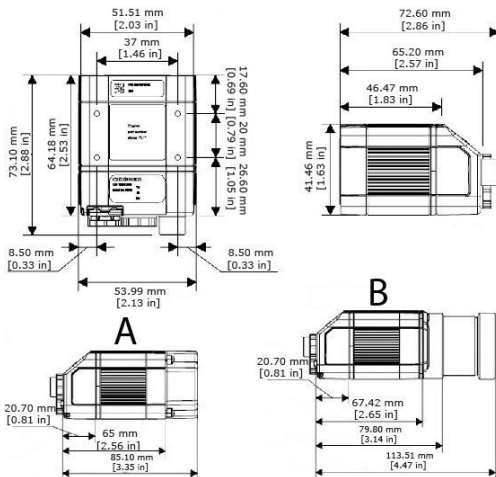

# Field of View and Reading Distances

**Note:** Due to tolerances, ranges can vary by +/- 5 % from unit to unit.

| 10.3 mm lens (green) | 16 mm lens (red)    | 25 mm lens (blue)   |
|----------------------|---------------------|---------------------|
| inner: DM360         | inner: DM360        | inner: DM360        |
| outer: DM362, DM363  | outer: DM362, DM363 | outer: DM362, DM363 |

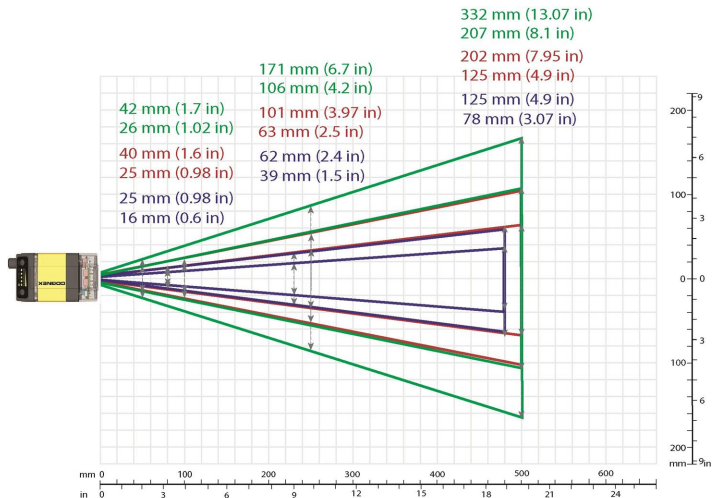

| Device          | Distances in mm/2D min. code 10.3 mm |        | Distances in mm/1D min. code 10.3 mm |        |
|-----------------|--------------------------------------|--------|--------------------------------------|--------|
|                 | lens                                 |        | lens                                 |        |
| DM360,<br>DM362 | 0-75                                 | 5 MIL  | 0-215                                | 7 MIL  |
|                 | 0-210                                | 10 MIL | 0-409                                | 13 MIL |
|                 | 0-374                                | 20 MIL | 0-500                                | 18 MIL |
| DM363           | 20-110                               | 5 MIL  | 20-350                               | 7 MIL  |
|                 | 15-325                               | 10 MIL | 25-735                               | 13 MIL |
|                 | 10-580                               | 20 MIL | 25-840                               | 18 MIL |

| Device          | Distances in mm/2D min. code 16 mm |        | Distances in mm/1D min. code 16 mm |        |
|-----------------|------------------------------------|--------|------------------------------------|--------|
|                 | lens                               |        | lens                               |        |
| DM360,<br>DM362 | 59-72                              | 2 MIL  | 60-125                             | 2 MIL  |
|                 | 55-207                             | 4 MIL  | 55-270                             | 4 MIL  |
|                 | 49-295                             | 8 MIL  | 56-400                             | 6 MIL  |
| DM363           | 35-190                             | 5 MIL  | 45-400                             | 7 MIL  |
|                 | 30-420                             | 10 MIL | 45-495                             | 13 MIL |
|                 | 25-500                             | 20 MIL | 45-540                             | 18 MIL |

| Device          | Distances in mm/2D min. code 25 mm |       | Distances in mm/1D min. code 25 mm |       |
|-----------------|------------------------------------|-------|------------------------------------|-------|
|                 | lens                               |       | lens                               |       |
| DM360,<br>DM362 | 100-155                            | 2 MIL | 95-155                             | 2 MIL |
|                 | 95-350                             | 4 MIL | 92-350                             | 4 MIL |
|                 | 90-470                             | 8 MIL | 88-380                             | 6 MIL |
| DM363           | 95-155                             | 2 MIL | 95-155                             | 2 MIL |
|                 | 90-350                             | 4 MIL | 92-360                             | 4 MIL |
|                 | 88-385                             | 8 MIL | 90-390                             | 6 MIL |

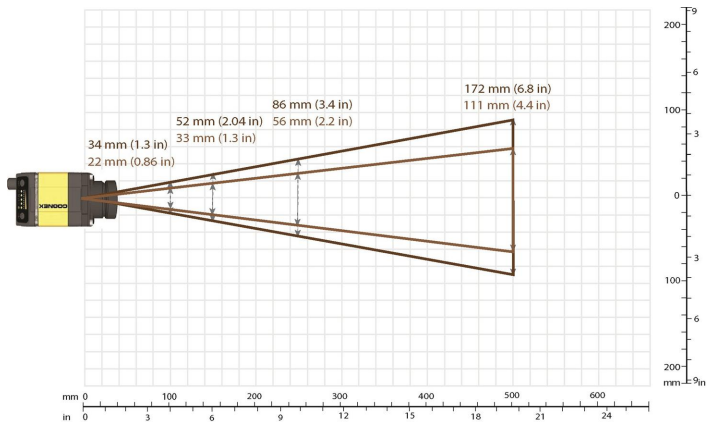

| Device  | Distances in mm/2D min. code |       | Distances in mm/1D min. code |       |
|---|------------------------------|-------|------------------------------|-------|
|   | 19 mm lens                   |       | 19 mm lens                   |       |
| DM360 (inner, brown), DM362<br>(outer, black) | 61-97                        | 2 MIL | 59-173                       | 2 MIL |
|   | 58-167                       | 4 MIL | 56-322                       | 4 MIL |
|   | 58-310                       | 8 MIL | 56-471                       | 6 MIL |
| DM363 (outer, black)                          | 61-109                       | 2 MIL | 29-199                       | 2 MIL |
|   | 58-192                       | 4 MIL | 56-375                       | 4 MIL |
|   | 58-361                       | 8 MIL | 56-551                       | 6 MIL |

24 mm lens, DM363: green

24 mm lens, DM362: brown

24 mm lens, DM360: red

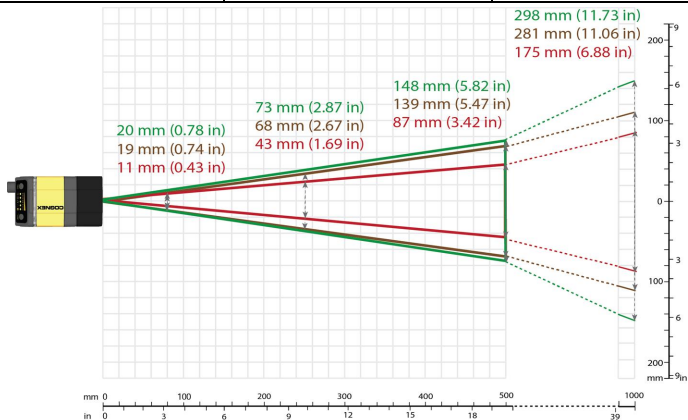

| Device | Distances in mm/2D min. code 24 mm lens |       | Distances in mm/1D min. code 24 mm lens |       |
|--------|---|-------|---|-------|
|        |   |       |   |       |
| DM360, | 80-120                                  | 2 MIL | 80-230                                  | 2 MIL |
| DM362  | 80-230                                  | 4 MIL | 80-460                                  | 4 MIL |
|        | 80-460                                  | 8 MIL | 80-690                                  | 6 MIL |

|       |        |       |        |       |
|-------|--------|-------|--------|-------|
| DM363 | 80-150 | 2 MIL | 80-270 | 2 MIL |
|       | 80-300 | 4 MIL | 80-540 | 4 MIL |
|       | 80-600 | 8 MIL | 80-810 | 6 MIL |

# Connecting the Reader

**CAUTION:** Make sure that the Ethernet cable is grounded at the far end. Whatever this cable is plugged into (usually a switch or router) should have a grounded Ethernet connector. Use a digital voltmeter to validate the grounding. If the far end device is not grounded, add a ground wire in compliance with local electrical codes.



**CAUTION:** To reduce emissions, connect the far end of the Breakout cable shield to frame ground.



Perform the following steps:

1. Mount the reader.
2. Connect the Ethernet cable to a computer or a switch.
3. Connect the breakout cable to a 24 V power supply.

For information on the cable pinout and wire colors, see section *Connections, Optics, and Lighting* in the *DataMan 360 Reference Manual*.



# Installation

Installation procedures are detailed in the *DataMan 360 Reference Manual*, which is installed with the DataMan Setup Tool. The DataMan Setup Tool is available from the DataMan support site: <http://www.cognex.com/support/dataman>.

To access documentation, open the Windows Start menu, select *All Programs > Cognex > DataMan Software vx.x.x > Documentation*.

---

**Note:**

- Cables are sold separately.
- If a standard component is missing or damaged, immediately contact your Cognex Authorized Service Provider (ASP) or Cognex Technical Support.



**CAUTION:** All cable connectors are "keyed" to fit the connectors on the DataMan system; do not force the connectors or damage may occur.

---

1. After installing the software, connect the DataMan 360 to your PC.
2. Launch the DataMan Setup Tool and click **Refresh**.
3. Select your DataMan 360 from the list and click **Connect**.

# Mounting

---



**CAUTION:** Make sure that the reader is grounded, either by mounting the reader to a fixture that is electrically grounded or by attaching a wire from the reader's mounting fixture to frame ground or Earth ground. If using a ground wire, attach it to one of the four mounting points on the back plate of the reader; not to the mounting points on the front of the reader.

---

Mounting the DataMan reader at a slight angle ( $15^{\circ}$ ) can reduce reflections and improve performance.

Use the set of mounting holes on the bottom part to mount the DataMan reader.



For more information on mounting, see the *DataMan 360 Reader Series Reference Manual*.

## Connect the Ethernet Cable

---



**CAUTION:** Make sure that the Ethernet cable is grounded at the far end. Whatever this cable is plugged into (usually a switch or router) should have a grounded Ethernet connector. Use a digital voltmeter to validate the grounding. If the far end device is not grounded, add a ground wire in compliance with local electrical codes.

---

1. Connect the Ethernet cable's M12 connector to the DataMan system's ENET connector.
2. Connect the Ethernet cable's RJ-45 connector to a switch/router or PC, as applicable.

## Connect the Breakout Cable

---



**CAUTION:** To reduce emissions, connect the far end of the Breakout cable shield to frame ground.

---

### Note:



- Make sure that the reader is not receiving power before you perform any I/O wiring or adjustments to I/O devices.
- You can clip unused wires short or use a tie made of non-conductive material to tie them back. Keep bare wires separated from the +24 VDC wire.

1. Verify that the 24 VDC power supply is unplugged and not receiving power.
2. Attach the Breakout cable's +24 VDC and Ground to the corresponding terminals on the power supply.



**CAUTION:** Never connect voltages other than 24 VDC. Always observe the polarity shown.

---

3. Attach the Breakout cable's M12 connector to the DataMan 360's 24 VDC connector.
4. Restore power to the 24 VDC power supply and turn it on if necessary.

# DataMan 360 Series Specifications

| Specification                 | DataMan 360 Reader  |           |  |
|-------------------------------|---|-----------|--|
| Weight                        | 165 g   |           |  |
| Operating Temperature         | 0°C — 40°C (+32°F — 104°F)<br>0°C — 50°C (+32°F — 122°F)  |           |  |
| Storage Temperature           | -10°C — +60°C (+14°F — +140°F)  |           |  |
| Maximum Humidity              | < 95% (non-condensing)  |           |  |
| Environmental                 | IP65 (with cable or protection cap attached to all connectors, front cover properly installed)  |           |  |
| LED Safety                    | IEC62471: red illumination: Exempt Risk Group, blue and white illuminations: Risk Group 1 (Low-Risk). No further labeling is required.  |           |  |
| RS-232                        | RxD, TxD according to TIA/EIA-232-F   |           |  |
| Codes                         | <b>1-D barcodes:</b> Codabar, Code 39, Code 128, and Code 93, Interleaved 2 of 5, MSI, Pharma, GS1 DataBar, Postal, UPC/EAN/JAN<br><b>2-D codes:</b> Data Matrix™ (IDMax and IDQuick: ECC 0, 50, 80, 100, 140, and 200), QR Code and microQR Code, MaxiCode, DotCode, Aztec Code, RSS/CS<br><b>Stacked codes:</b> PDF 417, MicroPDF 417 |           |  |
| Discrete I/O operating limits | HS Output 0,1,2,3   | $I_{MAX}$ | 50 mA                                    |
|                               |   | $R_{MIN}$ | @ 12 VDC<br>200 Ω                        |
|                               | Input 0 (Trigger)   | $V_{IH}$  | ±15 — ±28 V                              |
|                               | Input 1,2,3   | $V_{IL}$  | 0 — ±5 V                                 |
|                               |   | $I_{TYP}$ | @ 12 VDC<br>@ 24 VDC<br>2.0 mA<br>4.2 mA |

| Specification             | DataMan 360 Reader   |
|---------------------------|--|
| Power Supply Requirements | 24 V +/- 10%<br>Options: <ul style="list-style-type: none"> <li>• Internal illumination (non-HPIL*): 250 mA maximum, 5 W</li> <li>• Internal illumination (HPIL*): 2.2 A maximum, 6 W</li> <li>• External illumination: up to 1.2 A average, 45 W, peak current according to illumination, these values depend on the illumination and its configuration</li> </ul> Supplied by LPS or NEC class 2 only<br>*HPIL denotes one of the DM360-HPIL-RE or DM360-HPIL-RE-P accessories |
| Light Connector           | Current load up to 1.05 A average  |
| Ethernet Speed            | 10/100   |
| Duplex Mode               | Full duplex or half duplex   |

# DataMan 360 Series Imager Specifications

| Specification                        | DataMan 360 Series Imager   |
|--------------------------------------|---|
| Image Sensor                         | 1/1.8 inch CMOS   |
| Image Sensor Properties              | 6.9 mm x 5.5 mm (H x V); 5.3 $\mu$ m square pixels (DataMan 360 and 362), 4.5 $\mu$ m square pixels (DataMan 363)   |
| Image Resolution (pixels)            | <ul style="list-style-type: none"><li>• DataMan 360: 800 x 600</li><li>• DataMan 362: 1280 x 1024</li><li>• DataMan 363: 1600 x 1200</li></ul>  |
| Electronic Shutter Speed             | <ul style="list-style-type: none"><li>• minimum exposure: 5 <math>\mu</math>s (DataMan 360 and 362), 12 <math>\mu</math>s (DataMan 363)</li><li>• maximum exposure: 1000 <math>\mu</math>s with internal illumination/100000 <math>\mu</math>s with external illumination</li></ul>   |
| Image Acquisition at Full Resolution | <ul style="list-style-type: none"><li>• DataMan 360 and 362: up to 60 fps</li><li>• DataMan 363: up to 40 fps</li></ul>   |
| Lens Type                            | <ul style="list-style-type: none"><li>• S-Mount 10.3 mm F:5 (with optional liquid lens) with IR blocking filter</li><li>• S-Mount 16 mm F:9, no IR blocking filter</li><li>• C-Mount 24 mm F:6 (with liquid lens only) with IR blocking filter</li><li>• S-Mount 25 mm M12 lens, no IR blocking filter</li><li>• C-Mount lenses (with limitations, see below)</li></ul> |

## Limitations to C-Mount lenses:

- The length of the thread may not exceed 5.4 mm.
- For a chosen lens, the distance from the C-mount shoulder to the bottom of the lens may not exceed 5.4 mm. Possibly a lens spacer is required.

- When using the C-Mount lens cover, lens dimensions including spacer and filters may not exceed 32 x 42 mm (diameter x length).

To avoid accelerated aging of built-in illumination LEDs, which results in light intensity degradation, consider the following duty cycle limits above 25°C (77 °F):

- at 35 °C (95 °F): 4% duty cycle, for example, 750 µs exposure and 18493 µs interval
- at 45 °C (113 °F): 2% duty cycle, for example, 350 µs exposure and 18093 µs interval or 1000 µs exposure and 50000 µs interval

## LED Wavelengths

The following table shows LED types and the related peak wavelengths:

| LED            | $\lambda$ [nm]            |
|----------------|---------------------------|
| WHITE          | 6500K (Color Temperature) |
| BLUE           | 470                       |
| RED            | 617                       |
| HIGH POWER RED | 617                       |
| IR             | 850                       |

# Regulations and Conformity

**i Note:** For the most current CE and UKCA declaration and regulatory conformity information, see the Cognex support site: [cognex.com/support](http://cognex.com/support).

DataMan 360 and 362 readers have Regulatory Model 1AA4, DataMan 363 readers have Regulatory Model 1ABG and meet or exceed the requirements of all applicable standards organizations for safe operation. However, as with any electrical equipment, the best way to ensure safe operation is to operate them according to the agency guidelines that follow. Please read these guidelines carefully before using your device.

| Regulator   | Specification  |
|---|--|
| Manufacturer  | Cognex Corporation<br>One Vision Drive<br>Natick, MA 01760 USA                     |
| USA   | FCC Part 15, Class A<br>FDA/CDRH Laser Notice No 50 and 56                         |
| Canada  | ICES-003, Class A  |
| European<br>Community   | EN55022, Class A<br>EN55024<br>EN60950<br>EN60825-1                                |
| Australia<br> | Radiocommunications (Electromagnetic Compatibility) Standard: 2017 (EN 55032:2012) |
| Korea   | MSIP-REM-CGX-DM360   |

## Safety and Regulatory

European Compliance



**WARNING:** This is a class A product. In a domestic environment this product may cause radio interference in which case the user may be required to take adequate measures.

The CE mark on the product indicates that the system has been tested to and conforms to the provisions noted within the 2014/30/EU Electromagnetic Compatibility Directive. For further information please contact: Cognex Corporation, One Vision Drive, Natick, MA 01760, USA . Cognex Corporation shall not be liable for use of our product with equipment (i.e., power supplies, personal computers, etc.) that is not CE.

FCC Class A Compliance Statement



This equipment has been tested and found to comply with the limits for a Class A digital device, pursuant to Part 15 of the FCC rules. These limits are designed to provide reasonable protection against harmful interference when the equipment is operated in commercial environment. This equipment generates, uses, and can radiate radio frequency energy and, if not installed and used in accordance with the instructions, may cause harmful interference to radio communications. Operation of this equipment in a residential area is likely to cause harmful interference, in which case the user will be required to correct the interference at personal expense.

Canadian Compliance

This Class A digital apparatus complies with Canadian ICES-003. Cet appareil numérique de la classe A est conforme à la norme NMB-003 du Canada.

| Safety and Regulatory |  |
|-----------------------|--|
| TÜV                   | DataMan 360 and 362: Regulatory Model 1AA4<br>DataMan 363: Regulatory Model 1ABG |
|                       | TÜV SÜD SCC/NRTL OSHA Scheme for UL/CAN 61010-1.                                 |
|                       | TÜV SÜD, IEC/EN 61010-1. CB report available upon request.                       |

## Laser Safety Statement



Compliance with FDA performance standards for laser products except for deviations pursuant to Laser Notice No. 50, dated June 24, 2007.

This device has been tested in accordance with IEC60825-1 3rd ed., 2014., and has been certified to be under the limits of a Class 2 Laser device.



Use of controls or adjustments or performance of procedures other than those specified herein may result in hazardous radiation exposure.

## LED Safety Statement

This device has been tested in accordance with IEC62471, and red illumination has been certified to be under the limits of Exempt Risk Group, blue and white illuminations have been certified to be under the limits of Risk Group 1 (Low-Risk). No further labeling is required.

## For European Community Users

Cognex complies with Directive 2012/19/EU OF THE EUROPEAN PARLIAMENT AND OF THE COUNCIL of 4 July 2012 on waste electrical and electronic equipment (WEEE).

This product has required the extraction and use of natural resources for its production. It may contain hazardous substances that could impact health and the environment, if not properly disposed.

In order to avoid the dissemination of those substances in our environment and to diminish the pressure on the natural resources, we encourage you to use the appropriate take-back systems for product disposal. Those systems will reuse or recycle most of the materials of the product you are disposing in a sound way.



The crossed out wheeled bin symbol informs you that the product should not be disposed of along with municipal waste and invites you to use the appropriate separate take-back systems for product disposal.

If you need more information on the collection, reuse, and recycling systems, please contact your local or regional waste administration.

You may also contact your supplier for more information on the environmental performance of this product.

# 中国大陆RoHS (Information for China RoHS Compliance)

根据中国大陆《电子信息产品污染控制管理办法》(也称为中国大陆RoHS), 以下部份列出了本产品中可能包含的有毒有害物质或元素的名称和含量。



Table of toxic and hazardous substances/elements and their content, as required by China's management methods for controlling pollution by electronic information products.

|  | Hazardous Substances 有害物质 |                      |                      |  |   |  |
|--|---------------------------|----------------------|----------------------|--|---|--|
| Part Name<br>部件名称  | Lead (Pb)<br>铅            | Mercury<br>(Hg)<br>汞 | Cadmium<br>(Cd)<br>镉 | Hexavalent<br>Chromium<br>(Cr (VI))<br>六价铬 | Polybrominated<br>biphenyls (PBB)<br>多溴联苯 | Polybrominated<br>diphenyl ethers<br>(PBDE)<br>多溴二苯醚 |
| Regulatory Model 1AA4<br>Regulatory Model 1ABG   | X                         | O                    | O                    | O  | O   | O  |
| <p>This table is prepared in accordance with the provisions of SJ/T 11364.<br/>这个标签是根据SJ/T 11364的规定准备的。</p> <p>O: Indicates that said hazardous substance contained in all of the homogeneous materials for this part is below the limit requirement of GB / T26572 - 2011.<br/>表示本部件所有均质材料中含有的有害物质低于GB / T26572 - 2011 的限量要求。</p> <p>X: Indicates that said hazardous substance contained in at least one of the homogeneous materials used for this part is above the limit requirement of GB / T26572 - 2011.<br/>表示用于本部件的至少一种均质材料中所含的有害物质超过GB / T26572 - 2011 的限制要求。</p> |                           |                      |                      |  |   |  |

Copyright © 2025  
Cognex Corporation. All Rights Reserved.