

DataMan[®] 290 Series Reference Manual



2025 December 17
Revision: 25.4.1.1

Legal Notices

The software described in this document is furnished under license, and may be used or copied only in accordance with the terms of such license and with the inclusion of the copyright notice shown on this page. Neither the software, this document, nor any copies thereof may be provided to, or otherwise made available to, anyone other than the licensee. Title to, and ownership of, this software remains with Cognex Corporation or its licensor. Cognex Corporation assumes no responsibility for the use or reliability of its software on equipment that is not supplied by Cognex Corporation. Cognex Corporation makes no warranties, either express or implied, regarding the described software, its merchantability, non-infringement or its fitness for any particular purpose.

The information in this document is subject to change without notice and should not be construed as a commitment by Cognex Corporation. Cognex Corporation is not responsible for any errors that may be present in either this document or the associated software.

Companies, names, and data used in examples herein are fictitious unless otherwise noted. No part of this document may be reproduced or transmitted in any form or by any means, electronic or mechanical, for any purpose, nor transferred to any other media or language without the written permission of Cognex Corporation.

Copyright © 2025. Cognex Corporation. All Rights Reserved.

Portions of the hardware and software provided by Cognex may be covered by one or more U.S. and foreign patents, as well as pending U.S. and foreign patents listed on the Cognex web site at: cognex.com/patents.

The following are registered trademarks of Cognex Corporation:

2DMax, Advantage, AlignPlus, AssemblyPlus, Checker, Cognex, Cognex Vision For Industry, CVL, DataMan, DVT, EasyBuilder, Edge Intelligence, Hotbars, In-Sight, MX, OmniView, PatFind, PatFlex, PatInspect, PatMax, PatMax RedLine, PatQuick, PowerGrid, Smart View, SmartAdvisor, UltraLight, VisionPro, VisionView

The following are trademarks of Cognex Corporation:

The Cognex logo, 1DMax, 3D-Locate, 3DMax, BGAI, CheckPoint, Cognex VSoC, CVC-1000, FFD, iLearn, In-Sight (design insignia with cross-hairs), In-Sight 2000, InspectEdge, Inspection Designer, MVS, NotchMax, OCRMax, PatMax RedLine, ProofRead, SmartSync, ProfilePlus, SmartDisplay, SmartSystem, SMD4, VisiFlex, Xpand

Portions copyright © Microsoft Corporation. All rights reserved.

Portions copyright © MadCap Software, Inc. All rights reserved.

Other product and company trademarks identified herein are the trademarks of their respective owners.

Precautions

To reduce the risk of injury or equipment damage, observe the following precautions when you install the Cognex product:

- The reader requires a UL or NTRL listed power supply with a 24 V DC output that meets the following rating requirements:
 - 24 V DC (+/- 10%) output connection using a UL or NTRL listed LPS or NEC Class 2 power supply power supply

Any other voltage creates a risk of fire or shock and can damage the components. Applicable national and local wiring standards and rules must be followed.

- This product is intended for industrial use in automated manufacturing or similar applications.
- The safety of any system incorporating this product is the responsibility of the assembler of the system.
- Do not install Cognex products where they are exposed to environmental hazards such as excessive heat, dust, moisture, humidity, impact, vibration, corrosive substances, flammable substances, or static electricity.
- Route cables and wires away from high-current wiring or high-voltage power sources to reduce the risk of damage or malfunction from the following causes: over-voltage, line noise, electrostatic discharge (ESD), power surges, or other irregularities in the power supply.
- Do not expose the image sensor to laser light. Image sensors can be damaged by direct, or reflected, laser light. If your application requires laser light that might strike the image sensor, use a lens filter at the corresponding laser wavelength. For suggestions, contact your local integrator or application engineer.
- This product does not contain user-serviceable parts. Do not make electrical or mechanical modifications to product components. Unauthorized modifications can void your warranty.
- Changes or modifications not expressly approved by the party responsible for regulatory compliance could void the user's authority to operate the equipment.
- All cables connected to device need to be certified for CYJV or PVVA.
- Include service loops with cable connections.
- Ensure that cable strain relief is applied within strain relief zone. The strain relief zone is between two inches to six inches from the connector.
- Ensure that the cable bend radius begins at least six inches from the connector. Cable shielding can be degraded or cables can be damaged or wear out faster if a service loop or bend radius is tighter than 10X the cable diameter.
- This device should be used in accordance with the instructions in this manual.
- All specifications are for reference purposes only and can change without notice.

Symbols

The following symbols indicate safety precautions and supplemental information:

 **WARNING:** This symbol indicates a hazard that could cause death, serious personal injury or electrical shock.

 **CAUTION:** This symbol indicates a hazard that could result in property damage.

 **Note:** This symbol indicates additional information about a subject.

 **Tip:** This symbol indicates suggestions and shortcuts that might not otherwise be apparent.

Table of Contents

Legal Notices	2
Precautions	3
Symbols	4
Table of Contents	5
Getting Started	7
About the DataMan 290 Series	7
Supporting Documentation	8
DataMan 290 Series Systems	9
Accessories	10
Lenses	10
Lens Covers	10
Illumination	11
Mounting Brackets	11
Cables	12
Setting Up Your DataMan 290 Reader	13
DataMan 290 Layout	13
Dimensions	14
DataMan 290 with Multi-Purpose Integrated Light and 6.2 mm Lens	14
DataMan 290 with Multi-Purpose Integrated Light and 16 mm Lens	15
DataMan 290 with Mini Light and 6.2 mm Lens	16
DataMan 290 with Mini Light and 16 mm Lens	17
Field of View and Working Distance	18
DataMan 290 Reader with 6.2 mm Lens	18
DataMan 290 Reader with 16 mm Lens	19
Mounting the Reader	22
Connection Options	23
Connecting the Ethernet Cable	23
Connecting the Power and I/O Breakout Cable	23
Power and I/O Breakout Cable (CCB-M12x12Fy-xx)	23
Using your DataMan 290 Reader Through USB	24
Using Your DataMan 290 Reader	27
Connect to DataMan WebUI	27
Installing the DataMan Setup Tool	28
Trigger Types	28
External Triggers	29
Industrial Protocols	29
Specifications	31
DataMan 290 Series Reader	31
DataMan 290 Series Reader Image Sensor	32
LED Wavelengths	32
Acquisition Trigger Input	33
High-Speed Outputs	33
High Speed Output Wiring	34

Ethernet Cable	36
Power and I/O Breakout Cable (CCB-M12x12Fy-xx)	37
Power and I/O Breakout Cable (CCBL-05-01)	38
Power and I/O Breakout Cable (CCB-PWRIO-xx)	39
Cleaning and Maintenance	40
Clean the Housing	40
Clean the Reader Image Sensor Window	40
Clean the Reader Lens Cover	40
Regulations and Conformity	41
中国大陆RoHS (Information for China RoHS Compliance)	42
For European Community Users	42

Getting Started

This section provides general information about the DataMan 290 series reader and the accessories and systems.

About the DataMan 290 Series

The DataMan 290 series readers are high-performance readers that offer:

- Embedded AI, industry-proven decoding algorithms, and powerful lighting working together to deliver high read rates.
- Guided setup, AI tuning, and real-time feedback, ensuring successful scanning from the start.
- End-to-end support, from training and deployment to ongoing management and optimization.







Supporting Documentation

This document provides basic information about the DataMan 290 series readers. Additional information is available through the Windows **Start** menu or the DataMan Setup Tool **Help** menu after you install the DataMan software on your PC.

Note: For the latest documentation, visit: support.cognex.com/documentation/dataman.

- The **DataMan Communications and Programming Guide** shows you how to integrate your DataMan reader into your particular automation and factory environment.
Cognex > DataMan Software v x.x.x > Documentation > Communications > DataMan Communications and Programming Guide
- The **DataMan Industrial Protocols Manual** provides information on how to integrate DataMan readers into your particular environment using industrial protocols.
Cognex > DataMan Software v x.x.x > Documentation > Communications > DataMan Industrial Protocols Manual
- The **DataMan Reader Configuration Codes** document provides printable 2-D codes that you can use to configure the DataMan reader.
Cognex > DataMan Software v x.x.x > Documentation > English > Reader Configuration Codes
- The **DM290 Quick Reference Guide** provides essential information about the DM290 reader.
Cognex > DataMan Software v x.x.x > Documentation > English > DM290 Series > DM290 Quick Reference Guide
- The **DataMan Fixed-Mount Readers Reference** is a complete online hardware reference for the DataMan fixed-mount ID readers.
Cognex > DataMan Software v x.x.x > Documentation > English > DM290 > Fixed-Mount Reference Manual
- The **DataMan Questions and Answers** document provides context-sensitive information. You can view this help inside the DataMan Setup Tool or as a stand-alone help file.
Cognex > DataMan Software v x.x.x > Documentation > DM290 > Questions and Answers
- The **DataMan Control Commands** lists DataMan Control Commands with all relevant information. You can view this help inside the Setup Tool or as a stand-alone help file.
Cognex > DataMan Software v x.x.x > Documentation > English > DataMan Control Commands
- The **Setup Tool Reference Manual** describes the user interface of the DataMan Setup Tool software.
Cognex > DataMan Software v x.x.x > Documentation > English > Setup Tool Reference Manual
- The **Release Notes** list detailed system requirements and additional information about the DataMan software release.
Cognex > DataMan Software v x.x.x > Documentation > DataMan v x.x.x Release Notes

DataMan 290 Series Systems

Illustration	Product ID		Illumination	Lens	Front Cover
	Reader-only	Accessory Bundle			
	DM290X-16-LM	DM290X-16-LM-05	Multi-Purpose Integrated Light	16 mm high-speed liquid lens	Clear, polarized, diffuse
	DM290X-06-LM	DM290X-06-LM-05	Multi-Purpose Integrated Light	6.2 mm high-speed liquid lens	Clear, polarized, diffuse
	DM290X-16-SP	DM290X-16-SP-05	Mini Light	16 mm high-speed liquid lens	Half-polarized
	DM290X-06-SC	DM290X-06-SC-05	Mini Light	6.2 mm high-speed liquid lens	Clear



The accessory bundles include the following items:

- Power and I/O breakout cable (CCB-PWRIO-05)
- Ethernet cable (CCB-84901-2001-05)
- Mounting bracket (DM290-UBRK-000)



Accessories

You can purchase the following components separately. For a list of options and accessories, contact your local Cognex sales representative.

Lenses

Accessory	Illustration
6.2 mm lens	
16 mm lens	

Lens Covers

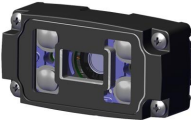

Accessory	Product Number	Illustration
Extended front cover. Use with a 16 mm lens only.	DM260-LENS-16CVR	
Extended front cover, half-polarized. Use with a 16 mm lens only.	DM260-LENS-16CVR-P	
Extended front cover, fully-polarized. Use with a 16 mm lens only.	DM260-LENS-16CVR-F	
Clear Cover for Standard Light	280-STD-COVCLR	
Diffused Cover for Standard Light	280-STD-COVDIF	
Polarized Cover for Standard Light	280-STD-COVPOL	
Multi front cover that includes clear, polarized, diffused.	DM290-MULTI-COV	

Illumination

Accessory	Illustration	Color	Maximum Exposure time	Maximum Duty Cycle	
				2 Active LEDs	4 Active LEDs
Multi-Purpose Integrated Light		Red (clear and half-polarized light)	10 ms	10%	6%
		White (diffused light)			
Mini Light		Red (6.2 mm model)			
		Red (16 mm model)			













Mounting Brackets

Note: The backside of the reader needs to be connected to a metal part that can serve as a heatsink.

Accessory	Product Number	Illustration
Universal mounting bracket	DM290-UBRK-000	
Pivot mounting bracket	DM100-PIVOTM-01	

Cables

Note: Cables are sold separately or as part of an accessory bundle. For more information, contact your Cognex sales representative.

Accessory	Product Number	Illustration
Ethernet Cable, X-coded M12-8 to RJ-45	CCB-84901-2001-xx (straight, xx specifies length: 2m, 5m, 10m, 15m, 30m)	
Ethernet Cable, X-coded M12-8 to RJ-45	CCB-84901-2002-xx (right-angled, xx specifies length: 2m, 5m, 10m)	
Ethernet Cable, Robotic X-Coded M12-8 to RJ-45	CCB-84901-2RBT-xx (straight, xx specifies length: 2m, 5m, 10m)	
X-Coded to A-Coded Ethernet cable adapter, 0.5 m	CCB-M12X8MS-XCAC	
Power and I/O Breakout Cable, M12-12 to Flying Lead	CCB-M12x12Fy-05 (y = straight/angled, xx specifies length)	
Power and I/O Breakout Cable, M12-12 to Flying Lead	CCBL-05-01	
Power and I/O Breakout Cable, M12-12 to Flying Lead	CCB-PWRIO- xx (straight, xx specifies length: 5m, 10m, 15m)	
Power and I/O Breakout Cable, M12-12 to Flying Lead	CCB-PWRIO-xxR (right-angled, xx specifies length: 5m, 10m, 15m)	
Power and I/O Breakout Cable, M12-12 to DB15	CCB-PWRIO-MOD-xx (xx specifies length: 2m, 5m)	
RS-232 Connection Cable	CCB-M12xDB9Y-05	
I/O Extension Cable	CKR-200-CBL-EXT	
Sealed USB Type C Cable to USB Type A, Straight, 2.5 m	DMA-STCBLE-IP65-25	
Sealed USB Type C Cable to USB Type A, Straight 3.6 m	DMA-STCBLE-IP65-36	
Sealed USB Type C Cable to USB Type A, Angled, 2.5 m	DMA-RTCBLE-IP65-25	
Sealed USB Type C Cable to USB Type A, Angled, 3.6 m	DMA-RTCBLE-IP65-36	

Setting Up Your DataMan 290 Reader

Read this section to learn how the reader connects to its standard components and accessories.

CAUTION: All cable connectors are keyed to fit the connectors on the reader. Do not force the connections or damage may occur.

DataMan 290 Layout

The image and table below shows the elements of the reader.

Number	Description
1	Power I/O Breakout cable connector
2	USB-C slot (with plastic cover)
3	Ethernet connector
4	Trigger button
5	Tune button
6	Power LED indicator
7	Train status/Trigger status LED indicator
8	Good/bad read LED indicator
9	Communication LED indicator
10	Error LED indicator

Dimensions

The following sections list dimensions of the reader.

Note:

- Dimensions are in millimeters and are for reference purposes only.
- All specifications are for reference purposes only and can change without notice.

DataMan 290 with Multi-Purpose Integrated Light and 6.2 mm Lens

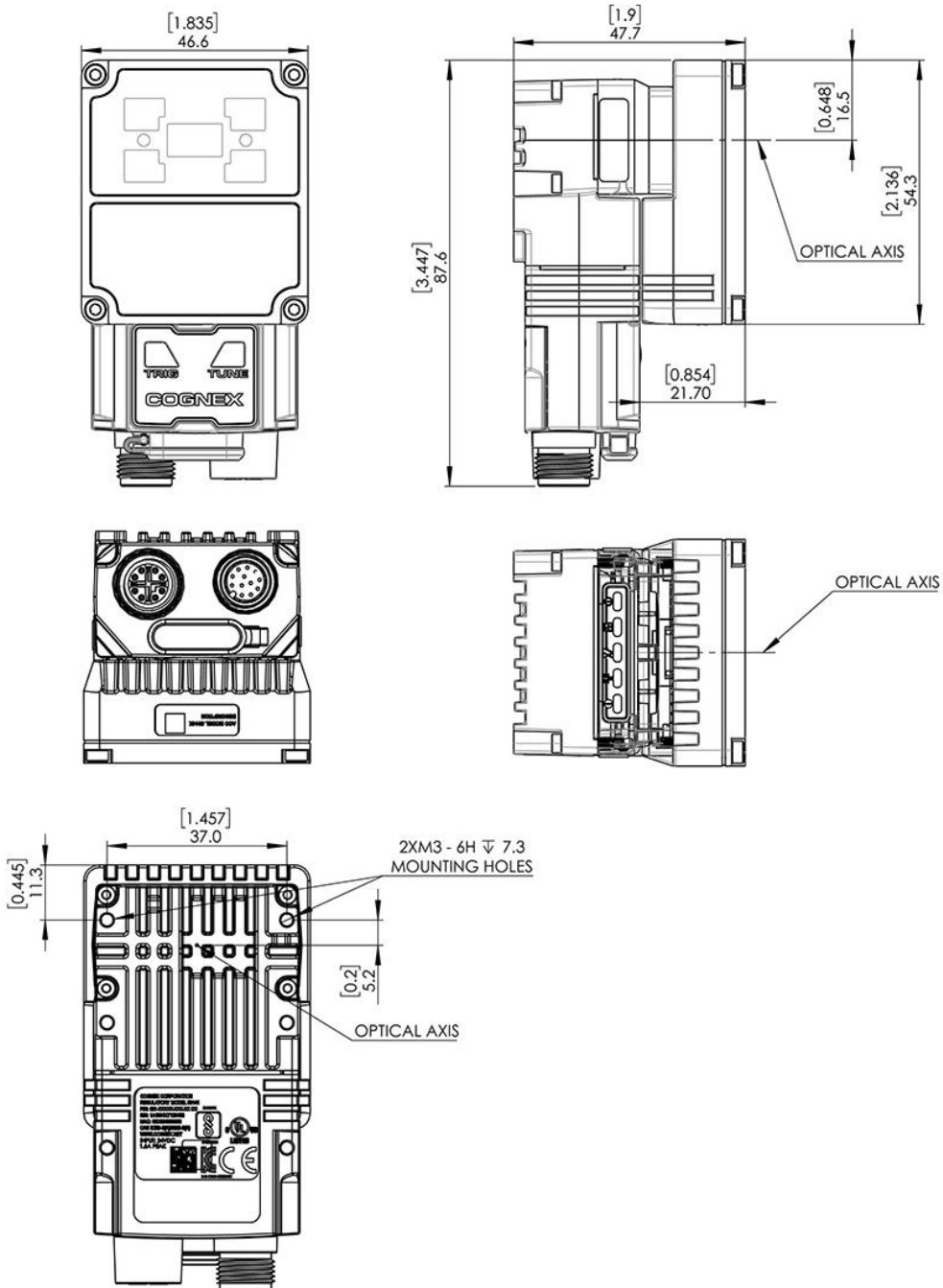

DataMan 290 with Multi-Purpose Integrated Light and 16 mm Lens

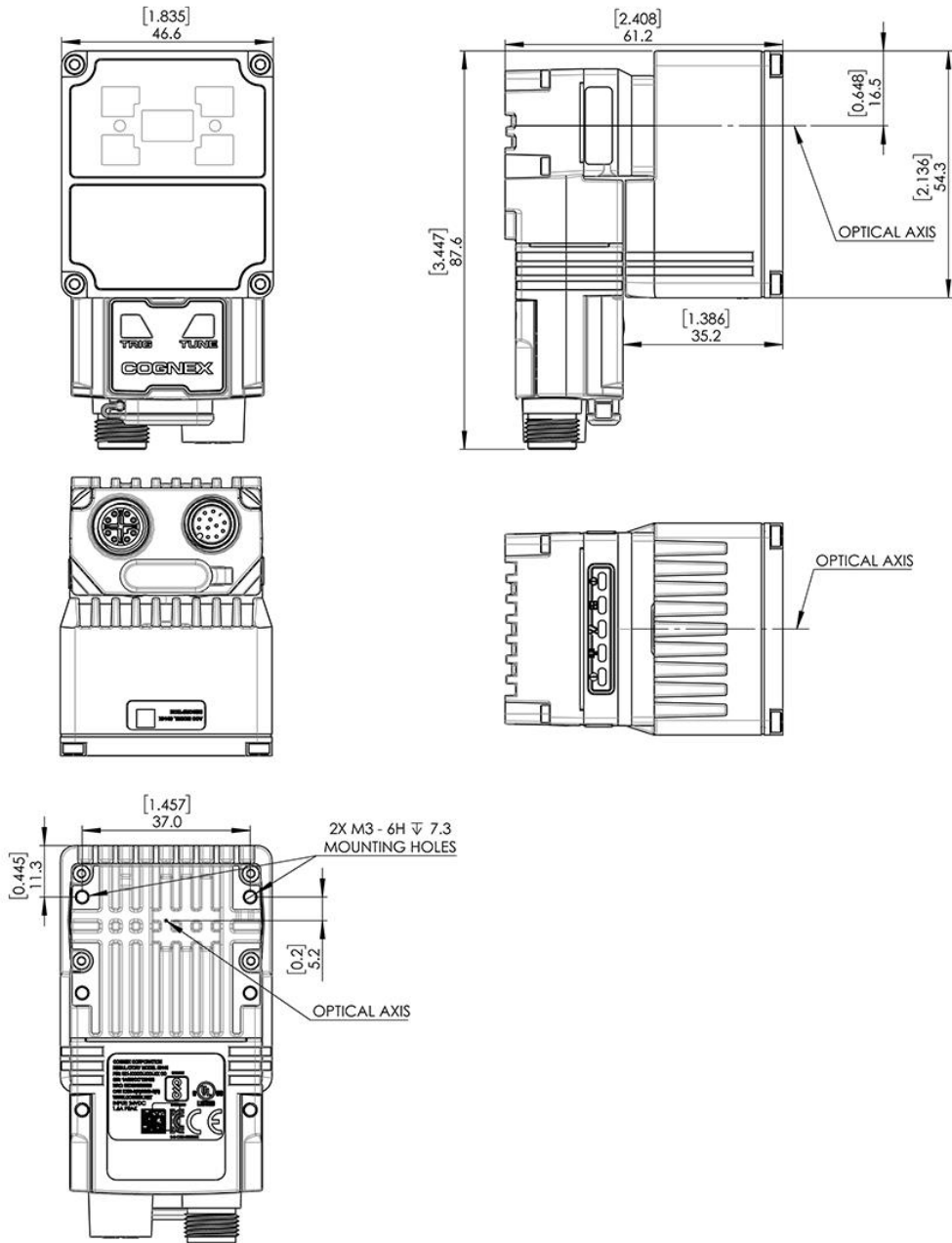

DataMan 290 with Mini Light and 6.2 mm Lens

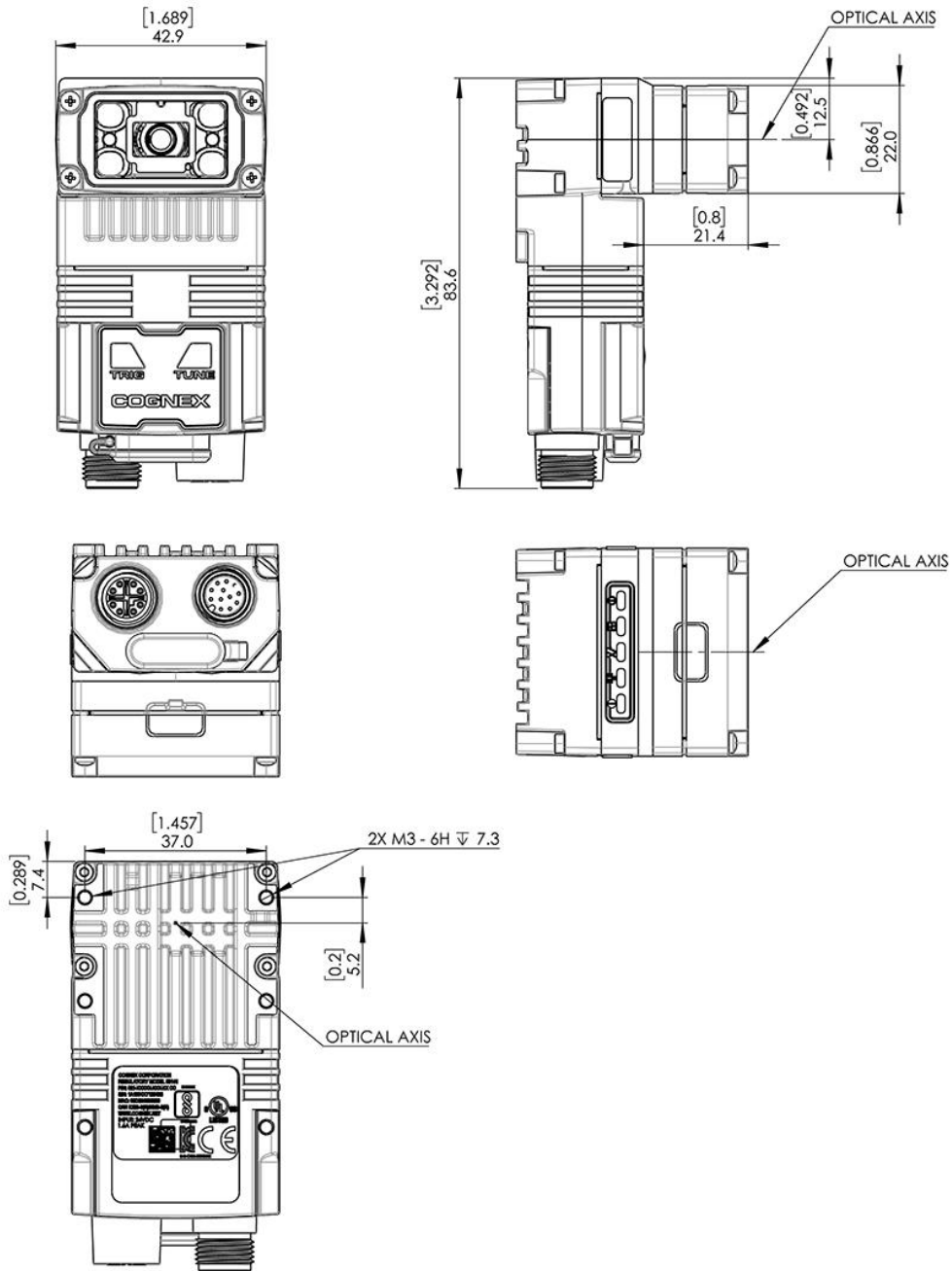

DataMan 290 with Mini Light and 16 mm Lens

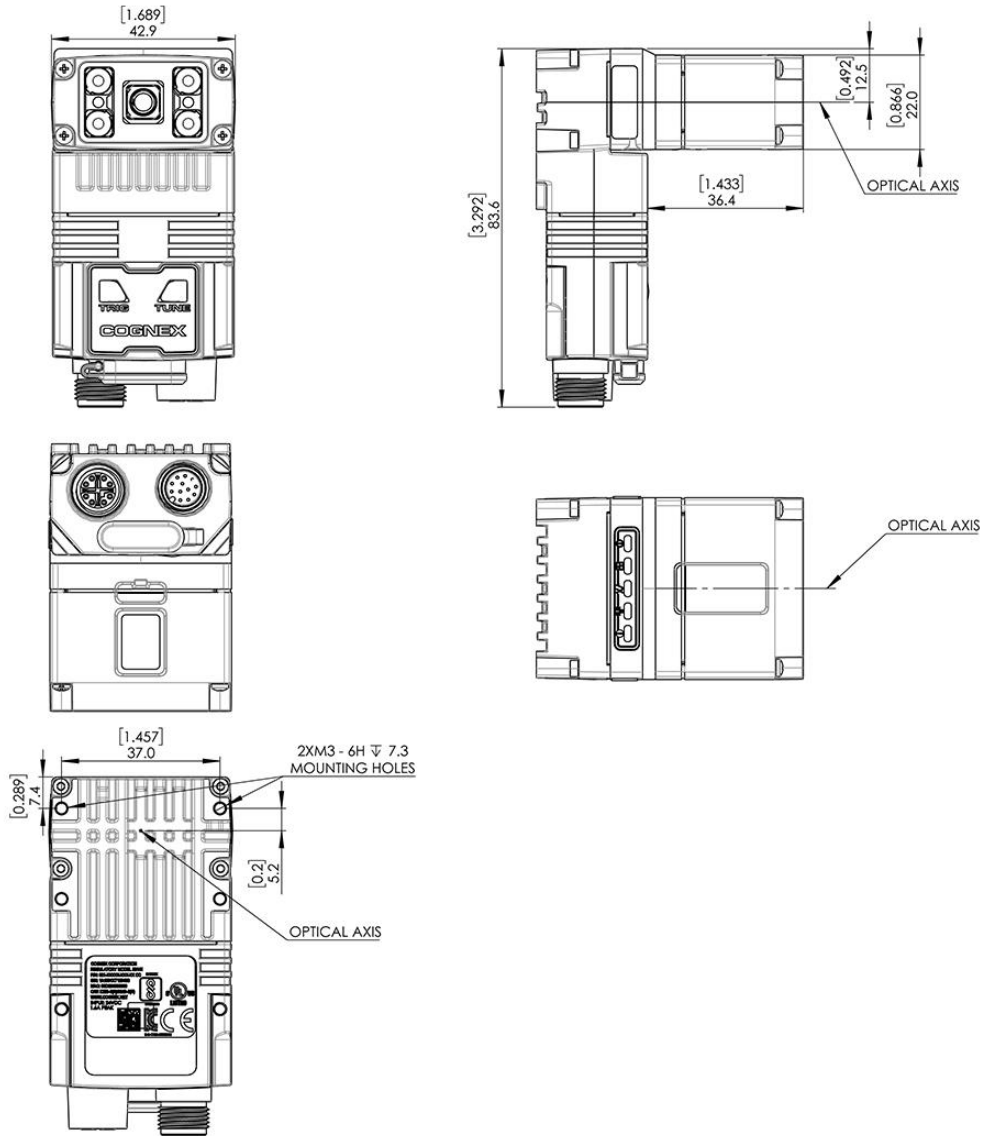

Field of View and Working Distance

This section provides the Field of View (FoV) values for 6.2 mm and 16 mm lenses.

DataMan 290 Reader with 6.2 mm Lens

The following tables show the Field of View (FoV) widths of the 6.2 mm lens at various distances.

Note:

The 6.2 mm lens has two default focus distances that provide the same FoV at different working distance ranges:



- Short-range focus at 105 mm for 65–200 mm working distance.
- Far-range focus at 190 mm for 80–500 mm working distance.

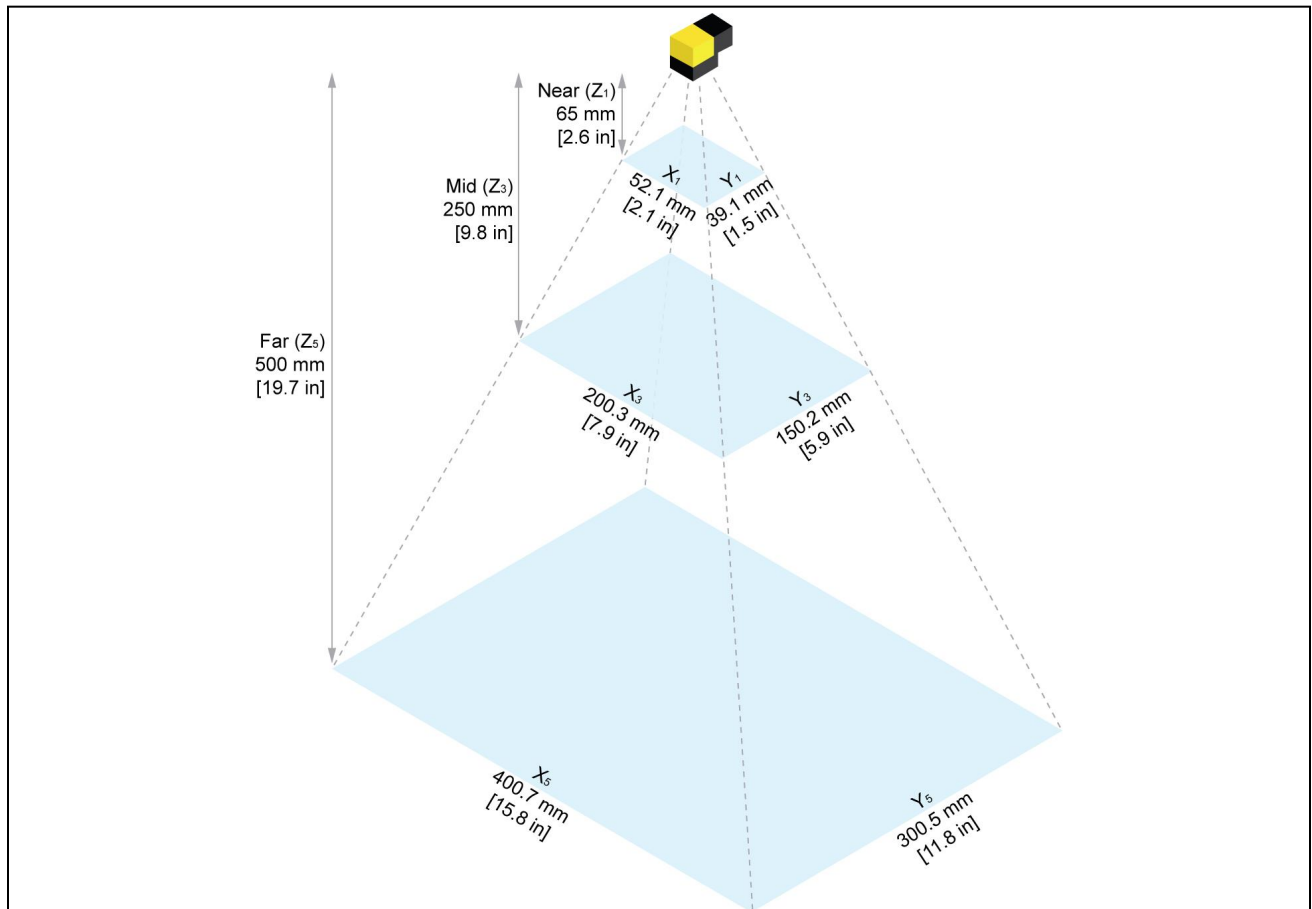

Working Distance	Horizontal Values	Vertical Values
65 mm [2.6 in]	52.1 mm [2.1 in]	39.1 mm [1.5 in]
250 mm [9.8 in]	200.3 mm [7.9 in]	150.2 mm [5.9 in]
500 mm [19.7 in]	400.7 mm [15.8 in]	300.5 mm [11.8 in]

1D Field of View table with 6.2 mm Lens:

1D min. code in mil	Distances in mm
4 mil	157 mm
6 mil	233 mm
10 mil	385 mm
14 mil	537 mm
20 mil	765 mm

2D Field of View table with 6.2 mm Lens:

2D min. code in mil	Distances in mm
4 mil	78 mm
6 mil	114 mm
10 mil	187 mm
14 mil	260 mm
20 mil	369 mm

DataMan 290 Reader with 16 mm Lens

The following tables show the Field of View (FoV) widths of the 16 mm lens at various distances.

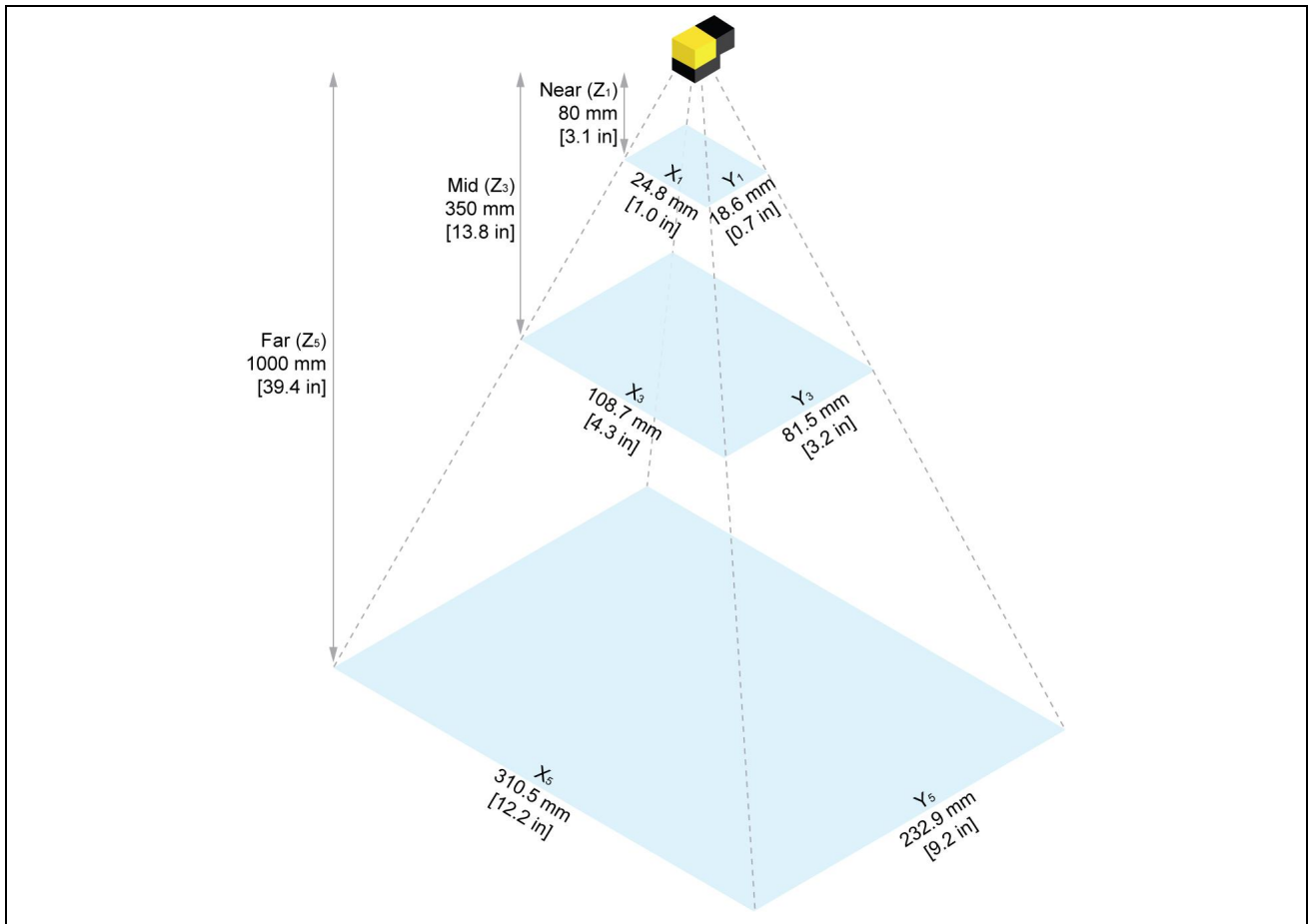

Working Distance	Horizontal Values	Vertical Values
80 mm [3.1 in]	24.8 mm [1.0 in]	18.6 mm [0.7 in]
350 mm [13.8 in]	108.7 mm [4.3 in]	81.5 mm [3.2 in]
1000 mm [39.4 in]	310.5 mm [12.2 in]	232.9 mm [9.2 in]

1D Field of View table with 16 mm Lens:

1D min. code in mil	Distances in mm
4 mil	417 mm
6 mil	613 mm
10 mil	1006 mm
14 mil	1398 mm
20 mil	1987 mm

2D Field of View table with 16 mm Lens:

2D min. code in mil	Distances in mm
4 mil	213 mm
6 mil	307 mm

2D min. code in mil	Distances in mm
10 mil	495 mm
14 mil	684 mm
20 mil	966 mm

Mounting the Reader

The reader provides mounting holes for attachment to a mounting surface.

CAUTION: You must ground the reader, either by mounting the reader to a fixture that is electrically grounded or by attaching a wire from the mounting fixture on the reader to frame ground or earth ground. If you use a ground wire, attach the wire to one of the four mounting points on the back plate of the reader and not to the mounting points on the front of the reader.

Align the holes on the mounting surface with the mounting holes on the reader. Insert the M3x9 screws into the mounting holes.

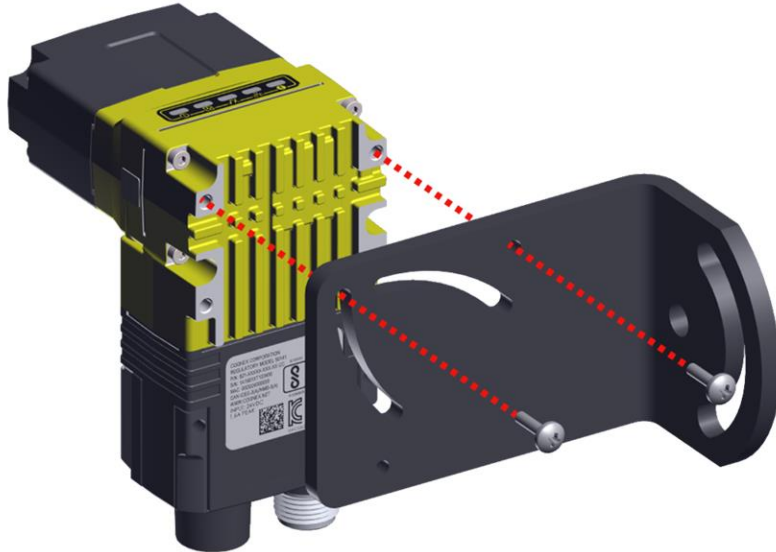

Note:
Use the top two holes for mounting the reader.

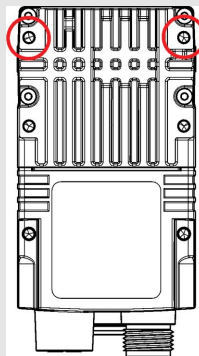

Connection Options

This section summarizes connection options.

For more information on how to connect your DataMan reader to your network, see the *DataMan Communications and Programming Guide*.

Connecting the Ethernet Cable

CAUTION: The Ethernet cable shield must be grounded at the far end. Whatever this cable is plugged into (typically a switch or router) should have a grounded Ethernet connector. A digital voltmeter should be used to validate the grounding. If the far end device is not grounded, a ground wire should be added in compliance with local electrical codes. The unit is to be connected only to internal Ethernet networks without exiting a facility and being subjected to TNVs.

1. Connect the M12 connector of the Ethernet cable to the reader ENET connector.
2. Connect the RJ-45 connector of the Ethernet cable to a switch/router or PC, as applicable.

Connecting the Power and I/O Breakout Cable

CAUTION: To reduce emissions, connect the far end of the Breakout cable shield to frame ground.

Note:



- Perform wiring or adjustments to I/O devices when the reader is not receiving power.
- You can clip unused wires short or use a tie made of non-conductive material to tie them back. Keep bare wires separated from the +24 V DC wire.

1. Verify that the 24 V DC power supply is unplugged and not receiving power.
2. Attach the +24 V DC connector of the Power and I/O Breakout cable and Ground wires to the corresponding terminals on the power supply. For more information, see [Specifications on page 31](#).

CAUTION: Never connect voltages other than 24 V DC. Always observe the polarity shown.

3. Attach the M12 connector of the Power and I/O Breakout Cable to the 24 V DC connector of the reader.
4. Restore power to the 24 V DC power supply and turn it on if necessary.

Power and I/O Breakout Cable (CCB-M12x12Fy-xx)

The Power and I/O Breakout cable provides access to trigger and high-speed outputs. For RS-232, use the Power Supply return path for ground.

The figure on the left shows the plug on the device.

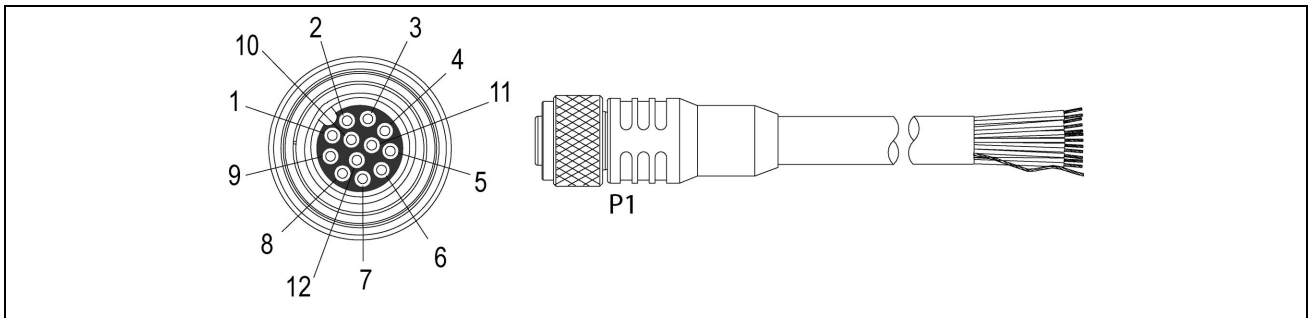

Pin#	Signal Names	Wire Color
1	Out 2/In 2	White
2	TxD	Green
3	RxD	Pink
4	Out 3/In 3	Yellow
5	In 1	Grey
6	Common In	Black
7	+24 VDC	Brown
8	GND	Blue
9	Common Out	Purple
10	In 0	Red
11	Out 0	Grey/Pink
12	Out 1	Red/Blue

Note:

- Cables are sold separately.

i

- Perform wiring or adjustments to I/O devices when the reader is not receiving power.
- You can cut exposed wires short or trim wire ends. You also can tie the wires back if you use a tie made of non-conductive material. Keep bare wires separated from the +24 V DC wire.

Using your DataMan 290 Reader Through USB

You can use the USB connector of the reader in the following ways:

- Emulating serial (USB-COM) functionality
The reader establishes the connection through emulated serial port.
- Emulating Ethernet functionality
The reader establishes the connection through emulated Ethernet.
- As Human Interface Device (HID)
If you use the reader in HID mode, the device serves as an emulated keyboard.

i Note: Do not power the reader exclusively over USB. Any load to the system might cause it to reboot.

Emulating Serial Functionality

If you connect a USB-C cable, you can see a COM port in the Windows Device Manager as a generic USB-COM port. The client application must have DTR (Data Terminal Ready) enabled.

To emulate serial functionality:

1. Set the **USB Connection** properties in the **Serial** tab of the **Communication Settings** panel in DataMan Setup Tool.
2. Open the Windows Device Manager to identify the proper device.
3. Enable the **Serial-over-USB** option in DataMan Setup Tool if it is disabled.

Emulating Ethernet Functionality

To emulate Ethernet-over-USB functionality, configure the connection between the PC and the reader.

The DataMan 290 has the fixed IP 192.168.111.2/24 through an emulated Ethernet connection.

Configure the PC-emulated Ethernet Driver to be in the Same LAN

1. Connect the PC to the reader with a USB-C cable.
2. Open **Control Panel** and select **Network and internet**.
3. Select **Network and Sharing Center**, then select **Change adapter settings**.
4. Identify the virtual adapter. On the example image below, it is Ethernet 5.

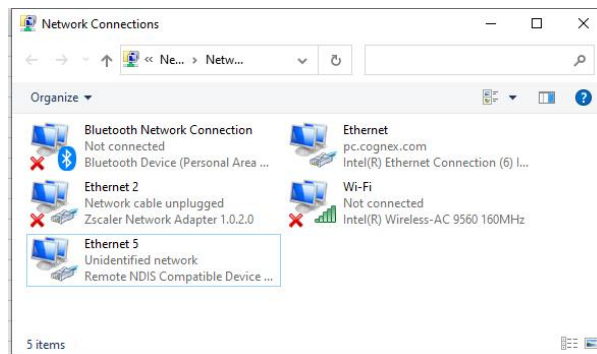

5. Right-click on the virtual adapter and select **Properties**.
6. Assign a fixed IP to the network adapter starting with 192.168.111.

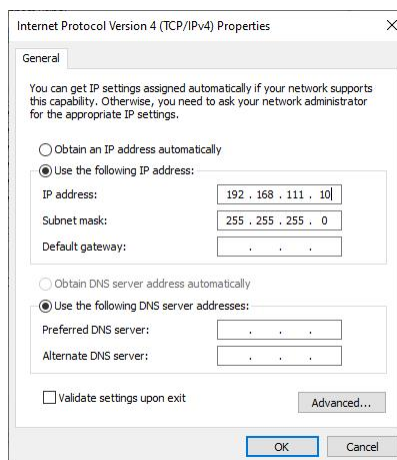

USB-Keyboard (HID) Functionality

To use the reader as an emulated keyboard, set the language of the keyboard in the software. HID reports use the keyboard language set in the dropdown menu.

You can configure HID functionality with both UI options available for the reader:

- To enable the HID interface with the DataMan WebUI, switch the toggle on the Communications substep:

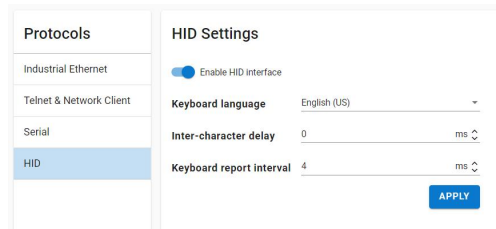

- To enable HID reports with the DataMan Setup Tool, check the **Enable HID reports** checkbox on the Communications application step:



Note:



- Communication through HID reports is similar to using a physical keyboard.
- Using keyboard emulation with applications supporting hotkeys can result in unexpected behavior, depending on the data of the read codes.

Using Your DataMan 290 Reader

This section provides information on the installation of the DataMan Setup Tool, troubleshooting connection issues, tuning, image filtering, as well as reader training and package detection.

Connect to DataMan WebUI

Connect to the DataMan WebUI using one of the following options:

Web browser

1. Open a web browser.
2. Enter any of the following details:
 - The IP address of your reader.
 - Serial number: found on the label of the reader, followed by `.local`. For example, `1A2436XN005610.local`.
 - MAC address: found on the label of the reader, followed by `.local`. For example, `00D0243BF53C.local`.
 - Host name: the default host name is `DM290` and the first six characters of the MAC address, followed by `.local`. For example, `DM290-00D024.local`.



Station Manager

1. Go to support.cognex.com/en/downloads/edge-intelligence and select Cognex Station Manager.
2. Download the Station Manager installer and follow the on-screen steps.
3. Find and select your reader.

- Click **Connect** and set up.

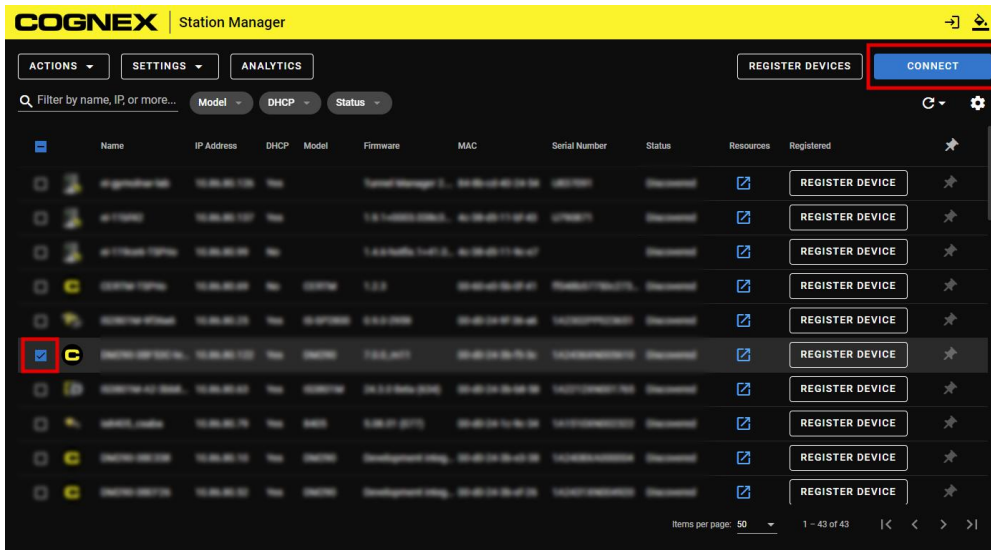

DataMan Setup Tool

- Follow the steps described in [Installing the DataMan Setup Tool on page 28](#).
- Right-click on your reader and select **Open WebUI In Browser**.

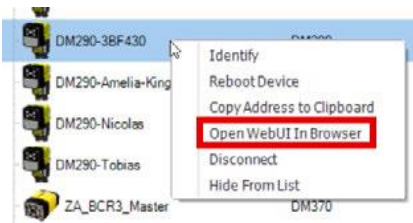

Installing the DataMan Setup Tool

Follow the steps below to install and connect your reader to the DataMan Setup Tool.

- Check the DataMan **Release Notes** for a full list of system requirements.
- Download the latest version of the DataMan Setup Tool from support.cognex.com/downloads/dataman/software-firmware and follow the on-screen steps.
- Connect the 290 series reader to your PC.
- Launch the DataMan Setup Tool and click **Refresh**. Detected devices appear under **COM ports** or **Network devices**, or both.
- Select a reader from the list and click **Connect**.

Trigger Types

The DataMan 290 readers support the following trigger modes:

- Self:** At an interval you configure, the reader automatically detects and decodes codes in its field of view. If you set a higher re-read delay than the trigger interval, there is a code output only once until the code is out of the field of view for the duration of the re-read delay.

- **Single** (external trigger): Acquires a single image and attempts to decode any symbol it contains, or more than one symbol in cases where multicode is enabled. The reader relies on an external trigger source.
- **Presentation**: Scans, decodes and reports a single code in the field of view. The reader relies on an internal timing mechanism to acquire images.
- **Manual**: Begins acquiring images when you press the trigger button on the reader, and continues acquiring images until a symbol is found and decoded or you release the button.
- **Burst** (external trigger): Performs multiple image acquisitions based on an external trigger and decodes any symbol appearing in a single image or within a sequence of images, or multiple symbols in a single image or within a sequence of images when multicode is enabled. You can control the number of images within each burst and the interval between image acquisitions.
- **Continuous** (external trigger): Begins acquiring images based on a single external trigger and continues to acquire and decode images until a symbol is found and decoded, or until multiple images containing as many codes as specified in multicode mode are located, or until the trigger is released. You can configure your reader to acquire images based on the start and stop signal from separate digital IO pulses.

External Triggers

If you are using external triggering, you can use any of the following methods to trigger your reader.

- Press the trigger button on the reader.



- Send a pulse on the I/O cable.
 - Trigger + (orange or red wire)
 - Trigger - (black wire)
- Send a serial trigger command over the RS-232 connection.
- Press **CTRL+T** on the keyboard while the DataMan Setup Tool has the input focus.
- Click the **Trigger** button in the DataMan Setup Tool or in the DataMan WebUI.

Industrial Protocols

The reader supports the following industrial protocols:

- EtherNet/IP™
- PROFINET
- SLMP Protocol
- Modbus TCP

Select industrial protocol samples and tools you want to use when you install the DataMan Setup Tool.

After enabling the selected industrial protocol, a reboot is required for the changes to take effect. Enable an industrial protocols on the reader with the following options:

- Enable the protocols on the **Communications** substep of the DataMan WebUI.
- Enable the protocols using the **Industrial Protocols** pane of the DataMan Setup Tool, under **Communications**.
- Scan the appropriate **Reader Configuration codes**. For more information, see *Reader Configuration Codes* available through the Windows **Start** menu, the DataMan Setup Tool **Help** menu, or DataMan documentation available on the [Cognex support site](#).
- Send the appropriate **DMCC** command. For more information, see *Command Reference* available through the Windows **Start** menu or the DataMan Setup Tool **Help** menu.

For more information on using the industrial protocols, see the *DataMan Industrial Protocols Manual* available through the Windows **Start** menu, the DataMan Setup Tool **Help** menu, or DataMan documentation available on the [Cognex support site](#).

Specifications

The following sections list general specifications for the reader.

DataMan 290 Series Reader

Specification	DataMan 290
Weight	DataMan 290 with: <ul style="list-style-type: none"> • Multi-Purpose Integrated Light 6.2 mm Model: 214 g • Multi-Purpose Integrated Light 16 mm Model: 234 g • Mini Light 6.2 mm Model: 169 g • Mini Light 16 mm Model: 194 g
Power	External LPS or NEC Class 2 power supply power supply: 24 V DC +/- 10%
Power Consumption	Average: $\leq 7.5W$ Maximum: 1.6 A
Sensor Temperature	0 – 70°C (32 – 158°F) <div style="border: 1px solid black; padding: 5px;"> <p>Note: Use the temperature readout in the DataMan WebUI to verify sensor temperature. If the  sensor temperature exceeds 70°C, you must implement additional cooling measures. For example, mount the reader to a heat sink, or reduce ambient temperature.</p> </div>
Operating Temperature	0 - 40°C (32 – 104°F)
Storage Temperature	-20°C – 80°C
Humidity	< 95% non-condensing
Environmental	Altitude: 2000 m, indoor use only, pollution degree II
Shock (Shipping and Storage)	IEC 60068-2-27: 1000 shocks, semi-sinusoidal, 11 g, 10 ms ISTA-1A Standardized Testing - Packaged Products 150 lb or less
Vibration (Shipping and Storage)	IEC 60068-2-6: vibration test in each of the three main axis for 2 hours @ 10 Gs (10 to 500 Hz at 100m/s ² / 15 mm) FedEx Vibration Testing for packaged products 150 lbs or less
RS-232	RxD, TxD according to TIA/EIA-232-F
USB	USB 2.0, Device Configuration Mode
Codes	1-D barcodes: Codabar, Code 39, Code 128, Code 93, Code 25, Interleaved 2 of 5, Postal Codes, UPC/EAN/JAN, MSI 2-D barcodes: Data Matrix (IDMax and IDQuick: ECC 0, 50, 80, 100, 140, and 200), QR Code, microQR, PDF 417, AztecCode, DotCode, MaxiCode
High-Speed Outputs	I_{MAX} : 50 mA V_{OL} : $\leq \pm 3 V @ 50 mA$
Trigger	V_{IL} : $\leq \pm 6 V$

Specification	DataMan 290
Inputs	$V_{IH}: \geq \pm 12\text{ V}$
	$I_{TYP}: 4.2\text{ mA @ } 24\text{ V}$
Ethernet	10/100 BASE-T. Full duplex or half duplex. IEEE802.3

DataMan 290 Series Reader Image Sensor

Specification	Values
Image Sensor	1/3-inch CMOS, global shutter
Image Sensor Properties	Diagonal size: 6.21 mm Pixel size: 3.45 μm (H)
Image Resolution (pixels)	1440 \times 1080 (1.6 mp)
Electronic Shutter Speed	Minimum exposure: 43 μs Maximum exposure: 200 ms (with external illumination)
Image Acquisition at Full Resolution	Maximum: 45 Hz
Lens Type	<ul style="list-style-type: none"> 6.2 mm (3 pos or LLM) with IR blocking filter 16 mm (manual or LLM) with IR blocking filter

LED Wavelengths

The following table shows LED types and the related peak wavelengths.

Illumination	Illustration	LED	Color Temperature / λ [nm]
Multi-Purpose Integrated Light		Red	620 λ (nm)
		White	4000 K (Color Temperature)
Mini Light		Red	617 λ (nm)

Acquisition Trigger Input

The reader features one acquisition trigger input, which is optically isolated. You can configure the acquisition trigger input to trigger from an NPN (current sinking) or PNP (current sourcing) device.

- To trigger from an NPN type photoelectric sensor or PLC output, connect COMMON IN to +24 V DC and connect IN 0 to the output of the photoelectric sensor. When the output turns ON, it pulls TRIGGER down to 0 V DC, turning the opto-coupler ON.
- To trigger from a PNP photoelectric sensor or PLC output, connect IN 0 to the output of the photoelectric sensor and connect COMMON IN to 0 V DC. When the output turns ON, it pulls TRIGGER up to +24 V DC, turning the opto-coupler ON.

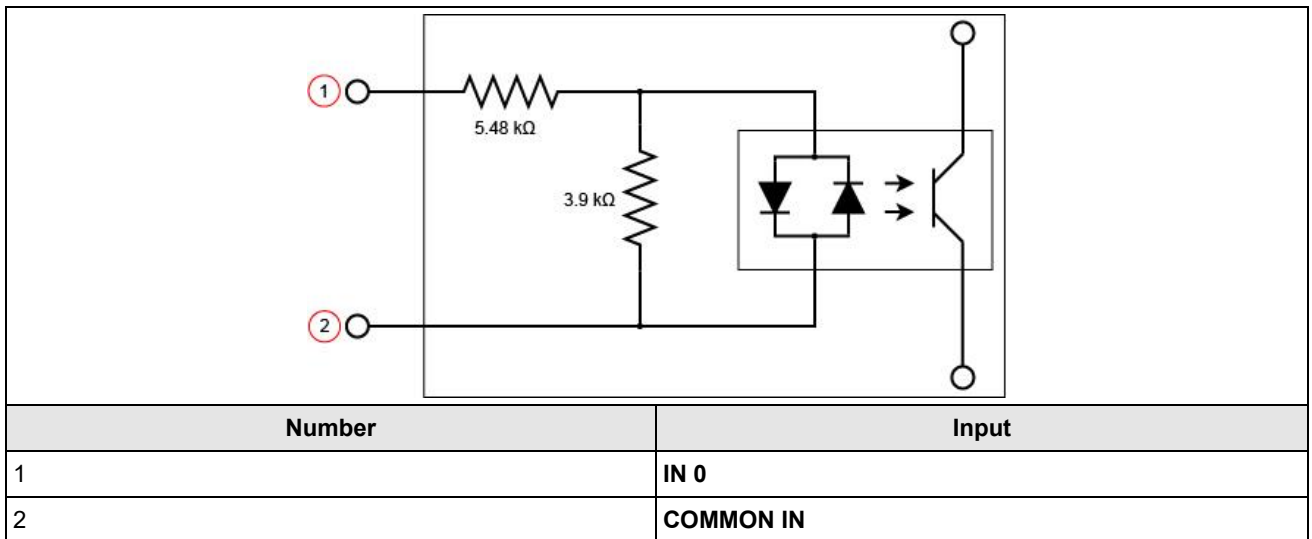

High-Speed Outputs

Specification	Description
Voltages	V_{MAX} : 26 V DC through external load V_{OL} : $\leq \pm 3$ V @ 50 mA
Current	I_{MAX} : 50 mA maximum sink or source current Each line is protected against over-current, short circuits and transients from switching inductive loads. High current inductive loads require an external protection diode.

For NPN lines, connect the external load between the output and the positive supply voltage (< 26 V DC). The output pulls down to less than 3 V DC when ON, which causes current to flow through the load. When the output is OFF, no current flows through the load.

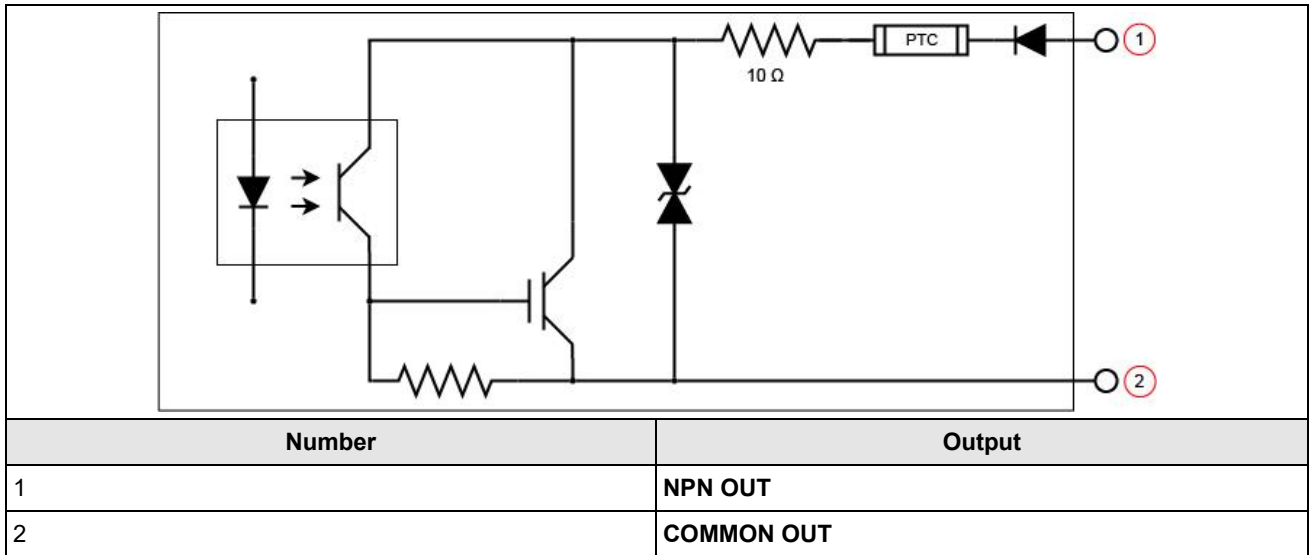

For PNP lines, connect the external load between the output and the negative supply voltage (0 V DC). When connected to a 24 V DC power supply, the output pulls up greater than 21 V DC when ON, and current flows through the load. When the output is OFF, no current flows through the load.

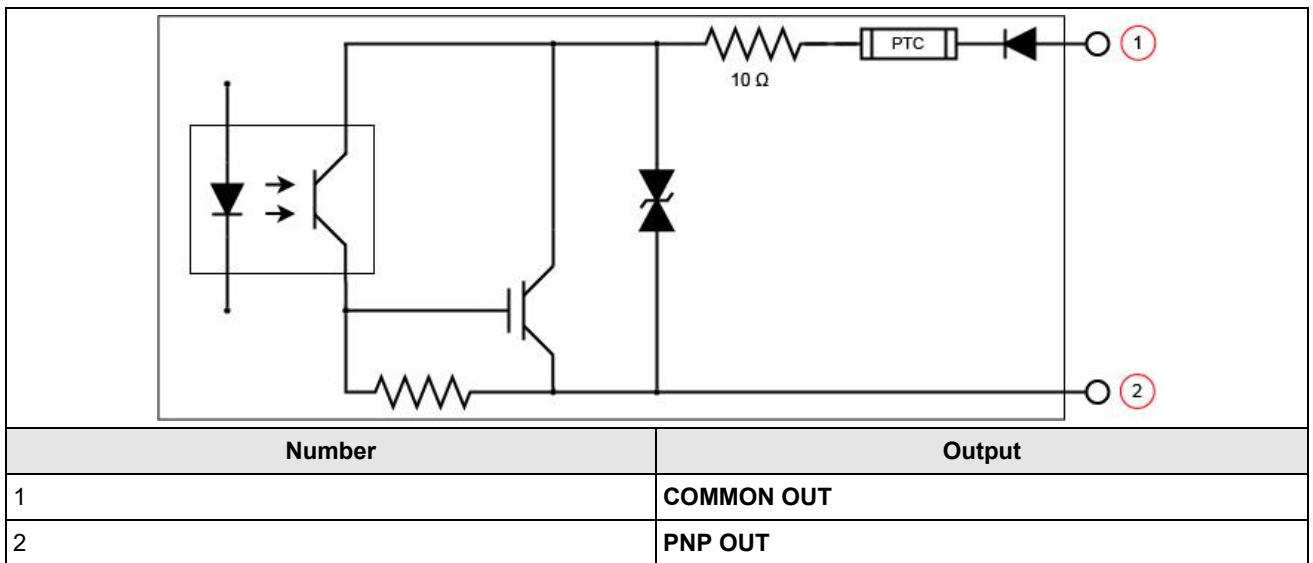

High Speed Output Wiring

To connect to an NPN-compatible PLC input, connect one of the high-speed outputs of the reader directly to the PLC input. When enabled, the output pulls the PLC input down to less than 3 V DC.

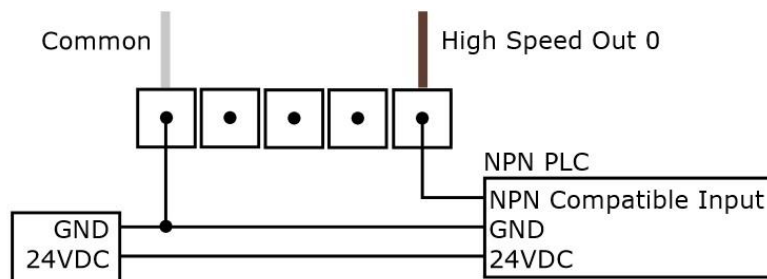

To connect to a PNP-compatible PLC input, connect one of the high-speed outputs of the reader directly to the PLC input. When enabled, the output pulls the PLC input up to greater than 21 V DC.

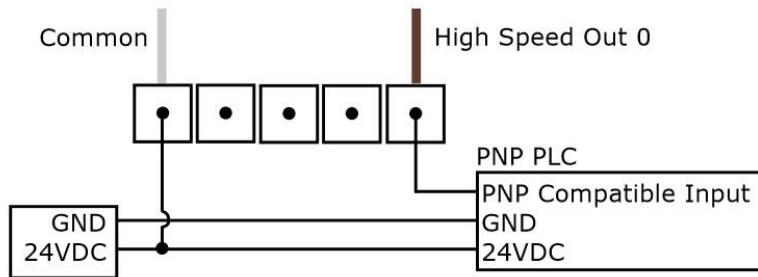

To connect the high-speed outputs to a relay, LED or similar load, connect the negative side of the load to the output and the positive side to +24 V DC. When the output switches on, the negative side of the load is pulled down to less than 3 V DC, and 21 V DC appears across the load. Use a protection diode for a large inductive load, with the anode connected to the output and the cathode connected to +24 V DC.

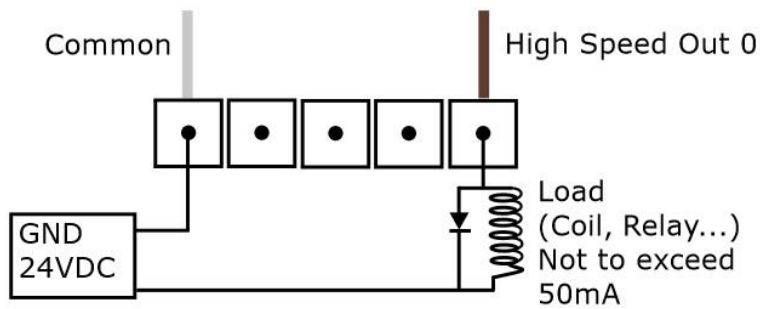

Ethernet Cable

The Ethernet cable provides Ethernet connectivity to the reader. The Ethernet cable is used to connect the reader to other network devices.

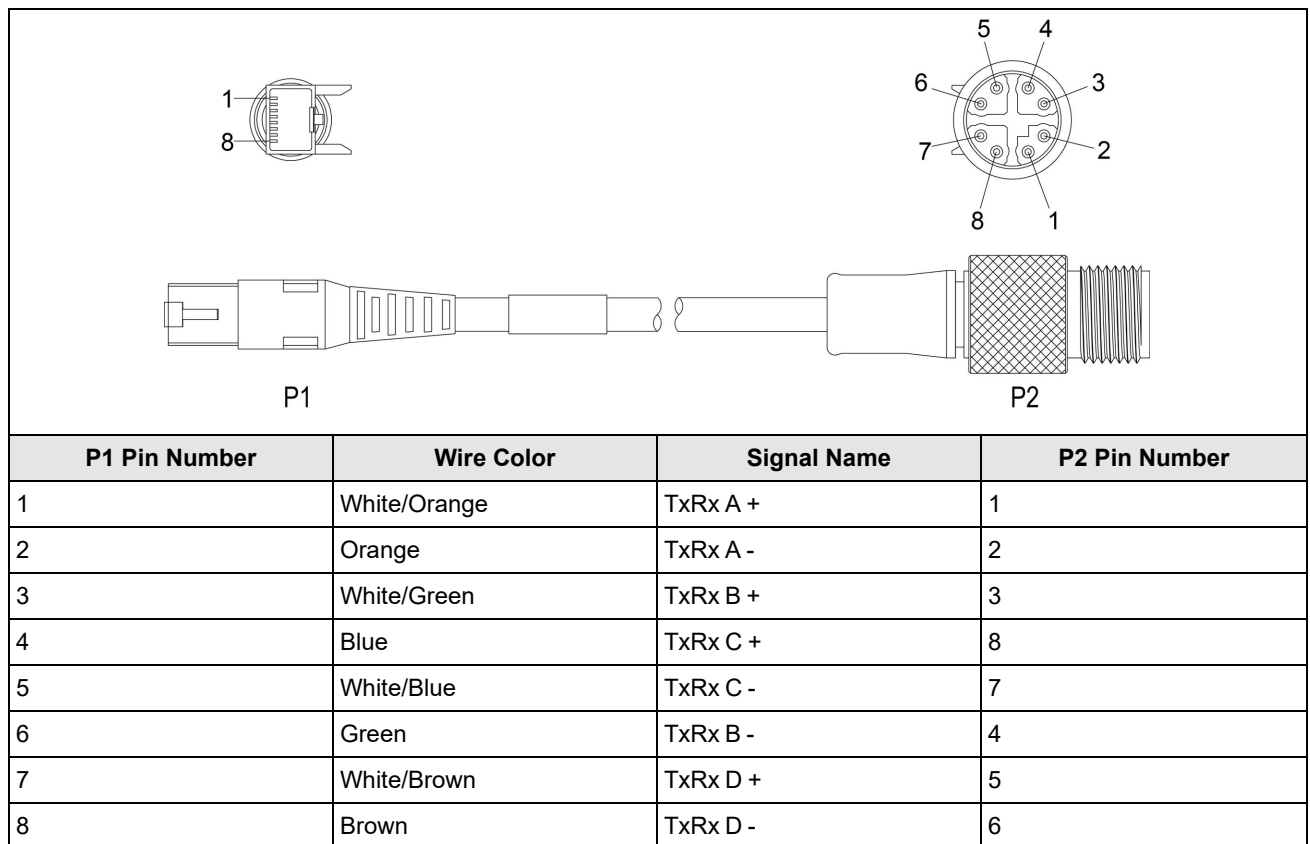

CAUTION: The Ethernet cable shield must be grounded at the far end. Whatever this cable is plugged into (typically a switch or router) should have a grounded Ethernet connector. A digital voltmeter should be used to validate the grounding. If the far end device is not grounded, a ground wire should be added in compliance with local electrical codes.

Note:

- Cables are sold separately.
- The wiring for this cable follows standard industrial Ethernet M12 specifications. It differs from the 568B standard.

Power and I/O Breakout Cable (CCB-M12x12Fy-xx)

The Power and I/O Breakout cable provides access to trigger and high-speed outputs. For RS-232, use the Power Supply return path for ground.

The figure on the left shows the plug on the device.

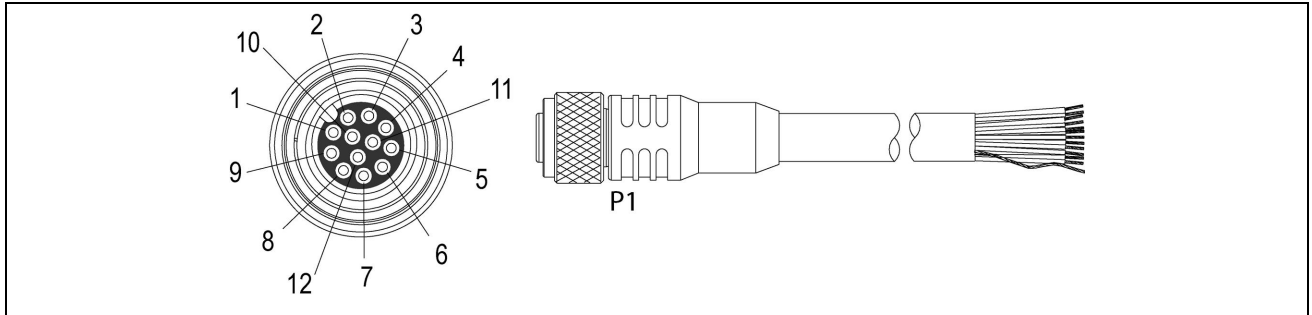

Pin#	Signal Names	Wire Color
1	Out 2/In 2	White
2	TxD	Green
3	RxD	Pink
4	Out 3/In 3	Yellow
5	In 1	Grey
6	Common In	Black
7	+24 VDC	Brown
8	GND	Blue
9	Common Out	Purple
10	In 0	Red
11	Out 0	Grey/Pink
12	Out 1	Red/Blue

Note:

- Cables are sold separately.



- Perform wiring or adjustments to I/O devices when the reader is not receiving power.
- You can cut exposed wires short or trim wire ends. You also can tie the wires back if you use a tie made of non-conductive material. Keep bare wires separated from the +24 V DC wire.

Power and I/O Breakout Cable (CCBL-05-01)

The Power and I/O Breakout cable provides access to trigger and high-speed outputs. For RS-232, use the Power Supply return path for ground.

The figure on the left shows the plug on the device.

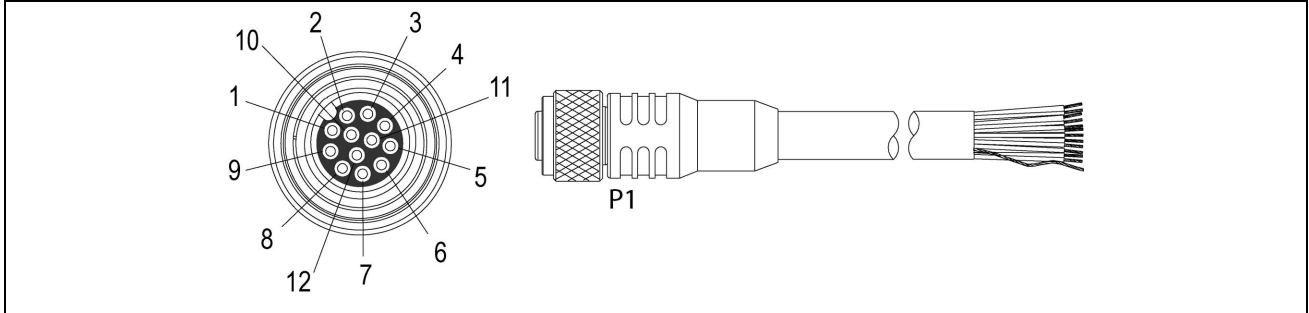

Pin#	Signal Names	Wire Color
1	Out 2/In 2	Yellow
2	TxD	White/Yellow
3	RxD	Brown
4	Out 3/In 3	White/Brown
5	In 1	Violet
6	Common In	White/Violet
7	+24 VDC	Red
8	GND	Black
9	Common Out	Green
10	In 0	Orange
11	Out 0	Blue
12	Out 1	Grey

Note:

- Cables are sold separately.



- Perform wiring or adjustments to I/O devices when the reader is not receiving power.
- You can cut exposed wires short or trim wire ends. You also can tie the wires back if you use a tie made of non-conductive material. Keep bare wires separated from the +24 V DC wire.

Power and I/O Breakout Cable (CCB-PWRIO-xx)

The Power and I/O Breakout cable provides access to trigger and high-speed outputs. For RS-232, use the Power Supply return path for ground.

The figure on the left shows the plug on the device.

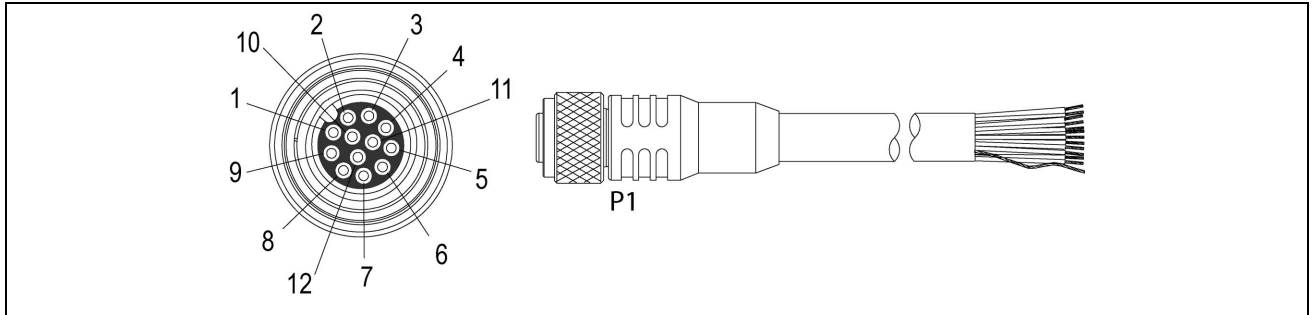

Pin#	Signal Names	Wire Color
1	Out 2/In 2	Yellow
2	TxD	White/Yellow
3	RxD	Brown
4	Out 3/In 3	White/Brown
5	In 1	Violet
6	Common In	White/Violet
7	+24 VDC	Red
8	GND	Black
9	Common Out	Green
10	In 0	Orange
11	Out 0	Blue
12	Out 1	Grey

Note:

- Cables are sold separately.
- Perform wiring or adjustments to I/O devices when the reader is not receiving power.
- You can cut exposed wires short or trim wire ends. You also can tie the wires back if you use a tie made of non-conductive material. Keep bare wires separated from the +24 V DC wire.



Cleaning and Maintenance

Clean the Housing

To clean the outside of the reader housing, use a small amount of mild detergent cleaner or isopropyl alcohol on a cleaning cloth. Do not pour the cleaner on the reader housing.

 **CAUTION:** Do not attempt to clean any DataMan product with harsh or corrosive solvents, including lye, methyl ethyl ketone (MEK) or gasoline.

Clean the Reader Image Sensor Window

To remove dust from the outside of the image sensor window, use a pressurized air duster. The air must be free of oil, moisture or other contaminants that could remain on the glass and possibly degrade the image. Do not touch the glass window. If oil or smudges remain, use a cotton bud and alcohol (ethyl, methyl, or isopropyl) to clean the window. Do not pour the alcohol on the window.



Clean the Reader Lens Cover

To remove dust from the lens cover, use a pressurized air duster. The air must be free of oil, moisture or other contaminants that could remain on the lens cover. To clean the plastic window of the lens cover, use a small amount of isopropyl alcohol on a cleaning cloth. Do not scratch the plastic window. Do not pour the alcohol on the plastic window.

Regulations and Conformity

Note: For the most current CE and UKCA declaration and regulatory conformity information, see the Cognex support site: cognex.com/support.

The DataMan 290 reader has the Regulatory Model 50141 and meets or exceeds the requirements of all applicable standards organizations for safe operation. However, as with any electrical equipment, the best way to ensure safe operation is to operate them according to the agency guidelines that follow. Please read these guidelines carefully before using your reader.

Safety and Regulatory	
Manufacturer	Cognex Corporation One Vision Drive Natick, MA 01760 USA
	DataMan 290: Regulatory Model 50141 This is a class A product. In a domestic environment this product may cause radio interference in which case the user may be required to take immediate measures. This equipment complies with the essential requirements of the EU Directive 2014/30/EU. Declarations are available from your local representative.
EU RoHS	Compliant to the most recent applicable directive.
FCC	FCC Part 15, Class A This equipment has been tested and found to comply with the limits for a Class A digital device, pursuant to part 15 of the FCC Rules. These limits are designed to provide reasonable protection against harmful interference when the equipment is operated in a commercial environment. This equipment generates, uses, and can radiate radio frequency energy and, if not installed and used in accordance with the instruction manual, may cause harmful interference to radio communications. Operation of this equipment in a residential area is likely to cause harmful interference in which case the user will be required to correct the interference at his own expense.
Korea 	DataMan 290: Regulatory Model R-R-CGX-50141 This device is certified for office use only and if used at home, there can be frequency interference problems.
UL, TÜV SÜD	DataMan 290: Regulatory Model 50141
	NRTL: NRTL OSHA Scheme for UL/CAN 61010-1, UL E-File Number: E541651
	CB report available upon request. IEC/EN 61010-1.
	Regulator Model 50141 This is a class A product. In a domestic environment this product may cause radio interference in which case the user may be required to take immediate measures. This equipment complies with the essential requirements of the Electromagnetic Compatibility Regulations 2016. Declarations are available from your local representative.

中国大陆RoHS (Information for China RoHS Compliance)

根据中国大陆《电子信息产品污染控制管理办法》(也称为中国大陆RoHS), 以下部份列出了本产品中可能包含的有毒有害物质或元素的名称和含量。



	Hazardous Substances 有害物质					
Part Name 部件名称	Lead (Pb) 铅	Mercury (Hg) 汞	Cadmium (Cd) 镉	Hexavalent Chromium (Cr (VI)) 六价铬	Polybrominated biphenyls (PBB) 多溴联苯	Polybrominated diphenyl ethers (PBDE) 多溴二苯醚
Regulatory Model 50141	X	O	O	O	O	O

This table is prepared in accordance with the provisions of SJ/T 11364.

这个标签是根据SJ/T 11364 的规定准备的。

O: Indicates that said hazardous substance contained in all of the homogeneous materials for this part is below the limit requirement of GB / T26572 - 2011.

表示本部件所有均质材料中含有的有害物质低于GB / T26572 - 2011 的限量要求。

X: Indicates that said hazardous substance contained in at least one of the homogeneous materials used for this part is above the limit requirement of GB / T26572 - 2011.

表示用于本部件的至少一种均质材料中所含的危害物质超过GB / T26572 - 2011 的限制要求。

For European Community Users

Cognex complies with Directive 2012/19/EU OF THE EUROPEAN PARLIAMENT AND OF THE COUNCIL of 4 July 2012 on waste electrical and electronic equipment (WEEE).

This product has required the extraction and use of natural resources for its production. It may contain hazardous substances that could impact health and the environment, if not properly disposed.

In order to avoid the dissemination of those substances in our environment and to diminish the pressure on the natural resources, we encourage you to use the appropriate take-back systems for product disposal. Those systems will reuse or recycle most of the materials of the product you are disposing in a sound way.



The crossed out wheeled bin symbol informs you that the product should not be disposed of along with municipal waste and invites you to use the appropriate separate take-back systems for product disposal.

If you need more information on the collection, reuse, and recycling systems, please contact your local or regional waste administration.

You may also contact your supplier for more information on the environmental performance of this product.

