

## DataMan<sup>®</sup> 290 Series Quick Reference Guide

2025 December 17  
Revision: 25.4.1.1



# Precautions

To reduce the risk of injury or equipment damage, observe the following precautions when you install the Cognex product:

- The reader requires a UL or NTRL listed power supply with a 24 V DC output that meets the following rating requirements:
  - 24 V DC (+/- 10%) output connection using a UL or NTRL listed LPS or NEC Class 2 power supply power supply

Any other voltage creates a risk of fire or shock and can damage the components. Applicable national and local wiring standards and rules must be followed.

- This product is intended for industrial use in automated manufacturing or similar applications.
- The safety of any system incorporating this product is the responsibility of the assembler of the system.
- Do not install Cognex products where they are exposed to environmental hazards such as excessive heat, dust, moisture, humidity, impact, vibration, corrosive substances, flammable substances, or static electricity.
- Route cables and wires away from high-current wiring or high-voltage power sources to reduce the risk of damage or malfunction from the following causes: over-voltage, line noise, electrostatic discharge (ESD), power surges, or other irregularities in the power supply.
- Do not expose the image sensor to laser light. Image sensors can be damaged by direct, or reflected, laser light. If your application requires laser light that might strike the image sensor, use a lens filter at the corresponding laser wavelength. For suggestions, contact your local integrator or application engineer.

- This product does not contain user-serviceable parts. Do not make electrical or mechanical modifications to product components. Unauthorized modifications can void your warranty.
- Changes or modifications not expressly approved by the party responsible for regulatory compliance could void the user's authority to operate the equipment.
- All cables connected to device need to be certified for CYJV or PVVA.
- Include service loops with cable connections.
- Ensure that cable strain relief is applied within strain relief zone. The strain relief zone is between two inches to six inches from the connector.
- Ensure that the cable bend radius begins at least six inches from the connector. Cable shielding can be degraded or cables can be damaged or wear out faster if a service loop or bend radius is tighter than 10X the cable diameter.
- This device should be used in accordance with the instructions in this manual.
- All specifications are for reference purposes only and can change without notice.

# Symbols

The following symbols indicate safety precautions and supplemental information:



**WARNING:** This symbol indicates a hazard that could cause death, serious personal injury or electrical shock.

---



**CAUTION:** This symbol indicates a hazard that could result in property damage.

---



**Note:** This symbol indicates additional information about a subject.





---



**Tip:** This symbol indicates suggestions and shortcuts that might not otherwise be apparent.

---

# DataMan 290 Series Systems

Illustration	Product ID		Illumination	Lens	Front Cover
	Reader-only	Accessory Bundle			
	DM290X-16-LM	DM290X-16-LM-05	Multi-Purpose Integrated Light	16 mm high-speed liquid lens	Clear, polarized, diffuse
	DM290X-06-LM	DM290X-06-LM-05	Multi-Purpose Integrated Light	6.2 mm high-speed liquid lens	Clear, polarized, diffuse
	DM290X-16-SP	DM290X-16-SP-05	Mini Light	16 mm high-speed liquid lens	Half-polarized
	DM290X-06-SC	DM290X-06-SC-05	Mini Light	6.2 mm high-speed liquid lens	Clear



The accessory bundles include the following items:

- Power and I/O breakout cable (CCB-PWRIO-05)
- Ethernet cable (CCB-84901-2001-05)
- Mounting bracket (DM290-UBRK-000)

# Accessories

You can purchase the following components separately. For a list of options and accessories, contact your local Cognex sales representative.

## Lenses

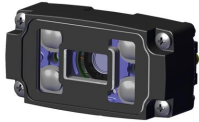

Accessory	Illustration
6.2 mm lens	 A 3D rendering of a Cognex camera head with a 6.2 mm lens. The camera head is black with a prominent lens in the center. Below the camera head is a separate black lens cap.
16 mm lens	 A 3D rendering of a Cognex camera head with a 16 mm lens. The camera head is black with a prominent lens in the center.

# Illumination

Accessory	Illustration	Color	Maximum Exposure time	Maximum Duty Cycle	
				2 Active LEDs	4 Active LEDs
Multi-Purpose Integrated Light		Red (clear and half-polarized light)	10 ms	10%	6%
		White (diffused light)			
Mini Light		Red (6.2 mm model)			
		Red (16 mm model)			







# Mounting Brackets







**i Note:** The backside of the reader needs to be connected to a metal part that can serve as a heatsink.

Accessory	Product Number	Illustration
Universal mounting bracket	DM290-UBRK-000	 A black, L-shaped universal mounting bracket. It has a flat base with a circular hole and a vertical backplate with a semi-circular cutout at the top.
Pivot mounting bracket	DM100-PIVOTM-01	 A blue, U-shaped pivot mounting bracket. It has a central pivot point and two curved ends with mounting holes.

## Cables

**Note:** Cables are sold separately or as part of an accessory bundle. For more information, contact your Cognex sales representative.

Accessory	Product Number	Illustration
Ethernet Cable, X-coded M12-8 to RJ-45	CCB-84901-2001-xx (straight, xx specifies length: 2m, 5m, 10m, 15m, 30m)	
Ethernet Cable, X-coded M12-8 to RJ-45	CCB-84901-2002-xx (right-angled, xx specifies length: 2m, 5m, 10m)	
Ethernet Cable, Robotic X-Coded M12-8 to RJ-45	CCB-84901-2RBT-xx (straight, xx specifies length: 2m, 5m, 10m)	
X-Coded to A-Coded Ethernet cable adapter, 0.5 m	CCB-M12X8MS-XCAC	
Power and I/O Breakout Cable, M12-12 to Flying Lead	CCB-M12x12Fy-05 (y = straight/angled, xx specifies length)	
Power and I/O Breakout Cable, M12-12 to Flying Lead	CCBL-05-01	
Power and I/O Breakout Cable, M12-12 to Flying Lead	CCB-PWRIO- xx (straight, xx specifies length: 5m, 10m, 15m)	

Accessory	Product Number	Illustration
Power and I/O Breakout Cable, M12-12 to Flying Lead	CCB-PWRIO-xxR (right-angled, xx specifies length: 5m, 10m, 15m)	
Power and I/O Breakout Cable, M12-12 to DB15	CCB-PWRIO-MOD-xx (xx specifies length: 2m, 5m)	
RS-232 Connection Cable	CCB-M12xDB9Y-05	
I/O Extension Cable	CKR-200-CBL-EXT	
Sealed USB Type C Cable to USB Type A, Straight, 2.5 m	DMA-STCBLE-IP65-25	
Sealed USB Type C Cable to USB Type A, Straight 3.6 m	DMA-STCBLE-IP65-36	
Sealed USB Type C Cable to USB Type A, Angled, 2.5 m	DMA-RTCBLE-IP65-25	
Sealed USB Type C Cable to USB Type A, Angled, 3.6 m	DMA-RTCBLE-IP65-36	

# Setting Up Your DataMan 290 Reader

Read this section to learn how the reader connects to its standard components and accessories.

**CAUTION:** All cable connectors are keyed to fit the connectors on the reader. Do not force the connections or damage may occur.

## DataMan 290 Layout

The image and table below shows the elements of the reader.

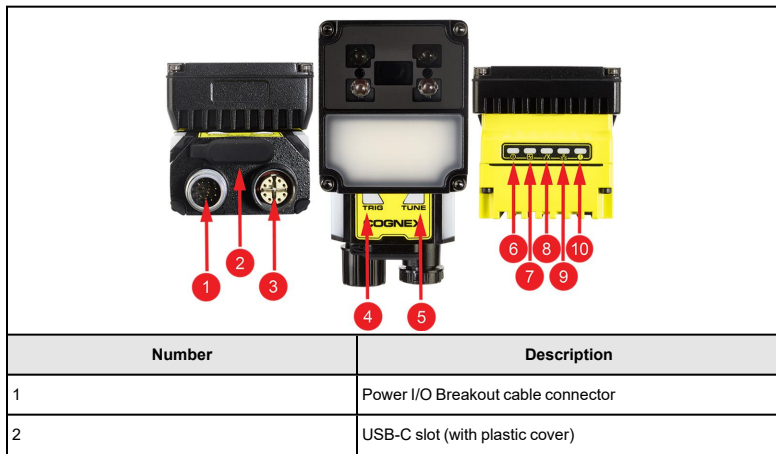

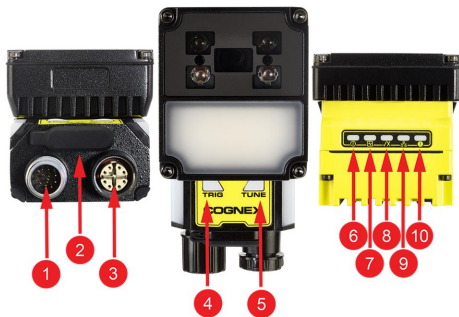

Number	Description
3	Ethernet connector
4	Trigger button
5	Tune button
6	Power LED indicator
7	Train status/Trigger status LED indicator
8	Good/bad read LED indicator
9	Communication LED indicator
10	Error LED indicator

## Dimensions

The following sections list dimensions of the reader.

**Note:**



- Dimensions are in millimeters and are for reference purposes only.
- All specifications are for reference purposes only and can change without notice.

# DataMan 290 with Multi-Purpose Integrated Light and 6.2 mm Lens

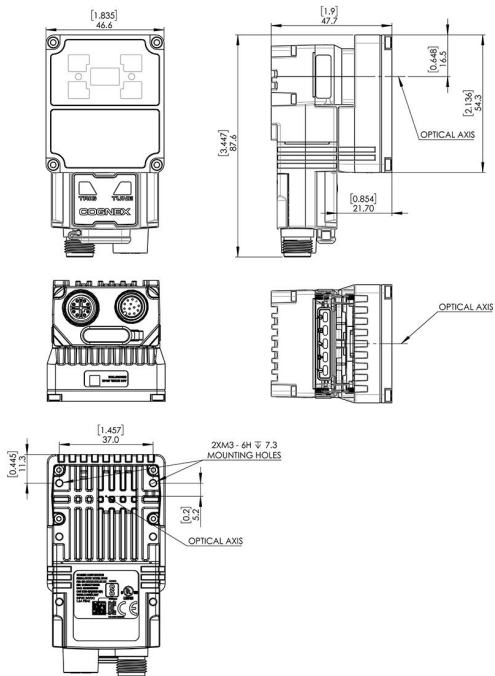

# DataMan 290 with Multi-Purpose Integrated Light and 16 mm Lens

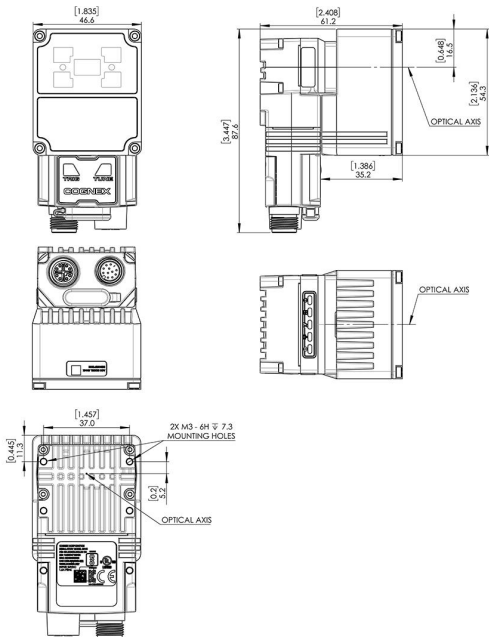

# DataMan 290 with Mini Light and 6.2 mm Lens

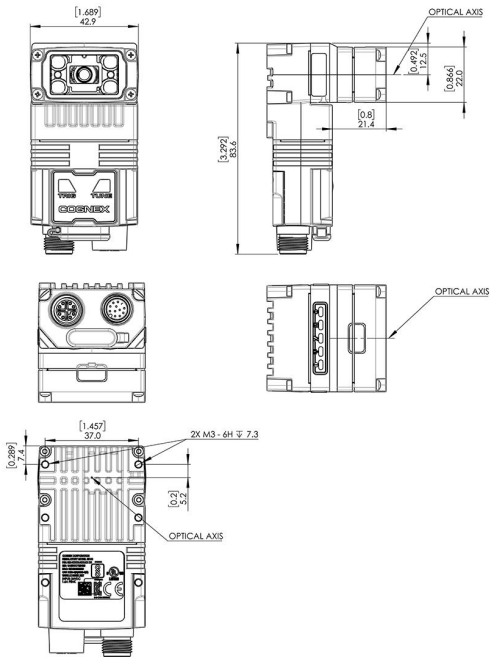

# DataMan 290 with Mini Light and 16 mm Lens

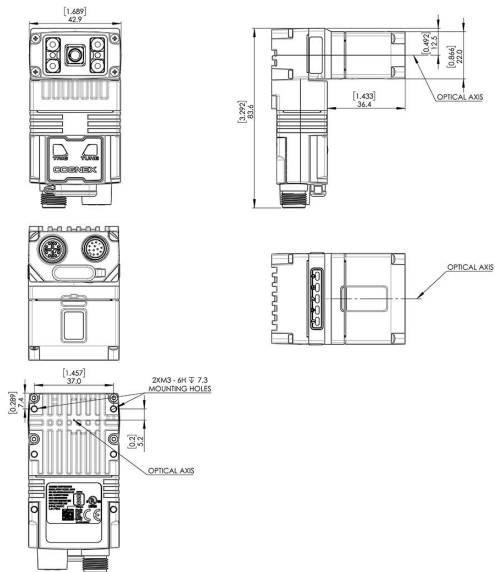

## Field of View and Working Distance

This section provides the Field of View (FoV) values for 6.2 mm and 16 mm lenses.

### DataMan 290 Reader with 6.2 mm Lens

The following tables show the Field of View (FoV) widths of the 6.2 mm lens at various distances.

**Note:**

The 6.2 mm lens has two default focus distances that provide the same FoV at different working distance ranges:



- Short-range focus at 105 mm for 65–200 mm working distance.
- Far-range focus at 190 mm for 80–500 mm working distance.

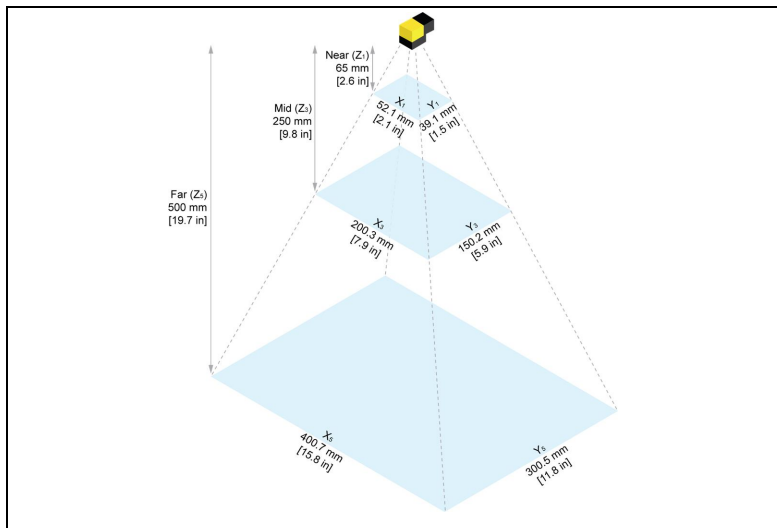

Working Distance	Horizontal Values	Vertical Values
65 mm [2.6 in]	52.1 mm [2.1 in]	39.1 mm [1.5 in]
250 mm [9.8 in]	200.3 mm [7.9 in]	150.2 mm [5.9 in]
500 mm [19.7 in]	400.7 mm [15.8 in]	300.5 mm [11.8 in]

1D Field of View table with 6.2 mm Lens:

1D min. code in mil	Distances in mm
4 mil	157 mm
6 mil	233 mm
10 mil	385 mm
14 mil	537 mm
20 mil	765 mm

2D Field of View table with 6.2 mm Lens:

2D min. code in mil	Distances in mm
4 mil	78 mm
6 mil	114 mm
10 mil	187 mm
14 mil	260 mm
20 mil	369 mm

## DataMan 290 Reader with 16 mm Lens

The following tables show the Field of View (FoV) widths of the 16 mm lens at various distances.

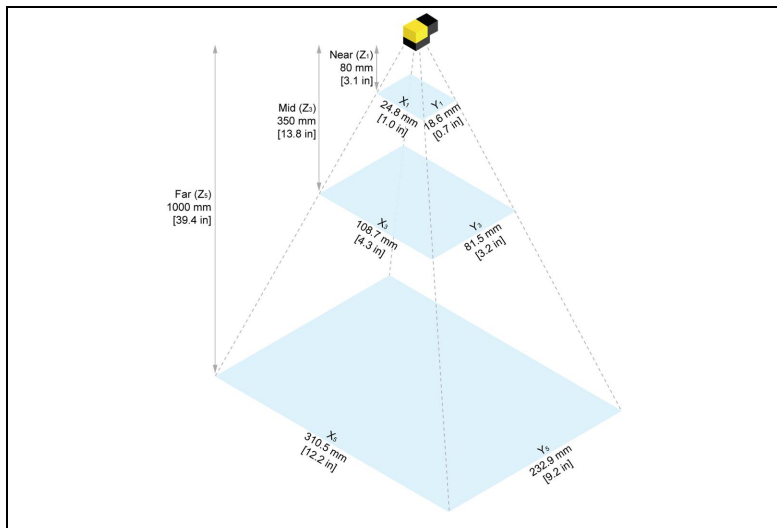

Working Distance	Horizontal Values	Vertical Values
80 mm [3.1 in]	24.8 mm [1.0 in]	18.6 mm [0.7 in]
350 mm [13.8 in]	108.7 mm [4.3 in]	81.5 mm [3.2 in]
1000 mm [39.4 in]	310.5 mm [12.2 in]	232.9 mm [9.2 in]

1D Field of View table with 16 mm Lens:

<b>1D min. code in mil</b>	<b>Distances in mm</b>
4 mil	417 mm
6 mil	613 mm
10 mil	1006 mm
14 mil	1398 mm
20 mil	1987 mm

2D Field of View table with 16 mm Lens:

<b>2D min. code in mil</b>	<b>Distances in mm</b>
4 mil	213 mm
6 mil	307 mm
10 mil	495 mm
14 mil	684 mm
20 mil	966 mm

## Connecting the Ethernet Cable

---

**CAUTION:** The Ethernet cable shield must be grounded at the far end. Whatever this cable is plugged into (typically a switch or router) should have a grounded Ethernet connector. A digital voltmeter should be used to validate the grounding. If the far end device is not grounded, a ground wire should be added in compliance with local electrical codes. The unit is to be connected only to internal Ethernet networks without exiting a facility and being subjected to TNVs.



1. Connect the M12 connector of the Ethernet cable to the reader ENET connector.
2. Connect the RJ-45 connector of the Ethernet cable to a switch/router or PC, as applicable.

## Connecting the Power and I/O Breakout Cable

---

**CAUTION:** To reduce emissions, connect the far end of the Breakout cable shield to frame ground.



### Note:



- Perform wiring or adjustments to I/O devices when the reader is not receiving power.
  - You can clip unused wires short or use a tie made of non-conductive material to tie them back. Keep bare wires separated from the +24 V DC wire.
1. Verify that the 24 V DC power supply is unplugged and not receiving power.

2. Attach the +24 V DC connector of the Power and I/O Breakout cable and Ground wires to the corresponding terminals on the power supply. For more information, see *Specifications* on page 26.



**CAUTION:** Never connect voltages other than 24 V DC. Always observe the polarity shown.

---

3. Attach the M12 connector of the Power and I/O Breakout Cable to the 24 V DC connector of the reader.
4. Restore power to the 24 V DC power supply and turn it on if necessary.

## Using your DataMan 290 Reader Through USB

You can use the USB connector of the reader in the following ways:

- Emulating serial (USB-COM) functionality

The reader establishes the connection through emulated serial port.

- Emulating Ethernet functionality

The reader establishes the connection through emulated Ethernet.

- As Human Interface Device (HID)

If you use the reader in HID mode, the device serves as an emulated keyboard.



**Note:** Do not power the reader exclusively over USB. Any load to the system might cause it to reboot.

# Specifications

The following sections list general specifications for the reader.

## DataMan 290 Series Reader

Specification	DataMan 290
Weight	DataMan 290 with: <ul style="list-style-type: none"><li>• Multi-Purpose Integrated Light 6.2 mm Model: 214 g</li><li>• Multi-Purpose Integrated Light 16 mm Model: 234 g</li><li>• Mini Light 6.2 mm Model: 169 g</li><li>• Mini Light 16 mm Model: 194 g</li></ul>
Power	External LPS or NEC Class 2 power supply power supply: 24 V DC +/- 10%
Power Consumption	Average: $\leq 7.5W$ Maximum: 1.6 A
Sensor Temperature	0 – 70°C (32 – 158°F)  <b>Note:</b> Use the temperature readout in the DataMan WebUI to verify sensor temperature. If the sensor temperature exceeds 70°C, you must implement additional cooling measures. For example, mount the reader to a heat sink, or reduce ambient temperature.
Operating Temperature	0 - 40°C (32 – 104°F)

Specification	DataMan 290
Storage Temperature	-20°C – 80°C
Humidity	< 95% non-condensing
Environmental	Altitude: 2000 m, indoor use only, pollution degree II
Shock (Shipping and Storage)	IEC 60068-2-27: 1000 shocks, semi-sinusoidal, 11 g, 10 ms ISTA-1A Standardized Testing - Packaged Products 150 lb or less
Vibration (Shipping and Storage)	IEC 60068-2-6: vibration test in each of the three main axis for 2 hours @ 10 Gs (10 to 500 Hz at 100m/s <sup>2</sup> / 15 mm) FedEx Vibration Testing for packaged products 150 lbs or less
RS-232	RxD, TxD according to TIA/EIA-232-F
USB	USB 2.0, Device Configuration Mode
Codes	<b>1-D barcodes:</b> Codabar, Code 39, Code 128, Code 93, Code 25, Interleaved 2 of 5, Postal Codes, UPC/EAN/JAN, MSI <b>2-D barcodes:</b> Data Matrix (IDMax and IDQuick: ECC 0, 50, 80, 100, 140, and 200), QR Code, microQR, PDF 417, AztecCode, DotCode, MaxiCode
High-Speed	I <sub>MAX</sub> : 50 mA
Outputs	V <sub>OL</sub> : ≤ ± 3 V @ 50 mA
Trigger	V <sub>IL</sub> : ≤ ± 6 V



Specification	DataMan 290
Inputs	$V_{IH}: \geq \pm 12 \text{ V}$
	$I_{TYP}: 4.2 \text{ mA @ } 24 \text{ V}$
Ethernet	10/100 BASE-T. Full duplex or half duplex. IEEE802.3

## DataMan 290 Series Reader Image Sensor

Specification	Values
Image Sensor	1/3-inch CMOS, global shutter
Image Sensor Properties	Diagonal size: 6.21 mm Pixel size: 3.45 $\mu\text{m}$ (H)
Image Resolution (pixels)	1440 $\times$ 1080 (1.6 mp)
Electronic Shutter Speed	Minimum exposure: 43 $\mu\text{s}$ Maximum exposure: 200 ms (with external illumination)
Image Acquisition at Full Resolution	Maximum: 45 Hz
Lens Type	<ul style="list-style-type: none"><li>• 6.2 mm (3 pos or LLM) with IR blocking filter</li><li>• 16 mm (manual or LLM) with IR blocking filter</li></ul>

# LED Wavelengths

The following table shows LED types and the related peak wavelengths.

Illumination	Illustration	LED	Color Temperature / $\lambda$ [nm]
Multi-Purpose Integrated Light		Red	620 $\lambda$ (nm)
		White	4000 K (Color Temperature)
Mini Light		Red	617 $\lambda$ (nm)

# Regulations and Conformity



**Note:** For the most current CE and UKCA declaration and regulatory conformity information, see the Cognex support site: [cognex.com/support](http://cognex.com/support).

The DataMan 290 reader has the Regulatory Model 50141 and meets or exceeds the requirements of all applicable standards organizations for safe operation. However, as with any electrical equipment, the best way to ensure safe operation is to operate them according to the agency guidelines that follow. Please read these guidelines carefully before using your reader.

Safety and Regulatory	
Manufacturer	Cognex Corporation One Vision Drive Natick, MA 01760 USA
	DataMan 290: Regulatory Model 50141 This is a class A product. In a domestic environment this product may cause radio interference in which case the user may be required to take immediate measures. This equipment complies with the essential requirements of the EU Directive 2014/30/EU. Declarations are available from your local representative.
EU RoHS	Compliant to the most recent applicable directive.
FCC	FCC Part 15, Class A This equipment has been tested and found to comply with the limits for a Class A digital device, pursuant to part 15 of the FCC Rules. These limits are designed to provide reasonable protection against harmful interference when the equipment is operated in a commercial environment. This equipment generates, uses, and can radiate radio frequency energy and, if not installed and used in accordance with the instruction manual, may cause harmful interference to radio communications. Operation of this equipment in a residential area is likely to cause harmful interference in which case the user will be required to correct the interference at his own expense.

### Safety and Regulatory

<p>Korea</p> 	<p>DataMan 290: Regulatory Model R-R-CGX-50141          This device is certified for office use only and if used at home, there can be frequency interference problems.</p>
<p>UL, TÜV SÜD</p>	<p>DataMan 290: Regulatory Model 50141</p> <p>NRTL: NRTL OSHA Scheme for UL/CAN 61010-1, UL E-File Number: E541651</p> <p>CB report available upon request. IEC/EN 61010-1.</p>
<p>UK CA</p>	<p>Regulator Model 50141          This is a class A product. In a domestic environment this product may cause radio interference in which case the user may be required to take immediate measures. This equipment complies with the essential requirements of the Electromagnetic Compatibility Regulations 2016. Declarations are available from your local representative.</p>

# 中国大陆RoHS (Information for China RoHS Compliance)

根据中国大陆《电子信息产品污染控制管理办法》(也称为中国大陆RoHS), 以下部份列出了本产品中可能包含的有毒有害物质或元素的名称和含量。



	Hazardous Substances 有害物质					
Part Name 部件名称	Lead (Pb) 铅	Mercury (Hg) 汞	Cadmium (Cd) 镉	Hexavalent Chromium (Cr (VI)) 六价铬	Polybrominated biphenyls (PBB) 多溴联苯	Polybrominated diphenyl ethers (PBDE) 多溴二苯醚
Regulatory Model 50141	X	O	O	O	O	O
<p>This table is prepared in accordance with the provisions of SJ/T 11364.                      这个标签是根据SJ/T 11364 的规定准备的。</p> <p>O: Indicates that said hazardous substance contained in all of the homogeneous materials for this part is below the limit requirement of GB / T26572 - 2011.                      表示本部件所有均质材料中含有的有害物质低于GB / T26572 - 2011 的限量要求。</p> <p>X: Indicates that said hazardous substance contained in at least one of the homogeneous materials used for this part is above the limit requirement of GB / T26572 - 2011.                      表示用于本部件的至少一种均质材料中所含的有害物质超过GB / T26572 - 2011 的限制要求。</p>						

## For European Community Users

Cognex complies with Directive 2012/19/EU OF THE EUROPEAN PARLIAMENT AND OF THE COUNCIL of 4 July 2012 on waste electrical and electronic equipment (WEEE).

This product has required the extraction and use of natural resources for its production. It may contain hazardous substances that could impact health and the environment, if not properly disposed.

In order to avoid the dissemination of those substances in our environment and to diminish the pressure on the natural resources, we encourage you to use the appropriate take-back systems for product disposal. Those systems will reuse or recycle most of the materials of the product you are disposing in a sound way.



The crossed out wheeled bin symbol informs you that the product should not be disposed of along with municipal waste and invites you to use the appropriate separate take-back systems for product disposal.

If you need more information on the collection, reuse, and recycling systems, please contact your local or regional waste administration.

You may also contact your supplier for more information on the environmental performance of this product.

Copyright © 2024  
Cognex Corporation. All Rights Reserved.