

## DataMan<sup>®</sup> 280 EtherCat Series Quick Reference Guide

2025 September 22  
Revision: 25.3.2.1



# Precautions

To reduce the risk of injury or equipment damage, observe the following precautions when you install the Cognex product:

- The safety of any system incorporating this product is the responsibility of the assembler of the system.
- Do not install Cognex products where they are exposed to environmental hazards such as excessive heat, dust, moisture, humidity, impact, vibration, corrosive substances, flammable substances, or static electricity.
- Route cables and wires away from high-current wiring or high-voltage power sources to reduce the risk of damage or malfunction from the following causes: over-voltage, line noise, electrostatic discharge (ESD), power surges, or other irregularities in the power supply.
- Do not expose the image sensor to laser light. Image sensors can be damaged by direct, or reflected, laser light. If your application requires laser light that might strike the image sensor, use a lens filter at the corresponding laser wavelength. For suggestions, contact your local integrator or application engineer.
- This product does not contain user-serviceable parts. Do not make electrical or mechanical modifications to product components. Unauthorized modifications can void your warranty.
- Changes or modifications not expressly approved by the party responsible for regulatory compliance could void the user's authority to operate the equipment.
- Include service loops with cable connections.

- Ensure that the cable bend radius begins at least six inches from the connector. Cable shielding can be degraded or cables can be damaged or wear out faster if a service loop or bend radius is tighter than 10X the cable diameter.
- This device should be used in accordance with the instructions in this manual.
- All specifications are for reference purposes only and can change without notice.

# Symbols

The following symbols indicate safety precautions and supplemental information:



**WARNING:** This symbol indicates a hazard that could cause death, serious personal injury or electrical shock.

---



**CAUTION:** This symbol indicates a hazard that could result in property damage.

---



**Note:** This symbol indicates additional information about a subject.

---





**Tip:** This symbol indicates suggestions and shortcuts that might not otherwise be apparent.



---

# Accessories

You can purchase the following components separately. For a list of options and accessories, contact your local Cognex sales representative.

## Lenses



| Accessory  | Product Number | Illustration  | DM280<br>EC |
|--|----------------|---|-------------|
| 6.2 mm lens kit that includes: <ul style="list-style-type: none"><li>• 6.2 mm optics mount</li><li>• 6.2 mm lens</li><li>• Manual lens cap (assembled)</li><li>• Screws</li></ul>  | DM280-LENS-62  |  | ✓           |
| UV Light Kit for 6.2 mm lens (Risk Group Exempt acc. IEC 62471) <ul style="list-style-type: none"><li>• UV light board (365 nm wavelength)</li><li>• UV resistant front cover</li><li>• Screws</li></ul>   | DM280-UV365-62 |  | ✓           |
| 16 mm lens kit with extended optics mount (requires the use of an extended front cover and high-powered red LED). The kit includes: <ul style="list-style-type: none"><li>• 16 mm optics mount</li><li>• 16 mm lens</li><li>• Manual lens cap (assembled)</li><li>• Screws</li></ul> | DM260-LENS-16  |  | ✓           |

| Accessory  | Product Number  | Illustration  | DM280<br>EC |
|--|-----------------|---|-------------|
| IR 6.2 mm lens kit, 3-position with IR LED includes: <ul style="list-style-type: none"> <li>• 6.2 mm optics mount</li> <li>• 6.2 mm lens (IR)</li> <li>• Standard Infrared Light for 6.2mm (Risk Group Exempt acc. IEC62471)</li> <li>• Manual lens cap (not assembled)</li> <li>• Screws</li> </ul> | DM280-KIT-IR-62 |  | ✓           |
| IR 16 mm lens kit that includes: <ul style="list-style-type: none"> <li>• 16 mm optics mount</li> <li>• 16 mm lens (IR)</li> <li>• Standard Infrared Light for 16mm (Risk Group Exempt acc. IEC62471)</li> <li>• Manual lens cap (assembled)</li> <li>• Screws</li> </ul>                            | DMA-KIT-IR-16   |  | ✓           |
| High Speed Liquid Lens Module (HSLM) to be used with 6.2 mm lens or 16 mm lens   | DMA-HSLM-280    |  | ✓           |



| Accessory   | Product Number   | Illustration  | DM280<br>EC |
|---|------------------|---|-------------|
| 16 mm lens with ImageMax kit that includes: <ul style="list-style-type: none"> <li>• 16 mm optics mount</li> <li>• 16 mm lens</li> <li>• High Speed Liquid Lens Module (DMA-HSL-280)</li> <li>• High Powered red LED illumination (DM260-LED-RED-HP) (Risk Group Exempt acc. IEC62471)</li> <li>• 2-LED half-polarized extended cover (DM260-LENS-16CVR-P) (Risk Group Exempt acc. IEC62471)</li> </ul> | DM280-KIT-IMGMAX |  | ✓           |



## Illumination

| Accessory  | Product Number | Illustration  | DM280<br>EC |
|--|----------------|---|-------------|
| Red LED Light for 6.2 mm Lens (Risk Group Exempt acc. IEC 62471)   | DM150-LED-RED  |  | ✓           |
| White LED Light for 6.2 mm Lens (Risk Group Exempt acc. IEC 62471) | DM150-LED-WHT  |   | ✓           |
| Blue LED Light for 6.2 mm Lens (Risk Group Exempt acc. IEC 62471)  | DM150-LED-BLU  |   | ✓           |

| Accessory   | Product Number   | Illustration  | DM280 EC |
|---|------------------|---|----------|
| High-Powered Red LED Light for 16 mm Lens (Risk Group Exempt acc. IEC 62471) For maximum light power 24 V DC supply is recommended. | DM280-LED-RED-HP |  | ✓        |
| High-Powered White LED Light for 16 mm Lens (Risk Group Exempt acc. IEC 62471)  | DM280-LED-WHT-HP |  | ✓        |







## Lens Covers







| Accessory   | Product Number     | Illustration  | DM280 EC |
|---|--------------------|---|----------|
| Standard front cover. Use with a 6.2 mm lens only.                  | DM280-CVR-62       |  | ✓        |
| Standard front cover, half-polarized. Use with a 6.2 mm lens only.  | DM280-LENS-62CVR-P |  | ✓        |
| Standard front cover, fully-polarized. Use with a 6.2 mm lens only. | DM280-LENS-62CVR-F |  | ✓        |

| Accessory  | Product Number         | Illustration  | DM280<br>EC |
|--|------------------------|---|-------------|
| Extended front cover.<br>Use with a 16 mm lens<br>only.                  | DM260-LENS-<br>16CVR   |  | ✓           |
| Extended front cover,<br>half-polarized. Use with a<br>16 mm lens only.  | DM260-LENS-<br>16CVR-P |   | ✓           |
| Extended front cover,<br>fully-polarized. Use with a<br>16 mm lens only. | DM260-LENS-<br>16CVR-F |   | ✓           |
| C-mount adapter, IP40  | DM280-CMNT-00          |  | ✓           |
| C-mount cover, IP65  | DM280-CMNT-CVR         |  | ✓           |





## Cables

**i Note:** Cables are sold separately.

| Accessory   | Product Number   | Illustration  | DM280<br>EC |
|---|--|---|-------------|
| Ethernet Cable, X-coded M12-8 to RJ-45              | CCB-84901-2001-xx (straight, xx specifies length: 2m, 5m, 10m, 15m, 30m) |  | ✓           |
| Ethernet Cable, X-coded M12-8 to RJ-45              | CCB-84901-2002-xx (right-angled, xx specifies length: 2m, 5m, 10m)       |  | ✓           |
| Ethernet Cable, Robotic X-Coded M12-8 to RJ-45      | CCB-84901-2RBT-xx (straight, xx specifies length: 2m, 5m, 10m)           |  | ✓           |
| X-Coded to A-Coded Ethernet cable adapter, 0.5 m    | CCB-M12X8MS-XCAC   |  | ✓           |
| Power and I/O Breakout Cable, M12-12 to Flying Lead | CCB-M12x12Fy-05 (y = straight/angled, xx specifies length)               |  | ✓           |
| Power and I/O Breakout Cable, M12-12 to Flying Lead | CCBL-05-01   |  | ✓           |
| Power and I/O Breakout Cable, M12-12 to Flying Lead | CCB-PWRIO- xx (straight, xx specifies length: 5m, 10m, 15m)              |  | ✓           |

| Accessory   | Product Number   | Illustration  | DM280<br>EC |
|---|--|---|-------------|
| Power and I/O Breakout Cable,<br>M12-12 to Flying Lead    | CCB-PWRIO-xxR (right-angled, xx specifies<br>length: 5m, 10m, 15m) |  | ✓           |
| I/O Module Cable  | CCB-PWRIO-MOD-xx (xx specifies length:<br>2m, 5m)                  |  | ✓           |
| RS-232 Connection Cable                                   | CCB-M12xDB9Y-05  |  | ✓           |
| I/O Extension Cable                                       | CKR-200-CBL-EXT  |  | ✓           |
| Sealed USB Type C Cable to USB<br>Type A, Straight, 2.5 m | DMA-STCBLE-IP65-25   |  | ✓           |
| Sealed USB Type C Cable to USB<br>Type A, Straight 3.6 m  | DMA-STCBLE-IP65-36   |   | ✓           |
| Sealed USB Type C Cable to USB<br>Type A, Angled, 2.5 m   | DMA-RTCBLE-IP65-25   |  | ✓           |
| Sealed USB Type C Cable to USB<br>Type A, Angled, 3.6 m   | DMA-RTCBLE-IP65-36   |   | ✓           |
| EtherCAT Adapter Cable                                    | CCB-ECAT-30  |  | ✓           |

# Mounting Brackets

| Accessory                                | Product Number  | Illustration  | DM280 EC |
|--|-----------------|---|----------|
| Universal mounting bracket               | DM100-UBRK-000  |  | ✓        |
| Pivot mounting bracket                   | DM100-PIVOTM-01 |  | ✓        |
| Tilted angle pivot bracket               | DMBK-DMPIVOT-00 |  | ✓        |
| Logistics mounting bracket and plate kit | DMA-BKT-LGS     |  | ✓        |
| Adjustable mirror bracket                | DMA-262-MIR     |  | ✓        |

# DataMan 280 EtherCAT Systems

|  | Omnidirectional 1D Codes | 1D Max with Hotbars | High Speed Decoding | 2DMax - Hard to Read 2D Codes | PowerGrid - Damaged 2D Codes | Multi-Reader Sync | Resolution  |
|--|--------------------------|---------------------|---------------------|-------------------------------|------------------------------|-------------------|-------------|
| DM-280L 1D Codes   |                          | ✓                   | ✓                   |                               |                              | ✓                 | 1440 x 1080 |
| DM-280QL 1D Codes  | ✓                        | ✓                   | ✓                   |                               |                              | ✓                 |             |
| DM-280S 1D/2D Codes  | ✓                        | ✓                   |                     |                               |                              | ✓                 |             |
| DM-280Q 1D/2D Codes  | ✓                        | ✓                   | ✓                   | ✓                             |                              | ✓                 |             |
| DM-280X 1D/2D Codes  | ✓                        | ✓                   | ✓                   | ✓                             | ✓                            | ✓                 |             |

# Setting Up Your DataMan 280 Reader

Read this section to learn how the reader connects to its standard components and accessories.

---

**Note:**

- Cables are sold separately.
- If a standard component is missing or damaged, immediately contact your Cognex Authorized Service Provider (ASP) or Cognex Technical Support.



**CAUTION:** All cable connectors are keyed to fit the connectors on the reader. Do not force the connections or damage may occur.

---

# Reader Layout

## DM280 EtherCAT Layout

The image and table below shows the elements of the reader.

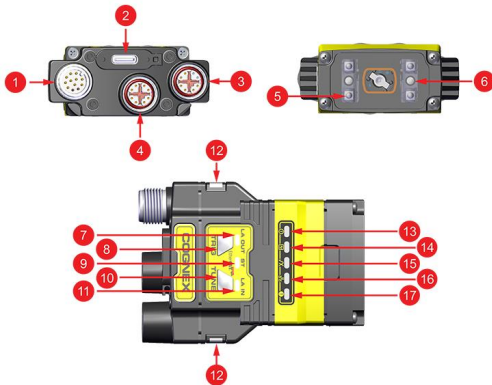

| Number | Description                        |
|--------|------------------------------------|
| 1      | Power I/O Breakout cable connector |
| 2      | USB-C slot (with plastic cover)    |
| 3      | Network connector (EtherCAT)       |
| 4      | Ethernet connector                 |
| 5      | Illumination LEDs                  |

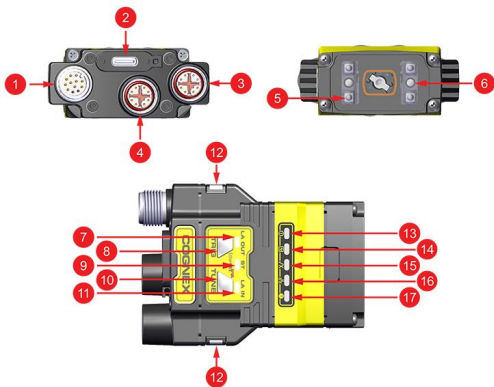

| Number | Description                                 |
|--------|---|
| 6      | LED aimers                                  |
| 7      | EtherCAT Link Activity Out LED <sup>1</sup> |
| 8      | Trigger button                              |
| 9      | EtherCAT Status LED <sup>1</sup>            |
| 10     | Tune button                                 |
| 11     | EtherCAT Link Activity In LED <sup>1</sup>  |
| 12     | Indicator LEDs                              |

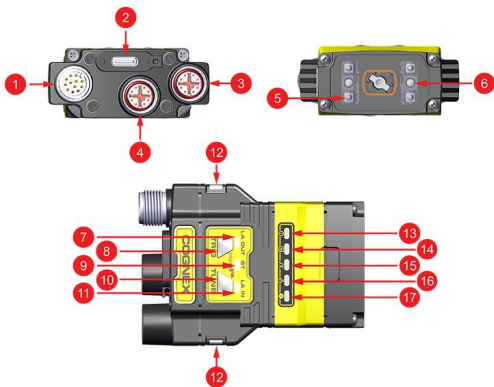

| Number | Description                        |
|--------|------------------------------------|
| 13     | Power LED indicator                |
| 14     | Train/Trigger status LED indicator |
| 15     | Good/Bad read LED indicator        |
| 16     | Communication LED indicator        |
| 17     | Error LED indicator                |

<sup>1</sup>For more information on the EtherCAT LEDs, see *EtherCAT Indicators* on page 19.

## EtherCAT Indicators

The following table summarizes the functions of the EtherCAT-specific indicator LEDs.

| Indicator | Color/Status   | Meaning  |
|-----------|----------------|--|
| LA IN     | ON             | The Link Activity LED is ON when there is an EtherCAT connection.  |
|           | ON, flickering | The Link Activity LED flickers when data is going back and forth.  |
|           | OFF            | The Link Activity LED is OFF when there is no EtherCAT connection. |

|        |              |  |  |
|--------|--------------|--|--|
| ST     | GREEN        | ON   | The Status LED is steady GREEN when the EtherCAT connection is running.                            |
|        |              | blinking   | The Status LED blinks GREEN when the EtherCAT connection is in PRE-OPERATIONAL state.              |
|        |              | single flash   | The Status LED flashes once GREEN when the EtherCAT connection is in SAFE-OPERATIONALstate.        |
|        |              | OFF  | The GREEN, blinking Status LED is OFF when the EtherCAT connection is in INIT state.               |
|        | RED          | ON   | The Status LED is RED when a critical communication or application controller occurs.              |
|        |              | double flash   | The Status LED is RED when an EtherCAT Watchdog Timeout error occurs.                              |
|        |              | single flash   | The Status LED is RED when a local error occurs.   |
|        |              | blinking   | The Status LED is RED when a general configuration error occurs.                                   |
|        |              | OFF  | The Status LED is RED when there is no error, the EtherCAT communication of the device is running. |
| LA OUT | ON           | The Link Activity LED is ON when there is an EtherCAT connection.  |  |
|        | ON, blinking | The Link Activity LED blinks when data is going back and forth.    |  |
|        | OFF          | The Link Activity LED is OFF when there is no EtherCAT connection. |  |

# Dimensions

The following sections list dimensions of the reader.

**Note:**



- Dimensions are in millimeters and are for reference purposes only.
- All specifications are for reference purposes only and can change without notice.

## DataMan 280 EtherCAT with 6.2 mm lens

The following image shows the dimensions of DataMan 280 EtherCat, equipped with 6.2 mm lens.

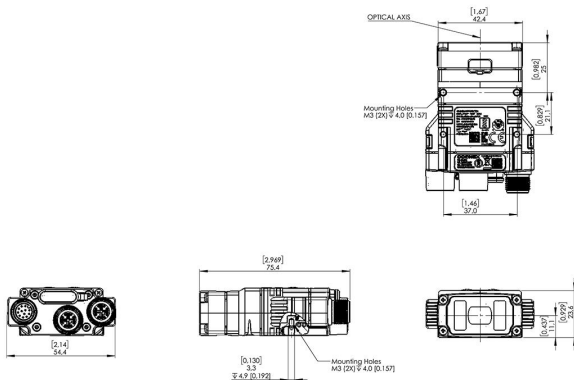

## DataMan 280 EtherCAT with 16 mm Lens

The following image shows the dimensions of DataMan 280 EtherCAT equipped with 16 mm lens.

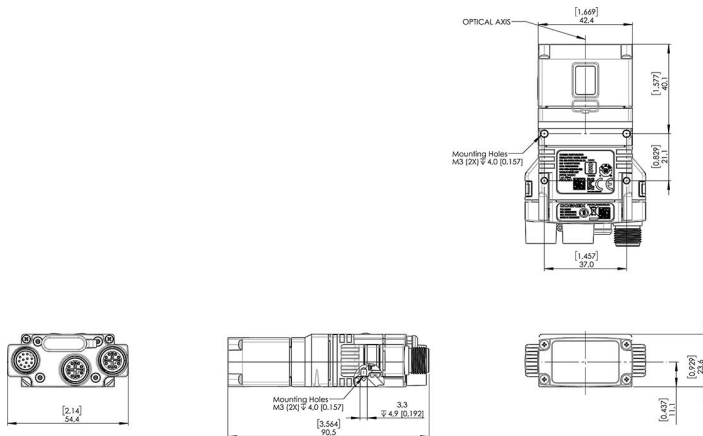



## DataMan 280 EtherCAT with L-shaped extension, equipped with 16 mm Lens

The following image shows the dimensions of DataMan 280 EtherCAT equipped with L-shaped extension and 16 mm lens.

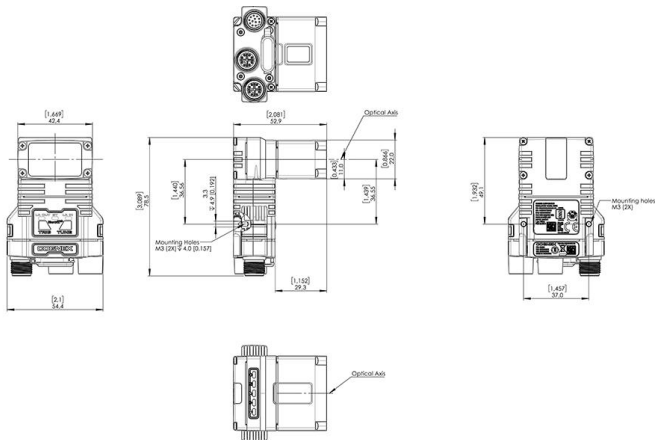

## DataMan280 EtherCAT with Side Mirror Accessory

The following image shows the dimensions of DataMan280 EtherCAT equipped with the side mirror accessory

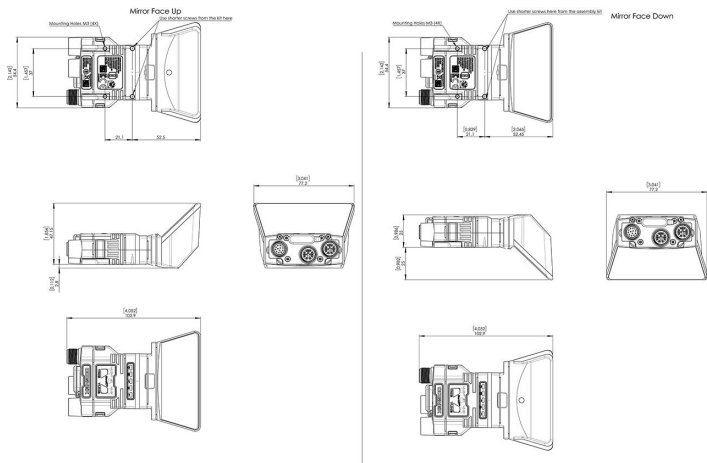

## Field of View and Reading Distance

This section provides the Field of View (FoV) values for 6.2 mm and 16 mm lenses.

### DataMan 280 EC Readers with 6.2 mm Lens

6.2 mm lenses can be focused to 105 mm (short range) and to 190 mm (long range).

#### Short Range (Focused to 105 mm)

The following tables show the Field of View (FoV) widths of the 6.2 mm lens focused to 105 mm at various distances.

| Working distance in mm | Horizontal values in mm | Vertical values in mm |
|------------------------|-------------------------|-----------------------|
| $Z_1 = 40$             | $X_1 = 38$              | $Y_1 = 29$            |
| $Z_2 = 65$             | $X_2 = 58$              | $Y_2 = 44$            |
| $Z_3 = 105$            | $X_3 = 90$              | $Y_3 = 68$            |

| Distances in mm | 2D min. code in mil | 1D min. code in mil |
|-----------------|---------------------|---------------------|
| 40              | 4                   | 2                   |
| 65              | 5                   | 3                   |
| 105             | 10                  | 5                   |

#### Long Range (Focused to 190 mm)

The following table shows the Field of View (FoV) widths of the 6.2 mm lens focused to 190 mm at various distances.

| Working distance in mm | Horizontal values in mm | Vertical values in mm |
|------------------------|-------------------------|-----------------------|
| $Z_1 = 190$            | $X_1 = 159$             | $Y_1 = 119$           |
| $Z_2 = 225$            | $X_2 = 187$             | $Y_2 = 140$           |
| $Z_3 = 375$            | $X_3 = 307$             | $Y_3 = 230$           |
| $Z_4 = 1000$           | $X_4 = 808$             | $Y_4 = 606$           |

| Distances in mm | 2D min. code in mil | 1D min. code in mil |
|-----------------|---------------------|---------------------|
| 150             | 10                  | 6                   |
| 190             | 12                  | 8                   |
| 225             | 15                  | 8                   |
| 375             | 20                  | 15                  |
| 500             | 30                  | 20                  |
| 1000            | 60                  | 35                  |

## DataMan 280 EC Readers with 16 mm lens

The following tables list the Field of View (FoV) widths of the 16 mm lens at various distances:

| Working distance in mm | Horizontal values in mm | Vertical values in mm |
|------------------------|-------------------------|-----------------------|
| $Z_1 = 150$            | $X_1 = 46$              | $Y_1 = 34$            |
| $Z_2 = 225$            | $X_2 = 69$              | $Y_2 = 52$            |

| Working distance in mm | Horizontal values in mm | Vertical values in mm |
|------------------------|-------------------------|-----------------------|
| $Z_3 = 375$            | $X_3 = 116$             | $Y_3 = 87$            |
| $Z_4 = 1000$           | $X_4 = 310$             | $Y_4 = 232$           |

| Distances in mm | 2D min. code in mil | 1D min. code in mil |
|-----------------|---------------------|---------------------|
| 80              | 2                   | 2                   |
| 150             | 3                   | 2                   |
| 190             | 4                   | 3                   |
| 225             | 5                   | 3                   |
| 375             | 8                   | 5                   |
| 500             | 10                  | 7                   |
| 1000            | 20                  | 15                  |

## Mounting the Reader

The reader provides mounting holes for attachment to a mounting surface.

**CAUTION:** The reader has to be grounded, either by mounting the reader to a fixture that is electrically grounded or by attaching a wire from the mounting fixture of the reader to frame ground or Earth ground. If a ground wire is used, it has to be attached to one of the four mounting points on the bottom plate of the reader and not to the mounting points on the front of the reader.

The method of mounting depends on whether the reader is in straight or right-angle configuration, regardless of the product variant.

### Mounting the Reader in Straight Configuration

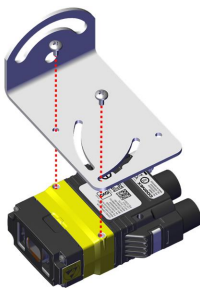

Align the holes on the mounting surface with the mounting holes on the reader.  
Insert the M3 screws into the mounting holes.

## Mounting the Reader in Right-Angle Configuration



Align the holes on the mounting surface with the mounting holes on the reader. With the reader in right-angle position, only the back mounting holes can be used.

**Note:**

Mounting the reader at a slight angle ( $15^\circ$ ) reduces reflections and improves performance.

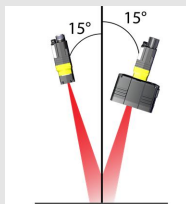

## Connecting the Ethernet Cable

---



**CAUTION:** The Ethernet cable shield has to be grounded at the far end. If the far end device is not grounded, add a ground wire in compliance with local electrical codes. The cable is typically plugged into a switch or router, which has to have a grounded Ethernet connector. Use a digital voltmeter to validate the grounding.

---

1. Connect the M12 connector of the Ethernet cable to the reader ENET connector.
2. Connect the RJ-45 connector of the Ethernet cable to a switch/router or PC, as applicable.

### Note:



Besides powering the DataMan 280 readers through a Breakout Cable, it is possible to power DataMan through PoE connection as well, in which case it is not necessary to use a Breakout Cable.

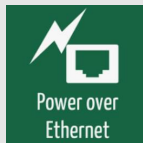

## Connecting the EtherCAT Cable to the DataMan 280 EtherCAT Reader

Connect the EtherCAT cable to the EtherCAT connector of the DataMan 280 EtherCAT Reader:



**Note:** Do not plug the EtherCAT cable into an Ethernet network. You could damage your Ethernet network and disable your EtherCAT set.

The DataMan 280 EtherCAT reader provides two 100 MBit EtherCAT ports in a single physical connector. One of the ports acts as input, and the other one as output:

- If you connect an M12 to RJ-45 Ethernet cable to the EtherCAT connector, you connect to the IN port.
- If you connect with the EtherCAT adapter cable, both the IN and OUT ports are available



The DataMan 280 EtherCAT supports the following physical topologies:

- Star
- Line
- Ring

**i Note:** For detailed information on the supported EtherCAT configurations, see the *DataMan Industrial Protocols Manual*.

## Star EtherCAT Topology

The star topology connects each reader to the PLC individually. This topology offers increased availability, as each reader can be reached individually.

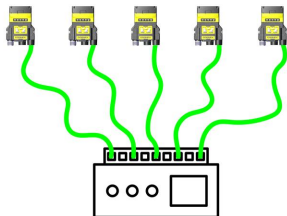

## Line EtherCAT Topology

The line topology connects the readers in daisy chain. The output of one adapter cable is plugged into the input of the next one. The line starts at the output from the PLC, and ends at the input connector of the last reader. This topology reduces the cabling needed to connect all readers.

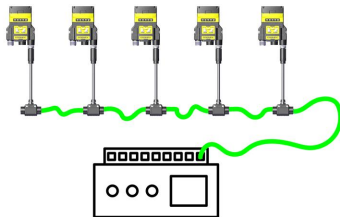

## Ring EtherCAT Topology

The ring topology connects the readers in daisy chain. The output of one adapter cable is plugged into the input of the next one. The ring starts at the output from the PLC, and ends at the output of the last reader connected back to the PLC. This topology offers redundancy, since a reader can be reached from either direction.

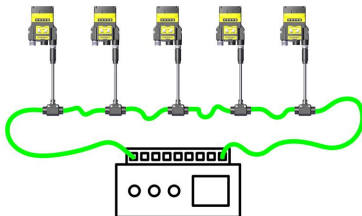

## Connecting the Power and I/O Breakout Cable

**CAUTION:** To reduce emissions, connect the far end of the Breakout cable shield to frame ground.

### Note:



- Perform wiring or adjustments to I/O devices when the reader is not receiving power.
- You can clip unused wires short or use a tie made of non-conductive material to tie them back. Keep bare wires separated from the +24 V DC wire.

1. Verify that the 24 V DC power supply is unplugged and not receiving power.
2. Attach the +24 V DC connector of the Power and I/O Breakout cable and Ground wires to the corresponding terminals on the power supply. For more information, see *Specifications* on page 37.



**CAUTION:** Never connect voltages other than 24 V DC. Always observe the polarity shown.

---

3. Attach the M12 connector of the Power and I/O Breakout Cable to the 24 V DC connector of the reader.
4. Restore power to the 24 V DC power supply and turn it on if necessary.

## Using your Device through USB

For a detailed description, see the DataMan 280 Reference Manual.



**Note:** To prevent issues, ensure that the USB connector is tightly screwed on.

---

# Specifications

The following sections list general specifications for the reader.

## DataMan 280 EC Reader

| Specification              | DataMan 280 EC  |
|----------------------------|---|
| Weight                     | 6.2 mm: 141 g<br>16 mm: 169 g<br>Right angle configuration adds 50 g  |
| Power                      | 24 V DC +/- 10%   |
| 24 V Supply                | 24 V DC $\pm$ 10%<br>LPS or NEC class 2<br>Power consumption without USB device attached: <ul style="list-style-type: none"><li>• Average <math>\leq</math> 5 W using High-Powered Light</li><li>• Average <math>\leq</math> 6 W using High Frequency High-Powered Light</li><li>• Peak <math>\leq</math> 1.6 A using internal illumination</li></ul> |
| Power over Ethernet Supply | N/A   |
| Operating Temperature      | 0–40°C (32–104°F)   |
| Storage Temperature        | -10–60°C (14–140°F)   |

| Specification                       | DataMan 280 EC   |
|-------------------------------------|--|
| Humidity                            | <95% non-condensing  |
| Environmental                       | IP67   |
|                                     |  <b>Note:</b> IP67 rating applies only if all blind plugs and cables are attached properly, or the provided connector plug is installed. Also, make sure that the IP67-rated cover is installed properly. |
| Shock                               | IEC 60068-2-27 - 500 shocks in each polarity of each (X, Y, and Z) axis, 3000 shocks total, semi-sinusoidal, 11 g, 10 ms   |
| Shock<br>(Shipping and Storage)     | ISTA-1A Standardized Testing - Packaged Products 150 lb or less  |
| Vibration                           | IEC 60068-2-6: vibration test in each of the three main axis for 2 hours @ 10 Gs (10 to 500 Hz at 100m/s <sup>2</sup> / 15 mm)   |
| Vibration<br>(Shipping and Storage) | FedEx Vibration Testing for packaged products 150 lbs or less  |
| Codes                               | <b>1-D barcodes:</b> Codabar, Code 39, Code 128, Code 93, Code 25, Interleaved 2 of 5, Postal Codes, UPC/EAN/JAN, MSI<br><b>2-D barcodes:</b> Data Matrix (IDMax and IDQuick: ECC 0, 50, 80, 100, 140, and 200), QR Code, microQR, PDF 417, AztecCode, DotCode, MaxiCode                   |
| EtherCAT                            | For details on the EtherCAT interface, see <i>Connecting the EtherCAT Cable to the DataMan 280 EtherCAT Reader</i> on page 32.   |

## DataMan 280 EC Reader Image Sensor

| Specification                        | DataMan 280 EC   |
|--------------------------------------|--|
| Image Sensor                         | 1/3-inch CMOS, global shutter  |
| Image Sensor Properties              | Diagonal size: 6.21 mm<br>Pixel size: 3.45 $\mu\text{m}$ (H) x 3.45 $\mu\text{m}$ (V)  |
| Image Resolution (pixels)            | 1440 x 1080 (1.6 MP)   |
| Electronic Shutter Speed             | Minimum exposure: 43 $\mu\text{s}$<br>Maximum exposure: 200 ms (with external illumination)  |
| Image Acquisition at Full Resolution | Maximum: 45 Hz   |
| Lens Type                            | <ul style="list-style-type: none"><li>• 6.2 mm (3 pos or LLM) with IR blocking filter</li><li>• 16 mm (manual or LLM) with IR blocking filter</li><li>• 6.2 mm UV, 6.2 mm</li><li>• 16 mm IR, C-Mount acc.</li></ul> |

# Regulations and Conformity

**i Note:** For the most current CE and UKCA declaration and regulatory conformity information, see the Cognex support site: [cognex.com/support](http://cognex.com/support).

DataMan 280 readers have Regulatory Model numbers 50211 and 50213 and meet or exceed the requirements of all applicable standards organizations for safe operation. However, as with any electrical equipment, the best way to ensure safe operation is to operate them according to the agency guidelines that follow. Please read these guidelines carefully before using your device.

| Safety and Regulatory |   |
|-----------------------|---|
| Manufacturer          | Cognex Corporation<br>One Vision Drive<br>Natick, MA 01760 USA  |
| CE                    | DataMan 280 EC Straight: Regulatory Model 50211<br>DataMan 280 EC L-Shaped: Regulatory Model 50213<br>This is a class A product. In a domestic environment this product may cause radio interference in which case the user may be required to take immediate measures. This equipment complies with the essential requirements of the EU Directive 2014/30/EU. Declarations are available from your local representative.  |
| EU RoHS               | Compliant to the most recent applicable directive.  |
| FCC                   | FCC Part 15, Class A<br>This equipment has been tested and found to comply with the limits for a Class A digital device, pursuant to part 15 of the FCC Rules. These limits are designed to provide reasonable protection against harmful interference when the equipment is operated in a commercial environment. This equipment generates, uses, and can radiate radio frequency energy and, if not installed and used in accordance with the instruction manual, may cause harmful interference to radio communications. Operation of this equipment in a residential area is likely to cause harmful interference in which case the user will be required to correct the interference at his own expense. |

### Safety and Regulatory

|   |  |
|---|--|
| <p>Korea</p>  | <p>This device is certified for office use only and if used at home, there can be frequency interference problems.<br/>         A급 기기(업무용 방송통신기자재): 이 기기는 업무용(A급) 전자파적합기기로서 판매자 또는 사용자는 이 점을 주의하시기 바라며, 가정외의 지역에서 사용하는 것을 목적으로 합니다.<br/>         DataMan 280 EC Straight: R-R-CGX-50211<br/>         DataMan 280 EC L-Shaped: R-R-CGX-50213</p>  |
| <p>TÜV</p>  | <p>DataMan 280 EC Straight: Regulatory Model 50211<br/>         DataMan 280 EC L-Shaped: Regulatory Model 50213</p> <hr/> <p>NRTL: TÜV SÜD SCC/NRTL OSHA Scheme for UL/CAN 61010-1.</p> <hr/> <p>CB report available upon request. TÜV SÜD, IEC/EN 61010-1.</p>  |
| <p>UK<br/>CA</p>  | <p>DataMan 280 EC Straight: Regulatory Model 50211<br/>         DataMan 280 EC L-Shaped: Regulatory Model 50213<br/>         This is a class A product. In a domestic environment this product may cause radio interference in which case the user may be required to take immediate measures. This equipment complies with the essential requirements of the Electromagnetic Compatibility Regulations 2016. Declarations are available from your local representative.</p> |

# 中国大陆RoHS (Information for China RoHS Compliance)

根据中国大陆《电子信息产品污染控制管理办法》(也称为中国大陆RoHS), 以下部份列出了本产品中可能包含的有毒有害物质或元素的名称和含量。



|   | Hazardous Substances 有害物质 |                      |                      |  |   |  |
|---|---------------------------|----------------------|----------------------|--|---|--|
| Part Name<br>部件名称   | Lead (Pb)<br>铅            | Mercury<br>(Hg)<br>汞 | Cadmium<br>(Cd)<br>镉 | Hexavalent<br>Chromium<br>(Cr (VI))<br>六价铬 | Polybrominated<br>biphenyls (PBB)<br>多溴联苯 | Polybrominated<br>diphenyl ethers<br>(PBDE)<br>多溴二苯醚 |
| Regulatory<br>Model<br>50211<br>Regulatory<br>Model<br>50213  | X                         | O                    | O                    | O  | O   | O  |
| <p>This table is prepared in accordance with the provisions of SJ/T 11364.<br/>这个标签是根据SJ/T 11364 的规定准备的。</p> <p>O: Indicates that said hazardous substance contained in all of the homogeneous materials for this part is below the limit requirement of GB / T26572 - 2011.<br/>表示本部件所有均质材料中含有的有害物质低于GB / T26572 - 2011 的限量要求。</p> <p>X: Indicates that said hazardous substance contained in at least one of the homogeneous materials used for this part is above the limit requirement of GB / T26572 - 2011.<br/>表示用于本部件的至少一种均质材料中所含的有害物质超过GB / T26572 - 2011 的限制要求。</p> |                           |                      |                      |  |   |  |

## For European Community Users

Cognex complies with Directive 2012/19/EU OF THE EUROPEAN PARLIAMENT AND OF THE COUNCIL of 4 July 2012 on waste electrical and electronic equipment (WEEE).

This product has required the extraction and use of natural resources for its production. It may contain hazardous substances that could impact health and the environment, if not properly disposed.

In order to avoid the dissemination of those substances in our environment and to diminish the pressure on the natural resources, we encourage you to use the appropriate take-back systems for product disposal. Those systems will reuse or recycle most of the materials of the product you are disposing in a sound way.



The crossed out wheeled bin symbol informs you that the product should not be disposed of along with municipal waste and invites you to use the appropriate separate take-back systems for product disposal.

If you need more information on the collection, reuse, and recycling systems, please contact your local or regional waste administration.

You may also contact your supplier for more information on the environmental performance of this product.

Copyright © 2025  
Cognex Corporation. All Rights Reserved.