

COGNEX

DataMan[®] 470 Series Quick Reference Guide

2025 July 30
Revision: 25.3.1.2



Symbols

The following symbols indicate safety precautions and supplemental information:



WARNING: This symbol indicates a hazard that could cause death, serious personal injury or electrical shock.



CAUTION: This symbol indicates a hazard that could result in property damage.



Note: This symbol indicates additional information about a subject.



Tip: This symbol indicates suggestions and shortcuts that might not otherwise be apparent.

Product Overview

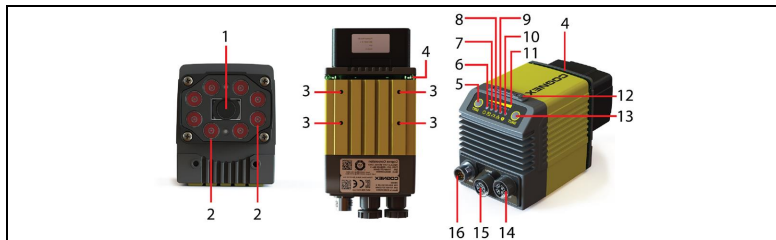



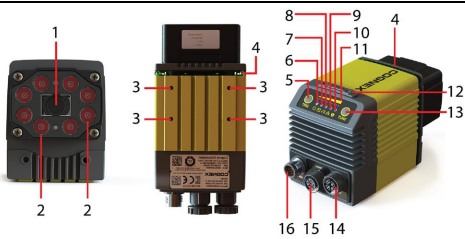



Number	Item
1	Lens
2	Illumination LED clusters
3	Mounting holes (M3 x 5mm)
4	Indicator light ring
5	Trigger button
6	Power
7	Train status
8	Read/no-read indicator
9	Network



Number	Item
10	Error
11	Peak meter
12	SD card slot
13	Tuning button
14	Ethernet
15	External light control
16	Power, I/O, and RS-232

DataMan 470 Series Accessories

LENS OPTIONS AND COVERS

Accessory			DM474	DM475
8 mm F5.6 fixed aperture lens	LEC-CFF08-F5.6			
12 mm F8 fixed aperture lens	LEC-CFF12-F8			
16 mm F8 fixed aperture lens	LEC-CFF16-F8			
25 mm F8 fixed aperture lens	LEC-CFF25-F8			
35 mm F8 fixed aperture lens	LEC-CFF35-F8			
40 mm F8 fixed aperture lens	LEC-CFF40-F8			
50 mm F8 fixed aperture lens	LEC-CFF50-F8			
Liquid lens module and pre-focused 10.3* mm or 10.3 mm IR** M12 lens with wrench	DMLN-10LL-SMT DMLN-10LL-IR-SMT			
24 mm F6 liquid lens module*	DM360-LENS-24LL			
24 mm F6 liquid lens module***	DMLN-C24F06-LL-IR			
24 mm F10 liquid lens module*	DMLN-C24F10-LL			



Accessory			DM474	DM475
8 mm F8 autofocus lens* (use with HPIL wide)	DMLN-C08F08-HSLL		✓	
10 mm F5 autofocus lens* (use with HPIT)	DMLN-C10F05-HSLL			
16 mm F8 autofocus lens* (use with HPIT)	DMLN-C16F08-HSLL		✓	✓
24 mm F6 autofocus lens* (use with HPIT)	DMLN-C24F06-HSLL			
35 mm F8 autofocus lens* (use with HPIT)	DMLN-C35F08-HSLL			

* With built-in IR blocking filter

** Without built-in IR blocking filter

*** Without built-in IR blocking filter, and with built-in daylight filter

LENS COVERS AND INTEGRATED ILLUMINATIONS





Accessory			DM474	DM475
C-Mount cover for C-Mount lenses	DM300-CMCOV		✓	✓
Short C-Mount cover for C-Mount lenses	DM300-CMCOV-SH		✓	✓

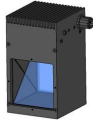

Accessory			DM474	DM475
Extension kit	DM300-EXT		✓	✓
DM500 C-Mount cover (use with HPIA)	DM500-CMTLC-000		✓	✓
DM500 Lens cover extender	DM500-LNSEXT-000		✓	✓



Accessory		DM474	DM475
Red LED HPIL, 10.3 mm lens (Risk Group Red LED Exempt acc. IEC 62471, Risk Group Green LED Aimer Exempt acc. IEC 62471)	DM360-HPIL-RE		✓
Polarized red LED HPIL, ESD safe, 10.3 mm lens (Risk Group Red LED Exempt acc. IEC 62471, Risk Group Green LED Aimer Exempt acc. IEC 62471)	DM360-HPIL-RE-P		
White LED HPIL, 10.3 mm lens (Risk Group White LED low risk acc. IEC 62471, Risk Group Green LED Aimer Exempt acc. IEC 62471)	DM360-HPIL-WHI		
Red LED HPIL, 24 mm liquid lens (Risk Group Red LED Exempt acc. IEC 62471, Risk Group Green LED Aimer Exempt acc. IEC 62471)	DMLT-HPIL-RE		
Polarized red LED HPIL, ESD safe, 24 mm liquid lens (Risk Group White LED low risk acc. IEC 62471, Risk Group Green LED Aimer Exempt acc. IEC 62471)	DMLT-HPIL-RE-P		
White LED HPIL, 24 mm liquid lens (Risk Group White LED low risk acc. IEC 62471, Risk Group Green LED Aimer Exempt acc. IEC 62471)	DMLT-HPIL-WHI		
Infrared LED HPIL, ESD safe, 10.3 & 24 mm liquid lens (Risk Group IR LED Exempt acc. IEC 62471, Risk Group Green LED Aimer Exempt acc. IEC 62471)	DMLT-HPIL-IR-W		

EXTERNAL LIGHTS AND HIGH POWER ILLUMINATIONS



Accessory		DM474	DM475
Coaxial (DOAL) light	CLRO-K5050G1		✓

Accessory			DM474	DM475
Spot light	CLRS-P14G1		✓	✓
Brick light, narrow red	IVSL-ODDM-S75-625		✓	✓
Brick light, narrow white	IVSL-ODDM-S75-WHI			
Bar light, wide red	IVSL-YLW2X-625		✓	✓
Bar light, narrow red, linear polarizer	IVSL-YLW2X-625P			
Bar light, narrow infrared	IVSL-YLW2X-850			
Bar light, narrow blue	IVSL-YLW2X-470			
Bar light, wide red	IVSL-YLW2X-625-W			
Bar light, narrow white	IVSL-YLW2X-WHI			
Bar light, wide white	IVSL-YLW2X-WHI-W			
Bar light, wide white, linear polarizer	IVSL-YLW2X-WHIP-W			
Bar light, blue	IVSL-LX520-470		✓	✓
Bar light, red	IVSL-LX520-625			
LX280-series light, blue	IVSL-LX280-470		✓	✓
Bar light, red	IVSL-LX800-625			



Accessory			DM474	DM475
Linear Polarizer Kit Case	DM30X-HPIA3-LP		✓	✓
HPIA, Red narrow	DM30X-HPIA3-625		✓	✓
HPIA, Red wide	DM30X-HPIA3-625-W			
HPIA, White narrow (Risk Group White LED low risk acc. IEC 62471)	DM30X-HPIA3-WHI			
HPIA, White wide (Risk Group White LED low risk acc. IEC 62471)	DM30X-HPIA3-WHI-W			
HPIA, Blue narrow (Risk Group White LED low risk acc. IEC 62471)	DM30X-HPIA3-470			
HPIA, Blue wide (Risk Group White LED low risk acc. IEC 62471)	DM30X-HPIA3-470-W			
HPIA, Infrared narrow (Risk Group White LED low risk acc. IEC 62471)	DM30X-HPIA3-IR			
HPIA, Infrared wide (Risk Group White LED low risk acc. IEC 62471)	DM30X-HPIA3-IR-W			









Accessory		DM474	DM475
HPIT, Red, wide, 10 and 16 mm lens (Risk Group Red LED exempt risk acc. IEC 62471)	DMLT-HPIT-RE-W		✓
HPIT, Red, standard, 24 mm lens (Risk Group Red LED exempt risk acc. IEC 62471)	DMLT-HPIT-RE-S		
HPIT, White, wide, 10 and 16 mm lens (Risk Group White LED low risk acc. IEC 62471)	DMLT-HPIT-WHI-W		
HPIT, White, standard, 24 mm lens (Risk Group White LED low risk acc. IEC 62471)	DMLT-HPIT-WHI-S		
HPIT, Red, narrow (Risk Group Red LED exempt risk acc. IEC 62471)	DMLT-HPIT-RE-N		
HPIT, White, narrow (Risk Group White LED low risk acc. IEC 62471)	DMLT-HPIT-WHI-N		
Fully polarized front cover	DMLA-HPIT-PLCOV-F		
Partially polarized front cover	DMLA-HPIT-PLCOV		
Clear front cover	DMLA-HPIT-CLCOV		
Diffuse front cover	DMLA-HPIT-DLCOV		
Passive Dome front cover	DMLA-HPIT-DFCOV		✓
Adapter (includes PCB light port adapter)	DMLA-HPIT-ADAP470		✓



FIELD OF VIEW EXPANDERS

Accessory			DM474	DM475
Field of view expander with mount	DMA-XPAND-100		✓	
Field of view expander	DMA-XPAND-150		✓	
Field of view expander	DMA-XPAND-350		✓	✓

OTHER

Accessory			DM474	DM475
Connection cable RS-232	CCB-M12xDB9Y-05		✓	✓
Connection cable 24 V, I/O, RS-232 (y straight/angled, xx specifies length)	CCB-M12x12Fy-xx		✓	✓
Connection cable 24 V, I/O, RS-232	CCBL-05-01			
Power and I/O breakout cable, M12-12, straight, xx specifies length: 5 m, 10 m, 15 m, angled, xx specifies length: 5 m, 10 m, 15 m	CCB-PWRIO-xx CCB-PWRIO-xxR			

Accessory			DM474	DM475
Power cable for multiple bar lights (use in combination with IVSL-5PM12-5)	CCB-FOV25-MAL-012		✓	✓
X-Coded to A-Coded Ethernet cable adapter, 0.5 m	CCB-M12X8MS-XCAC		✓	✓
X-Coded to RJ45 Ethernet Cable (xx specifies length: 2, 5, 15, 30 m)	CCB-84901-2001-xx		✓	✓
External light cable (xxx specifies length)Compatible with CLRR / CLRB / CLRO / CLRS / CLRD illumination	CCB-M12x4MS-xxx		✓	✓
External light control cable for DataMan, 5 meters with flying leads	CCB-M12XFLY-05		✓	✓
Bar light cable (xxx specifies length 300, 500, 1000, 2000 mm) Compatible with IVSL lights, except IVSL-LX280	IVSL-5PM12-Jxxx		✓	✓
LX280-series light cable	IVSL-FSK-J5000		✓	✓
I/O extension cable, 5 m straight	CKR-200-CBL-EXT		✓	✓
Laser aimer (use with HPIA)	DM300-AIMER-00		✓	✓

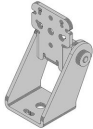
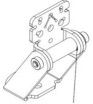
Accessory			DM474	DM475
Connection module (up to 4 cameras including network switch) (xx can be EU, UK, or JP)	DMA-CCM-4X-xx		✓	✓
Connection module (1 camera) (xx can be US, EU, UK, or JP)	DMA-CCM-1-xx		✓	✓
Mounting Bracket Kit	DMBK-470-MNT		✓	✓
Pivot Mounting Bracket (for factory automation)	DM100-PIVOTM-01		✓	✓
Pivot Mounting Bracket (for logistics)	DMBK-DMPIVOT-00		✓	✓



WARNING: For DM300-AIMER-00 and HPIT equipped with laser: This device has been tested in accordance with IEC60825-1 3rd ed., 2014., and has been certified to be under the limits of a Class 2 Laser device.

LASER LIGHT - DO NOT STARE INTO BEAM
CLASS 2 LASER PRODUCT 650nm <1mW
CLASSIFIED PER IEC 60825-1, Ed 3, 2014



Complies with FDA performance standards for laser products except for deviations pursuant to Laser Notice No. 50, dated June 24, 2007.

LASER LIGHT - DO NOT STARE INTO BEAM
CLASS 2 LASER PRODUCT 650nm <1mW
CLASSIFIED PER IEC 60825-1, Ed 3, 2014



Complies with FDA performance standards for laser products except for deviations pursuant to Laser Notice No. 50, dated June 24, 2007



Dimensions

A	Light emitting area
B	Optical axis

DataMan 474 with High Power Integrated Light (HPIL)

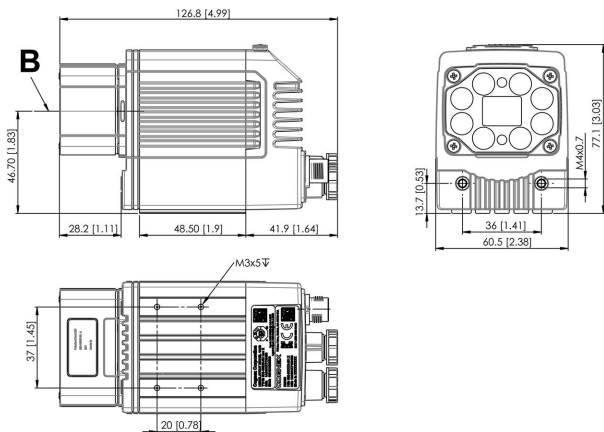

DataMan 470 Series with High power Illumination Accessory (HPIA)

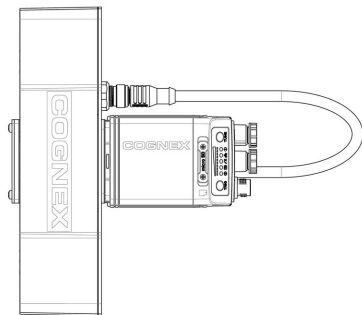
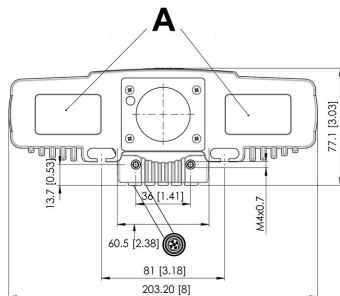
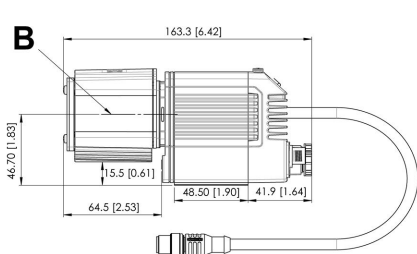

DataMan 470 Series with High Power Integrated Torch (HPIT)

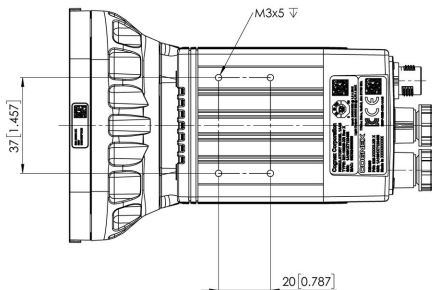
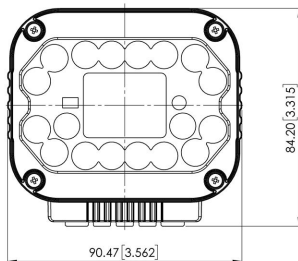
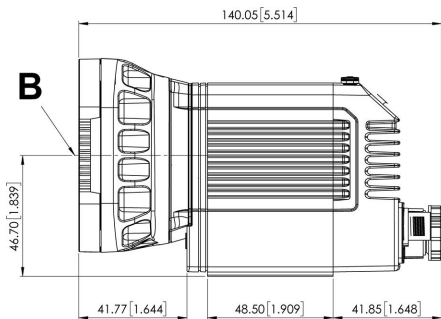

DataMan 470 Series with High Power Integrated Torch (HPIT) and Passive Diffuser

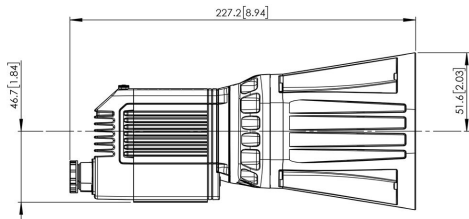
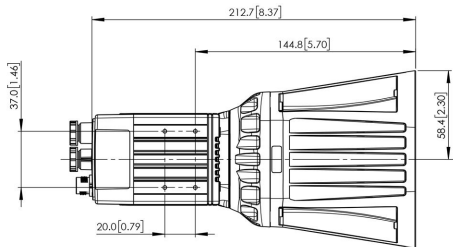
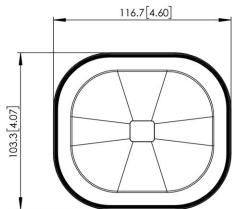

Field of View and Reading Distances

i Note: Due to tolerances, ranges can vary by +/- 5 % from unit to unit.

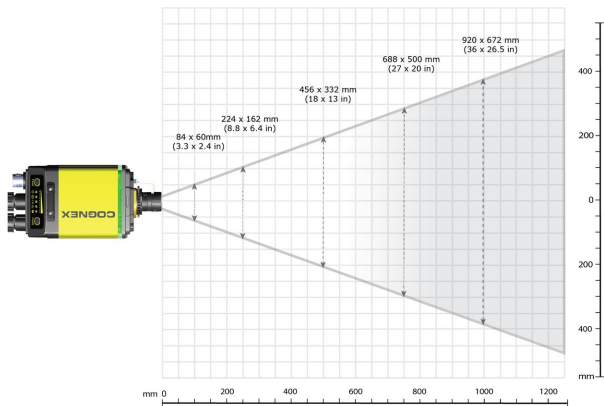

Device	Distances in mm / 1D min code 8 mm HSL		Distances in mm / 2D min code 8 mm HSL	
	DM474	235	5 MIL	140
350		7.5 MIL	210	7.5 MIL
470		10 MIL	280	10 MIL
930		20 MIL	560	20 MIL

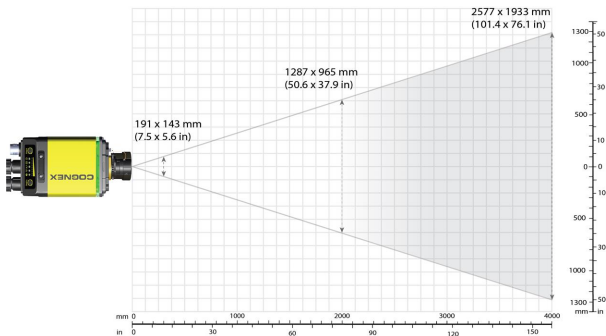

Device	Distances in mm / 1D min code 10 mm HSSL		Distances in mm / 2D min code 10 mm HSSL	
	DM474	445	6 MIL	307
591		8 MIL	408	8 MIL
738		10 MIL	509	10 MIL
958		13 MIL	660	13 MIL
1104		15 MIL	761	15 MIL
1471		20 MIL	1013	20 MIL

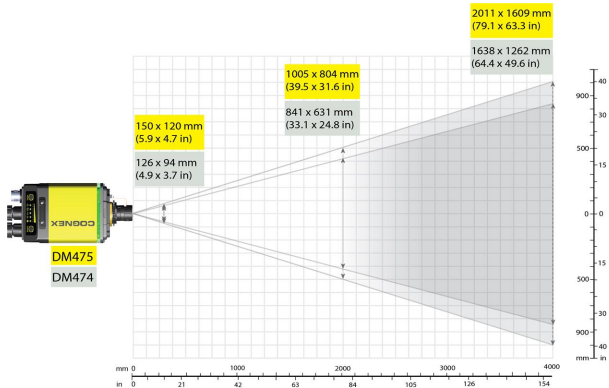

Device	Distances in mm / 1D min code 16 mm HSSL		Distances in mm / 2D min code 16 mm HSSL	
	mm	MIL	mm	MIL
DM47x	676	6 MIL	465	6 MIL
	901	8 MIL	620	8 MIL
	1125	10 MIL	774	10 MIL
	1462	13 MIL	1006	13 MIL
	1687	15 MIL	1160	15 MIL
	2249	20 MIL	1547	20 MIL

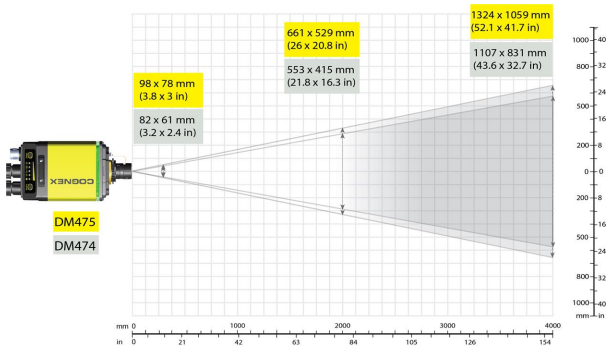

Device	Distances in mm / 1D min code 24 mm HSL		Distances in mm / 2D min code 24 mm HSL	
	DM47x	1029	6 MIL	709
1370		8 MIL	944	8 MIL
1711		10 MIL	1178	10 MIL
2223		13 MIL	1530	13 MIL
2564		15 MIL	1764	15 MIL
3417		20 MIL	2351	20 MIL

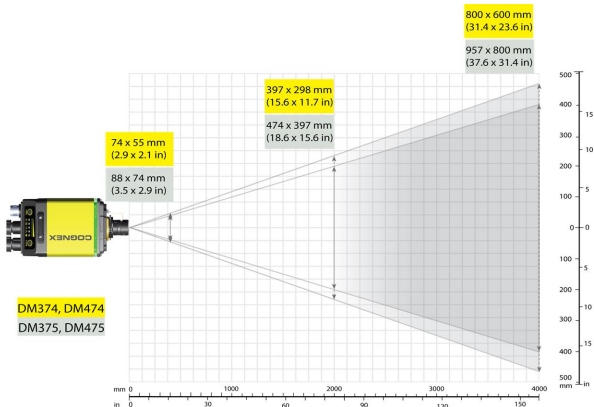

Device	Distances in mm / 1D min code 35 mm HSL		Distances in mm / 2D min code 35 mm HSL	
	DM47x	1300	6 MIL	835
1750		8 MIL	1110	8 MIL
2170		10 MIL	1390	10 MIL
2820		13 MIL	1800	13 MIL
3250		15 MIL	2080	15 MIL
4335		20 MIL	2770	20 MIL

Connecting the Reader

CAUTION: Make sure that the Ethernet cable is grounded at the far end.

Whatever this cable is plugged into (usually a switch or router) should have a grounded Ethernet connector. Use a digital voltmeter to validate the grounding. If the far end device is not grounded, add a ground wire in compliance with local electrical codes.



CAUTION: To reduce emissions, connect the far end of the Breakout cable shield to frame ground.



Perform the following steps:

1. Mount the reader.
2. Connect the Ethernet cable to a computer or a switch.
3. Connect the breakout cable to a 24 V power supply.

For information on the cable pinout and wire colors, see section *Connections, Optics, and Lighting* in the *DataMan 470 Reference Manual*.

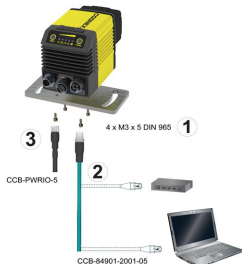

Installation

Installation procedures are detailed in the *DataMan 470 Reference Manual*, which is installed with the DataMan Setup Tool. The DataMan Setup Tool is available from the DataMan support site: <http://www.cognex.com/support/dataman>.

To access documentation, open the Windows Start menu, select *All Programs > Cognex > DataMan Software vx.x.x > Documentation*.

Note:

- Cables are sold separately.
- If a standard component is missing or damaged, immediately contact your Cognex Authorized Service Provider (ASP) or Cognex Technical Support.



CAUTION: All cable connectors are "keyed" to fit the connectors on the DataMan system; do not force the connectors or damage may occur.

1. After installing the software, connect the DataMan 470 to your PC.
2. Launch the DataMan Setup Tool and click **Refresh**.
3. Select your DataMan 470 from the list and click **Connect**.

Mounting

CAUTION: Make sure that the reader is grounded, either by mounting the reader to a fixture that is electrically grounded or by attaching a wire from the reader's mounting fixture to frame ground or Earth ground. If using a ground wire, attach it to one of the four mounting points on the back plate of the reader; not to the mounting points on the front of the reader.

Mounting the DataMan reader at a slight angle (15°) can reduce reflections and improve performance.

Use the set of mounting holes on the bottom part to mount the DataMan reader.

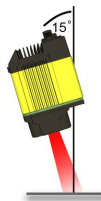

For more information on mounting, see the *DataMan 470 Reader Series Reference Manual*.

Connect the Ethernet Cable

CAUTION: Make sure that the Ethernet cable is grounded at the far end.



Whatever this cable is plugged into (usually a switch or router) should have a grounded Ethernet connector. Use a digital voltmeter to validate the grounding. If the far end device is not grounded, add a ground wire in compliance with local electrical codes.

1. Connect the Ethernet cable's M12 connector to the DataMan system's ENET connector.
2. Connect the Ethernet cable's RJ-45 connector to a switch/router or PC, as applicable.

Connect the Breakout Cable



CAUTION: To reduce emissions, connect the far end of the Breakout cable shield to frame ground.

Note:



- Make sure that the reader is not receiving power before you perform any I/O wiring or adjustments to I/O devices.
- You can clip unused wires short or use a tie made of non-conductive material to tie them back. Keep bare wires separated from the +24 VDC wire.

1. Verify that the 24 VDC power supply is unplugged and not receiving power.
 2. Attach the Breakout cable's +24 VDC and Ground to the corresponding terminals on the power supply.
-



CAUTION: Never connect voltages other than 24 VDC. Always observe the polarity shown.

3. Attach the Breakout cable's M12 connector to the DataMan 470's 24 VDC connector.
4. Restore power to the 24 VDC power supply and turn it on if necessary.

DataMan 470 Specifications

Specification	DataMan 470	
Weight	373 g with S-mount adapter, without rubber front cover	
Power Consumption	<ul style="list-style-type: none"> • 24 VDC \pm10%, 1.5 A maximum (HPIL* and HPIT**) • 24 VDC , 250 mA maximum (non-HPIL)* • 24 VDC, 1000 mA (HPIA)*** <p>Supplied by LPS or NEC class 2 only.</p> <p>*HPIL denotes one of the DM360-HPIL-xxx-xx or DMLT-HPIL-xxx-xx accessories. **HPIT denotes one of the DMLT-HPIT-xxx-xx accessories. ***HPIA denotes one of the DM30X-HPIA3-xxx-xx accessories.</p>	
Light Connector	Output Voltage	20 V – 26.4 V Voltage may drop below nominal input voltage depending cable length.
	Max avg Current	1 A
	Peak Operating Current	1.5 A up to 100 μ s, avg to not exceed 1 A
	Max Inrush Current	5 A not exceeding 0.4 As
Case Temperature ¹	0°C – 57°C (32°F – 134.6°F)	
Operating Temperature ²	0 °C – 40°C (32 °F – 104°F)	
Storage Temperature	-20°C – 80°C (-4°F – 176°F)	
Humidity	< 95% non-condensing	
Environmental	IP67 with cables and appropriate lens cover attached.	

¹ Additional cooling measures may be required to keep the case temperature from exceeding 50°C. Examples of such measures include: extra heat sinking and/or air movement.

² In situations where the operating temperature exceeds 40 °C, an external heat sink is required.

Specification	DataMan 470		
Shock (Shipping and Storage)	IEC 60068-2-27: 18 shocks (3 shocks in each polarity in each (X, Y, Z) axis) 80 Gs (800 m/s ² at 11 ms, half-sinusoidal) with cables or cable plugs and appropriate lens cover attached.		
Vibration (Shipping and Storage)	IEC 60068-2-6: vibration test in each of the three main axis for 2 hours @ 10 Gs (10 to 500 Hz at 100 m/s ² / 15 mm) with cables or cable plugs and appropriate lens cover attached.		
RS-232	Rx/D, Tx/D according to TIA/EIA-232-F		
Codes	DataMan 474		DataMan 475
	1-D barcodes: Codabar, Code 39, Code 128, and Code 93, Interleaved 2 of 5, MSI, UPC/EAN/JAN, Code25 2-D codes: Data Matrix (IDMax and IDQuick: ECC 0, 50, 80, 100, 140, and 200), QR Code and microQR Code, MaxiCode, DotCode Stacked codes: PDF 417, Micro PDF		1-D barcodes: Codabar, Code 39, Code 128, and Code 93, Interleaved 2 of 5, MSI, UPC/EAN/JAN, Code25 2-D codes: Data Matrix (IDMax and IDQuick: ECC 0, 50, 80, 100, 140, and 200), QR Code and microQR Code
Discrete I/O operating limits	HS Output 0,1,2,3	I_{MAX}	50 mA
		R_{MIN}	@ 12 VDC 200 Ω
	Input 0 (Trigger)	V_{IH}	$\pm 15 - \pm 28$ V
	Input 1,2,3	V_{IL}	0 — ± 5 V
		I_{TYP}	@ 12 VDC 2.0 mA @ 24 VDC 4.2 mA
Ethernet Speed	10/100/1000		
Duplex Mode	Full duplex or half duplex		

DataMan 470 Series Reader Imager Specifications

Specification	DataMan 474 Imager	DataMan 475 Imager
Image Sensor	1/1.8 inch CMOS	2/3 inch CMOS, global shutter
Image Sensor Properties	7.2 mm x 5.4 mm (H x V); 3.45 μ m square pixels	8.8 mm x 6.6 mm (H x V); 3.45 μ m square pixels
Image Resolution (pixels)	2048 x 1536	2448 x 2048
Electronic Shutter Speed	Minimum exposure: 15 μ s Maximum exposure: 25 ms with internal illumination/100000 μ s with external illumination	Minimum exposure: 15 μ s Maximum exposure: 25 ms with internal illumination/100000 μ s with external illumination
Image Acquisition at Full Resolution	Max. 55 Hz	Max. 37 Hz
Lens Type	See <i>DataMan 470 Series Accessories</i> on page 5	

Limitations to C-Mount lenses:

- The length of the thread cannot exceed 5.4 mm.
- For a chosen lens, the distance from the C-mount shoulder to the bottom of the lens cannot exceed 5.4 mm. Use a lens spacer if necessary.
- When using the C-Mount lens cover, lens dimensions including spacer and filters cannot exceed 32 x 42 mm (diameter x length).

LED and Laser Wavelengths

The following table shows LED types and the related peak wavelengths:

LED	λ [nm]
WHITE	6500K (Color Temperature)
BLUE	470
RED	617
HIGH POWER RED	617
IR	850
TORCHLIGHT - WHITE	2500-5000K (Color Temperature)
TORCHLIGHT - RED	625

Regulations/Conformity

Note: For the most current CE and UKCA declaration and regulatory conformity information, see the Cognex support site: cognex.com/support.

DataMan 470 has Regulatory Model R00062, and meet or exceed the requirements of all applicable standards organizations for safe operation. However, as with any electrical equipment, the best way to ensure safe operation is to operate them according to the agency guidelines that follow. Please read these guidelines carefully before using your device.

Safety and Regulatory	
Manufacturer	Cognex Corporation One Vision Drive Natick, MA 01760 USA
USA	TÜV SÜD SCC/NRTL OSHA Scheme for UL/CAN 61010-1. FCC Part 15, Class A This equipment has been tested and found to comply with the limits for a Class A digital device, pursuant to part 15 of the FCC Rules. These limits are designed to provide reasonable protection against harmful interference when the equipment is operated in a commercial environment. This equipment generates, uses, and can radiate radio frequency energy and, if not installed and used in accordance with the instruction manual, may cause harmful interference to radio communications. Operation of this equipment in a residential area is likely to cause harmful interference in which case the user will be required to correct the interference at his own expense.
Canada	TÜV SÜD SCC/NRTL OSHA Scheme for UL/CAN 61010-1. ICES-003, Class A This Class A digital apparatus complies with Canadian ICES-003. Cet appareil numérique de la classe A est conforme à la norme NMB-003 du Canada.

Safety and Regulatory

Europe	<p> CAUTION: This is a class A product. In a domestic environment this product may cause radio interference in which case the user may be required to take adequate measures.</p> <hr/> <p>The CE mark on the product indicates that the system has been tested to and conforms to the provisions noted within the 2014/30/EU Electromagnetic Compatibility Directive and the 2011/65/EU RoHS Directive. For further information, please contact: Cognex Corporation, One Vision Drive, Natick, MA 01760, USA. Cognex Corporation shall not be liable for use of our product with equipment (i.e., power supplies, personal computers, etc.) that is not CE.</p>
Korea	<p>A급 기기(업무용 방송통신기자재): 이 기기는 업무용(A급) 전자파적합기로서 판매자 또는 사용자는 이 점을 주의하시기 바라며, 가정외의 지역에서 사용하는 것을 목적으로 합니다. For DataMan 474 with Regulatory Model R00062: R-REM-CGX-R00062.</p>
International Product Safety	<p>Conforms to IEC 61010-1, CAN/CSA-C22.2 No. 61010-1:2012 + UPD No. 1:2015-07, UL 61010-1:2012 + R:2015-07, UL 61010-1:2012 + R:2015-07, EN 61010-1:2010.</p>
CB	<p>TÜV SÜD, IEC/EN 61010-1. CB report available upon request.</p>

For European Community Users

Cognex complies with Directive 2012/19/EU OF THE EUROPEAN PARLIAMENT AND OF THE COUNCIL of 4 July 2012 on waste electrical and electronic equipment (WEEE).

This product has required the extraction and use of natural resources for its production. It may contain hazardous substances that could impact health and the environment, if not properly disposed.

In order to avoid the dissemination of those substances in our environment and to diminish the pressure on the natural resources, we encourage you to use the appropriate take-back systems for product disposal. Those systems will reuse or recycle most of the materials of the product you are disposing in a sound way.



The crossed out wheeled bin symbol informs you that the product should not be disposed of along with municipal waste and invites you to use the appropriate separate take-back systems for product disposal.

If you need more information on the collection, reuse, and recycling systems, please contact your local or regional waste administration.

You may also contact your supplier for more information on the environmental performance of this product.

中国大陆RoHS (Information for China RoHS Compliance)

根据中国大陆《电子信息产品污染控制管理办法》(也称为中国大陆RoHS), 以下部份列出了本产品中可能包含的有毒有害物质或元素的名称和含量。



Table of toxic and hazardous substances/elements and their content, as required by China's management methods for controlling pollution by electronic information products.

	Hazardous Substances 有害物质					
Part Name 部件名称	Lead (Pb) 铅	Mercury (Hg) 汞	Cadmium (Cd) 镉	Hexavalent Chromium (Cr (VI)) 六价铬	Polybrominated biphenyls (PBB) 多溴联苯	Polybrominated diphenyl ethers (PBDE) 多溴二苯醚
Regulatory Model R00062	X	O	O	O	O	O
<p>This table is prepared in accordance with the provisions of SJ/T 11364. 这个标签是根据SJ/T 11364的规定准备的。</p> <p>O: Indicates that said hazardous substance contained in all of the homogeneous materials for this part is below the limit requirement of GB / T26572 - 2011. 表示本部件所有均质材料中含有的有害物质低于GB / T26572 - 2011 的限量要求。</p> <p>X: Indicates that said hazardous substance contained in at least one of the homogeneous materials used for this part is above the limit requirement of GB / T26572 - 2011. 表示用于本部件的至少一种均质材料中所含的有害物质超过GB / T26572 - 2011 的限制要求。</p>						

Copyright © 2025
Cognex Corporation. All Rights Reserved.

