

DataMan[®] 390 Series Reference Manual



2025 July 30
Revision: 25.3.1.2

Legal Notices

The software described in this document is furnished under license, and may be used or copied only in accordance with the terms of such license and with the inclusion of the copyright notice shown on this page. Neither the software, this document, nor any copies thereof may be provided to, or otherwise made available to, anyone other than the licensee. Title to, and ownership of, this software remains with Cognex Corporation or its licensor. Cognex Corporation assumes no responsibility for the use or reliability of its software on equipment that is not supplied by Cognex Corporation. Cognex Corporation makes no warranties, either express or implied, regarding the described software, its merchantability, non-infringement or its fitness for any particular purpose.

The information in this document is subject to change without notice and should not be construed as a commitment by Cognex Corporation. Cognex Corporation is not responsible for any errors that may be present in either this document or the associated software.

Companies, names, and data used in examples herein are fictitious unless otherwise noted. No part of this document may be reproduced or transmitted in any form or by any means, electronic or mechanical, for any purpose, nor transferred to any other media or language without the written permission of Cognex Corporation.

Copyright © 2025. Cognex Corporation. All Rights Reserved.

Portions of the hardware and software provided by Cognex may be covered by one or more U.S. and foreign patents, as well as pending U.S. and foreign patents listed on the Cognex web site at: cognex.com/patents.

The following are registered trademarks of Cognex Corporation:

Cognex, 2DMAX, Advantage, AlignPlus, Assemblyplus, Check it with Checker, Checker, Cognex Vision for Industry, Cognex VSOC, CVL, DataMan, DisplayInspect, DVT, EasyBuilder, Hotbars, IDMax, In-Sight, Laser Killer, MVS-8000, OmniView, PatFind, PatFlex, PatInspect, PatMax, PatQuick, SensorView, SmartView, SmartAdvisor, SmartLearn, UltraLight, Vision Solutions, VisionPro, VisionView

The following are trademarks of Cognex Corporation:

The Cognex logo, 1DMax, 3D-Locate, 3DMax, BGAll, CheckPoint, Cognex VSoC, CVC-1000, FFD, iLearn, In-Sight (design insignia with cross-hairs), In-Sight 2000, InspectEdge, Inspection Designer, MVS, NotchMax, OCRMax, PatMax RedLine, ProofRead, SmartSync, ProfilePlus, SmartDisplay, SmartSystem, SMD4, VisiFlex, Xpand

Portions copyright © Microsoft Corporation. All rights reserved.

Portions copyright © MadCap Software, Inc. All rights reserved.

Other product and company trademarks identified herein are the trademarks of their respective owners.

Precautions

To reduce the risk of injury or equipment damage, observe the following precautions when you install the Cognex product:

- Connectivity is possible through the following options:
 - 24 VDC (+/- 10%) output connection using a UL or NTRL listed power supply

Any other voltage creates a risk of fire or shock and can damage the components. Applicable national and local wiring standards and rules must be followed.

- This product is intended for industrial use in automated manufacturing or similar applications.
- The safety of any system incorporating this product is the responsibility of the assembler of the system.
- Do not install Cognex products where they are exposed to environmental hazards such as excessive heat, dust, moisture, humidity, impact, vibration, corrosive substances, flammable substances, or static electricity.
- Route cables and wires away from high-current wiring or high-voltage power sources to reduce the risk of damage or malfunction from the following causes: over-voltage, line noise, electrostatic discharge (ESD), power surges, or other irregularities in the power supply.
- Do not expose the image sensor to laser light. Image sensors can be damaged by direct, or reflected, laser light. If your application requires laser light that might strike the image sensor, use a lens filter at the corresponding laser wavelength. For suggestions, contact your local integrator or application engineer.
- This product does not contain user-serviceable parts. Do not make electrical or mechanical modifications to product components. Unauthorized modifications can void your warranty.
- Changes or modifications not expressly approved by the party responsible for regulatory compliance could void the user's authority to operate the equipment.
- Include service loops with cable connections.
- Ensure that cable strain relief is applied within strain relief zone. The strain relief zone is between two inches to six inches from the connector.
- Ensure that the cable bend radius begins at least six inches from the connector. Cable shielding can be degraded or cables can be damaged or wear out faster if a service loop or bend radius is tighter than 10X the cable diameter.
- This device should be used in accordance with the instructions in this manual.
- All specifications are for reference purposes only and can change without notice.

Symbols

The following symbols indicate safety precautions and supplemental information:

 **WARNING:** This symbol indicates a hazard that could cause death, serious personal injury or electrical shock.

 **CAUTION:** This symbol indicates a hazard that could result in property damage.

 **Note:** This symbol indicates additional information about a subject.

 **Tip:** This symbol indicates suggestions and shortcuts that might not otherwise be apparent.

Table of Contents

Legal Notices	2
Precautions	3
Symbols	4
Table of Contents	5
Getting Started	7
About the DataMan 390 Series	7
Supporting Documentation	8
Accessories	9
Lenses	9
Lens Covers	9
Mounting Brackets	10
Cables	10
External Lights	11
Integrated Lights and Accessories	11
Lens, Reader, and Light Compatibility	14
DataMan 390 Series Systems	14
Setting Up Your DataMan Reader	15
Reader Layout	15
Dimensions	17
DataMan 390 Reader Only	17
DataMan 390 with HPIT	18
DataMan 390 with 45 mm Lens Cover	19
DataMan 390 with HPIA	19
Installing Lenses and Lights	21
Install C-Mount Lens with Lens Cover	21
Installing High Speed Liquid Lens with HPIT	24
Installing HPIA	28
Field of View and Reading Distance	31
Reading Distance and Field of View of DM394	31
Reading Distance and Field of View of DM395	34
Mounting the Reader	37
Mounting Bracket (BKT-INS-01)	37
Mounting with Pivot Bracket	38
Connecting the Ethernet Cable	40
Connecting the Power and I/O Breakout Cable	40
Using Your DataMan Reader	41
Connect to DataMan WebUI	41
Install DataMan Setup Tool	42
Trigger Types	43
External Triggers	43
Industrial Protocols	44
Specifications	45
DataMan 390 Series Reader	45

DataMan 390 Series Reader Image Sensor	46
Illumination Options	46
LED and Laser Wavelengths	47
Acquisition Trigger Input	47
High-Speed Outputs	48
High Speed Output Wiring	49
Ethernet Cable	50
Breakout Cable	50
Power and I/O Breakout Cable (CCB-M12x12Fy-xx)	52
Power and I/O Breakout Cable (CCBL-05-01)	53
Power and I/O Breakout Cable (CCB-PWRIO-xx)	54
Cleaning and Maintenance	55
Clean the Housing	55
Clean the Reader Image Sensor Window	55
Clean the Reader Lens Cover	55
Regulations and Conformity	56
中国大陆RoHS (Information for China RoHS Compliance)	57
For European Community Users	57

Getting Started

This section provides general information about the DataMan 390 series reader and the accessories and systems.

About the DataMan 390 Series



The DataMan 390 series readers are high-performance, fixed-mount readers that offer:

- One-click AI tuning for the best possible setup
- AI runtime image enhancement for reading the most damaged codes
- High-speed decoding at high resolution for challenging multi-code applications

Supporting Documentation

This document provides basic information about the DataMan 390 series readers. Additional information is available through the Windows **Start** menu or the DataMan Setup Tool **Help** menu after you install the DataMan software on your PC.



Note: For the latest documentation, visit: support.cognex.com/documentation/dataman.

- The **DataMan Communications and Programming Guide** shows you how to integrate your DataMan reader into your particular automation and factory environment.
Cognex > DataMan Software v x.x.x > Documentation > Communications > DataMan Communications and Programming Guide
- The **DataMan Industrial Protocols Manual** provides information on how to integrate DataMan readers into your particular environment using industrial protocols.
Cognex > DataMan Software v x.x.x > Documentation > Communications > DataMan Industrial Protocols Manual
- The **DataMan Reader Configuration Codes** document provides printable 2-D codes that you can use to configure the DataMan reader.
Cognex > DataMan Software v x.x.x > Documentation > English > Reader Configuration Codes
- The **DM390 Quick Reference Guide** provides essential information about the DM390 reader.
Cognex > DataMan Software v x.x.x > Documentation > English > DM390 Series > DM390 Quick Reference Guide
- The **DataMan Fixed-Mount Readers Reference** is a complete online hardware reference for the DataMan fixed-mount ID readers.
Cognex > DataMan Software v x.x.x > Documentation > English > DM390 > Fixed-Mount Reference Manual
- The **DataMan Questions and Answers** document provides context-sensitive information. You can view this help inside the DataMan Setup Tool or as a stand-alone help file.
Cognex > DataMan Software v x.x.x > Documentation > DM390 > Questions and Answers
- The **DataMan Control Commands** lists DataMan Control Commands with all relevant information. You can view this help inside the Setup Tool or as a stand-alone help file.
Cognex > DataMan Software v x.x.x > Documentation > English > DataMan Control Commands
- The **Setup Tool Reference Manual** describes the user interface of the DataMan Setup Tool software.
Cognex > DataMan Software v x.x.x > Documentation > English > Setup Tool Reference Manual
- The **Release Notes** list detailed system requirements and additional information about the DataMan software release.
Cognex > DataMan Software v x.x.x > Documentation > DataMan v x.x.x Release Notes

Accessories





You can purchase the following components separately. For a list of options and accessories, contact your local Cognex sales representative.

Lenses



Accessory	Product Number	Illustration
8 mm f8 Cognex High Speed Liquid Lens Note: No IR Blocking filter.	CLN-C08F8FS-HSLL	
10 mm f5 Cognex High Speed Liquid Lens with Visible and IR Note: No IR Blocking filter.	CLN-C10F5FS-HSLL	
16 mm f8 Cognex High Speed Liquid Lens with Visible and IR Note: No IR Blocking filter.	CLN-C16F8FS-HSLL	
24 mm f6 Cognex High Speed Liquid Lens with Visible and IR Note: No IR Blocking filter.	CLN-C24F6FS-HSLL	
35 mm f8 Cognex High Speed Liquid Lens Note: No IR Blocking filter.	CLN-C35F8FS-HSLL	
8 mm Variable Aperture Moritex UR Series	ML-M0822UR	
12 mm Variable Aperture Moritex UR Series	ML-M1218UR	
16 mm Variable Aperture Moritex UR Series	ML-M1616UR	
25 mm Variable Aperture Moritex UR Series	ML-M2516UR	
35 mm Variable Aperture Moritex UR Series	ML-M3520UR	

Note: For lens and light compatibility, see [Lens, Reader, and Light Compatibility on page 14](#).

Lens Covers





Accessory	Product Number	Illustration
45 mm Plastic Lens Cover	COV-380-CMNT-45	
60 mm Plastic Lens Cover	COV-380-CMNT-60	
75 mm Plastic Lens Cover	COV-380-CMNT-75	
30 mm Lens Cover Extender	COV-7000-CMNT-LGX	

Mounting Brackets



Accessory	Product Number	Illustration
Pivot mounting bracket	DMBK-PIVOT-DM380	
Mounting bracket with M3, M4 and 1/4 - 20 mounting holes	BKT-INS-01	

Cables





Note: Cables are sold separately.

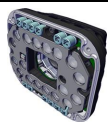

Accessory	Product Number	Illustration
Ethernet Cable, X-coded M12-8 to RJ-45	CCB-84901-2001-xx (straight, xx specifies length: 2m, 5m, 10m, 15m, 30m)	
Ethernet Cable, X-coded M12-8 to RJ-45	CCB-84901-2002-xx (right-angled, xx specifies length: 2m, 5m, 10m)	
Ethernet Cable, Robotic X-Coded M12-8 to RJ-45	CCB-84901-2RBT-xx (straight, xx specifies length: 2m, 5m, 10m)	
X-Coded to A-Coded Ethernet cable adapter, 0.5 m	CCB-M12X8MS-XCAC	
Power and I/O Breakout Cable, M12-12 to Flying Lead	CCB-M12x12Fy-xx (y = straight/angled, xx specifies length)	
Power and I/O Breakout Cable, M12-12 to Flying Lead	CCBL-05-01	
Power and I/O Breakout Cable, M12-12 to Flying Lead	CCB-PWRIO- xx (straight, xx specifies length: 5m, 10m, 15m)	
Power and I/O Breakout Cable, M12-12 to Flying Lead	CCB-PWRIO-xxR (right-angled, xx specifies length: 5m, 10m, 15m)	
Power and I/O Breakout Cable, M12-12 to DB15	CCB-PWRIO-MOD-xx (xx specifies length: 2m, 5m)	
RS-232 Connection Cable	CCB-M12xDB9Y-05	

External Lights

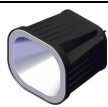
Accessory	Product Number	Illustration
Brick light, narrow red	IVSL-ODDM-S75-625	
Bar light, wide red	IVSL-YLW2X-625	
Bar light, narrow red, linear polarizer	IVSL-YLW2X-625P	
Bar light, wide red	IVSL-YLW300-625 W	
Bar light, blue	IVSL-LX520-470	

Integrated Lights and Accessories

Accessory	Product Number	Illustration
High Power Integrated Torch (HPIT), Red, wide (Risk Group Red LED exempt risk acc. IEC 62471)	DMLT-HPIT-RE-W	
HPIT, Red, standard (Risk Group Red LED exempt risk acc. IEC 62471)	DMLT-HPIT-RE-S	
HPIT, Red, narrow (Risk Group Red LED exempt risk acc. IEC 62471)	DMLT-HPIT-RE-N	
HPIT, White, wide (Risk Group White LED low risk acc. IEC 62471)	DMLT-HPIT-WHI-W	
HPIT, White, standard (Risk Group White LED low risk acc. IEC 62471)	DMLT-HPIT-WHI-S	
HPIT, White, narrow (Risk Group White LED low risk acc. IEC 62471)	DMLT-HPIT-WHI-N	
Fully polarized front cover	DMLA-HPIT-PLCOV-F	
Partially polarized front cover	DMLA-HPIT-PLCOV	
Clear front cover	DMLA-HPIT-CLCOV	
Diffuse front cover	DMLA-HPIT-DLCOV	
Passive Dome front cover	DMLA-HPIT-DFCOV	
HPIT Adapter (includes PCB light port adapter and screws)	DMLA-HPIT-ADAP390	

Accessory	Product Number	Illustration
High power Illumination Accessory (HPIA), Red, narrow (Risk Group White LED low risk acc. IEC 62471)	DM30X-HPIA3-625	
HPIA, Red, wide (Risk Group White LED low risk acc. IEC 62471)	DM30X-HPIA3-625-W	
HPIA, White, narrow (Risk Group White LED low risk acc. IEC 62471)	DM30X-HPIA3-WHI-W	
HPIA, White, wide (Risk Group White LED low risk acc. IEC 62471)	DM30X-HPIA3-WHI-W	
HPIA, Blue, narrow (Risk Group White LED low risk acc. IEC 62471)	DM30X-HPIA3-470	
HPIA, Blue, wide (Risk Group White LED low risk acc. IEC 62471)	DM30X-HPIA3-470-W	
HPIA, Infrared, narrow (Risk Group White LED low risk acc. IEC 62471)	DM30X-HPIA3-IR	
HPIA, Infrared, wide (Risk Group White LED low risk acc. IEC 62471)	DM30X-HPIA3-IR-W	
HPIA C-mount Lens Cover	DM300-CMCOV-SH	
Linear Polarizer Kit	DM30X-HPIA3-LP	

WARNING: High-Powered Integrated Torch devices equipped with a Time-of-Flight sensor, the device has been tested to be under the limits of a Class 1 Laser device. Wavelength 930-950 nm invisible laser radiation.



CAUTION: High-Powered Integrated Torch devices equipped with a target aimer have been tested in accordance with IEC 60825-1. 3rd ed. 2014, and have been certified to be under the limits of a Class 2 Laser device. Wavelength 515 nm laser radiation.

LASER LIGHT - DO NOT STARE INTO BEAM
CLASS 2 LASER PRODUCT 650nm<1mW
CLASSIFIED PER IEC 60825-1, Ed 3, 2014



Complies with FDA performance standards for laser products except for deviations pursuant to Laser Notice No. 50, dated June 24, 2007



Lens, Reader, and Light Compatibility

The following tables detail the compatibility between different lenses and lights.

High Power Integrated Torch and High Speed Liquid Lens compatibility

This configuration is not compatible with C-mount lenses.

		8 mm f8 HSL	10 mm f5 HSL	16 mm f8 HSL	24 mm f6 HSL	35 mm f8 HSL
HPIT (any color)	Wide	✓	✓	✓		
		Note: ⓘ Only compatible with the DM394 (3MP).				
	Standard				✓	
	Narrow					✓

High Power Illumination Accessory and Moritex lens compatibility

This configuration is not compatible with High Speed Liquid Lenses.

		8 mm Variable Aperture Moritex	12 mm Variable Aperture Moritex	16 mm Variable Aperture Moritex	25 mm Variable Aperture Moritex	35 mm Variable Aperture Moritex
HPIA (any color)	Wide	✓	✓	✓		
		Note: ⓘ Only compatible with the DM394 (3MP).				
	Narrow				✓	✓

DataMan 390 Series Systems

	Omnidirectional 1D Codes	Omnidirectional 1D/2D Codes	Multi-Reader Sync	Resolution (Pixels)
DM394	✓	✓	✓	2048 x 1536
DM395	✓	✓	✓	2448 x 2048

Setting Up Your DataMan Reader

Read this section to learn how the reader connects to its standard components and accessories.

Reader Layout

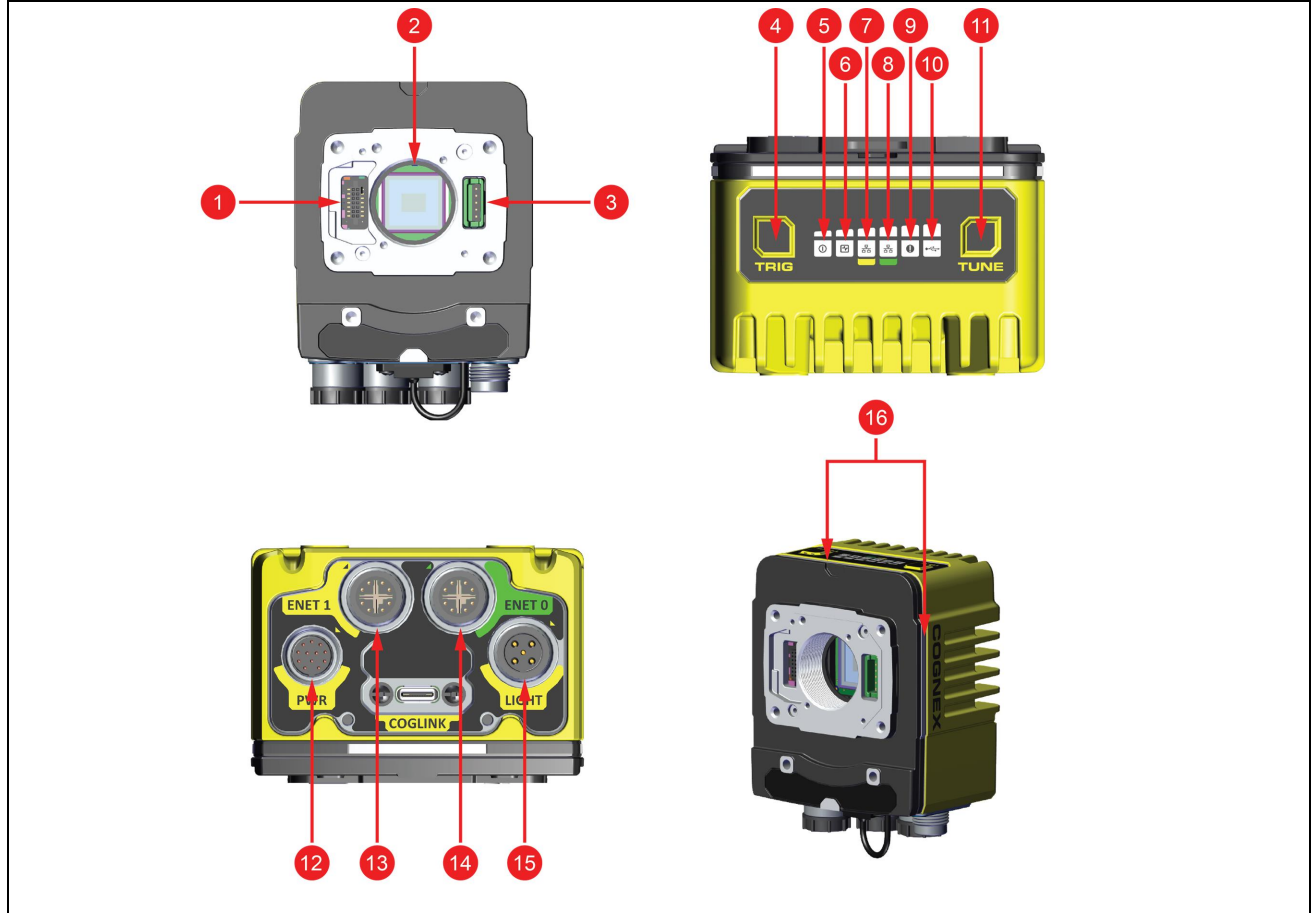

Number	Description
1	Integrated Illumination connector
2	Imager/C-mount flange
3	Lens connector
4	Trigger button
5	Power LED indicator
6	Train status LED indicator
7	Ethernet 1 status LED
8	Ethernet 0 status LED
9	Error LED indicator
10	Coglink/USB-C status LED
11	Tune button

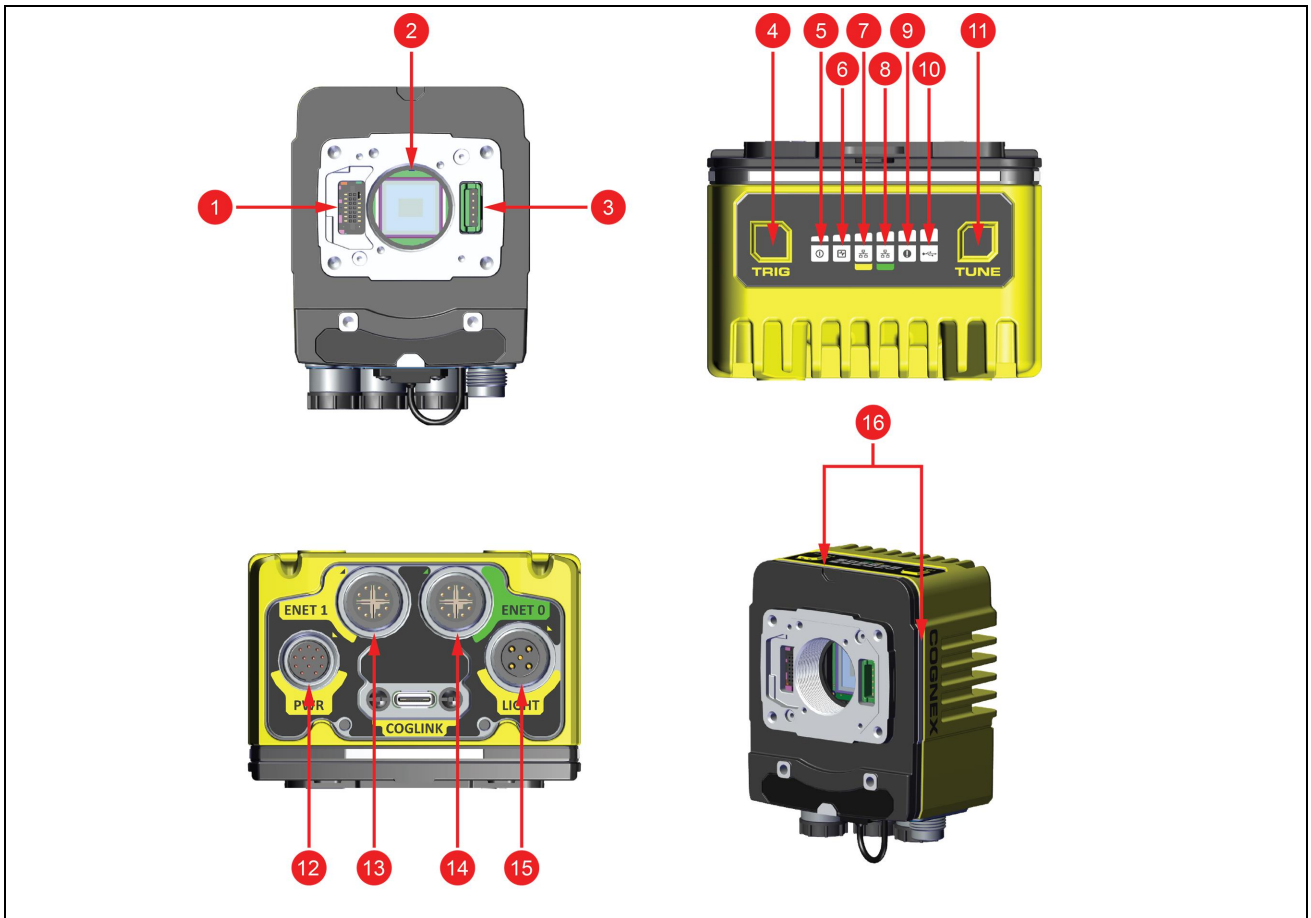

Number	Description
12	Power I/O Breakout cable connector
13	Ethernet connector 1
14	Ethernet connector 0
15	Light connector
16	Indicator lights

Dimensions

The following sections list dimensions of the reader.

Note:

- Dimensions are in millimeters [inches] and are for reference purposes only.
- All specifications are for reference purposes only and can change without notice.

DataMan 390 Reader Only

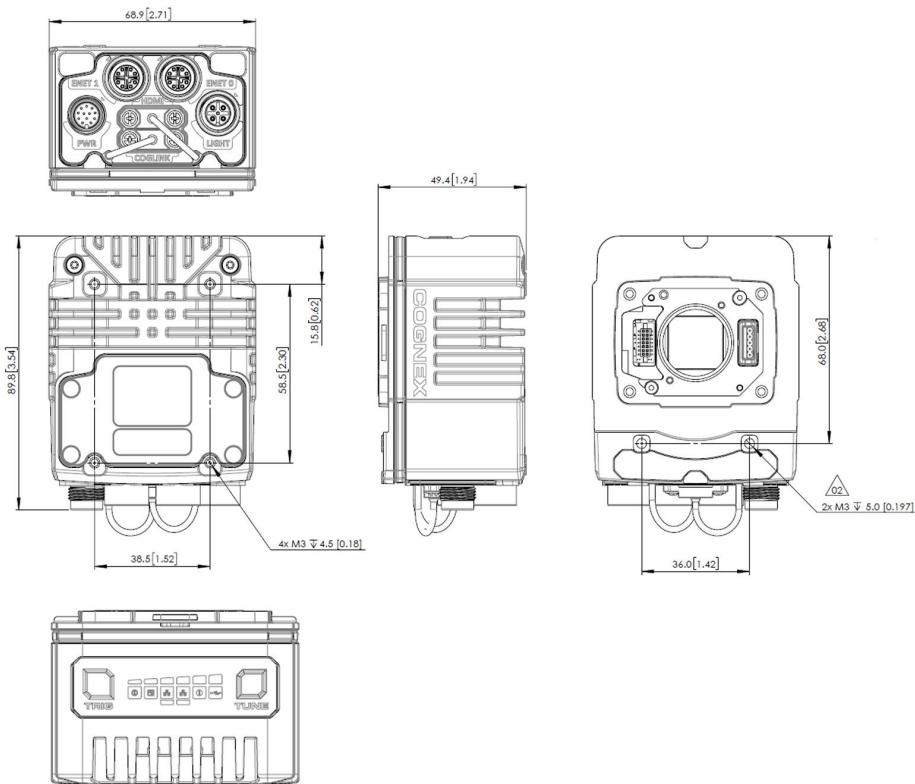

DataMan 390 with HPIT

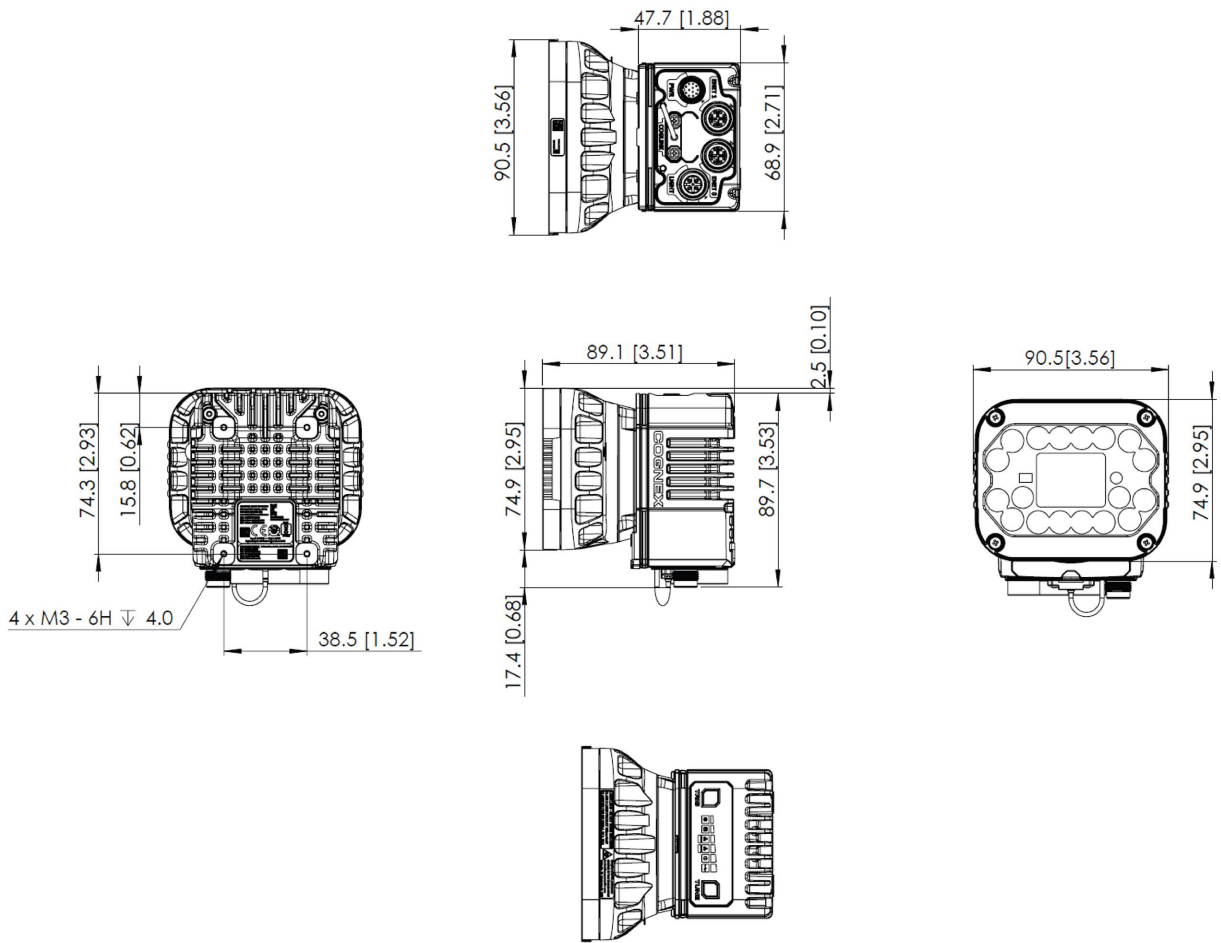

DataMan 390 with 45 mm Lens Cover

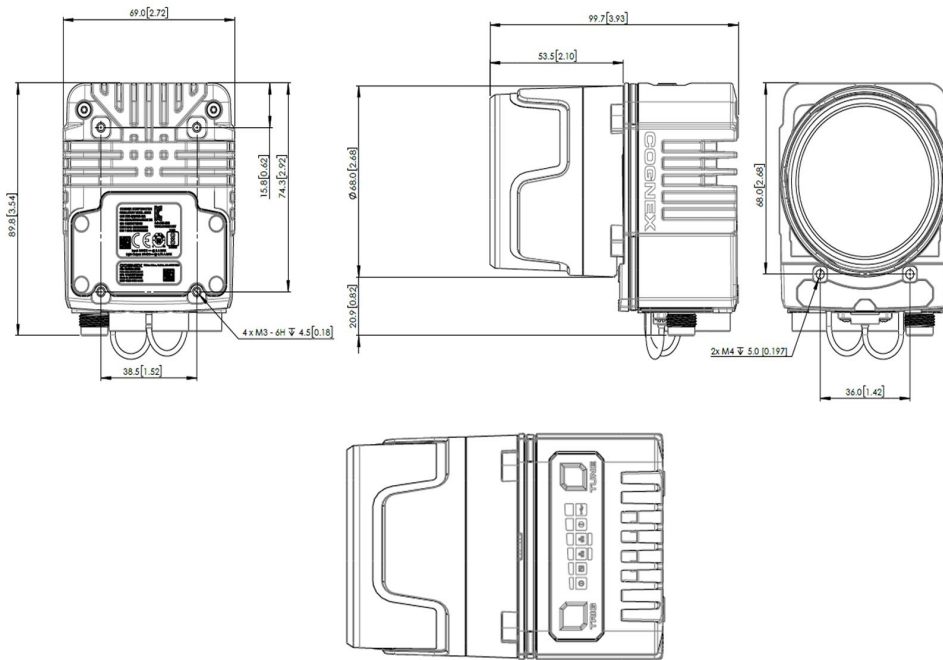

DataMan 390 with HPIA

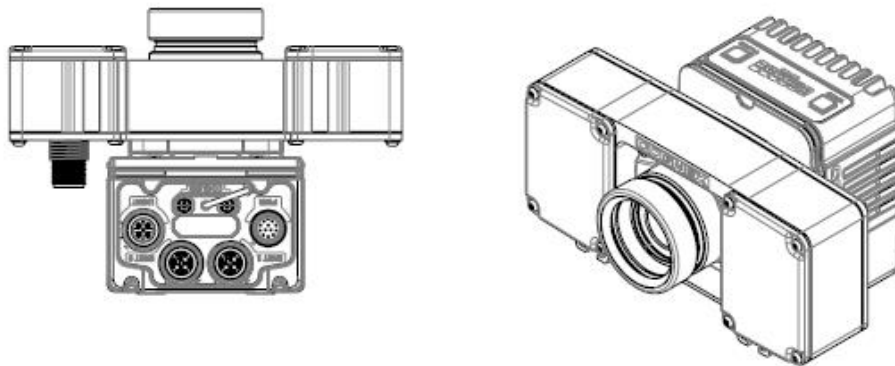

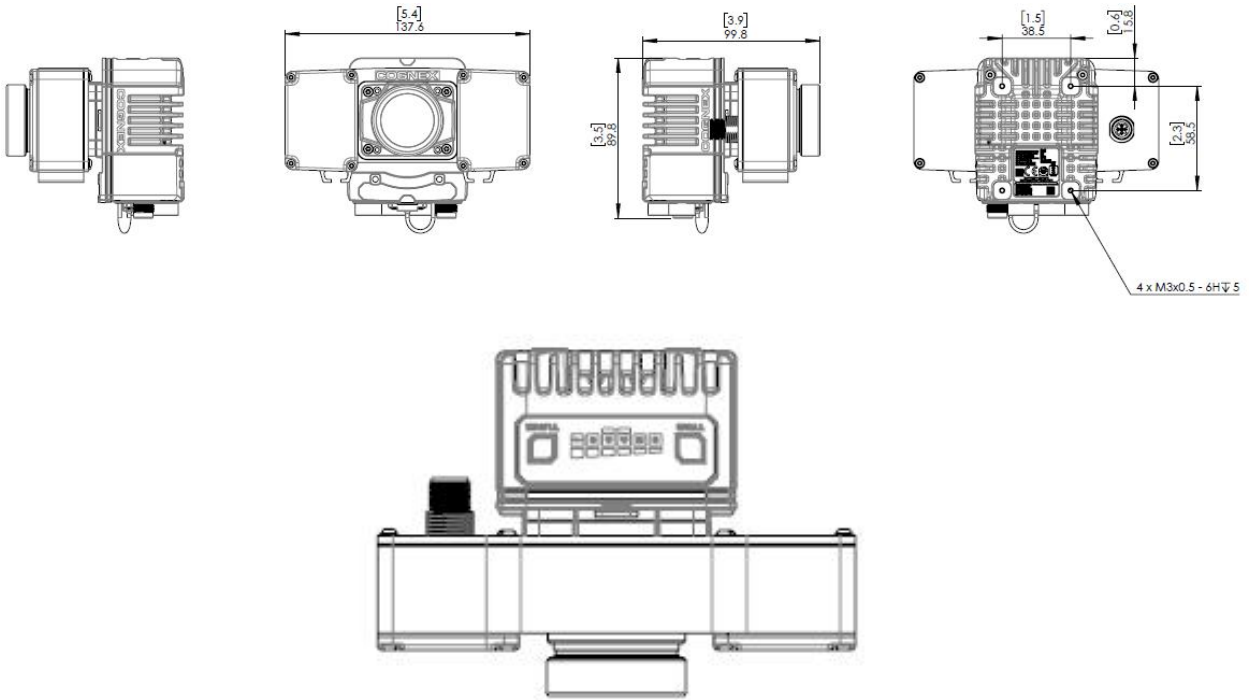

Installing Lenses and Lights

Install C-Mount Lens with Lens Cover

1. Thread the C-mount lens into the reader.



2. Place the bayonet onto the reader.

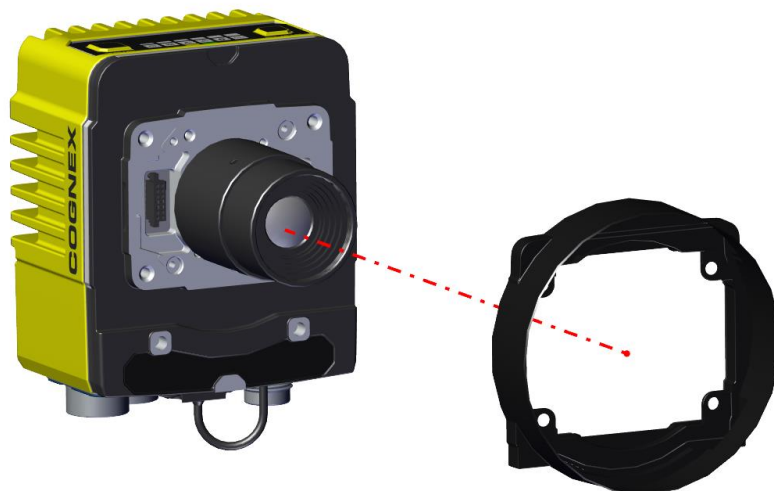

3. Screw the four screws into the reader.



4. Push the lens cover onto the bayonet mount.

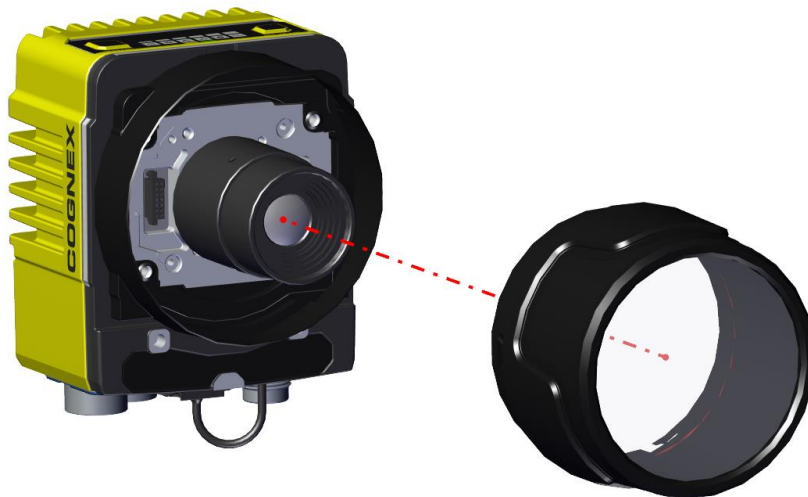

5. Rotate the lens cover into the bayonet mount.



Installing High Speed Liquid Lens with HPIT

1. Attach the small PCB into the integrated illumination connector.

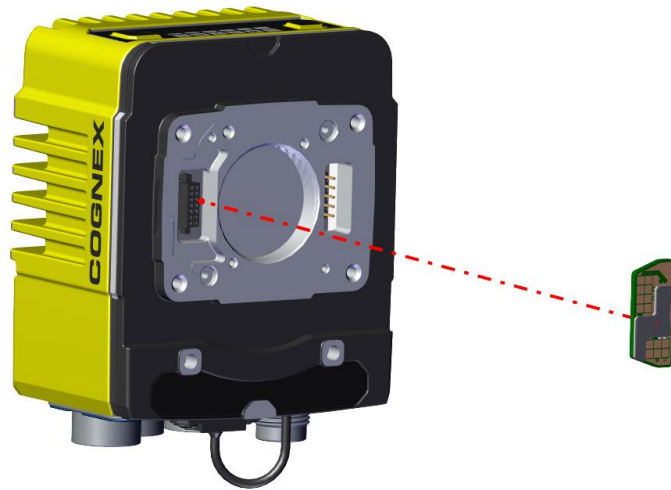

2. Attach the HPIT adapter plate and screw in the four M3 x 6 mm screws.



3. Attach the high speed liquid lens module and fix the lens with the captive screws.



4. Screw in the four M3 x 6.35 screws from the illumination module into the reader.

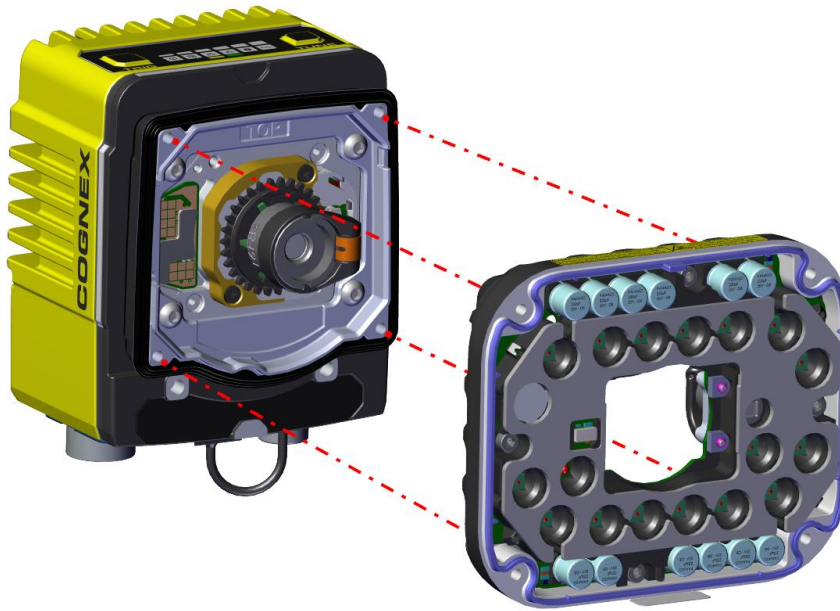

Note:
Observing the tightening sequence below, tighten all four M3 x 6.35 mm Phillips Pan screws to 0.34 Nm using a torque wrench.

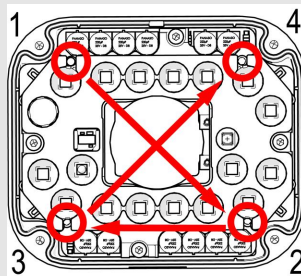

5. Attach the front cover to the illumination module by screwing in the M3 x 12 mm captive screws.

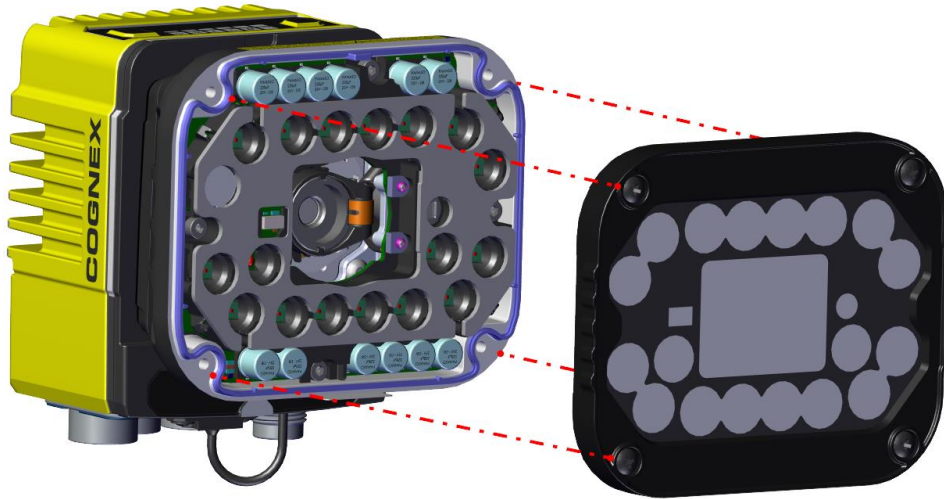

Installing HPIA

1. Place the cover plate over the lens onto the reader.

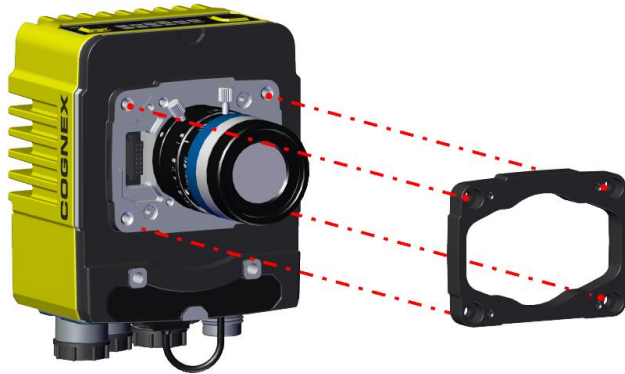

2. Place the HPIA light over the lens.



3. Remove the circular gasket from the front plate.

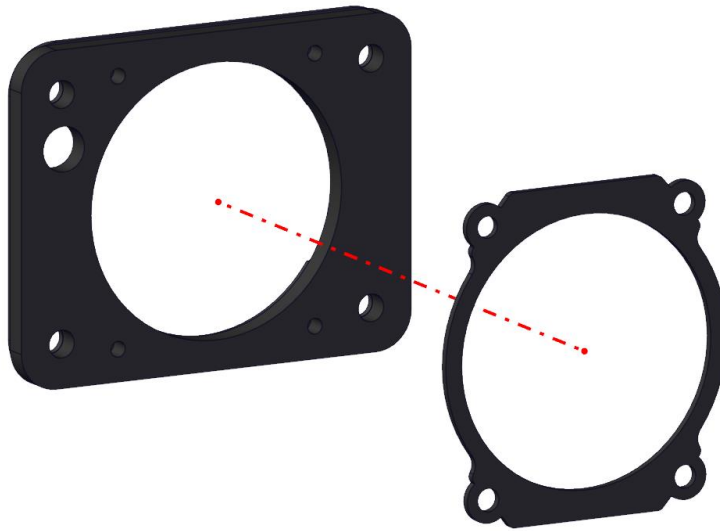

Note:
Do not remove the gasket on this side of the front plate:

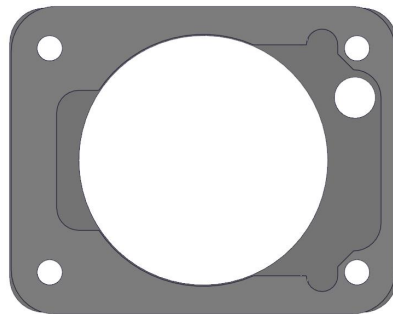

4. Place the front plate over the lens. Make sure the remaining gasket is facing the reader.



5. Place the lens cover over the lens. Tighten the M3x30 screws on the lens cover by using 50 Ncm.



Field of View and Reading Distance

This section provides the Field of View (FoV) values for the DataMan 394 and 395 models.

Note: These values are not exact minimum and maximum working distances, which are dependent on code size. Both the working distances and the focal length affect the FoV values.

Reading Distance and Field of View of DM394

3 MP with Reader with 10 mm Lens

The FoV values are shown as follows:

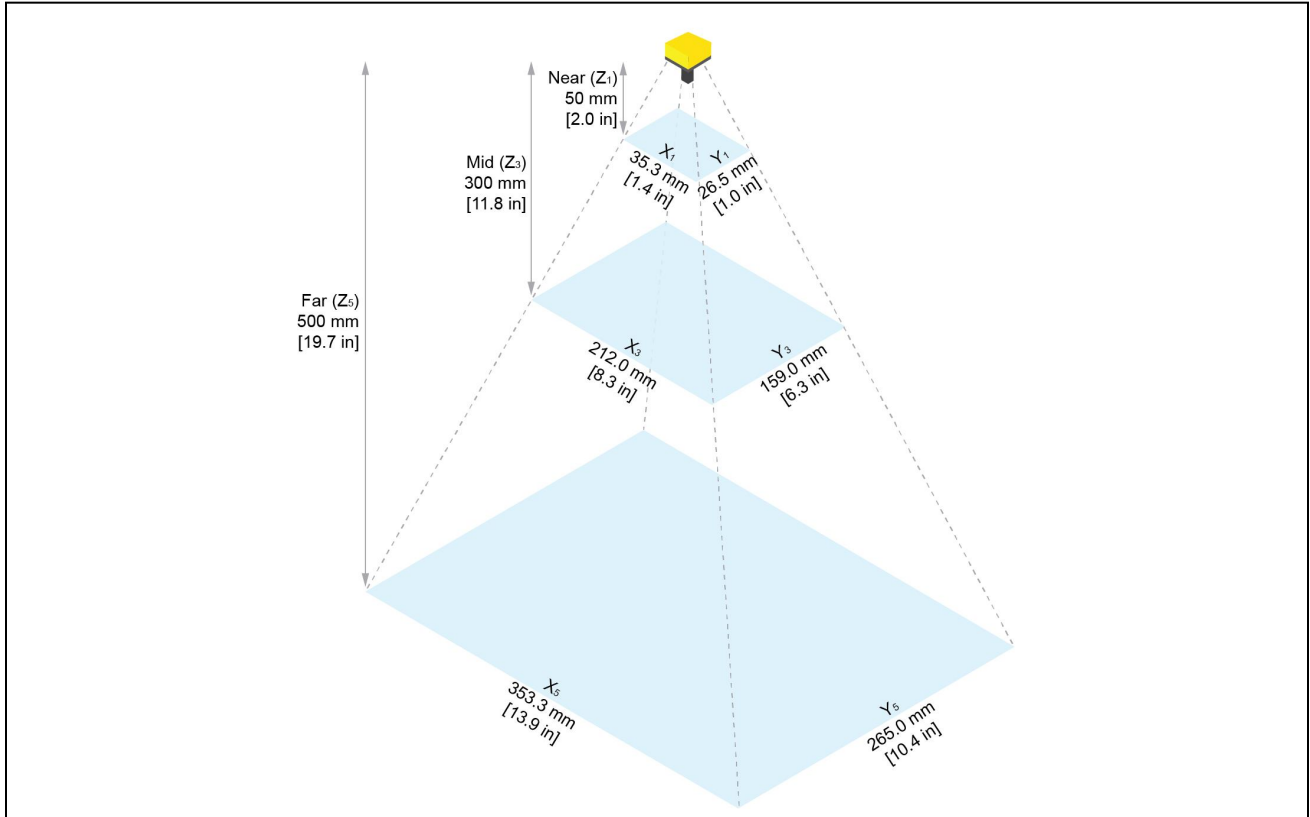

Working Distance	Horizontal Values	Vertical Values
30 mm [2.0 in]	35.3 mm [1.4 in]	26.5 mm [1.0 in]
300 mm [11.8 in]	212.0 mm [8.3 in]	159.0 mm [6.3 in]
500 mm [19.7 in]	353.3 mm [13.9 in]	265.0 mm [10.4 in]

1D Field of View table with 10 mm Lens:

1D min. code in mil	Distances in mm
4 mil	248 mm
6 mil	371 mm
10 mil	616 mm

1D min. code in mil	Distances in mm
14 mil	861 mm
20 mil	1230 mm

2D Field of View table with 10 mm Lens:

2D min. code in mil	Distances in mm
4 mil	121 mm
6 mil	180 mm
10 mil	297 mm
14 mil	415 mm
20 mil	591 mm

3 MP with Reader with 24 mm Lens

The FoV values are shown as follows:

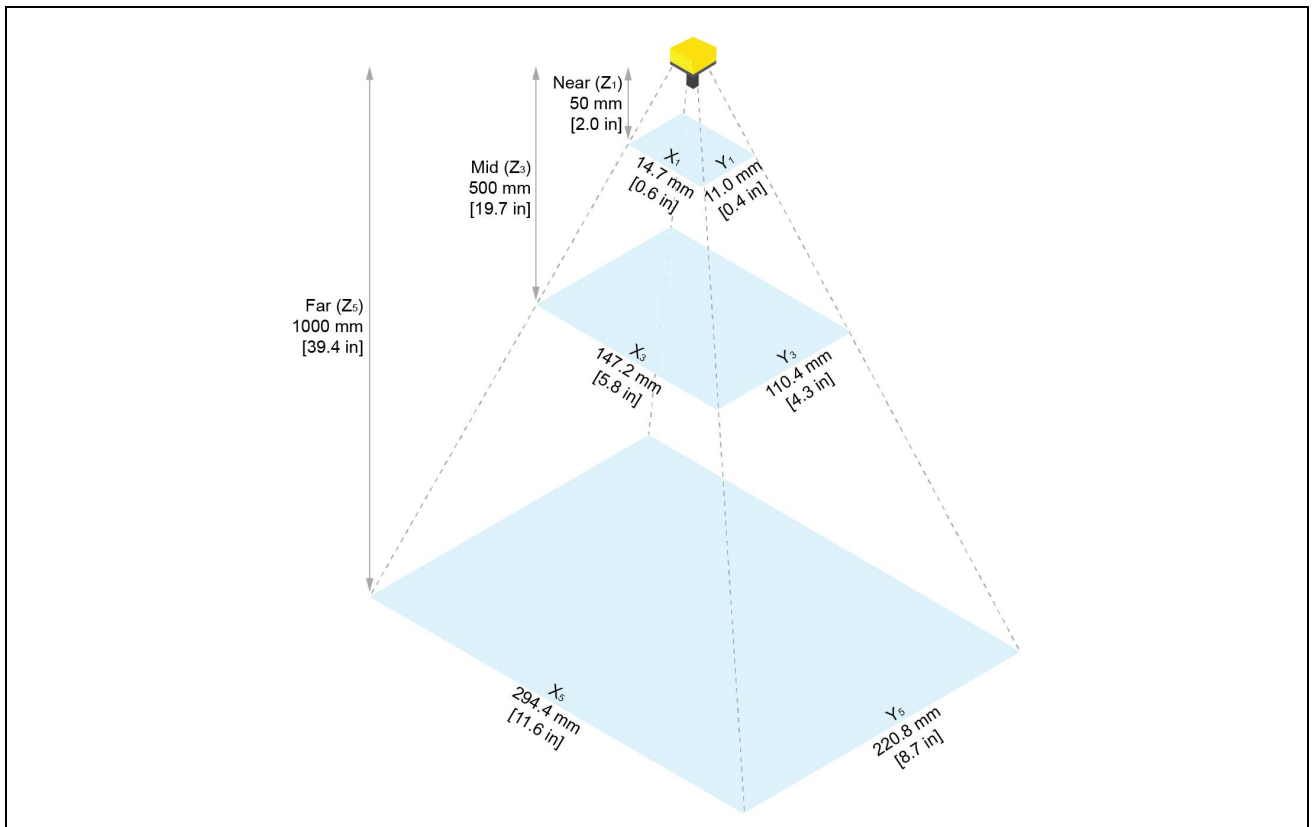

Working Distance	Horizontal Values	Vertical Values
50 mm [2.0 in]	14.7 mm [0.6 in]	11.0 mm [0.4 in]
500 mm [19.7 in]	147.2 mm [5.8 in]	110.4 mm [4.3 in]
1000 mm [39.4 in]	294.4 mm [11.6 in]	220.8 mm [8.7 in]

1D Field of View table with 24 mm Lens:

1D min. code in mil	Distances in mm
4 mil	620 mm
6 mil	915 mm
10 mil	1503 mm
14 mil	2092 mm
20 mil	2976 mm

2D Field of View table with 24 mm Lens:

2D min. code in mil	Distances in mm
4 mil	315 mm
6 mil	456 mm
10 mil	738 mm
14 mil	1020 mm
20 mil	1444 mm

Reading Distance and Field of View of DM395

5 MP with Reader with 16 mm Lens

The FoV values are shown as follows:

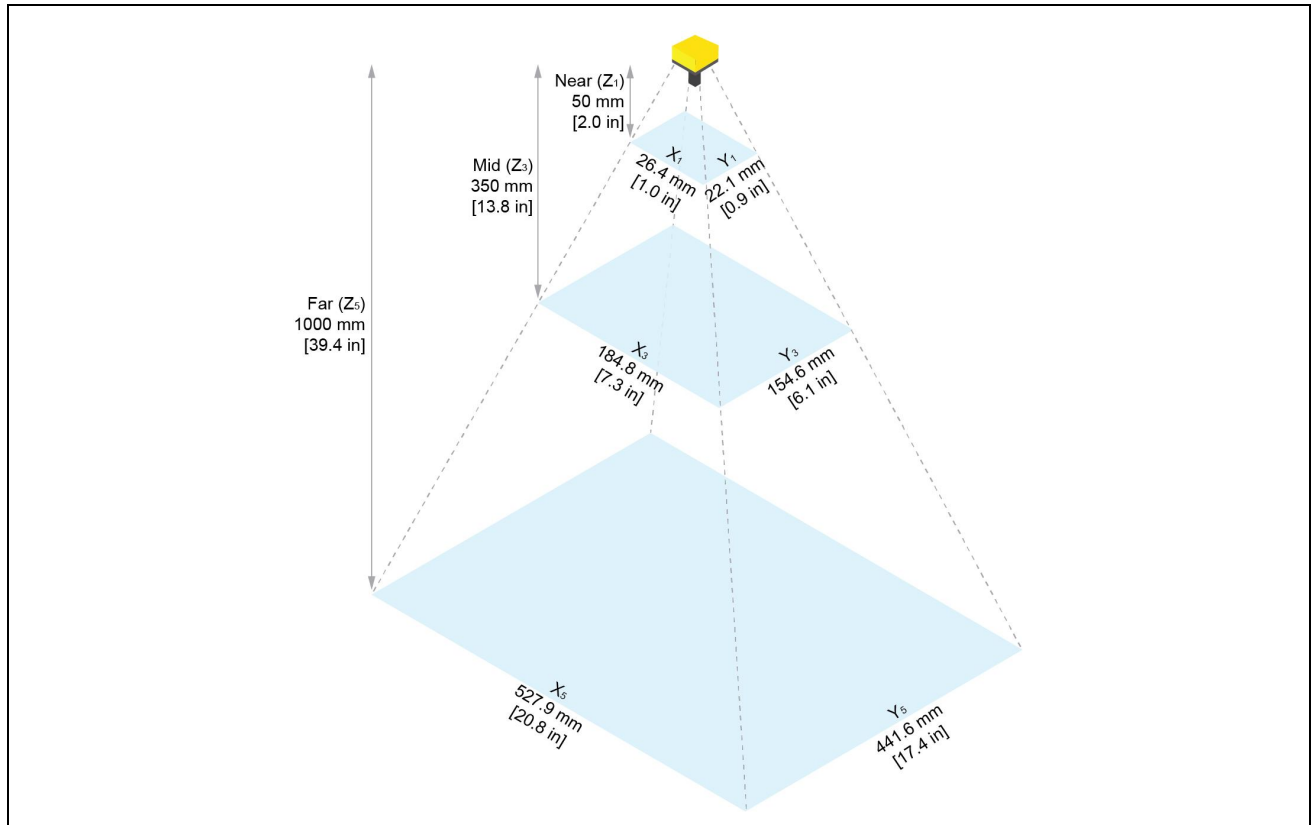

Working Distance	Horizontal Values	Vertical Values
50 mm [2.0 in]	26.4 mm [1.0 in]	22.1 mm [0.9 in]
350 mm [13.8 in]	184.8 mm [7.3 in]	154.6 mm [6.1 in]
1000 mm [39.4 in]	527.9 mm [20.8 in]	441.6 mm [17.4 in]

1D Field of View table with 16 mm Lens:

1D min. code in mil	Distances in mm
4 mil	408 mm
6 mil	604 mm
10 mil	996 mm
14 mil	1389 mm
20 mil	1978 mm

2D Field of View table with 16 mm Lens:

2D min. code in mil	Distances in mm
4 mil	204 mm
6 mil	298 mm
10 mil	486 mm
14 mil	674 mm
20 mil	957 mm

5 MP with Reader with 24 mm Lens

The FoV values are shown as follows:

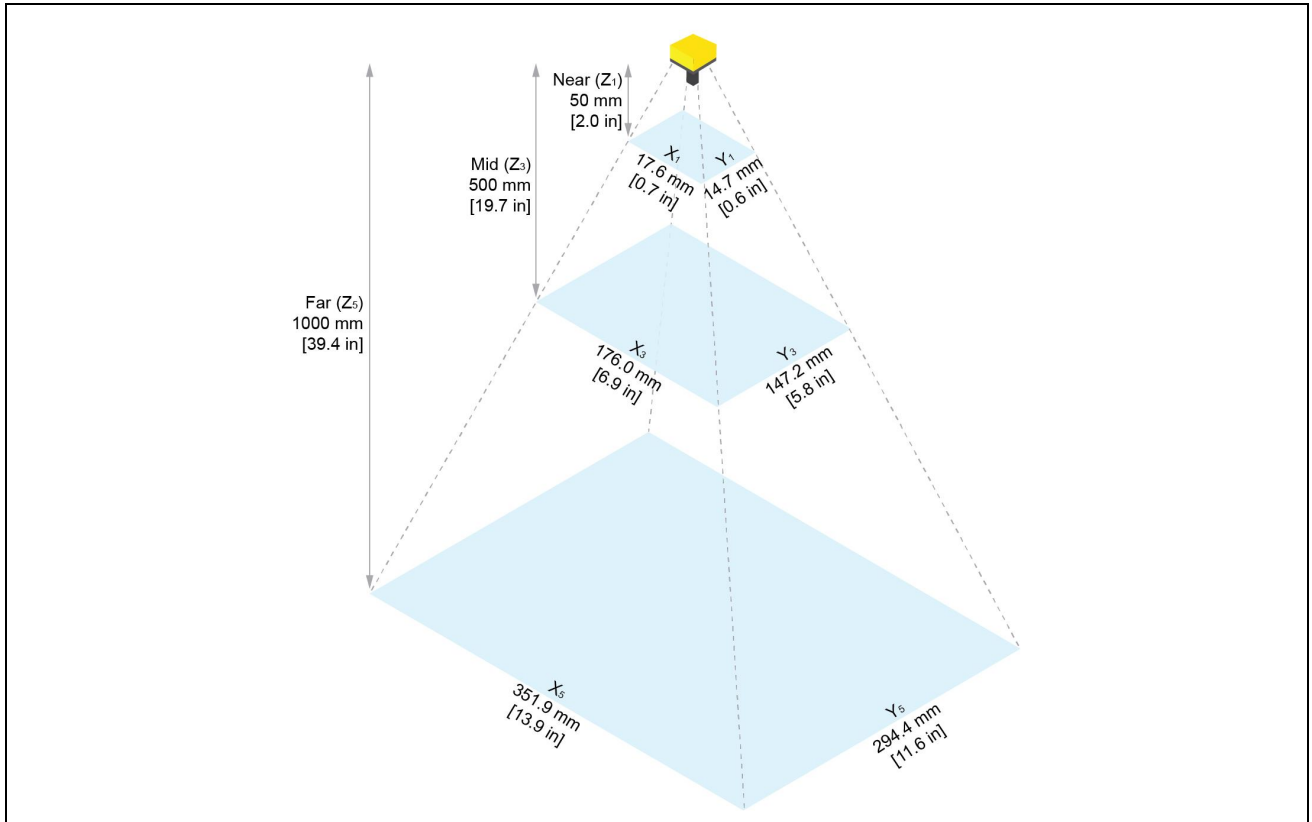

Working Distance	Horizontal Values	Vertical Values
50 mm [2.0 in]	17.76 mm [0.7 in]	14.7 mm [0.6 in]
500 mm [19.7 in]	176.0 mm [6.9 in]	147.2 mm [5.8 in]
1000 mm [39.4 in]	351.9 mm [13.9 in]	294.4 mm [11.6 in]

1D Field of View table with 24 mm Lens:

1D min. code in mil	Distances in mm
4 mil	620 mm
6 mil	915 mm
10 mil	1503 mm
14 mil	2092 mm
20 mil	2976 mm

2D Field of View table with 24 mm Lens:

2D min. code in mil	Distances in mm
4 mil	315 mm
6 mil	456 mm
10 mil	738 mm
14 mil	1020 mm
20 mil	1444 mm

Mounting the Reader

The reader provides mounting holes for attachment to a mounting surface.

CAUTION: You must ground the reader, either by mounting the reader to a fixture that is electrically grounded or by attaching a wire from the mounting fixture on the reader to frame ground or earth ground. If you use a ground wire, attach the wire to one of the four mounting points on the back plate of the reader and not to the mounting points on the front of the reader.

Mounting Bracket (BKT-INS-01)

1. Align the mounting bracket with the mounting holes on the reader. If using the M3 mounting holes, you can attach the mounting bracket in either orientation.
2. Insert the M3 screws into the mounting holes and tighten. The maximum torque is 0.90 Nm (8 in-lb).

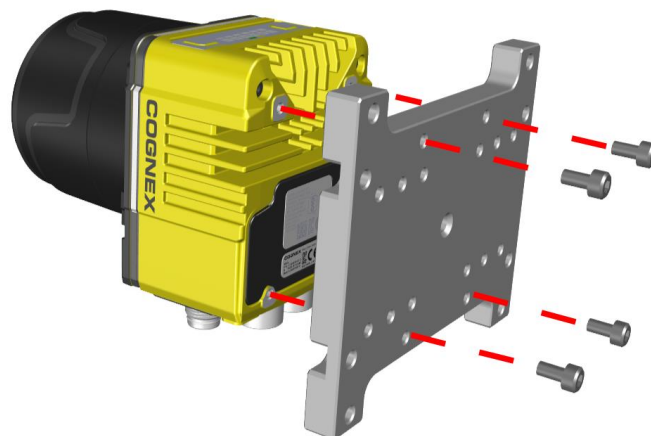
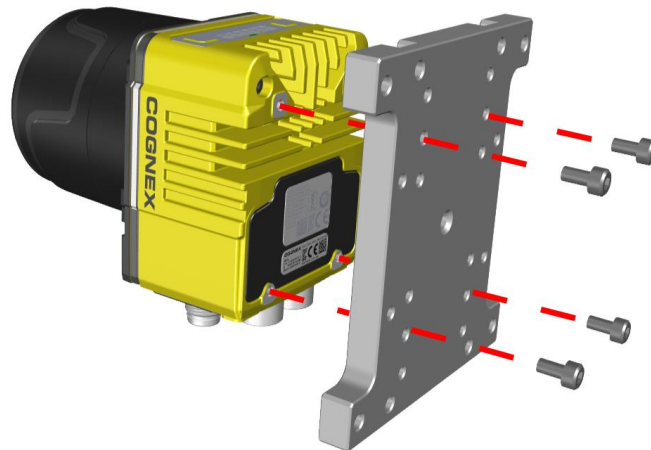

Mounting with Pivot Bracket

1. Align the pivot mounting bracket with the reader.

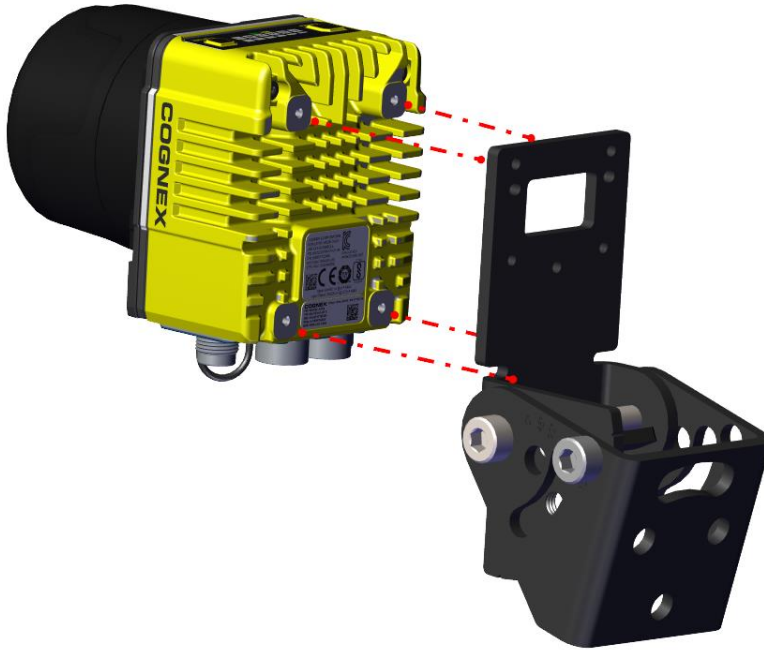

2. Insert the screws into the mounting pilot holes and tighten them.

i Note: Apply a maximum of 0.4 Nm torque when tightening the screws.

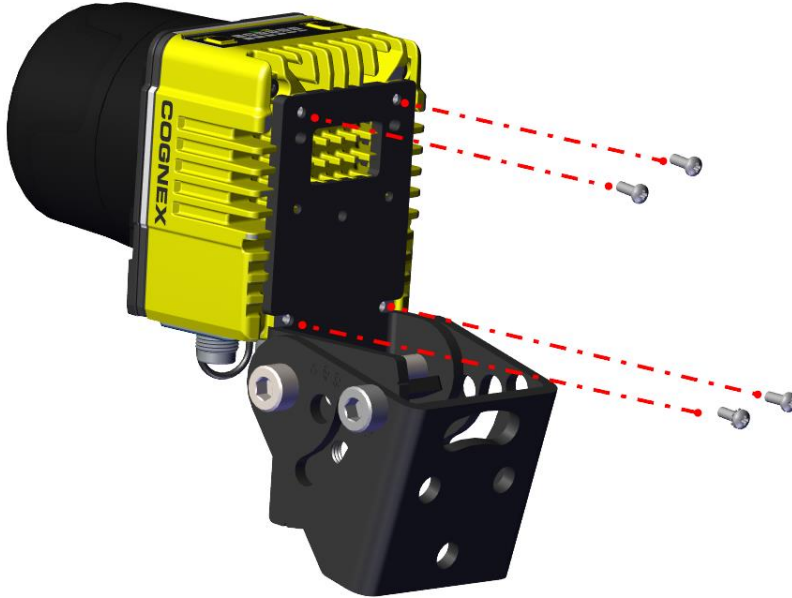

3. Place the reader on a mounting surface and tighten the screws.

Connecting the Ethernet Cable

CAUTION: The Ethernet cable shield must be grounded at the far end. Whatever this cable is plugged into (typically a switch or router) should have a grounded Ethernet connector. A digital voltmeter should be used to validate the grounding. If the far end device is not grounded, a ground wire should be added in compliance with local electrical codes.

1. Connect the M12 connector of the Ethernet cable to the reader ENET connector.

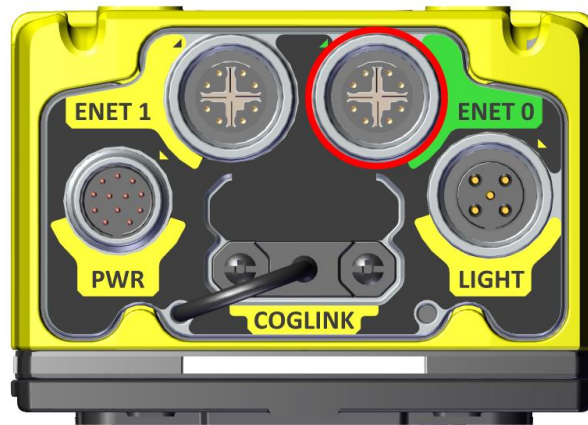

2. Connect the RJ-45 connector of the Ethernet cable to a switch/router or PC, as applicable.

Connecting the Power and I/O Breakout Cable

CAUTION: To reduce emissions, connect the far end of the Breakout cable shield to frame ground.

Note:



- Perform wiring or adjustments to I/O devices when the reader is not receiving power.
- You can clip unused wires short or use a tie made of non-conductive material to tie them back. Keep bare wires separated from the +24 V DC wire.

1. Verify that the 24 V DC power supply is unplugged and not receiving power.
2. Attach the +24 V DC connector of the Power and I/O Breakout cable and Ground wires to the corresponding terminals on the power supply. For more information, see [Specifications on page 45](#).

CAUTION: Never connect voltages other than 24 V DC. Always observe the polarity shown.

3. Attach the M12 connector of the Power and I/O Breakout Cable to the 24 V DC connector of the reader.
4. Restore power to the 24 V DC power supply and turn it on if necessary.

Using Your DataMan Reader

This section provides information on the installation of the DataMan Setup Tool, troubleshooting connection issues, tuning, image filtering, as well as reader training and package detection.

Connect to DataMan WebUI

Connect to the DataMan WebUI using one of the following options:

Web browser

1. Open a web browser.
2. Enter any of the following details:
 - The IP address of your reader.
 - Serial number: found on the label of the reader, followed by `.local`. For example, `1A2436XN005610.local`.
 - MAC address: found on the label of the reader, followed by `.local`. For example, `00D0243BF53C.local`.
 - Host name: the default host name is `DM290` and the first six characters of the MAC address, followed by `.local`. For example, `DM290-00D024.local`.



Station Manager

1. Go to support.cognex.com/en/downloads/edge-intelligence and select Cognex Station Manager.
2. Download the Station Manager installer and follow the on-screen steps.
3. Find and select your reader.

- Click **Connect** and set up.

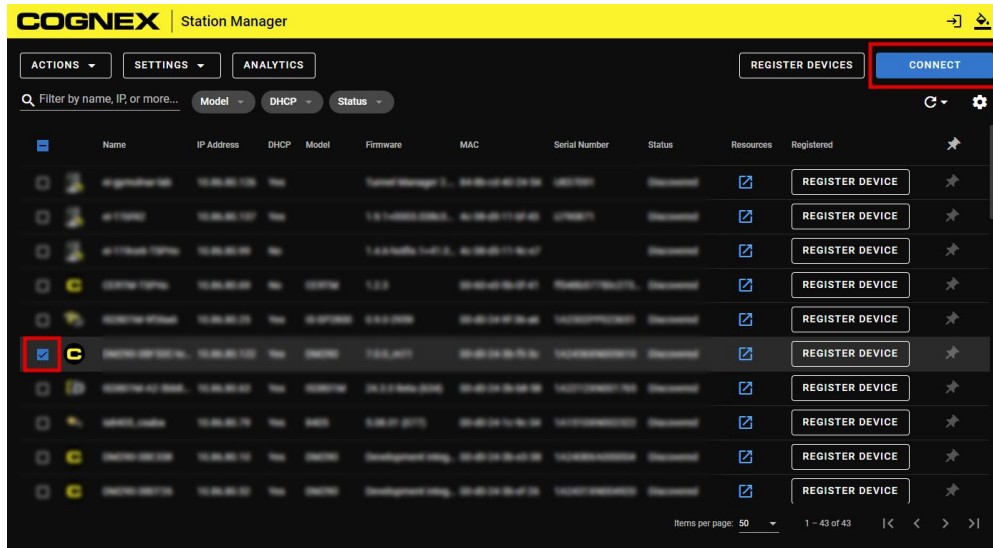

DataMan Setup Tool

- Follow the steps described in [Install DataMan Setup Tool on page 42](#).
- Right-click on your reader and select **Open WebUI In Browser**.

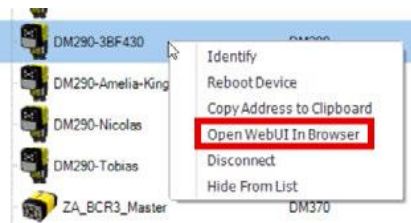

Install DataMan Setup Tool

Follow the steps below to install and connect your reader to the DataMan Setup Tool.

- Check the DataMan **Release Notes** for a full list of system requirements.
- Download the latest version of the DataMan Setup Tool from support.cognex.com/downloads/dataman/software-firmware and follow the on-screen steps.
- Connect the 390 series reader to your PC.
- Launch the DataMan Setup Tool and click **Refresh**. Detected devices appear under **COM ports** or **Network devices**, or both.
- Select a reader from the list and click **Connect**.

Trigger Types

The DataMan 390 readers support the following trigger modes:

- **Self:** At an interval you configure, the reader automatically detects and decodes codes in its field of view. If you set a higher re-read delay than the trigger interval, there is a code output only once until the code is out of the field of view for the duration of the re-read delay.
- **Single (external trigger):** Acquires a single image and attempts to decode any symbol it contains, or more than one symbol in cases where multicode is enabled. The reader relies on an external trigger source.
- **Presentation:** Scans, decodes and reports a single code in the field of view. The reader relies on an internal timing mechanism to acquire images.
- **Manual:** Begins acquiring images when you press the trigger button on the reader, and continues acquiring images until a symbol is found and decoded or you release the button.
- **Burst (external trigger):** Performs multiple image acquisitions based on an external trigger and decodes any symbol appearing in a single image or within a sequence of images, or multiple symbols in a single image or within a sequence of images when multicode is enabled. You can control the number of images within each burst and the interval between image acquisitions.
- **Continuous (external trigger):** Begins acquiring images based on a single external trigger and continues to acquire and decode images until a symbol is found and decoded, or until multiple images containing as many codes as specified in multicode mode are located, or until the trigger is released. You can configure your reader to acquire images based on the start and stop signal from separate digital IO pulses.

External Triggers

If you are using external triggering, you can use any of the following methods to trigger your reader.

- Press the Trigger on the reader.

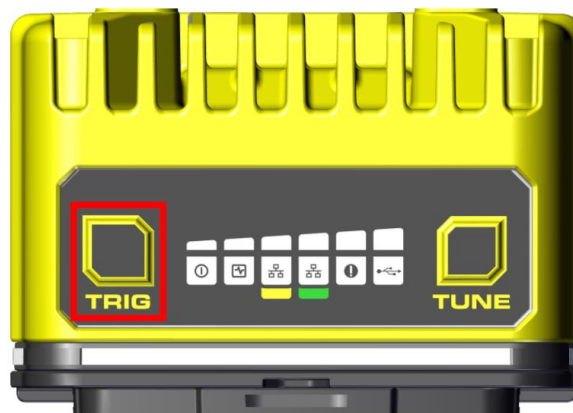

- Send a pulse on the I/O cable.
 - Trigger + (orange or red wire)
 - Trigger - (black wire)
- Send a serial trigger command over the RS-232 connection.
- Press **CTRL+T** on the keyboard while the DataMan Setup Tool has the input focus.
- Click the **Trigger** button in the DataMan Setup Tool.

Industrial Protocols

The reader supports the following industrial protocols:

- EtherNet/IP™
- PROFINET
- SLMP Protocol
- Modbus TCP
- CC-Link IE Field Basic

Select industrial protocol samples and tools you want to use when you install the DataMan Setup Tool.

After enabling the selected industrial protocol, a reboot is required for the changes to take effect. Enable an industrial protocols on the reader with the following options:

- Enable the protocols on the **Communications** substep of the DataMan WebUI.
- Enable the protocols using the **Industrial Protocols** pane of the DataMan Setup Tool, under **Communications**.
- Scan the appropriate **Reader Configuration codes**. For more information, see *Reader Configuration Codes* available through the Windows **Start** menu, the DataMan Setup Tool **Help** menu, or DataMan documentation available on the [Cognex support site](#).
- Send the appropriate **DMCC** command. For more information, see *Command Reference* available through the Windows **Start** menu or the DataMan Setup Tool **Help** menu.

For more information on using the industrial protocols, see the *DataMan Industrial Protocols Manual* available through the Windows **Start** menu, the DataMan Setup Tool **Help** menu, or DataMan documentation available on the [Cognex support site](#).

Specifications

The following sections list general specifications for the reader.

DataMan 390 Series Reader

Specification	DataMan 394X	DataMan 395X
Lens Type	C-Mount lens or High Speed Liquid Lens	
Acquisition (at Full Resolution)	Up to 45 Hz	Up to 33 Hz
Lighting	<p>High Powered Integrated Torch (HPIT): red or white lighting with a distance sensor, laser aimer and configurable indicator lights</p> <p>High Powered Integrated Accessory (HPIA): red, white, blue, or IR lighting</p> <p>Front cover options: polarized and clear</p> <p>Other: various controllable external light options</p>	
Status LEDs	Pass/Fail LED and Indicator Ring, Network LED, and Error LED.	
Discrete Inputs	<p>1 opto-isolated, acquisition trigger input.</p> <p>Up to 3 general-purpose inputs when connected to the Breakout cable</p>	
Discrete Outputs	Up to 4 outputs when connected to the Breakout cable	
Power Output	24 V DC at 1.0 A maximum to external light	
Power Consumption	24 V DC +/- 10%, 2.0 A maximum	
Dimensions	<p>DataMan 390 with no accessories attached: 69 x 89.7 x 45.9 mm (2.72 x 3.53 x 1.81 in)</p> <p>DataMan 390 with HPIT attached: 90.5 x 89.7 x 89.1 mm (3.56 x 3.53 x 3.51 in)</p> <p>DataMan 390 with 45 mm lens cover attached: 69 x 89.7 x 99.7 mm (2.72 x 3.53 x 3.93 in)</p>	
Weight	<p>DataMan 390 with no accessories attached: 569 g (20.1 oz)</p> <p>DataMan 390 with HPIT attached: 762 g (26.9 oz) — no lens included</p> <p>DataMan 390 with 45 mm C-mount cover: 624 g (22 oz) — no lens included</p>	
Operational Temperature	0° C to 40° C (32° F to 122° F)	
Storage Temperature	-20° C to 80° C (-4° F to 176° F)	
Humidity	< 95% non-condensing	
Shock (Shipping and Storage)	IEC 60068-2-27: 18 shocks (3 shocks in each polarity in each (X, Y, Z) axis) at 80 Gs (800 m/s ² at 11 ms, half-sinusoidal) with cables or cable plugs and a 150 gram or lighter lens attached.	
Vibration (Shipping and Storage)	IEC 60068-2-6: vibration test in each of the three main axis for 2 hours at 10 Gs (10 to 500 Hz at 100 m/s ² at 15 mm) with cables or cable plugs and a 150 gram or lighter lens attached.	
Environmental Protection	<p>IP67, altitude: 2000 m, indoor use only, pollution degree II</p> <p>Note: IP67 rating applies only if all blind plugs and cables are attached properly, or the provided connector plug is installed. Make sure that the IP67-rated cover is installed properly.</p>	
Network Communication	2 Ethernet ports	

Specification	DataMan 394X	DataMan 395X
Ethernet	10/100/1000 BaseT with auto MDIX. IEEE 802.3	
RS-232	RxD, TxD according to TIA/EIA-232-F	
Protocols	TCP/IP, PROFINET, Ethernet/IP, ModBus TCP, SLMP, CC-Link IE Field Basic Supports DHCP, static, and link-local IP address and configuration. One port supports TSN networks.	
Protection	IP67	
RoHS Certified	Yes	
Regulations/Conformity	CE, FCC, KCC, TÜV SÜD NRTL, UKCA	

DataMan 390 Series Reader Image Sensor

Specification	DataMan 394	DataMan DM395
Image Sensor	1/1.8 in CMOS, global shutter	2/3 in CMOS, global shutter
Image Sensor Properties	8.99 mm diagonal, 3.45 x 3.45 µm square pixels	11.1 mm diagonal, 3.45 x 3.45 µm square pixels
Image Resolution (pixels)	2048 x 1536	2448 x 2048
Electronic Shutter Speed	25.1 us to 200 000 µs	19.1 us to 200 000 µs

Illumination Options

The following table presents the maximum possible exposure time and duty cycle for different illuminations:

Illumination	Color	Maximum Exposure Time	Maximum Duty Cycle
DataMan 390 with HPIT	RED	6 ms	4%
	RED in high-power mode	0.25 ms	2%
	WHITE	4.5 ms	4%
	WHITE in high-power mode	0.25 ms	2%

LED and Laser Wavelengths

The following table shows LED types and the related peak wavelengths.

Model	LED	Wavelength
DataMan 390 with HPIT	RED	λ dom (typ): 617 nm
	WHITE	Color temperature: 4000K
	ToF	Infrared emitter : 940 nm
	Laser Aimer	Laser radiation: 515 nm
DataMan 390 with HPIA	RED	λ dom (typ): 617 nm
	WHITE	Color Temperature: 6500K
	BLUE	470 nm
	IR	λ centroid (typ): 850 nm

Acquisition Trigger Input

The reader features one acquisition trigger input, which is optically isolated. You can configure the acquisition trigger input to trigger from an NPN (current sinking) or PNP (current sourcing) device.

- To trigger from an NPN type photoelectric sensor or PLC output, connect COMMON IN to +24 VDC and connect IN 0 to the output of the photoelectric sensor. When the output turns ON, it pulls TRIGGER down to 0 VDC, turning the opto-coupler ON.
- To trigger from a PNP photoelectric sensor or PLC output, connect IN 0 to the output of the photoelectric sensor and connect COMMON IN to 0 VDC. When the output turns ON, it pulls TRIGGER up to +24 VDC, turning the opto-coupler ON.

Note: The acquisition input is compliant to IEC 61131-2 Type 1, 2, 3. The current input limit is 2.5 mA. The voltage range is between 12 - 30 V. The maximum input frequency is 500 kHz, and depends on the length of the cable. The 500 kHz is valid with up to 15 meters long Cognex cables.

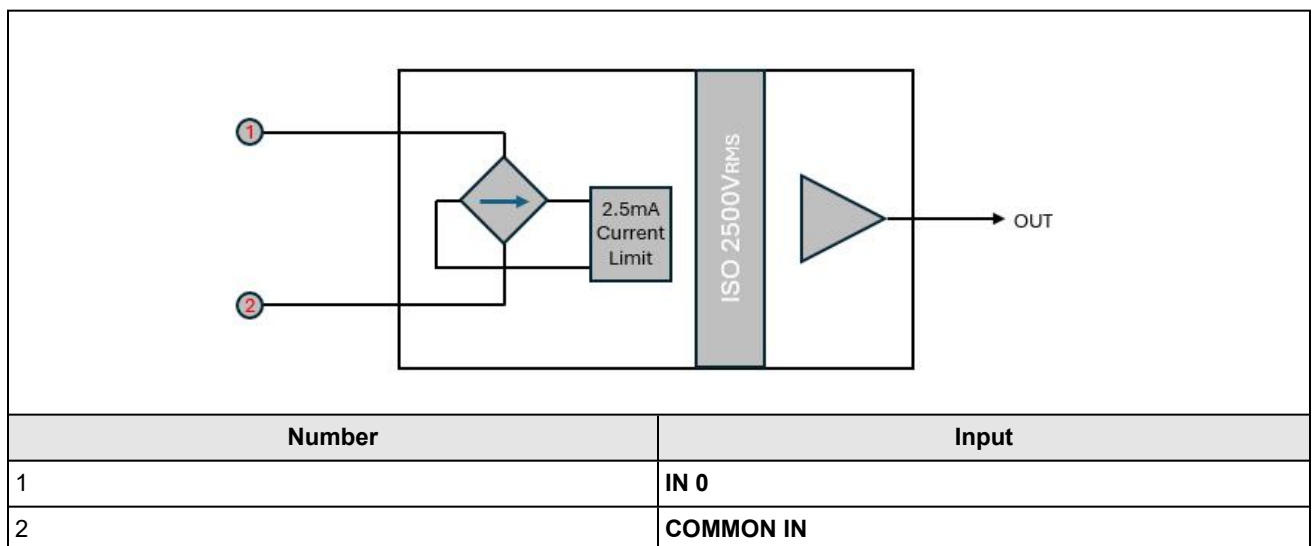

High-Speed Outputs

Specification	Description
Voltage	V_{MAX} : 26 VDC through external load V_{OL} : $\leq \pm 3$ V @ 50 mA
Current	I_{MAX} : 50 mA maximum sink or source current Each line is protected against over-current, short circuits and transients from switching inductive loads. High current inductive loads require an external protection diode.

For NPN lines, the external load must be connected between the output and the positive supply voltage (< 26 VDC). The output pulls down to less than 3 VDC when ON, which causes current to flow through the load. When the output is OFF, no current flows through the load.

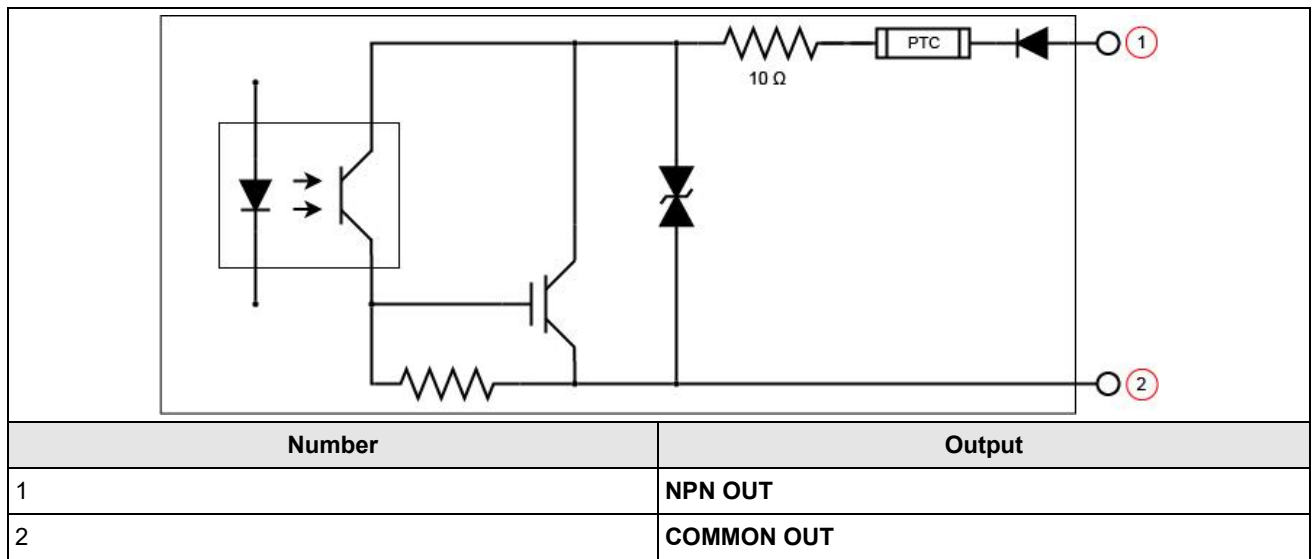

For PNP lines, the external load must be connected between the output and the negative supply voltage (0 VDC). When connected to a 24 VDC power supply, the output pulls up greater than 21 VDC when ON, and current flows through the load. When the output is OFF, no current flows through the load.

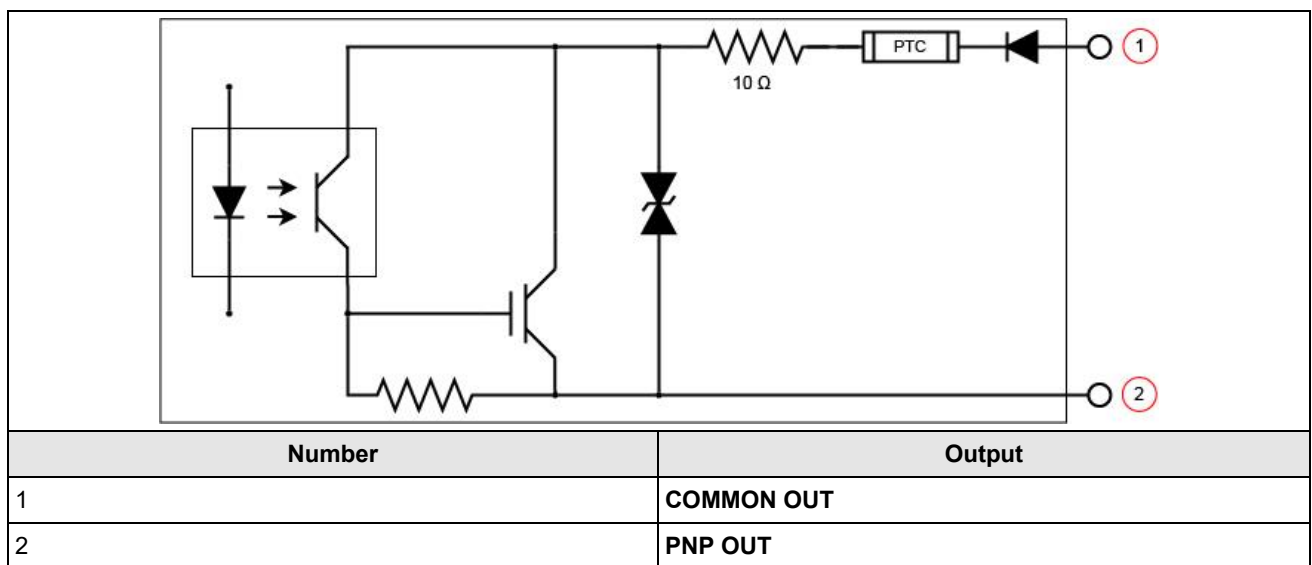

High Speed Output Wiring

To connect to an NPN-compatible PLC input, connect one of the high-speed outputs of the reader directly to the PLC input. When enabled, the output pulls the PLC input down to less than 3 VDC.

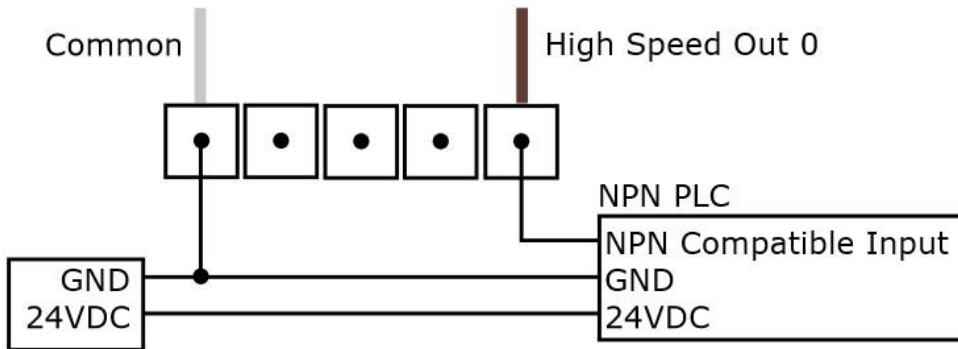

To connect to a PNP-compatible PLC input, connect one of the high-speed outputs of the reader directly to the PLC input. When enabled, the output pulls the PLC input up to greater than 21 VDC.

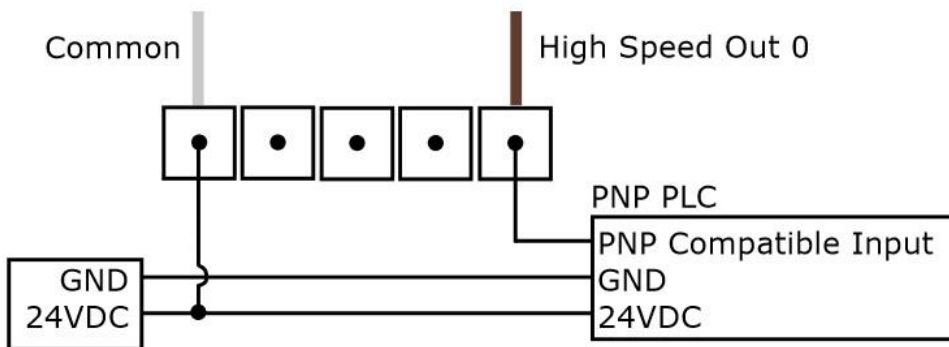

To connect the high-speed outputs to a relay, LED or similar load, connect the negative side of the load to the output and the positive side to +24VDC. When the output switches on, the negative side of the load is pulled down to less than 3 VDC, and 21 VDC appears across the load. Use a protection diode for a large inductive load, with the anode connected to the output and the cathode connected to +24 VDC.

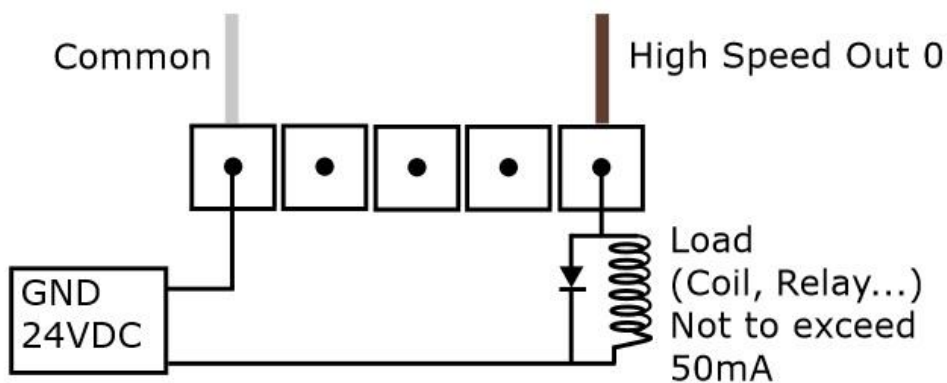

Ethernet Cable

The Ethernet cable provides Ethernet connectivity to the reader. The Ethernet cable is used to connect the reader to other network devices.

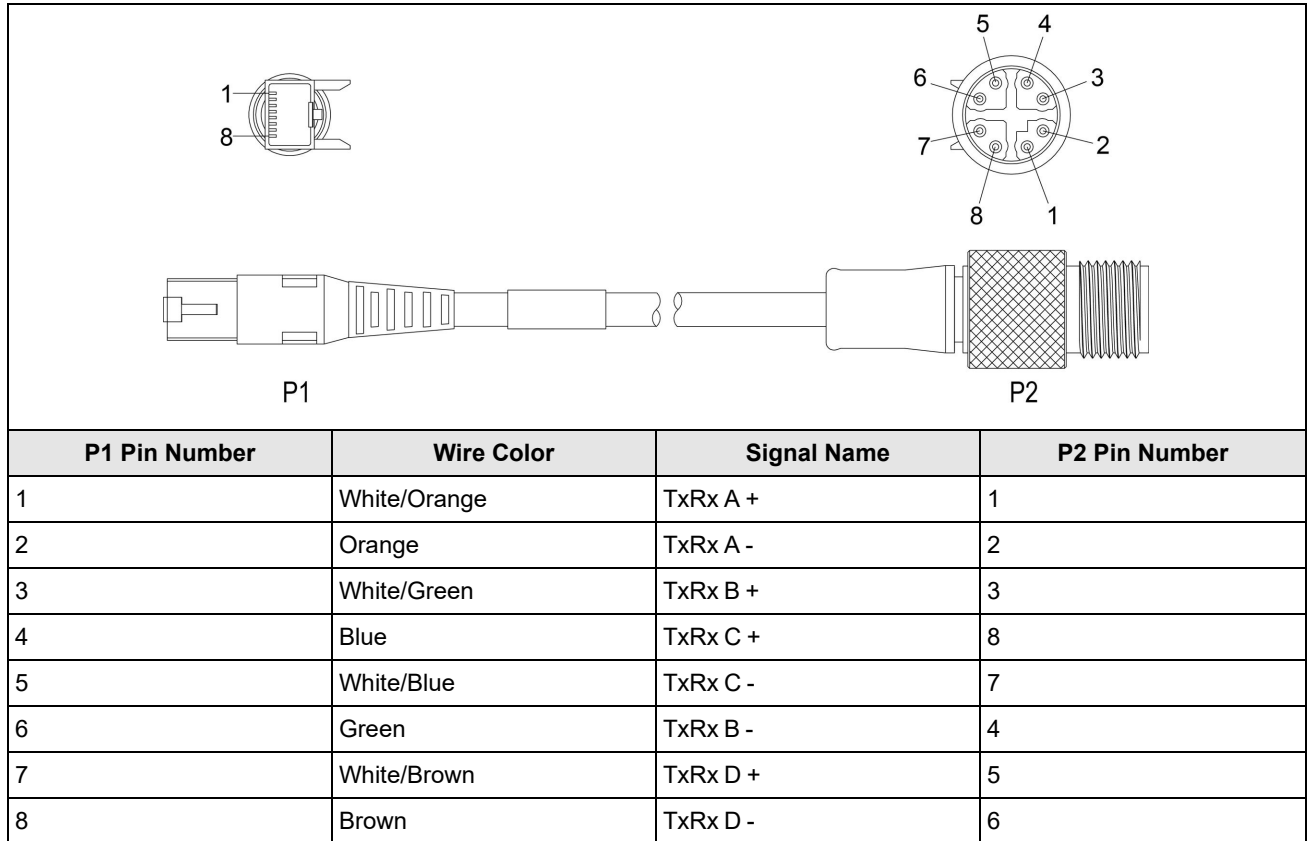

CAUTION: The Ethernet cable shield must be grounded at the far end. Whatever this cable is plugged into (typically a switch or router) should have a grounded Ethernet connector. A digital voltmeter should be used to validate the grounding. If the far end device is not grounded, a ground wire should be added in compliance with local electrical codes.

Note:

- Cables are sold separately.
- The wiring for this cable follows standard industrial Ethernet M12 specifications. It differs from the 568B standard.

Breakout Cable

The Breakout cable provides connections to an external power supply, the acquisition trigger input, general-purpose inputs, high-speed outputs, and RS-232 serial communications. The Breakout cable is not terminated.

The Breakout cable can be connected to devices, such as a trigger sensor or strobe light. The Breakout cable is not terminated.

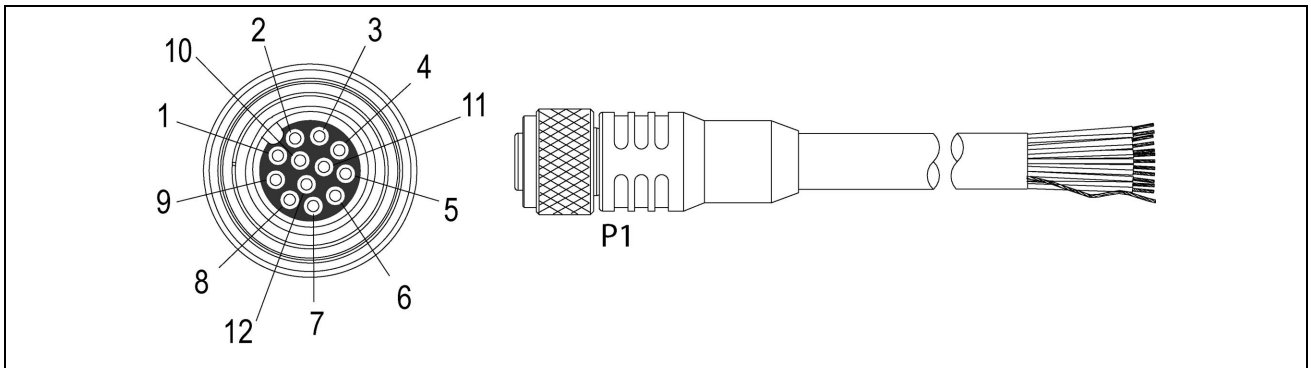

Pin#	Signal Names	Wire Color
1	IN 2 / HSOUT 2	Yellow
2	RS-232 TRANSMIT	White/Yellow
3	RS-232 RECEIVE	Brown
4	IN 3 / HSOUT 3	White/Brown
5	IN 1	Violet
6	COMMON IN	White/Violet
7	+24VDC	Red
8	GND	Black
9	COMMON OUT	Green
10	TRIGGER	Orange
11	HSOUT 0	Blue
12	HSOUT 1	Grey

Note:

- Cables are sold separately.
 - Perform wiring or adjustments to I/O devices when the reader is not receiving power.
- ⓘ
- You can cut exposed wires short or trim wire ends. You also can tie the wires back if you use a tie made of non-conductive material. Keep bare wires separated from the +24 V DC wire.
 - When using the 15 meter Breakout cable, full 24 V DC voltage must be maintained at the input leads of the Breakout cable when the reader is operating.

Power and I/O Breakout Cable (CCB-M12x12Fy-xx)

The Power and I/O Breakout cable provides access to trigger and high-speed outputs. For RS-232, use the Power Supply return path for ground.

The figure on the left shows the plug on the device.

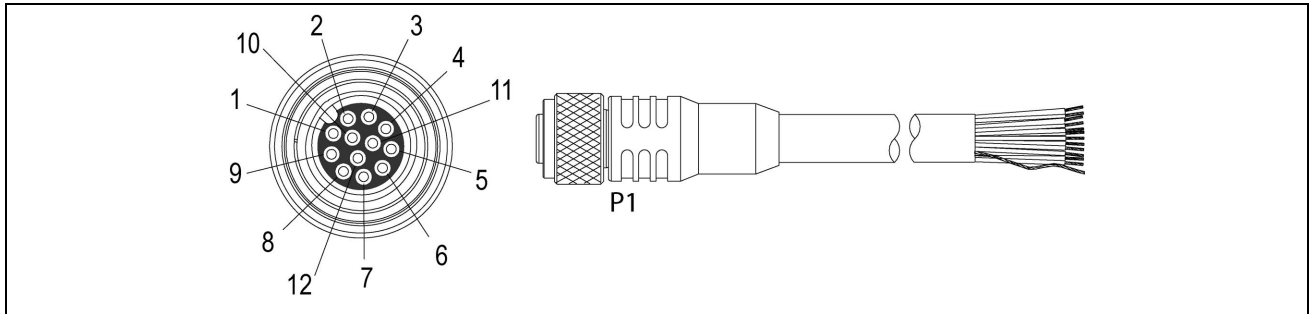

Pin#	Signal Names	Wire Color
1	Out 2/In 2	White
2	TxD	Green
3	RxD	Pink
4	Out 3/In 3	Yellow
5	In 1	Grey
6	Common In	Black
7	+24 VDC	Brown
8	GND	Blue
9	Common Out	Purple
10	In 0	Red
11	Out 0	Grey/Pink
12	Out 1	Red/Blue

Note:

- Cables are sold separately.
- Perform wiring or adjustments to I/O devices when the reader is not receiving power.
- You can cut exposed wires short or trim wire ends. You also can tie the wires back if you use a tie made of non-conductive material. Keep bare wires separated from the +24 V DC wire.



Power and I/O Breakout Cable (CCBL-05-01)

The Power and I/O Breakout cable provides access to trigger and high-speed outputs. For RS-232, use the Power Supply return path for ground.

The figure on the left shows the plug on the device.

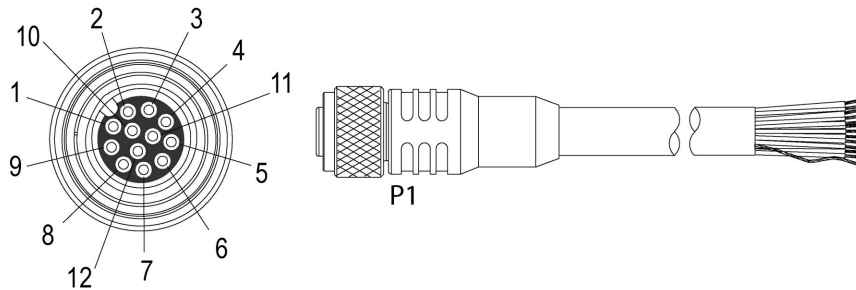

Pin#	Signal Names	Wire Color
1	Out 2/In 2	Yellow
2	TxD	White/Yellow
3	RxD	Brown
4	Out 3/In 3	White/Brown
5	In 1	Violet
6	Common In	White/Violet
7	+24 VDC	Red
8	GND	Black
9	Common Out	Green
10	In 0	Orange
11	Out 0	Blue
12	Out 1	Grey

Note:

- Cables are sold separately.
- Perform wiring or adjustments to I/O devices when the reader is not receiving power.
- You can cut exposed wires short or trim wire ends. You also can tie the wires back if you use a tie made of non-conductive material. Keep bare wires separated from the +24 V DC wire.

Power and I/O Breakout Cable (CCB-PWRIO-xx)

The Power and I/O Breakout cable provides access to trigger and high-speed outputs. For RS-232, use the Power Supply return path for ground.

The figure on the left shows the plug on the device.

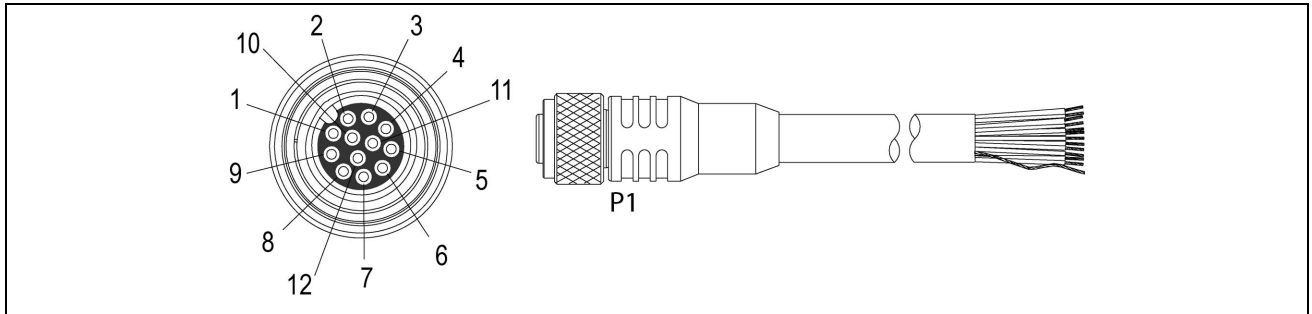

Pin#	Signal Names	Wire Color
1	Out 2/In 2	Yellow
2	TxD	White/Yellow
3	RxD	Brown
4	Out 3/In 3	White/Brown
5	In 1	Violet
6	Common In	White/Violet
7	+24 VDC	Red
8	GND	Black
9	Common Out	Green
10	In 0	Orange
11	Out 0	Blue
12	Out 1	Grey

Note:

- Cables are sold separately.
- Perform wiring or adjustments to I/O devices when the reader is not receiving power.
- You can cut exposed wires short or trim wire ends. You also can tie the wires back if you use a tie made of non-conductive material. Keep bare wires separated from the +24 V DC wire.

Cleaning and Maintenance

Clean the Housing

To clean the outside of the reader housing, use a small amount of mild detergent cleaner or isopropyl alcohol on a cleaning cloth. Do not pour the cleaner on the reader housing.

 **CAUTION:** Do not attempt to clean any DataMan product with harsh or corrosive solvents, including lye, methyl ethyl ketone (MEK) or gasoline.

Clean the Reader Image Sensor Window

To remove dust from the outside of the image sensor window, use a pressurized air duster. The air must be free of oil, moisture or other contaminants that could remain on the glass and possibly degrade the image. Do not touch the glass window. If oil or smudges remain, use a cotton bud and alcohol (ethyl, methyl, or isopropyl) to clean the window. Do not pour the alcohol on the window.



Clean the Reader Lens Cover

To remove dust from the lens cover, use a pressurized air duster. The air must be free of oil, moisture or other contaminants that could remain on the lens cover. To clean the plastic window of the lens cover, use a small amount of isopropyl alcohol on a cleaning cloth. Do not scratch the plastic window. Do not pour the alcohol on the plastic window.

Regulations and Conformity

Note: For the most current CE and UKCA declaration and regulatory conformity information, see the Cognex support site: cognex.com/support.

The DataMan 390 reader has the Regulatory Model 50103 and meets or exceeds the requirements of all applicable standards organizations for safe operation. However, as with any electrical equipment, the best way to ensure safe operation is to operate them according to the agency guidelines that follow. Please read these guidelines carefully before using your reader.

Safety and Regulatory	
Manufacturer	Cognex Corporation One Vision Drive Natick, MA 01760 USA
	Model Name: Regulatory Model 50103 This is a class A product. In a domestic environment this product may cause radio interference in which case the user may be required to take immediate measures. This equipment complies with the essential requirements of the EU Directive 2014/30/EU. Declarations are available from your local representative.
EU RoHS	Compliant to the most recent applicable directive.
FCC	FCC Part 15, Class A This equipment has been tested and found to comply with the limits for a Class A digital device, pursuant to part 15 of the FCC Rules. These limits are designed to provide reasonable protection against harmful interference when the equipment is operated in a commercial environment. This equipment generates, uses, and can radiate radio frequency energy and, if not installed and used in accordance with the instruction manual, may cause harmful interference to radio communications. Operation of this equipment in a residential area is likely to cause harmful interference in which case the user will be required to correct the interference at his own expense.
Korea 	R-R-CGX-50103 This device is certified for office use only and if used at home, there can be frequency interference problems.
TÜV	Regulatory Model 50103 NRTL: TÜV SÜD SCC/NRTL OSHA Scheme for UL/CAN 61010-1. CB report available upon request. TÜV SÜD, IEC/EN 61010-1.
	Regulatory Model 50103 This is a class A product. In a domestic environment this product may cause radio interference in which case the user may be required to take immediate measures. This equipment complies with the essential requirements of the Electromagnetic Compatibility Regulations 2016. Declarations are available from your local representative.

中国大陆RoHS (Information for China RoHS Compliance)

根据中国大陆《电子信息产品污染控制管理办法》(也称为中国大陆RoHS), 以下部份列出了本产品中可能包含的有毒有害物质或元素的名称和含量。



	Hazardous Substances 有害物质					
Part Name 部件名称	Lead (Pb) 铅	Mercury (Hg) 汞	Cadmium (Cd) 镉	Hexavalent Chromium (Cr (VI)) 六价铬	Polybrominated biphenyls (PBB) 多溴联苯	Polybrominated diphenyl ethers (PBDE) 多溴二苯醚
Regulatory Model 50103	X	O	O	O	O	O

This table is prepared in accordance with the provisions of SJ/T 11364.
这个标签是根据SJ/T 11364 的规定准备的。

O: Indicates that said hazardous substance contained in all of the homogeneous materials for this part is below the limit requirement of GB / T26572 - 2011.
表示本部件所有均质材料中含有的有害物质低于GB / T26572 - 2011 的限量要求。

X: Indicates that said hazardous substance contained in at least one of the homogeneous materials used for this part is above the limit requirement of GB / T26572 - 2011.
表示用于本部件的至少一种均质材料中所含的危害物质超过GB / T26572 - 2011 的限制要求。

For European Community Users

Cognex complies with Directive 2012/19/EU OF THE EUROPEAN PARLIAMENT AND OF THE COUNCIL of 4 July 2012 on waste electrical and electronic equipment (WEEE).

This product has required the extraction and use of natural resources for its production. It may contain hazardous substances that could impact health and the environment, if not properly disposed.

In order to avoid the dissemination of those substances in our environment and to diminish the pressure on the natural resources, we encourage you to use the appropriate take-back systems for product disposal. Those systems will reuse or recycle most of the materials of the product you are disposing in a sound way.



The crossed out wheeled bin symbol informs you that the product should not be disposed of along with municipal waste and invites you to use the appropriate separate take-back systems for product disposal.

If you need more information on the collection, reuse, and recycling systems, please contact your local or regional waste administration.

You may also contact your supplier for more information on the environmental performance of this product.

