

DataMan[®] 8072 Verifier Reference Manual



2025 April 14
Revision: 25.2.0.13

Legal Notices

The software described in this document is furnished under license, and may be used or copied only in accordance with the terms of such license and with the inclusion of the copyright notice shown on this page. Neither the software, this document, nor any copies thereof may be provided to, or otherwise made available to, anyone other than the licensee. Title to, and ownership of, this software remains with Cognex Corporation or its licensor. Cognex Corporation assumes no responsibility for the use or reliability of its software on equipment that is not supplied by Cognex Corporation. Cognex Corporation makes no warranties, either express or implied, regarding the described software, its merchantability, non-infringement or its fitness for any particular purpose.

The information in this document is subject to change without notice and should not be construed as a commitment by Cognex Corporation. Cognex Corporation is not responsible for any errors that may be present in either this document or the associated software.

Companies, names, and data used in examples herein are fictitious unless otherwise noted. No part of this document may be reproduced or transmitted in any form or by any means, electronic or mechanical, for any purpose, nor transferred to any other media or language without the written permission of Cognex Corporation.

Copyright © 2025. Cognex Corporation. All Rights Reserved.

Portions of the hardware and software provided by Cognex may be covered by one or more U.S. and foreign patents, as well as pending U.S. and foreign patents listed on the Cognex web site at: cognex.com/patents.

The following are registered trademarks of Cognex Corporation:

Cognex, 2DMAX, Advantage, AlignPlus, Assemblyplus, Check it with Checker, Checker, Cognex Vision for Industry, Cognex VSOC, CVL, DataMan, DisplayInspect, DVT, EasyBuilder, Hotbars, IDMax, In-Sight, Laser Killer, MVS-8000, OmniView, PatFind, PatFlex, PatInspect, PatMax, PatQuick, SensorView, SmartView, SmartAdvisor, SmartLearn, UltraLight, Vision Solutions, VisionPro, VisionView

The following are trademarks of Cognex Corporation:

The Cognex logo, 1DMax, 3D-Locate, 3DMax, BGAll, CheckPoint, Cognex VSoC, CVC-1000, FFD, iLearn, In-Sight (design insignia with cross-hairs), In-Sight 2000, InspectEdge, Inspection Designer, MVS, NotchMax, OCRMax, PatMax RedLine, ProofRead, SmartSync, ProfilePlus, SmartDisplay, SmartSystem, SMD4, VisiFlex, Xpand

Portions copyright © Microsoft Corporation. All rights reserved.

Portions copyright © MadCap Software, Inc. All rights reserved.

Other product and company trademarks identified herein are the trademarks of their respective owners.

Table of Contents

Legal Notices	2
Table of Contents	3
Symbols	5
Getting Started	6
About DataMan 8072 Verifier	6
DataMan 8072 Verifier Kits	6
DataMan 8072 Verifier Accessories	9
Cables	10
Physical Layout of the DataMan 8072 Verifier	10
Setting Up the Verifier	12
Install the DataMan SetupTool and Connect to Verifier	16
DataMan 8072 Verifier Specifications	16
DataMan 8072 Verifier Imager Specifications	16
LED Wavelengths for DataMan 8072 Verifier	16
Calibration	17
Using Your DataMan 8072V Verifier	21
Verifying a 2D Barcode	21
Selecting Regions	23
Examining the Results	23
Main	23
General Characteristics	24
Data Detail	25
Quality Detail	25
Advanced Detail	26
Histogram	26
Report	28
User Interface	30
Toolbar	30
Adjusting the Focus Height	30
Illumination Icons	31
Settings	33
Accessing the Settings Menu	33
Application Settings	33
Application Standards Settings	35
Pre-defined Application Standards	36
Custom Application Standard	39
Calibration Settings	42
User Information	43
Report Settings	44
Navigation	45
Result through Setup Tool (Local Machine)	46
Results through FTP	48

Cleaning/Maintenance	52
Cleaning the Verifier Housing	52
Cleaning the Verifier Lens Cover	52
Regulations and Conformity	53
中国大陆RoHS (Information for China RoHS Compliance)	54
Precautions	55

Symbols

The following symbols indicate safety precautions and supplemental information:

 **WARNING:** This symbol indicates a hazard that could cause death, serious personal injury or electrical shock.

 **CAUTION:** This symbol indicates a hazard that could result in property damage.

 **Note:** This symbol indicates additional information about a subject.

 **Tip:** This symbol indicates suggestions and shortcuts that might not otherwise be apparent.

Getting Started

About DataMan 8072 Verifier



The DataMan 8072 Verifier is designed to change the direct part mark (DPM) barcode verification experience. The versatile DM8072V is packed with powerful lighting options, a fast processing engine, and a high-resolution camera to capture and grade even the most difficult DPM barcodes up to four times quicker than other verifiers on the market. As the only DPM verifier with 30, 45 and 90-degree lighting options, the DM8072V can easily illuminate codes on textured, curved, and even recessed surfaces. Grade Data Matrix and QR codes against ISO and application standards with easy-to-read results displayed on the DataMan Setup Tool software. The all-new user interface provides more detailed reporting and diagnostic capabilities than ever before.

The DataMan 8072 Verifiers are available with the following communication options:

- Ethernet
- USB

The DataMan 8072 Verifiers provide the following features:

- Accurate barcode verification according to ISO global standards
- 2D Imager with integrated illumination
- Repeatable and accurate results
- Calibrated and traceable to NIST standards
- Easy-to-use software interface
- Detailed reporting
- Export of verification results in Adobe PDF™
- Consistent results independent of operator training or skill
- Adjustable height stand with Focus Indicator (available as an option)

DataMan 8072 Verifier Kits

The DataMan 8072 Verifier is available in the following kits:

Model number	Description
--------------	-------------

DMV-8072V-S-0200U (USA power adapter) DMV-8072V-S-0200E (EU power adapter)	DataMan 8072 Verifier Ethernet Kit with Stand: <ul style="list-style-type: none"> • DataMan 8072 Verifier • Standoff • Ethernet Slide-In • Ethernet Cable Attachment • Standard Ethernet Cable • POE Injector • Basic Calibration Card • Stand Accessory
DMV-8072V-S-0100	DataMan 8072 Verifier USB Kit with Stand: <ul style="list-style-type: none"> • DataMan 8072 Verifier • Standoff • USB Slide-In • USB Cable • Power Supply • Basic Calibration Card • Stand Accessory
DMV-8072V-0200 (USA power adapter) DMV-8072V-0200-EU (EU power adapter)	DataMan 8072 Verifier Ethernet Kit: <ul style="list-style-type: none"> • DataMan 8072 Verifier • Standoff • Ethernet Slide-In • Ethernet Cable Attachment • POE Injector • Basic Calibration Card
DMV-8072V-0100	DataMan 8072 Verifier USB Kit <ul style="list-style-type: none"> • DataMan 8072 Verifier • Standoff • USB Slide-In • USB Cable • Power Supply • Basic Calibration Card
DMV-8072V-0000	DataMan 8072 Verifier Kit <i>No Slide-In</i> <ul style="list-style-type: none"> • DataMan 8072 Verifier • Standoff • Basic Calibration Card

DMV-8072VHD-0100	<p>DataMan 8072 Verifier Kit <i>No Slide-In</i></p> <ul style="list-style-type: none"> • DataMan 8072 Verifier-HD • Standoff • USB Slide-in • USB Cable • Power Supply • Basic Calibration Card • Stand Accessory
<p>DMV-8072VHD-02 (USA power adapter) DMV-8072VHD-02EU (EU power adapter)</p>	<p>DataMan 8072 Verifier-HD Ethernet Kit:</p> <ul style="list-style-type: none"> • DataMan 8072 Verifier-HD • Standoff • Ethernet Slide-in • Ethernet Cable Attachment • POE Injector • Basic Calibration Card
DMV-8072VHD-S-01	<p>DataMan 8072 Verifier-HD USB Kit with Stand:</p> <ul style="list-style-type: none"> • DataMan 8072 Verifier-HD S-model • Standoff • USB Slide-in • USB Cable • Power Supply • Basic Calibration Card • Stand Accessory
<p>DMV-8072VHD-02U (USA power adapter) DMV-8072VHD-02E (EU power adapter)</p>	<p>DataMan 8072 Verifier-HD Verifier Ethernet Kit with Stand:</p> <ul style="list-style-type: none"> • DataMan 8072 Verifier-HD S-model • Standoff • Ethernet Slide-in • Ethernet Cable Attachment • Standard Ethernet Cable • POE Injector • Basic Calibration Card • Stand Accessory

DataMan 8072V Verifier and stand-off



Ethernet or USB slide-in



Stand accessory





Calibration Cards



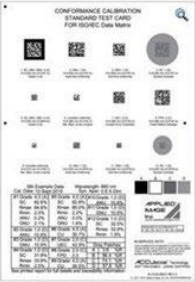

DataMan 8072 Verifier Accessories

Ethernet slide-in	DMCM-ENETM-00	
Serial/USB 2.0 slide-in	DMCM-USB2EN-00	
Power Supply for USB 2.0 slide-in	DM100-PWR-000	
POE hub	CPS-AC-POE1A-US	
Stand accessory	DMV-8072V-STAND	
Stand-off/Nose Cone for 8072V/HD	DMV-8072V-SO-0200	

Cognex Basic Calibration Card	DMV-CCC	
Applied Image Conformance Calibration Card	DMV-DMCC	
Validation Protocols for DM8072V	DMV-VP-8072V	

Cables

USB cable for USB 2.0 slide-in, 2.5 m	DM8500-USBC-02	
Ethernet cable for Ethernet slide-in, 5 m	DM8000-ECABLEC-05	
Standard Ethernet cable	CBL-C10E	

Physical Layout of the DataMan 8072 Verifier

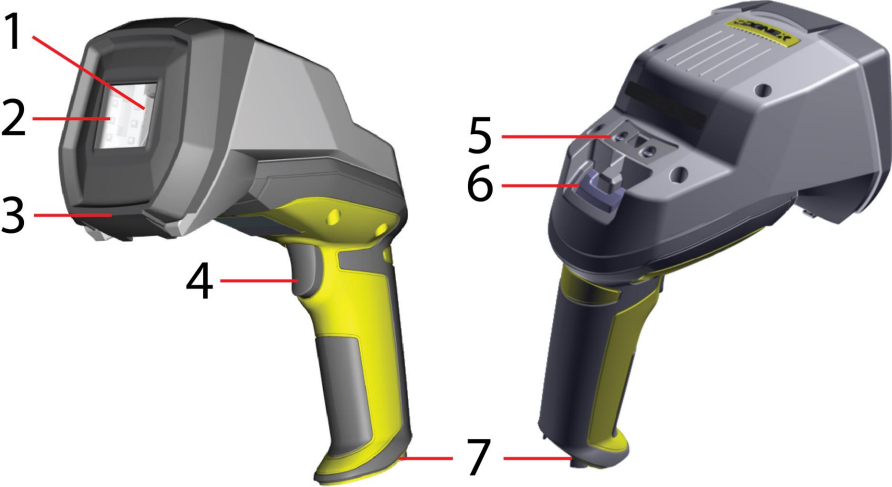
	
	
1	Imager and Lens Optical System
2	Illumination
3	Removable Standoff

4	Trigger (press and release)
5	Lanyard hook
6	Indicator light
7	Communication module insertion point

Status indicator Light:

- Communication:
 - GREEN = good verification
 - RED = bad verification

i Note: For more information on the DataMan 8072V hardware, see the *DataMan 8072 Verifier Quick Reference Guide*.

Setting Up the Verifier

To connect to the verifier or base station on your computer:

1. Select the connection type: Ethernet, or USB, and connect the cables respectively.



Ethernet



USB

2. Turn on your device(s).
3. Open the DataMan Setup Tool and connect to your DataMan 8072 Verifier. The TruCheck verification application automatically opens after the unit is successfully connected.

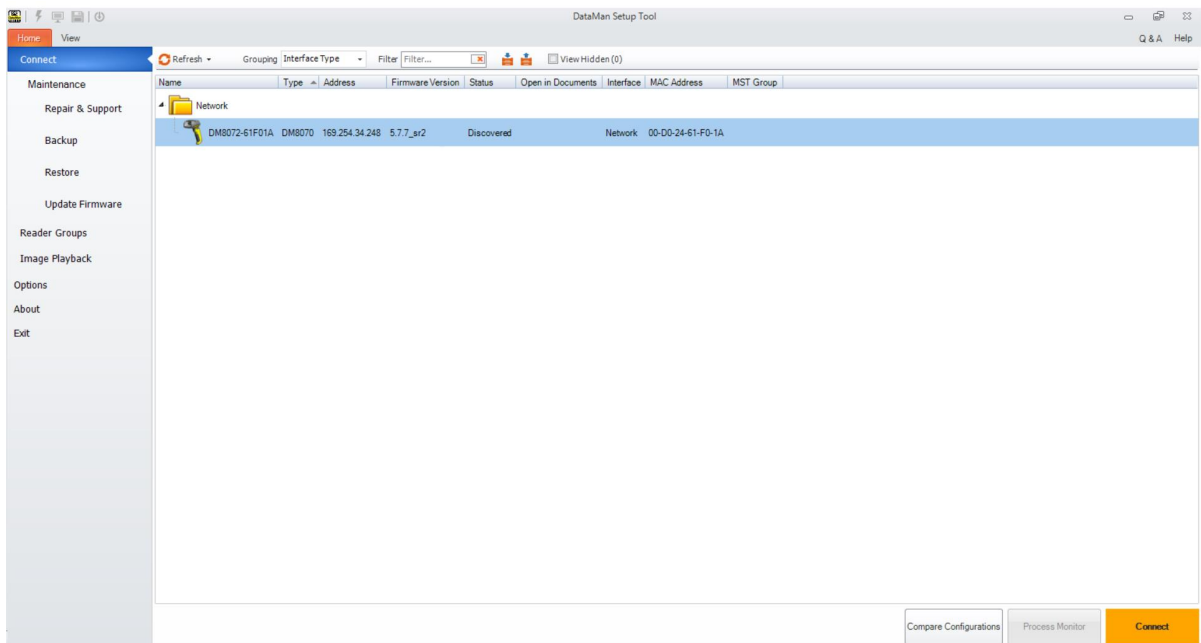

Tip: If the TruCheck verification window does not automatically open, or is closed during use, it can be re-opened by selecting the **View** tab in the DataMan Setup Tool and selecting the **TruCheck Window** icon.

For some computers, connecting to a verifier using a USB 2.0 slide-in requires additional steps. Some Windows PCs have USB selective suspend enabled by default and you have to disable the USB selective suspend for the USB interface to work correctly. To disable USB selective suspend, follow these steps to correct the problem:

1. Select the **Start** button in the bottom left corner of your computer and select the **Settings** icon.



2. Select **System**, then select **Power & sleep**.
3. In the **Power & sleep** menu, select **Additional Power Settings**. You can find this option on the right side of the window under **Related Settings**. This opens the **Power Options** menu.

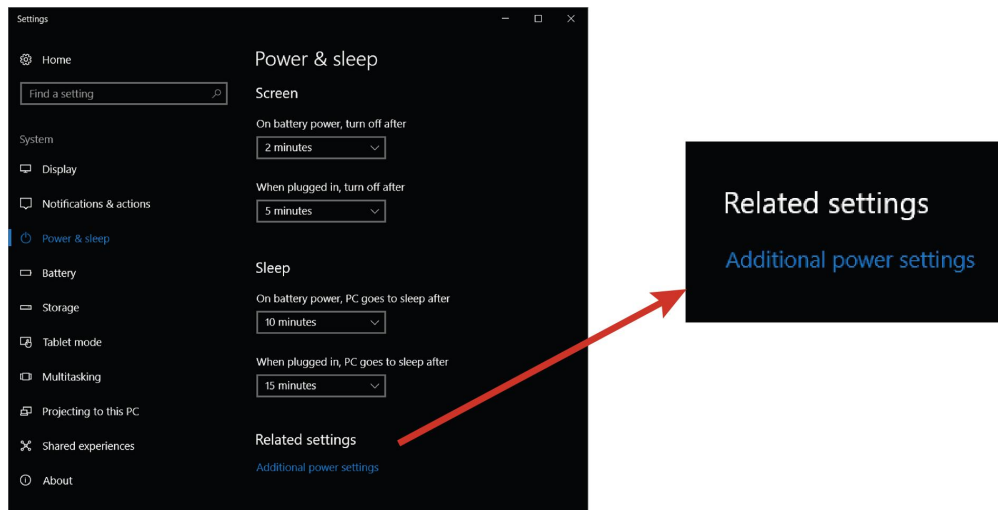

- In the **Power Options** menu, select **Change plan settings** on the power plan that is currently selected. The **Edit Plan Settings** menu opens.

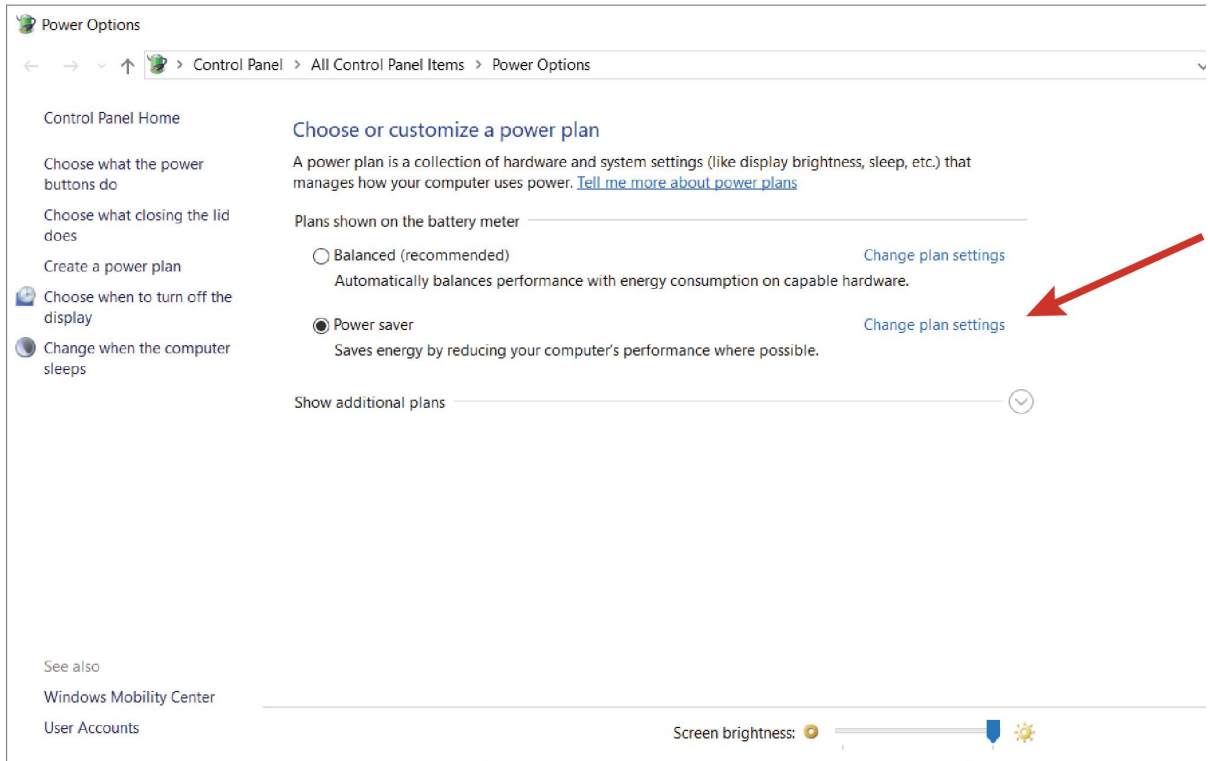

- In the **Edit Plan Settings** menu, select **Change advanced power settings**. The **Power Options** menu opens.

6. In the **Advanced settings** tab under the **Power Options** menu, locate USB Settings. Select **[+]** for both **USB Settings** and **USB selective suspend setting**. Under this selection, there are options for **On Battery** and **Plugged In**. Set both to **Disabled** by selecting from the drop-down menu.

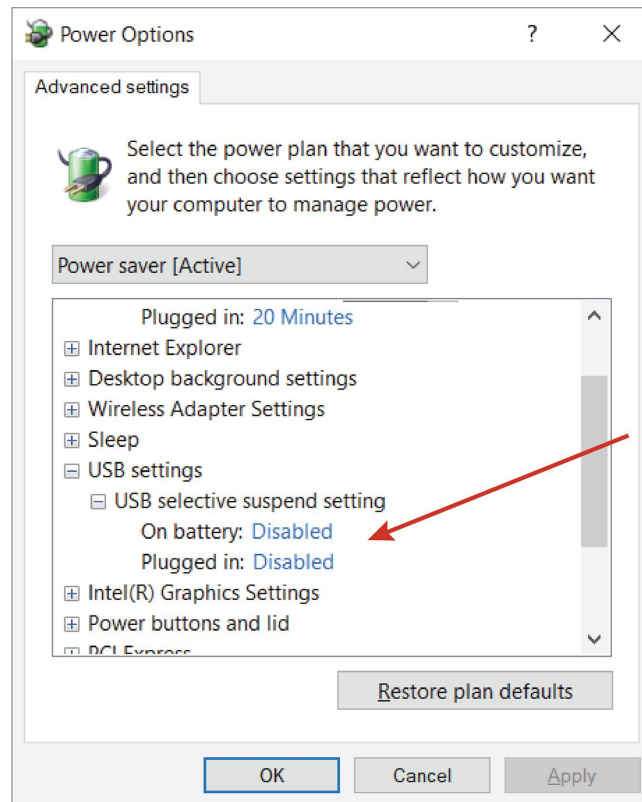

7. Click **OK** and restart your computer.
8. Open the DataMan Setup Tool and plug in the USB 2.0 slide-in. The DM8072V now appears in the device list.
9. If the DM8072V does not appear in the device list, go to *Start- > Devices and Printers -> LAN7500 [right-click] -> Troubleshoot* and see if that fixes the problem.
10. If you still do not see the DM8072V in the device list, open a web browser and search for "LAN 7500 USB to Ethernet Adaptor for windows X" (X means Windows 7 or Windows 10 or latest edition you use) and download it. Reboot the and try again.

Install the DataMan SetupTool and Connect to Verifier

1. Check the DataMan **Release Notes** for a full list of system requirements.
2. Download the DataMan Setup Tool from cognex.com/support/dataman and follow the on-screen steps.
3. Connect the DM8072V to your PC.
4. Launch the DataMan Setup Tool and click **Refresh**. The verifier appears under **COM ports** or **Network devices**.
5. Select your DM8072V from the list and click **Connect**.

Note: Make sure that Adobe Acrobat Reader is installed to view the Report tab in the TruCheck window. If you do not have Adobe Acrobat Reader installed, you can still save reports as PDFs.

DataMan 8072 Verifier Specifications

Weight	400 g (including grip assembly with battery)
Operating Temperature	0°C — 45°C (32°F — 113°F)
Storage Temperature	0°C — 60°C (32°F — 140°F)
Maximum Humidity	95% (non-condensing)
Environmental	IP65
Codes	2-D barcodes: Data Matrix™ (IDMax and IDQuick: ECC200), QR Code
Power Supply Requirements	USB: bus powered (optionally: external 6W max LPS or NEC class 2 power supply +5V - +6V DC) ETH: Class 2 PoE supply IEEE 802.3af (connect only to PoE networks without routing to the outside plant)
Inrush current peak	5A maximum Duration: approx. 30µs
Ethernet	10/100 Base-T FULL/HALF DUPLEX, IEEE 802.3

DataMan 8072 Verifier Imager Specifications

Specification	DataMan 8072 Verifier Imager
Image Sensor	1/3 inch CMOS global shutter
Image Sensor Properties	3.75 µm square pixels
Image Resolution (Pixels)	1280 x 966
Lens Type	12 mm F:4 S-mount lens

LED Wavelengths for DataMan 8072 Verifier

Note: The data below refer to the LED illumination accessory of the reader, not to the LED indicators.

The following table shows LED types and the related wavelengths:

LED	λ [nm]
RED	660

Calibration

Before starting to use the DataMan 8072 Verifier for verifying barcodes, you need to calibrate the device. Perform the following steps to calibrate the unit.

1. In the TruCheck Verification window, click the **Calibration** icon in the top left corner.



2. Enter the **Rmax** and **Rmin** values from the calibration card.

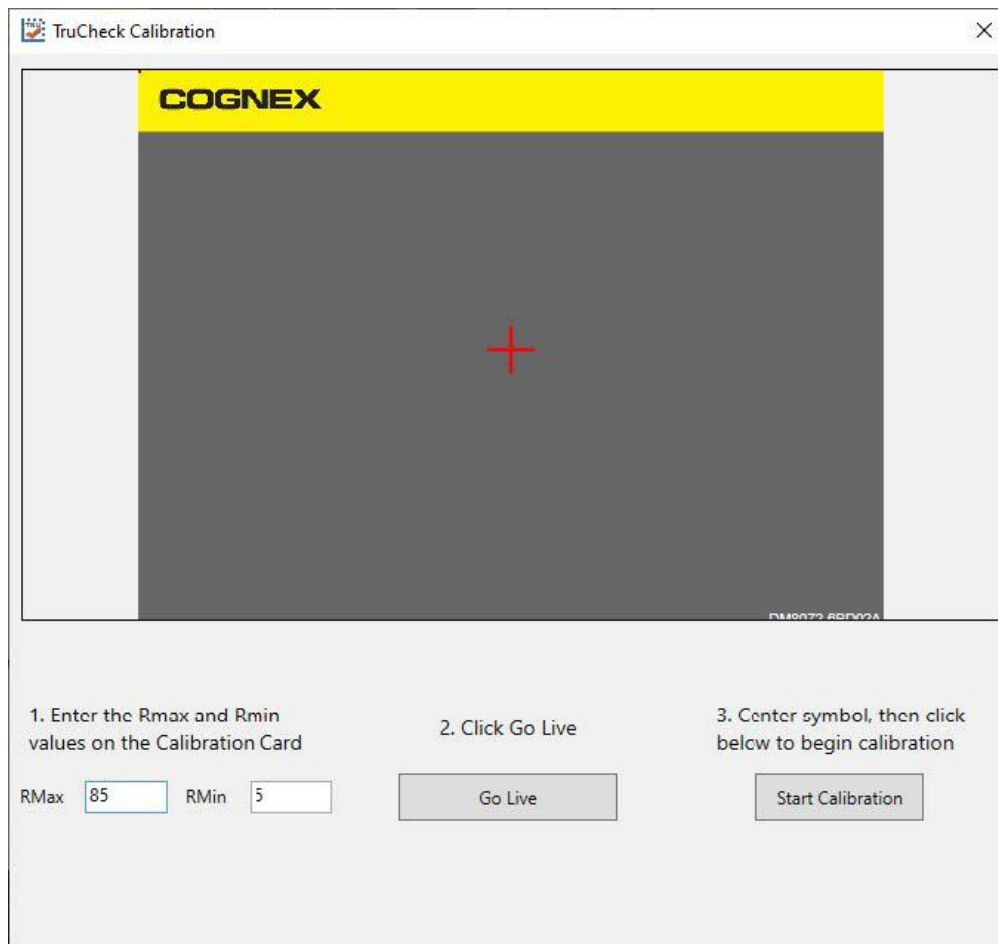

3. Select the **Center Target** button.
4. A live image appears in the Calibration screen. Center the verifier over the calibration symbol.
5. Click **Start Calibration**. A Calibrating progress bar appears in the window.



6. The verifier goes through a series of lighting calibrations. After a successful calibration, two kind of message window pop up.

If you performed the calibration with one of the supported NIST-traceable calibration symbols, the pop-up displays the following:

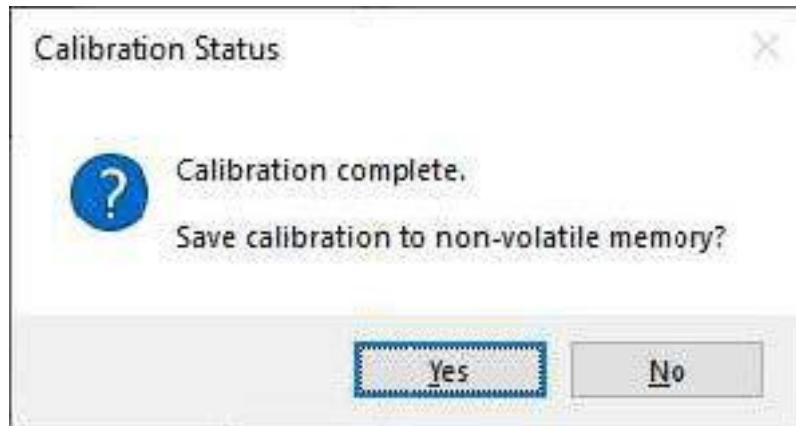

When you perform a successful calibration with a supported NIST-traceable calibration symbol, a calibration time stamp appears on the bottom of the TruCheck window and is printed on the header of the report.

Supported NIST calibration symbols:

- 2D symbol on the Cognex Calibration Card (Cognex #DMV-CCC)
- Symbols 1 and 5 on the Applied Image Conformance Calibration Standard Enhanced Test Card for ISO IEC Datamatrix and GS1 Datamatrix (Cognex #DMV-DMCC)
- Symbol 1 on the GS1 ISO Data Matrix & GS1 Datamatrix Calibrated Conformance Standard Test Card (Cognex #DMV-GS1CC)

If you performed the calibration successfully with any readable symbol other than the supported NIST-traceable calibration symbols, the pop-up displays the following:

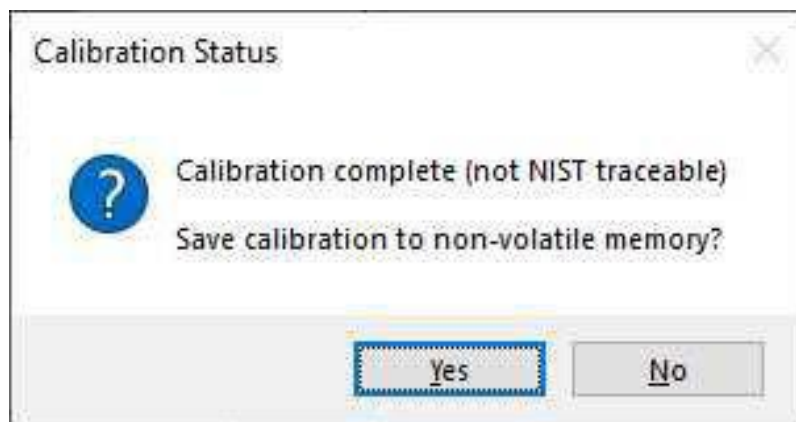

If you perform a successful calibration with a non-NIST-traceable calibration symbol, no calibration date is recorded on the reports or displayed on the Main tab in the TruCheck window.

For both successful calibration messages, you have the options to save the calibration to non-volatile memory.

- If you select **Yes**, the verifier saves the calibration for subsequent verifications and the values to non-volatile memory. If you power down the verifier, the calibration persists.
- If you select **No**, the verifier saves the calibration for subsequent verifications but does not save the values to non-volatile memory. If you power down the verifier, the calibration values get lost.

If the calibration failed, the pop-up displays the following message:

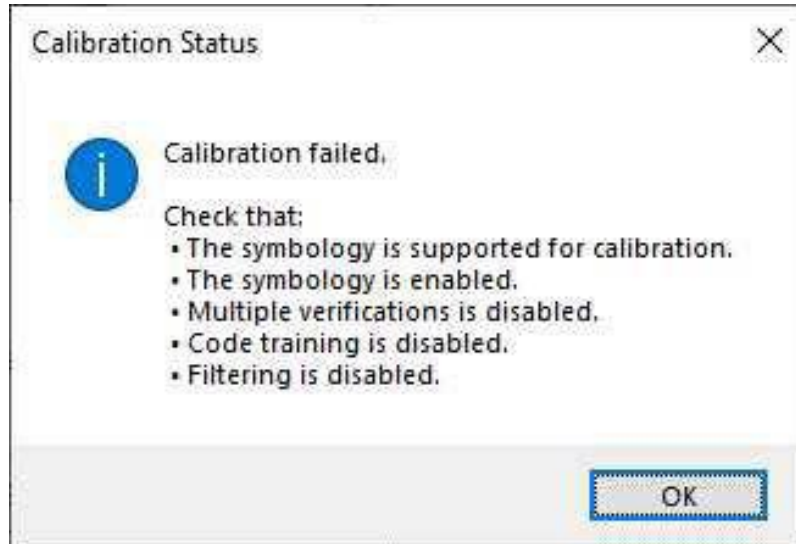

Note:

A failed calibration means that the calibration target is not detected. Make sure that:

- A valid, readable barcode is visible within the field of view
- You have selected the region of interest that includes the barcode that you use for calibration
- The calibration barcode symbology type is supported
- The calibration barcode symbology type is enabled in Code Details tab in the Setup Tool window
- The verifier is not set for multiple verifications
- No filtering is enabled

Calibrate your verifier as needed to ensure accurate verification results. Monthly calibration is recommended, or more frequently where required by internal quality guidelines.

Note: Store the calibration card away from direct light to avoid compromising the calibration symbol.

Enable a calibration reminder in **Calibration Settings** menu to alert you about the next scheduled calibration. After enabling the calibration reminder, set the number of days for prompting a calibration reminder. For more information, see [Calibration Settings on page 42](#).

Click **Discard Calibration** to remove all calibration values and return the verifier to an uncalibrated state.

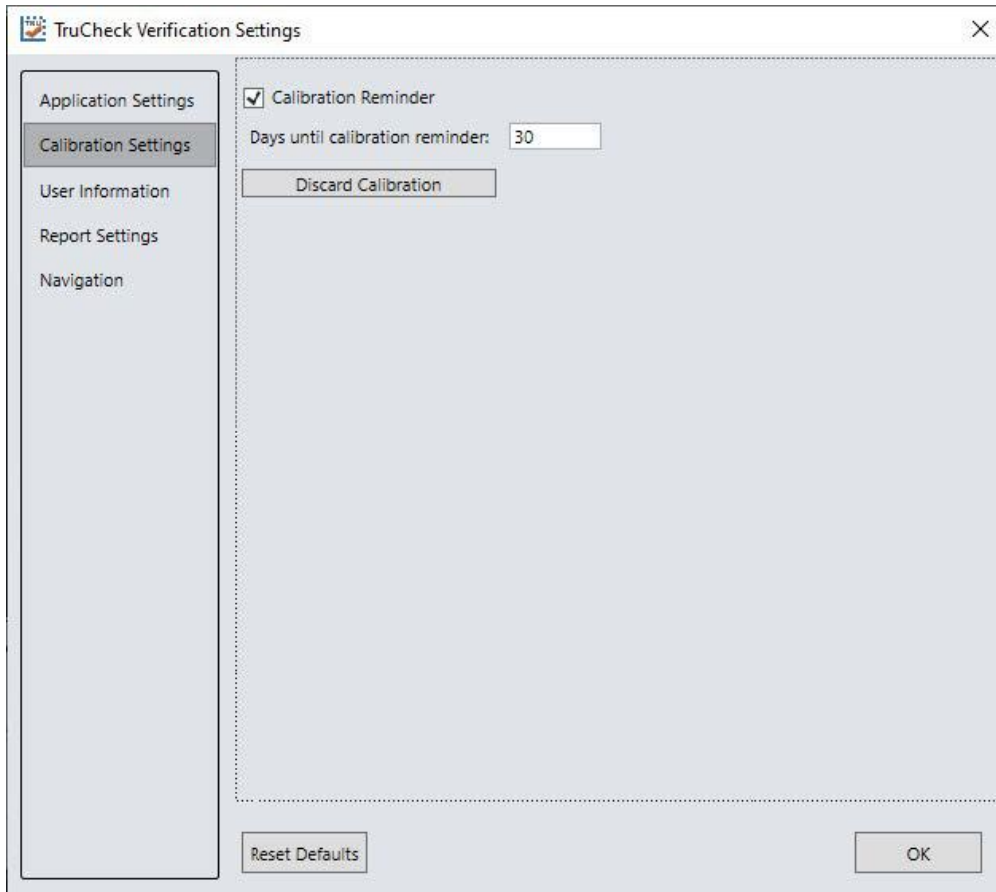

Using Your DataMan 8072V Verifier

Verifying a 2D Barcode

In the TruCheck Verification window, perform the following steps to verify a Data Matrix code or a QR code:

- 1. Navigate to the **Main** tab.
- 2. Select **Go Live**, and center your symbol in the screen. Alternately, press and release the trigger button to **Go Live**.

Note: After selecting **Go Live**, the button changes to **Verify**.

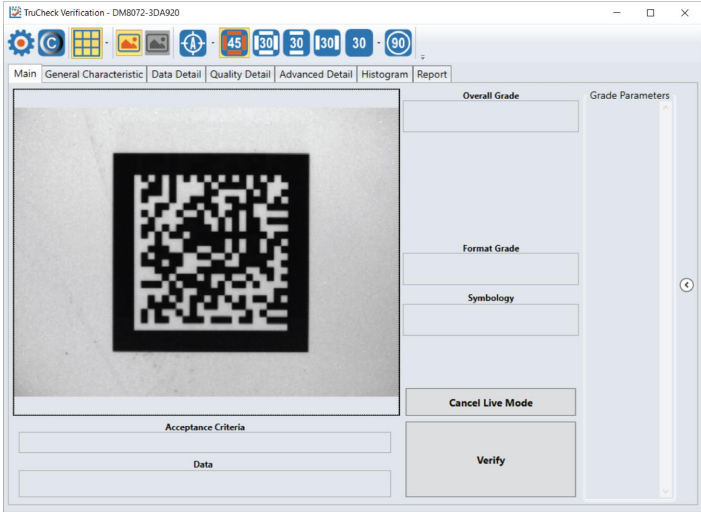

- 3. If necessary, draw a selection region around the code to be verified (see [Selecting Regions on page 23](#)).

Note: You have to draw the region around the outside perimeter of the code including quiet zones.

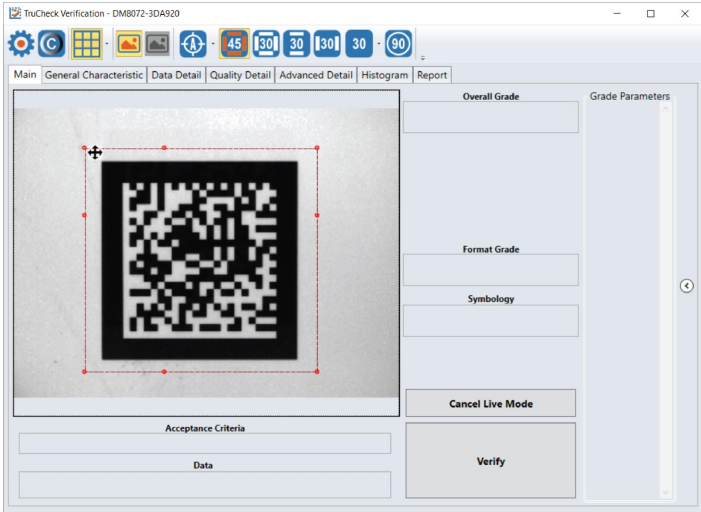

- 4. Once you have made your region selection, click **Verify** or press and release the trigger button on the verifier to begin verification.

Note: The following screenshot shows a successful 2D barcode verification. Depending on grading and application standards, additional details are displayed.

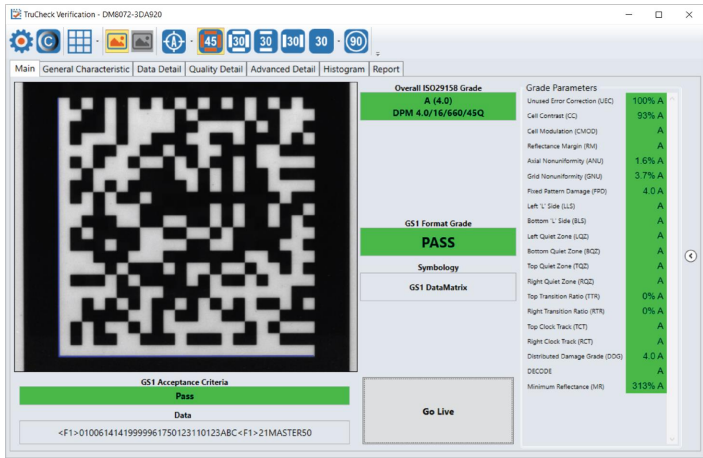

Note: The tool bar buttons and tabs shown on the screen are useful for in-depth analysis of codes. For more information, see [Examining the Results on page 23](#).

Selecting Regions

You have to specify the regions in the live image for the following reasons:

- If the code is off center.
- To speed up the verification process on verifiers with large fields of view. Defining a small sampling area increases the speed.
- To restrict a region used to adjust the image brightness when grading according to AIM-DPM (ISO 29158).
- To specify a barcode for verification when more than one barcode is present in the field of view.

If you do not define a region, the verifier uses the whole image.

To define a region, position your cursor where you want the region to start, hold the left mouse button down and begin drawing a box by moving the mouse. Release the button when you are done.

For Data Matrix symbols and QR Codes, draw the region surrounding the entire code. The verifier needs the entire finder pattern, including quiet zones, within the selection to properly grade the code.

Examining the Results

This section details in a tab-by-tab fashion how the results of the verification can be viewed and analyzed.

Main

After verification, the **Main** menu shows a snapshot of the verification results.

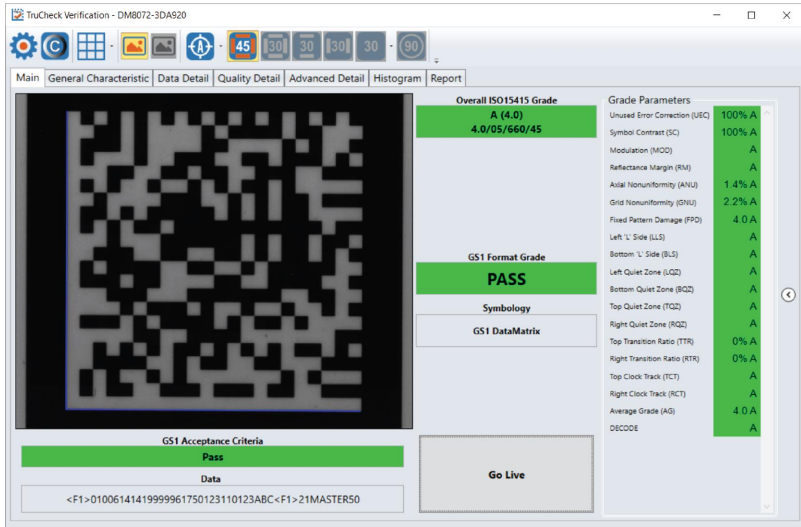

Acceptance Criteria: This box provides a Pass/Fail grade for the barcode and the grades depend on the selected Application Standard.

Data: This box shows the decoded data. If the data is longer than the box provided, the data creates a scroll bar to show the remaining data.

Overall Grade: This box shows the overall grade results for the barcode as both a letter grade and numeric grade in the format of A (4.0). In addition, a Formal Grade is provided in the format “Grade/Aperture/Wavelength/Lighting”. For example, a Formal Grade of “4.0/08/660/45” is interpreted as receiving a grade of 4.0 using 8 mil aperture (0.2 mm), 660 nm wavelength, and 45° lighting.

Format Grade: This box provides the Format Grade of the barcode and is dependent on the selected Application Standard or Data Format Check criteria.

Symbology: This box reports what type of symbology was detected and used for verification.

Grade Parameters: This box provides information on the Quality Parameters grading for the barcode. You can find more detailed information for these parameters on the Quality Detail tab. If the Grade Parameters is not visible on the Main menu, select the arrow on the right side of the menu to open it.

General Characteristics

The **General Characteristic** tab shows the physical characteristics of the verified barcode.

The following image shows the characteristics of a Data Matrix barcode:

General Characteristics	
Matrix Size	22x22 (Data: 20x20)
Horizontal BWG	-2%
Vertical BWG	-4%
Encoded characters	44
Total Codewords	50
Data Codewords	30
Error Correction Budget	20
Errors Corrected	0
Error Capacity Used	0
Error Correction Type	ECC 200
Image	White on Black
Nominal X Dim	19.7 mil
Contrast Uniformity	68 at module(17,10)
MRD	0% (100% - 100%)

The information provided in the General Characteristics tab depends on the verified symbology. For the Data Matrix codes, the following information is provided:

- The **Matrix Size**, showing both the matrix size including the quiet zone, and the matrix size of the data portion.
- The **Horizontal and Vertical Bar Width Growth (BWG)** shows the percentage of the module size. Positive percentage shows the growth and a negative percentage shows the width reduction.
- The **Encoded Characters** shows the total number of characters detected in the barcode.
- The **Total Codewords** shows the total number of codewords detected in the barcode.
- The **Data Codewords** shows the total number of codewords excluding error correction codewords.
- The **Error Correction Budget** shows the budget allowed for error correction for the size of barcode.
- The **Errors Corrected** shows the number of corrected errors in the barcode.
- The **Error Capacity Used** shows the amount of budget for error correction.
- The **Error Correction Type** shows the error correction type is ECC200.
- The **Image** shows if the barcode is Black on White background or White on Black background.
- The **Nominal X-Dimension** is the width of a module.
- The **Contrast Uniformity** is the value of Modulation (MOD) for the worst-case module.
- The **MRD** quantifies the minimum difference anywhere across the barcode. These worst-case black and white modules do not need to be adjacent to one another.

Data Detail

The **Data Detail** tab shows all of the data content of the symbol. Detail depends on the symbology and the selected application standards.

The following screen shows a Data Matrix with encoding information:

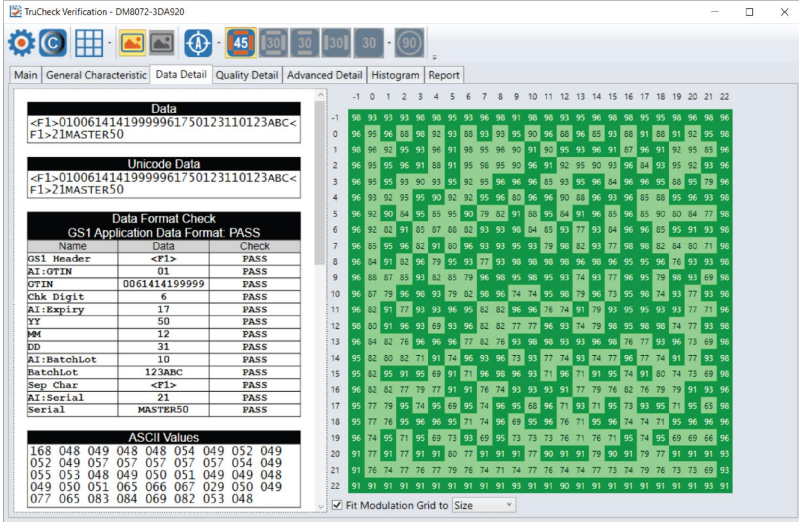

The information in the **Data Detail** menu depends on the verified symbology. For the Data Matrix codes, the following information is provided:

- The **Data** and **Unicode Data** encoded in the barcode.
- The **Data Format Check** table shows the different application standards. The **Data Format Check** table parses into the different parts of the barcode data and provides a pass/fail assessment for each section of the data to ensure that the data conforms to the specification of the application standard. When a data checking failure occurs, a message indicates the cause of the failure. For example, if a check digit is incorrect, a message indicates the expected check digit value. When the verifier detects an error, the verifier reports the error as a failure and the parsing stops.
- The **ASCII Values** table provides a list of the ASCII values for the encoded data.
- The **Codewords** table provides a list of the Codewords for the encoded data. When you place the cursor over the codewords reported in the **Data Matrix Codeword table**, the DataMan Setup Tool highlights the eight modules of that codeword within the image depiction to show where is the encoded data in the data matrix symbol.
- The **Encodation Analysis** table parses the codewords and provide a list of the codewords, the mode, and the resulting data.

Quality Detail

The **Quality Detail** tab shows the measured quality parameters and lists the formal grade. Different symbologies and quality grading standards display pertinent data here.

For example, the following screenshot shows the characteristics of a 2D Data Matrix code graded according to ISO 15415.

The screenshot shows the 'Advanced Detail' tab of the TruCheck Verification software. It displays a table of ISO15415 Quality Parameters. The table has columns for the parameter name, a grade (A), a percentage value, and a pass/fail status. All parameters listed are marked as 'PASS'.

ISO15415 Grade			
Overall	Aperture	Wavelength	Lighting
A (4.0)	5	560	45
Formal			
4.0/05/560/45			
ISO15415 Quality Parameters			
1. Unused Error Correction (UEC)	A	100%	PASS
2. Symbol Contrast (SC)	A	100%	PASS
RURd (100/100)			
3a. Modulation (MOD)	A		PASS
3b. Reflectance Margin (RM)	A		PASS
4. Axial Nonuniformity (ANU)	A	1.4%	PASS
5. Grid Nonuniformity (GNU)	A	2.2%	PASS
6. Fixed Pattern Damage (FPD)	A	4.0	PASS
7. Left 'L' Side (LLS)	A		PASS
8. Bottom 'L' Side (BLS)	A		PASS
9. Left Quiet Zone (LQZ)	A		PASS
10. Bottom Quiet Zone (BQZ)	A		PASS
11. Top Quiet Zone (TQZ)	A		PASS
12. Right Quiet Zone (RQZ)	A		PASS
13. Top Transition Ratio (TTR)	A	0%	PASS
14. Right Transition Ratio (RTR)	A	0%	PASS
15. Top Clock Track (TCT)	A		PASS
16. Right Clock Track (RCT)	A		PASS
17. Average Grade (AG)	A	4.0	PASS
18. DECODE	A		PASS

Advanced Detail

The **Advanced Detail** tab shows the modulation values for each module of the barcode, including the quiet zone. The below example shows the modulation values from a Data Matrix symbol:

The screenshot shows the 'Advanced Detail' tab of the TruCheck Verification software, displaying a grid of modulation values for a Data Matrix symbol. The grid consists of 22 rows and 22 columns of numerical values, representing the modulation of each cell in the barcode.

-1	98	93	93	98	98	95	93	96	96	91	98	95	95	95	96	98	95	95	96	96	96	96	
0	98	98	98	98	98	98	98	98	98	98	98	98	98	98	98	98	98	98	98	98	98	98	
1	98	96	93	95	93	96	91	98	95	96	93	90	95	93	96	91	87	96	91	92	95	85	96
2	96	95	95	96	91	88	91	95	98	95	96	91	92	95	90	93	96	82	93	95	92	93	96
3	96	95	95	93	90	93	95	92	95	96	96	83	93	95	96	84	96	95	95	88	95	79	96
4	96	93	95	95	90	92	95	98	93	96	90	88	96	93	96	83	96	83	95	96	93	98	98
5	96	95	95	94	95	95	95	92	99	92	98	95	94	91	96	89	95	95	95	92	94	93	94
6	96	95	93	91	85	87	88	82	81	93	94	94	94	93	93	93	84	96	95	95	91	93	96
7	96	95	96	82	91	80	96	93	93	95	93	79	98	82	93	97	98	98	82	84	80	71	98
8	96	94	91	82	96	79	95	93	97	93	98	98	98	96	96	96	95	95	95	94	73	93	98
9	96	88	85	93	82	85	79	96	98	95	98	95	93	74	93	97	96	95	79	98	93	69	98
10	96	87	79	96	98	93	79	82	98	96	74	74	95	98	79	96	93	95	98	74	93	77	98
11	96	82	91	97	93	93	96	95	92	82	96	96	74	74	91	79	93	95	95	93	93	77	96
12	96	80	91	96	93	89	93	96	92	82	77	77	96	93	74	79	98	95	98	96	77	93	98
13	96	82	82	78	96	96	96	97	82	84	93	96	98	93	89	96	98	83	77	93	96	73	98
14	95	85	80	82	73	91	82	96	93	98	93	93	97	74	93	94	93	93	91	75	81	77	93
15	95	85	91	95	89	91	87	96	96	96	93	71	96	71	81	95	94	83	80	74	73	80	98
16	95	82	82	77	79	77	91	91	79	74	93	93	91	77	79	82	76	79	79	91	93	96	98
17	95	77	79	95	74	95	89	95	74	96	95	96	91	93	71	95	73	93	95	71	95	85	98
18	95	77	78	95	96	96	95	71	74	96	95	96	76	71	95	96	74	74	71	95	96	96	96
19	96	74	98	71	95	89	73	93	89	95	73	73	76	71	76	71	95	74	95	69	69	66	96
20	91	77	91	77	91	91	80	77	81	91	93	77	90	91	91	79	90	91	79	77	91	91	93
21	91	76	74	77	76	77	79	76	74	71	74	77	76	74	74	77	73	74	79	79	73	69	93
22	91	91	91	91	91	91	91	91	91	91	91	91	91	91	91	91	91	91	91	91	91	91	91

Histogram

The **Histogram** tab shows the analysis of the reflectivity and associated grade of each cell.

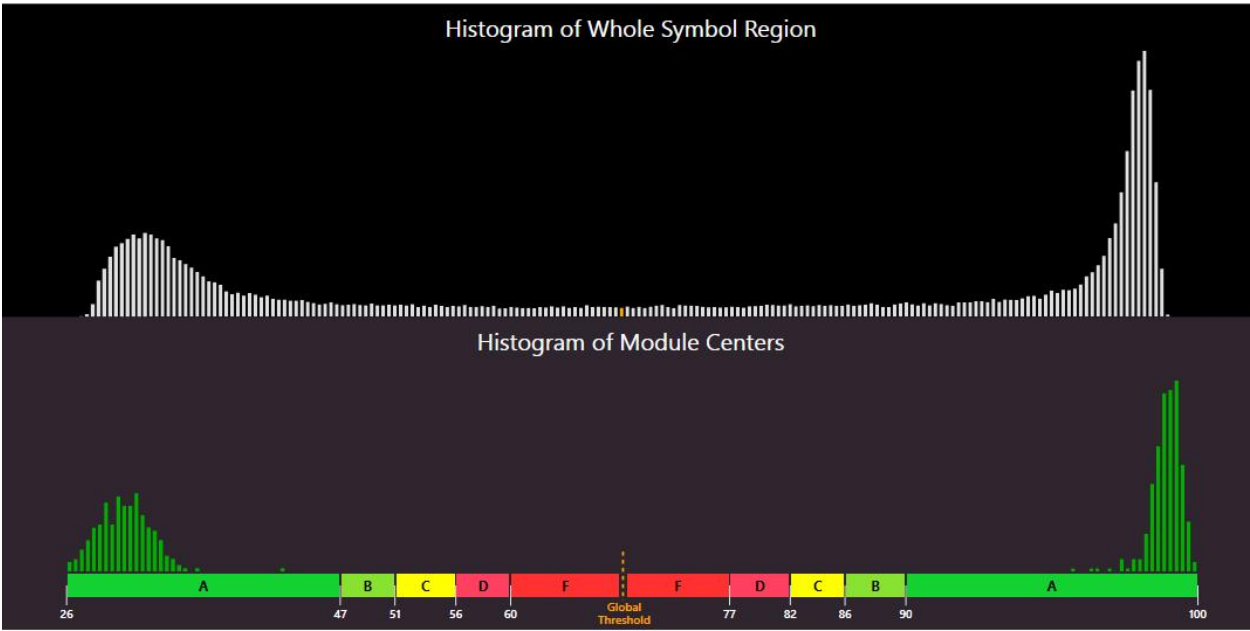

The horizontal axis on the histogram represents the brightness level, with the dark elements on the left and the bright elements on the right. The brighter the element is, the further to the right it gets. The height of each bar represents the number of elements with the brightness associated with its position on the horizontal axis.

The top graph is a histogram representing the brightness of all the pixels in the image. The bottom graph only represents the center of modules in the symbol. As expected, the bottom graph does not contain elements which are not either definitively dark or definitively bright. While all the dark or bright modules are not exactly the same in brightness, they are relatively close to each other and that is why the bars are grouped together. In the upper histogram, some pixels, which are in between dark and bright modules and thereby obtain a middle value of brightness.

The horizontal axis contains markers showing the global threshold (tall line) and the separation between B and C, and between C and D modulation levels for both dark and light elements.

Report

The **Report** tab shows a preview of the report:

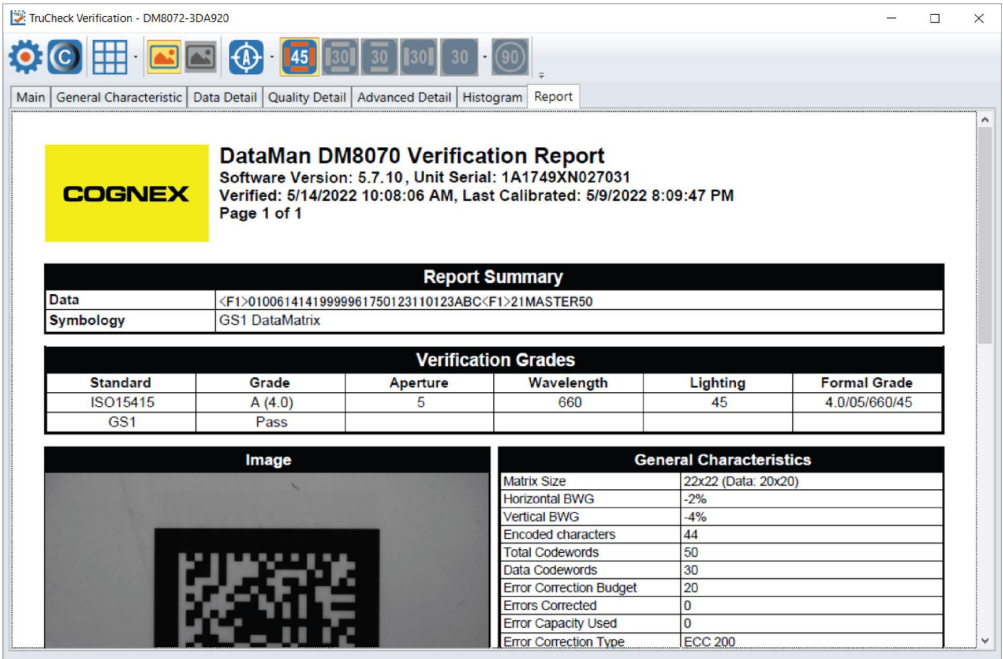

You can save and print the report by right-clicking on the report and selecting **Print**.

Alternatively, you can save and print electronic reports by enabling the Code Quality report in the DataMan Setup Tool window and designating a file pathway to save the reports:

1. Open the DataMan Setup Tool, and navigate to the **Results History** pane.
2. In the **Logging** drop-down menu, click on the **Generate Code Quality reports**.

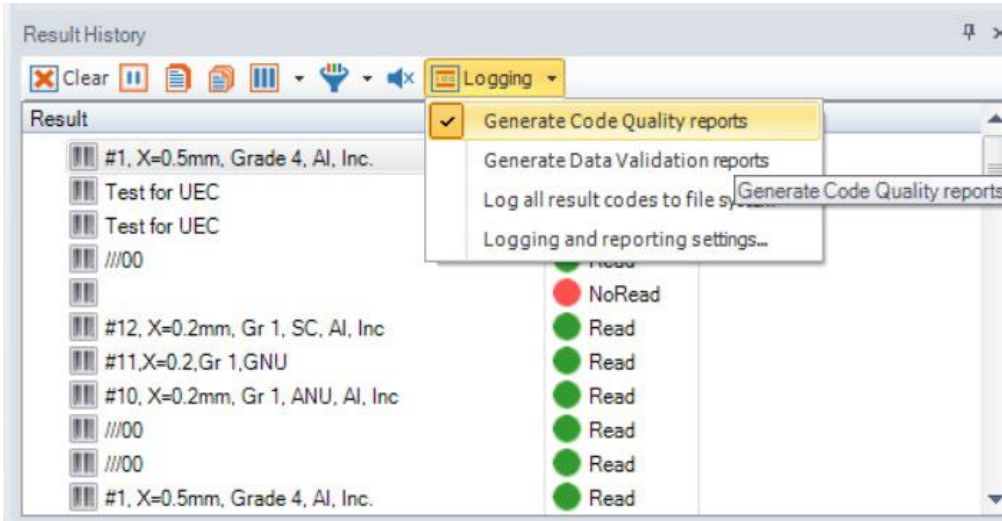

3. In the same drop-down menu for **Logging**, select **Logging and Reporting Settings** to open the **DataMan Setup Tool Options** window.



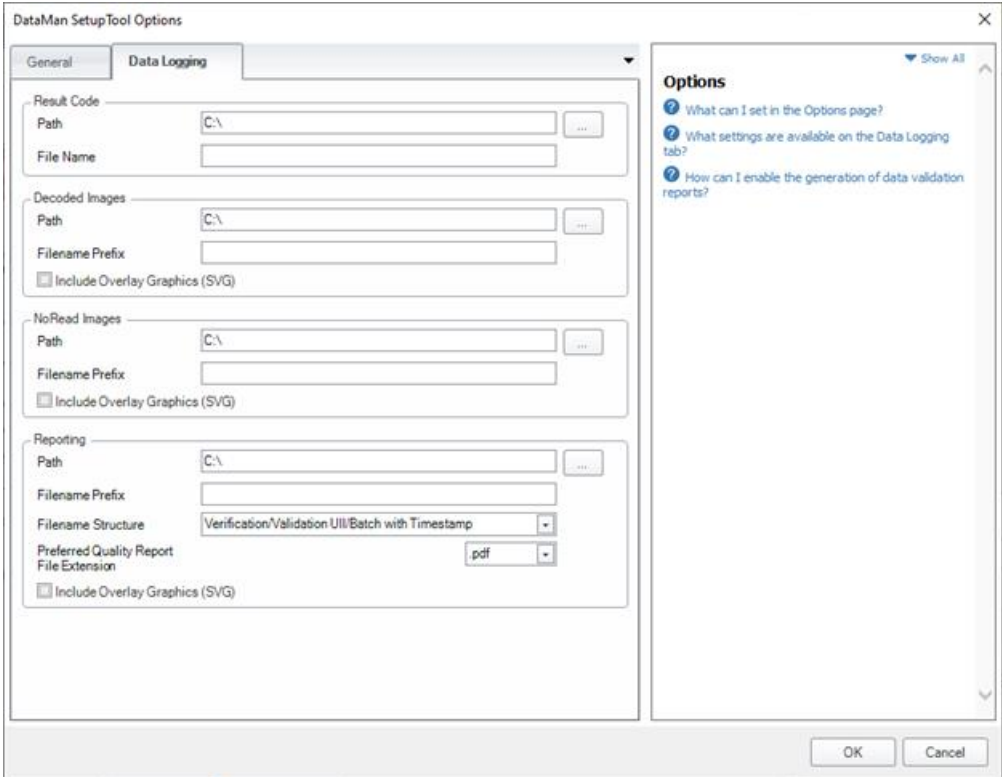

- 4. In the **Reporting** box, select the **Path** to save verification reports to your local computer or server. Include a **Filename Prefix** or **Filename Structure** and select the **Preferred Quality Report File Extension** as either *.html* or *.pdf* file.



User Interface

This section describes the settings and options of the TruCheck Verification window.

Toolbar

Icon	Function
	Settings: Opens up the settings menu where you can make changes to the Application Settings, the Reporting Settings and the User Information menu. For more information, see Settings on page 33 .
	Calibration: Opens up the calibration window so you can calibrate the unit. For more information, see Calibration on page 17 .
	Grid & Modulation Circles: When you select, the tool applies a grid and/or modulation circles to the image after verification. By using the drop-down menu options, you can apply a Real Grid, an Ideal Grid, or both. In addition, you can select to either show Mod Circles Filled or Mod Circles Outlined. When you unselect the tool, neither Grid, nor Mod Circles show on the image.
	Original Image: Shows the original image used for verification.
	Focusing Indicator: When using the verifier with the optional stand, enabling this feature shows a focusing indicator in the image window that is for adjusting the height of the stand so that the verifier views the target code at the proper focal distance. For more information, see Adjusting the Focus Height on page 30 .

Adjusting the Focus Height

The DataMan 8072 Verifier can be equipped with an optional adjustable height stand that is guided by a focus indicator. When using the optional stand, prior to verifying, the verifier needs to be adjusted to the proper height above the target to ensure proper focus.

Do not use the focusing indicator with the standoff in handheld mode. When used without the stand, the standoff itself is used to achieve the correct focus distance.

Note: If you enable the focus indicator while using the standoff, you can notice that the focus indicator is slightly above or below the target circle. This is because the standoff is nominally at the same height as the stand, but there are slight tolerances. There is some depth of field around the focus height so it can be above or below when it is still in focus.

To adjust the focus, perform the following steps in the TruCheck Verification window:

1. Place the symbol directly under the verifier and press the **Go Live** button. A live image appears on the screen.
2. When the **Focus Indicator** is enabled, you see a target circle in the center of the image window. Additionally, an image of the indicator spot appears somewhere on the image along the vertical center axis.

Note: It is possible for the indicator spot to fall outside the field of view. In that case, adjust the height of the imager until the indicator spot appears in the image window.

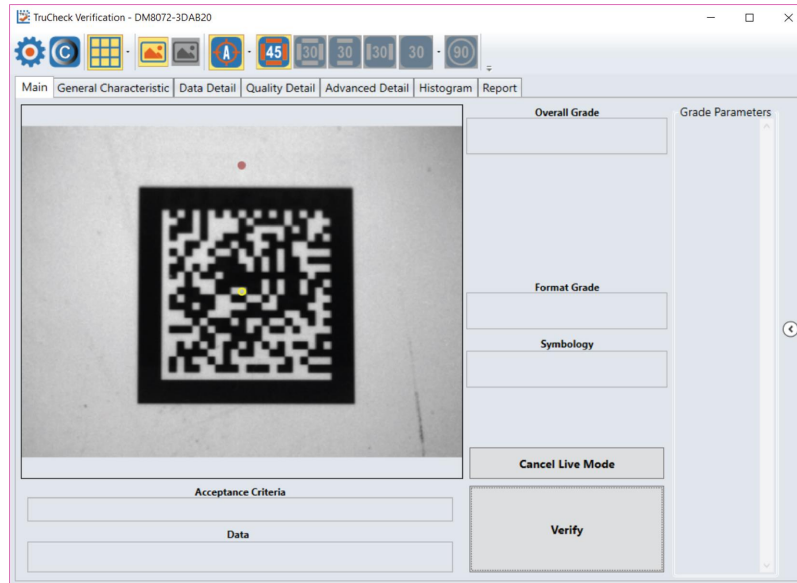



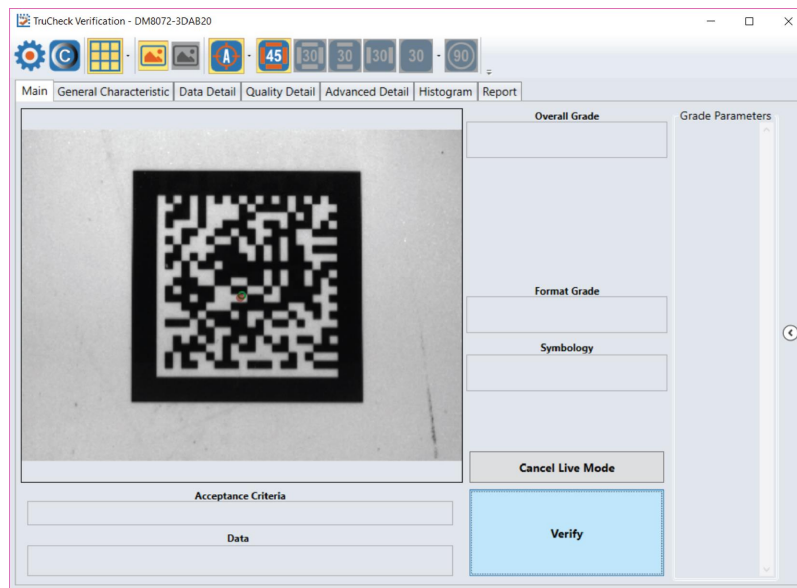



3. Carefully rotate the crank on the top of the verifier stand until the indicator spot is in the same position as the circle. At this point the circle turns green, indicating that the unit is in focus.



Illumination Icons

Direct Part Mark (DPM) verifiers have multiple lighting options to grade according to various grading methodologies and standards (such as AIM-DPM). When verifying using ISO 15415, only the 45Q lighting option is available for selection; when verifying using ISO 29158 (AIM-DPM), all lighting options are available for selection.

Note: Some lighting options are not allowed in some application standards. Only select options that provide you with a result that is valid for your application. It is common to use AIM-DPM as the basis for grading when working with DPM symbols and lighting other than 45-degree light from four sides.

Icon	Function
	This icon selects 45° illumination. 45° four-sided illumination is used primarily for labels. This illumination is either not reported or is reported as 45Q. (If illumination is not reported, it is assumed to be 45Q).
	This icon selects 30° illumination from four sides. It may reduce glare from some substrates, which cause poor Symbol Contrast or Modulation grading. This illumination is reported as 30Q and is used primarily for DPM applications.
 	These icons select 30° two-sided illumination. This illumination can be from either the North/South or East/West. These are useful on cylindrical surfaces. Select them parallel to the axis of the cylinder. This illumination is reported as 30T.
	This icon selects one side of the 30° lighting to be used. Use the dropdown menu to select one of the four sides for 30° lighting. If you select this lighting option but you do not select any individual lighting side, the top 30° lighting is used. This illumination is reported as 30S.
	This icon selects 90° diffuse illumination and works well on very shiny substrates and Dot Peen Applications. This illumination is reported as 90.

Settings

This section describes the settings you can make and the options you have in the TruCheck Verification window.

Accessing the Settings Menu

To access **Settings**, select the **Settings** icon in the upper left hand corner of the interface.

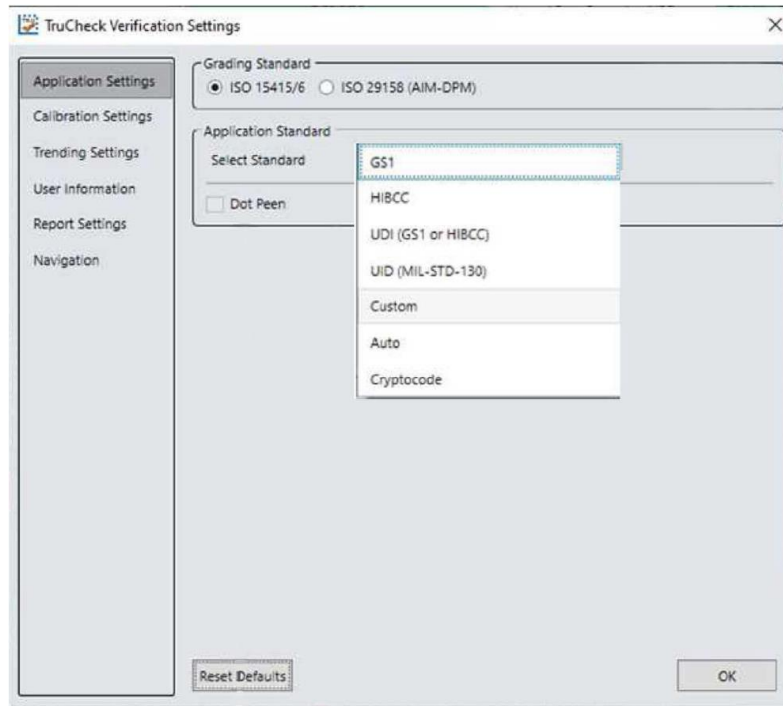

Application Settings

The contents of the **Application Settings** window depend on the **Application Standard** that you select. The standard application setting automatically sets many of the parameters.

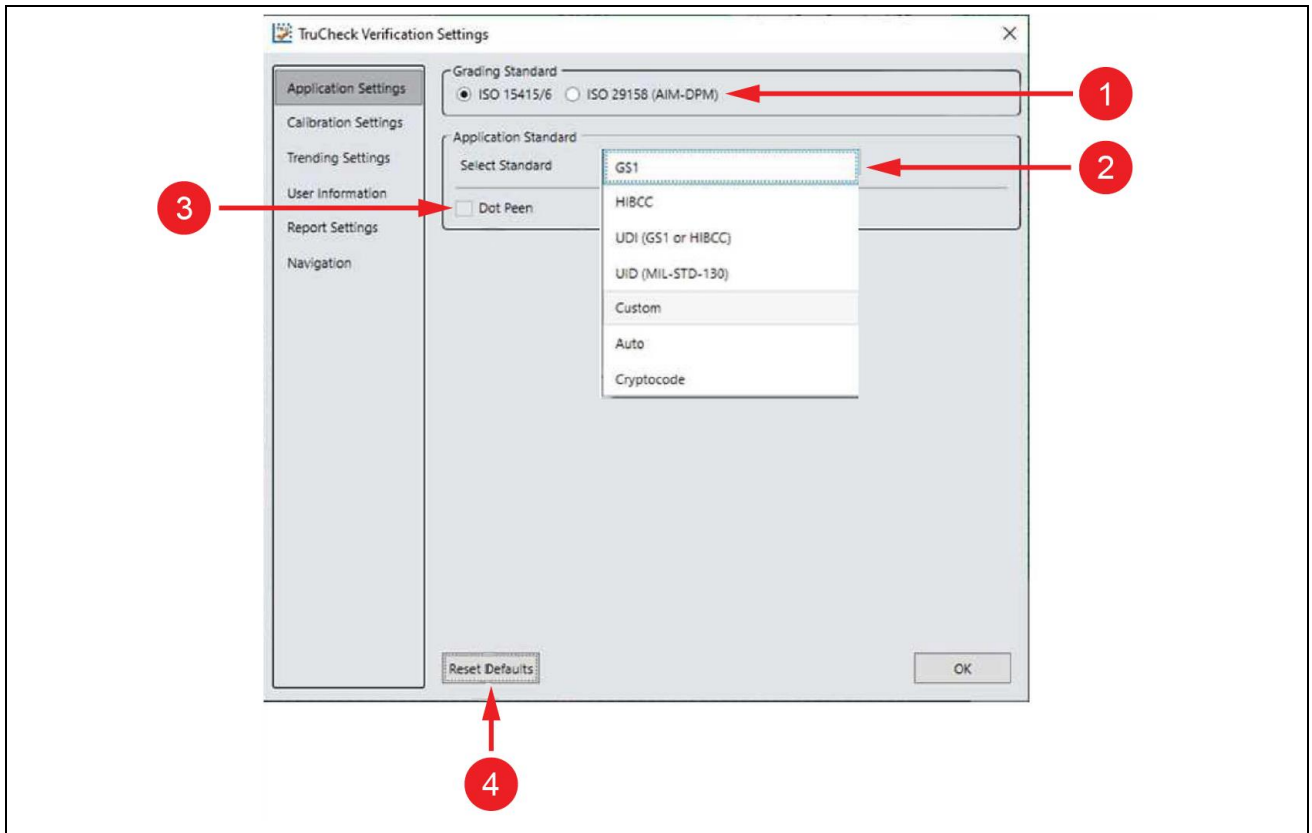

Number	Element	Description
1	Grading Standard	<p>For any Application Standard selected, you need to select a Grading Standard, depending on your application.</p> <p>Available options are:</p> <ul style="list-style-type: none"> • ISO 15416 for 1D barcodes • ISO 15415 for 2D barcodes printed on a label • ISO 29158 (AIM DPM) for 2D DPM barcodes <p>For more information, see support.cognex.com, and navigate to <i>Resources > Introduction to Barcode Verification</i>.</p>
2	Application Standard	<p>You can select pre-defined and custom application standards.</p> <ul style="list-style-type: none"> • Selecting a pre-defined application standard ensures that the DataMan 8072 Verifier uses the appropriate grading parameters for your application. • Custom application standard allows you to customize all adjustable verification and process parameters.

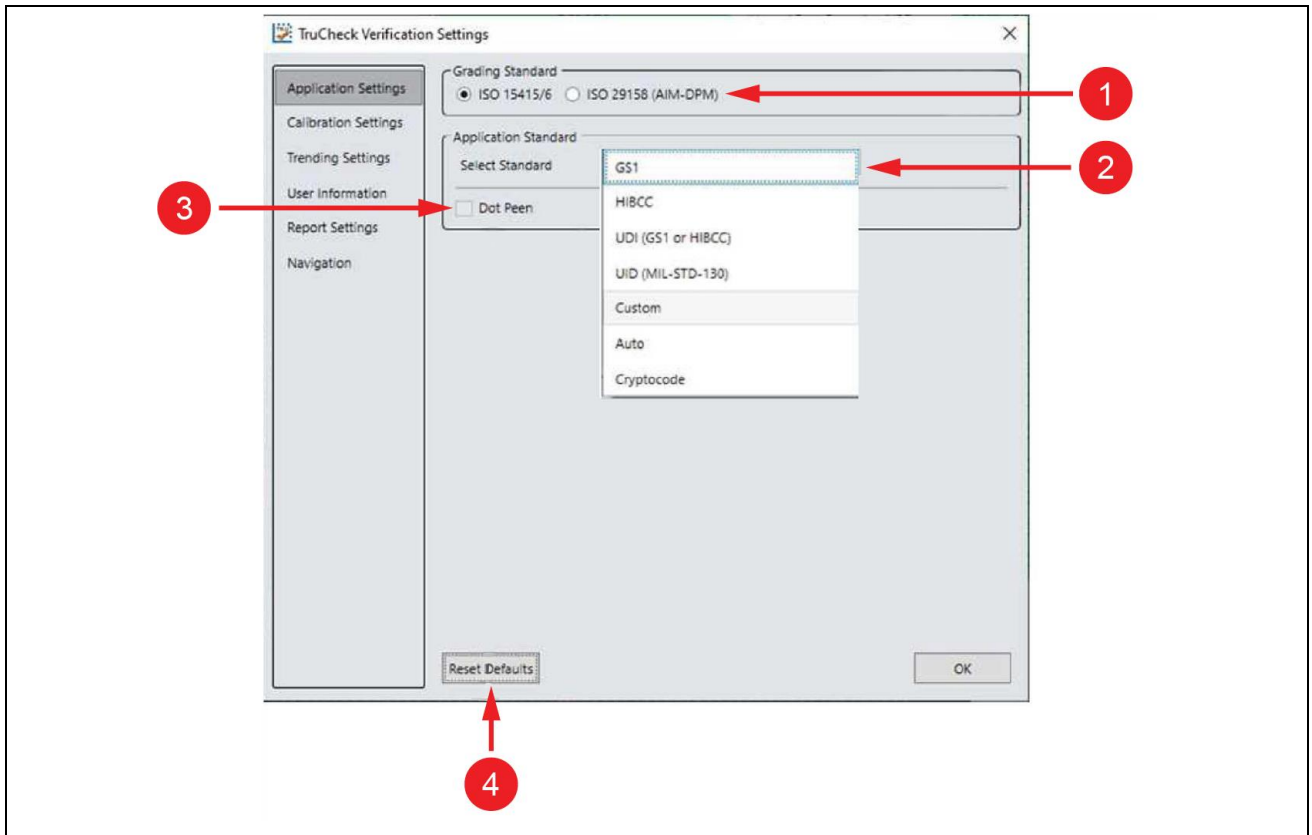

3	Dot Peen	The Dot Peen option connects dots for codes created through a process where dots are peened onto a metal surface. Select Dot Peen to use the AIM-DPM Stick algorithm to connect the dots.
4	Reset Defaults	<p>Select the Reset Defaults button to reset the Settings menu to the default settings.</p> <p>Note: After clicking on the Reset Defaults button, you have to recalibrate the verifier.</p>

Application Standards Settings

The Application standards configure the DM8072V to grade the code according to pre-defined industry standards.

Select one of the options in the drop-down box to specify the application standard.

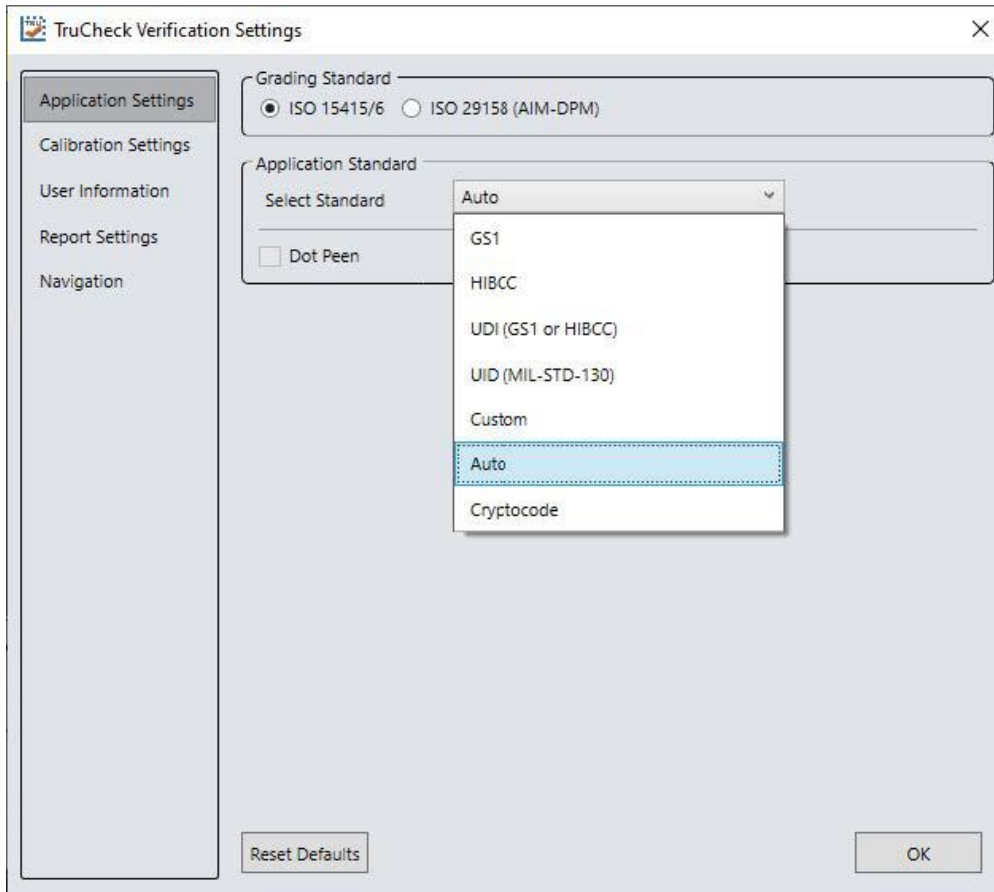

The available options are:

- Pre-defined:
 - GS1
 - HIBCC
 - UDI (GS1 or HIBCC)
 - UID (MIL-STD-130)
 - Auto
 - Cryptocode
- Custom

Pre-defined Application Standards

You can choose from the following pre-defined application standards:

GS1

The **GS1** application standard follows the GS1 General Specification guidelines in code verification. The GS1 General Specification Tables 1-11 describe the categories of applications. Select from the tables to specify the application category for your codes.

TruCheck Verification Settings

Application Settings

Calibration Settings

User Information

Report Settings

Navigation

Grading Standard

ISO 15415/6 ISO 29158 (AIM-DPM)

Application Standard

Select Standard: GS1

Dot Peen

Auto (Warn if Ambiguous)

Automatically Determine which GS1 Table to be used

Reset Defaults OK

If you select **Auto (Warn if Ambiguous)**, the most applicable GS1 General Specification Table is automatically selected for you.

Auto (Warn if Ambiguous)

Table 1

Table 2

Table 3

Table 4

Table 5

Table 6

Table 7

Table 8

Table 9

Table 10

Table 11

Note: The DM8072V uses the X-Dimension of the decoded symbol to deduce which GS1 Table applies. If the X-Dimension is outside the range allowed in your application, the results become incorrect. To make sure that the verifier is checking all the proper requirements for your application, select the Table in the GS1 General Specification that apply to your application.

The selected GS1 table is available in the Notes section of the report. For more information on the tables used for analysis, see www.gs1.org.

Select **Dot Peen**, if applicable.

HIBCC

The **HIBCC** application standard checks data formatting and minimum quality according to The Health Industry Supplier Labeling Standard guidelines.

UDI (GS1 or HIBCC)

The **UDI (GS1 or HIBCC)** application standard checks symbols that meet UDI requirements using either GS1 or HIBCC guidelines.

Select **Dot Peen**, if applicable.

Since the data content required for UDI compliance varies depending on the medical device, the verifier only validates the data format (but not the content). The verifier automatically validates data according to GS1 or HIBCC formatting rules.

UID (MIL-130-STD)

The **UID (MIL-STD-130)** application standard reports the quality standard which grades the code and reports the data structure used in Construct 1 or Construct 2 for UID marks specified in MIL-STD 130. The MIL-STD spells out acceptable grades and requirements for data format.

Select **Dot Peen** if it is applicable.

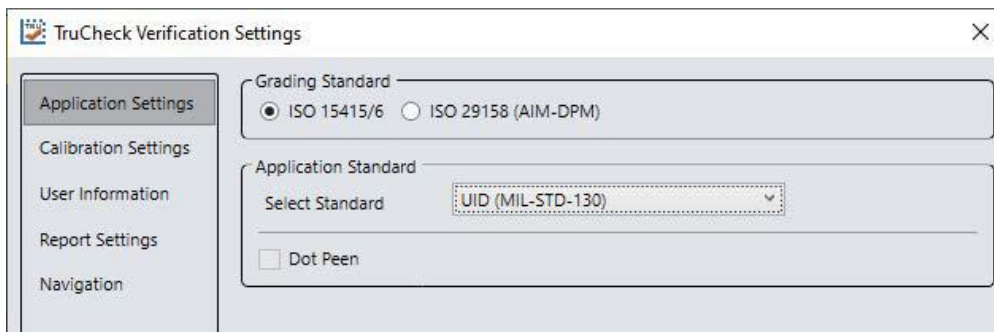

The screenshot shows the 'TruCheck Verification Settings' dialog box. On the left is a navigation pane with 'Application Settings' selected. The main area has two sections: 'Grading Standard' with radio buttons for 'ISO 15415/6' (selected) and 'ISO 29158 (AIM-DPM)'; and 'Application Standard' with a dropdown menu set to 'UID (MIL-STD-130)' and a 'Dot Peen' checkbox that is unchecked.

Auto

Apply the **Auto** application standard to allow the verifier to select the correct application standard based on the format of the data encoded in the symbology. If the verifier detects GS1, HIBCC or MIL-STD 130 standards within a symbology during verification, the verifier chooses the correct application standard.

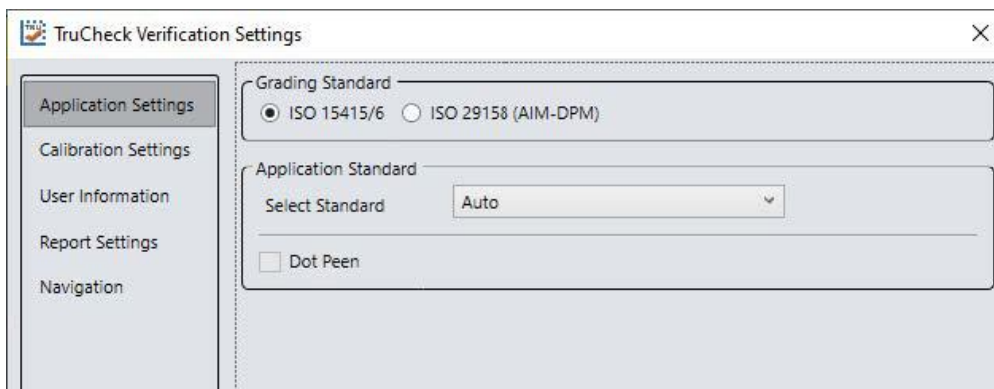

The screenshot shows the 'TruCheck Verification Settings' dialog box. On the left is a navigation pane with 'Application Settings' selected. The main area has two sections: 'Grading Standard' with radio buttons for 'ISO 15415/6' (selected) and 'ISO 29158 (AIM-DPM)'; and 'Application Standard' with a dropdown menu set to 'Auto' and a 'Dot Peen' checkbox that is unchecked.

Note: Select the **Custom** application standard instead of **Auto**, if the symbology contains data structure that the automatic grading standards cannot handle.

Cryptocode

The **Cryptocode** application standard checks symbols that meet Russian Cryptocode standard or other Cryptocode applications.

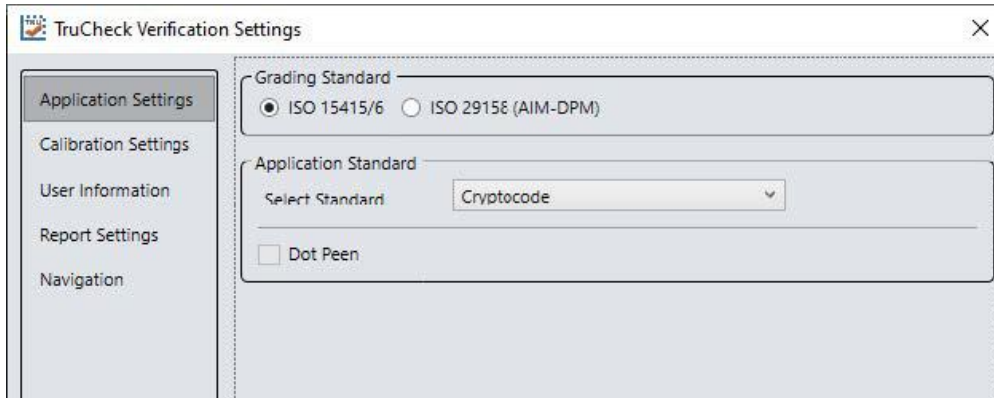

Custom Application Standard

Apply the **Custom** application standard when you are grading a code that is not expected to adhere to any pre-defined industry conformance standard. You can use the following settings for customization:

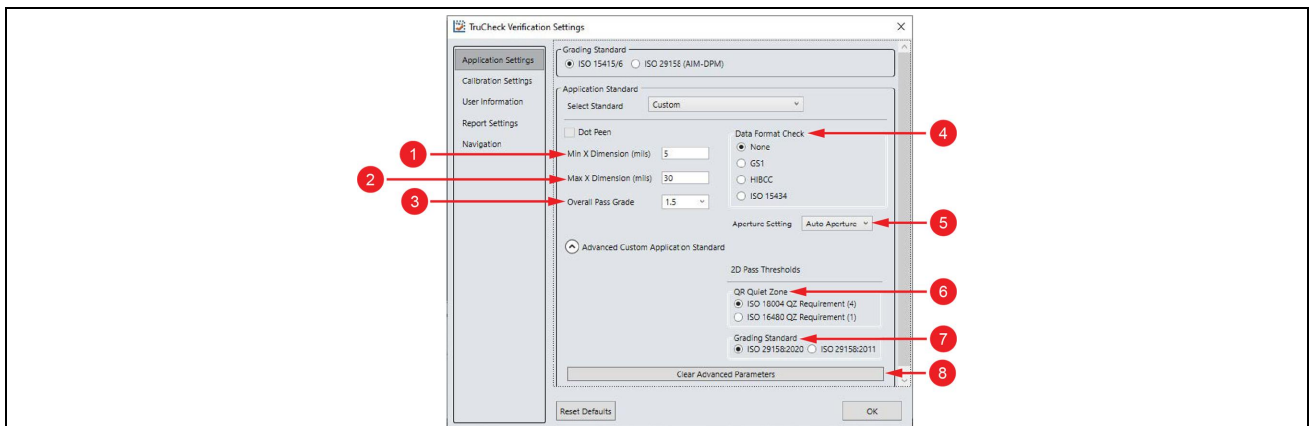

Number	Element	Description
1	Min X Dimension (mils)	You can set a minimum X-Dimension value for verification. The lowest possible value is 1 mil. Any code that falls below the minimum selected X-Dimension receives a grade of Fail (<i>X-Dimension out of Range</i>). The default value is 5 mils.
2	Max X Dimension (mils)	You can set a maximum X-Dimension value for verification. The highest possible value is 100 mils. Any code that is above the maximum selected X-Dimension receives a grade of Fail (<i>X-Dimension out of Range</i>). The default value is 30 mils.
3	Overall Pass Grade	Select a minimum passing grade based on a certain letter or numerical value (for example, C > 1.5). Any verified code that receive an Overall Grade below the minimum Pass Grade receives a Fail for Pass Grade.

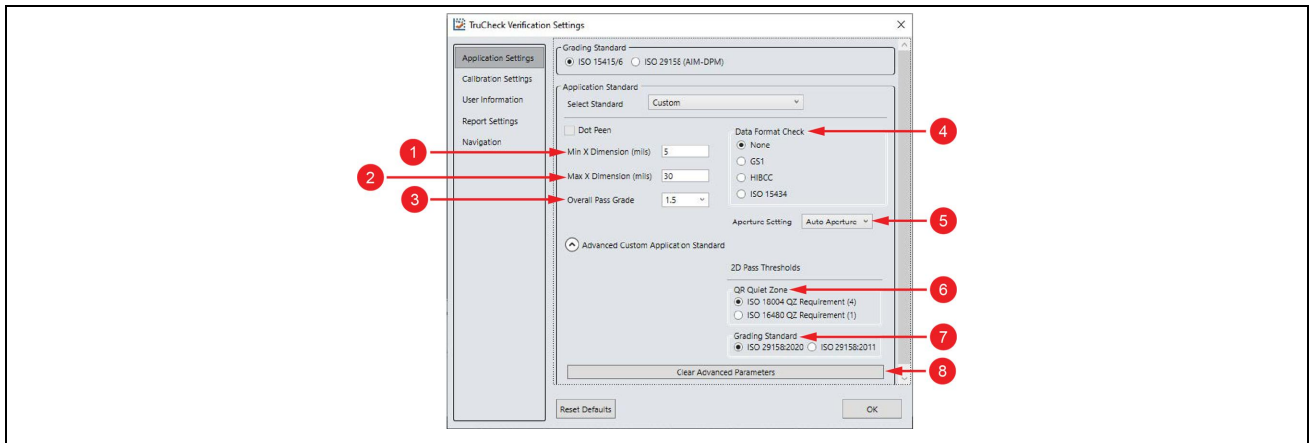

4	Data Format Check	<p>You can apply a specific Data Format Check criteria to the data content of the code or leave the option as None. If a specific Data Format Check is applied, a Data Format Check grading box appears on the main screen of the TruCheck window to show the Pass/Fail grade. The report provides a Data Format Check table that shows more detailed parsing information.</p> <ul style="list-style-type: none"> • None: If you click None, no Data Format Check criteria applies to the data content. • GS1: Checks the format of the data against GS1 formatting rules. These codes generally begin with a Function 1 <F1> character. • HIBCC: Checks the format of the data against HIBCC formatting rules. These codes generally begin with a + character. • ISO 15434: Checks data for industry standards which encode information using ISO 15434 data structures. These codes generally begin with the sequence]]><RS>nn<GS> where the nn are two digits which are typically 05, 06 or 12. MIL-STD 130 and some shipping container applications use this formatting style.
---	-------------------	---

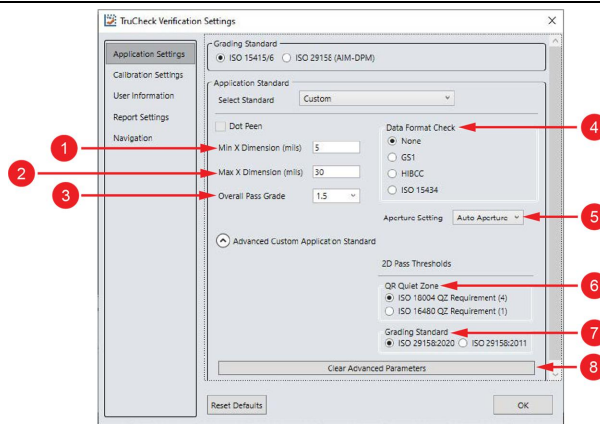

5

Aperture Setting

The size of the synthetic aperture is for producing the blurred reference image that is an integral part of ISO 15415 grading. Choose the size of the aperture with care because it has a profound effect on the grade, according to the requirements of your application. Larger aperture sizes reduce the sensitivity to defects in printing, and reduce the ability to resolve small elements in a code.

The aperture size can be called out in the application specification, quality specification, or both. If you are unsure which aperture size to select, choose **Auto Aperture** and the verifier chooses an aperture size based on the X-Dimension of the code.

Note: You cannot choose an aperture setting when you use **ISO 29158 (AIM-DPM)**.

The AIM-DPM grading includes a blurred reference image, like ISO 15415, the aperture size is dictated by the AIM-DPM grading method to be either 50% or 80% of the X-Dimension automatically.

You have to specify an aperture size for the **Custom** standard when using ISO 15415. In the drop-down menu, select one of the following:

- **User Set:** The application allows you to specify the aperture setting in mil. When you select **User Set**, an additional drop-down menu pops up for you to select the correct aperture.
- **Auto 50%/80%:** The application automatically chooses an aperture size based on the 80% of the X-Dimension for Data Matrix and QR Code symbols.
- **Auto Aperture:** The application automatically chooses an aperture size based on the X-Dimension. For more information, see the table below:

X-Dimension	Aperture
Less than 6 mil	02 (2 mil)
6 mil to 7.5 mil	03 (3 mil)
7.5 mil to 10 mil	05 (5 mil)
10 mil to 20 mil	08 (8 mil)
20 mil to 30 mil	16 (16 mil)
More than 30 mil	20 (20 mil)

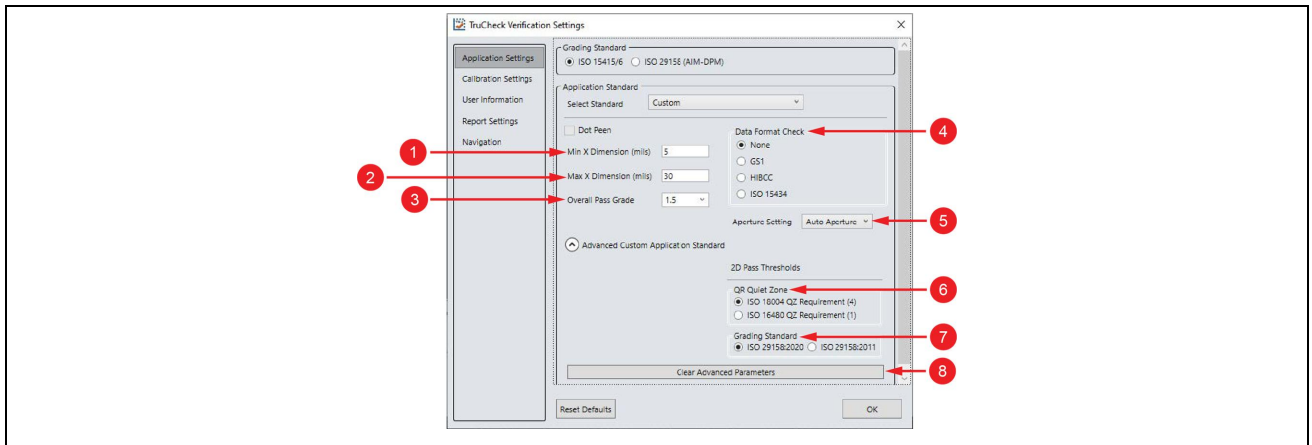

6	QR Quiet Zone	You can use either ISO 18004 Quiet Zone Requirement of a four module-sized quiet zone or ISO 16480 Quiet Zone Requirement of a one module-sized quiet zone.
7	Grading Standard	You can choose between the following ISO standards: <ul style="list-style-type: none"> • ISO 29158:2020 • ISO 29158:2011
8	Clear Advanced Parameters	Resets all values back to default.

Calibration Settings

The **Calibration Settings** menu allows users to enable a reminder for calibration.

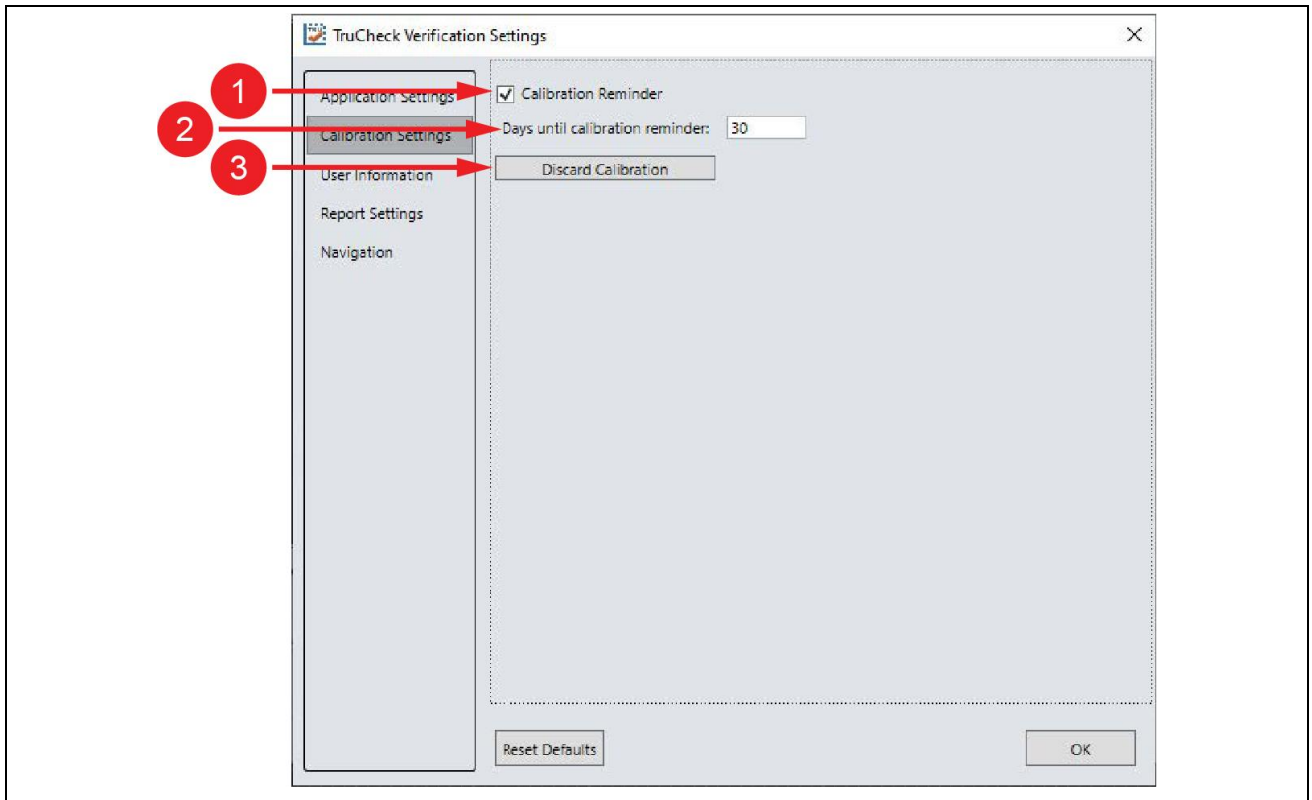

Number	Element	Description
1	Calibration Reminder	Check the Calibration Reminder checkbox to enable a reminder for calibration.
2	Days until calibration reminder	Set the number of days until the next reminder appears.
3	Discard Calibration	Return the verifier to an uncalibrated state.

User Information

The **User Information** menu allow you to include additional information in the report.

The screenshot shows the 'TruCheck Verification Settings' dialog box. The 'Report Settings' section is selected in the sidebar. The main area contains the following elements:

- 1**: A red box highlights the input fields for 'Company Name', 'Operator Name', and 'Batch Number'.
- 2**: A red arrow points to the 'Auto Batch' checkbox.
- 3**: A red arrow points to the 'Report Settings' menu item in the sidebar.

At the bottom of the dialog are 'Reset Defaults' and 'OK' buttons.

Number	Element	Description
1	Company Name, Operator Name, Batch Number	Add Company Name , Operator Name , and Batch Number to include them in the header of the report.
2	Auto Batch	Check the Auto Batch checkbox to add any batch number detected in the barcode to the report.
3	Custom Note	Add any additional information to the report.

Report Settings

The **Report Settings** menu allows you to select the unit of measurement for reporting values.

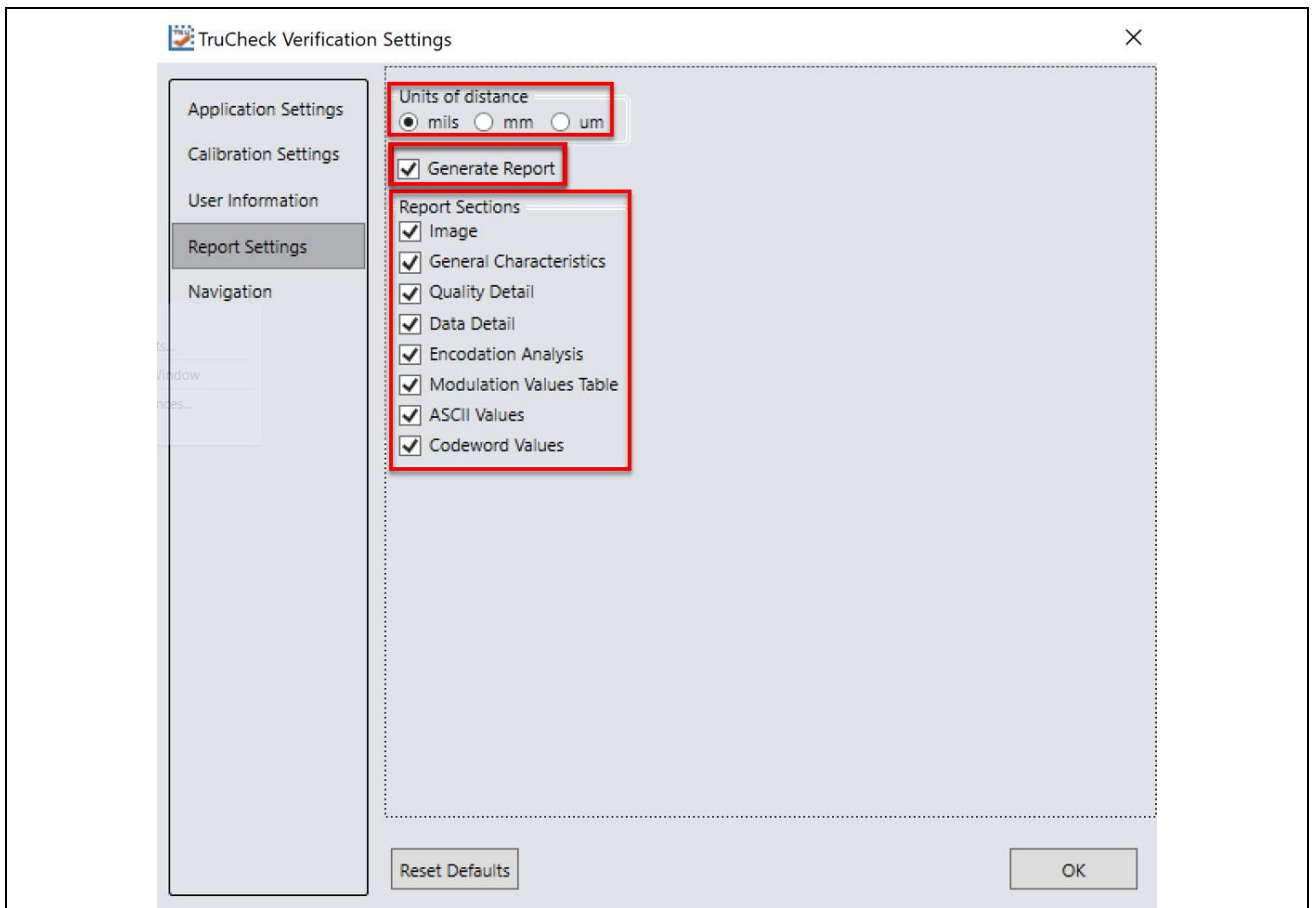

Element	Description
Units of distance	Select a unit of measurement for reporting X-Dimension. You can choose: <ul style="list-style-type: none"> • mils (thousandths of an inch) • mm (millimeters) • μm (micrometers)
Generate Report	Check the Generate Report checkbox to allow generating reports.
Report Sections	Each checkbox under Report Sections controls whether a particular section is included in the report. If you uncheck a checkbox, the report becomes smaller.

Navigation

The **Navigation** menu allows you to access certain options in the DataMan Setup Tool window to configure exporting results through DataMan Setup Tool or FTP. The **Navigation** menu also provides a shortcut to enable or disable symbologies and to set up the verifier to verify multiple symbols in one verification. Click the **View** button to redirect to the settings of each reporting option in DataMan Setup Tool.

Note: The DataMan Setup Tool is programmed to stay on top of all your other windows. This means, when you open the TruCheck window, the main window of the DataMan Setup Tool covers the TruCheck window. Minimize the main window of the DataMan Setup Tool, so the DataMan Setup Tool does not interfere the TruCheck window. However, when you want to use the **Navigation** feature to get to a page in the main window of the DataMan Setup Tool, you have to maximize the DataMan Setup Tool window again. For more information on Setup Tool Panes, see the *Setup Tool Reference Manual*.

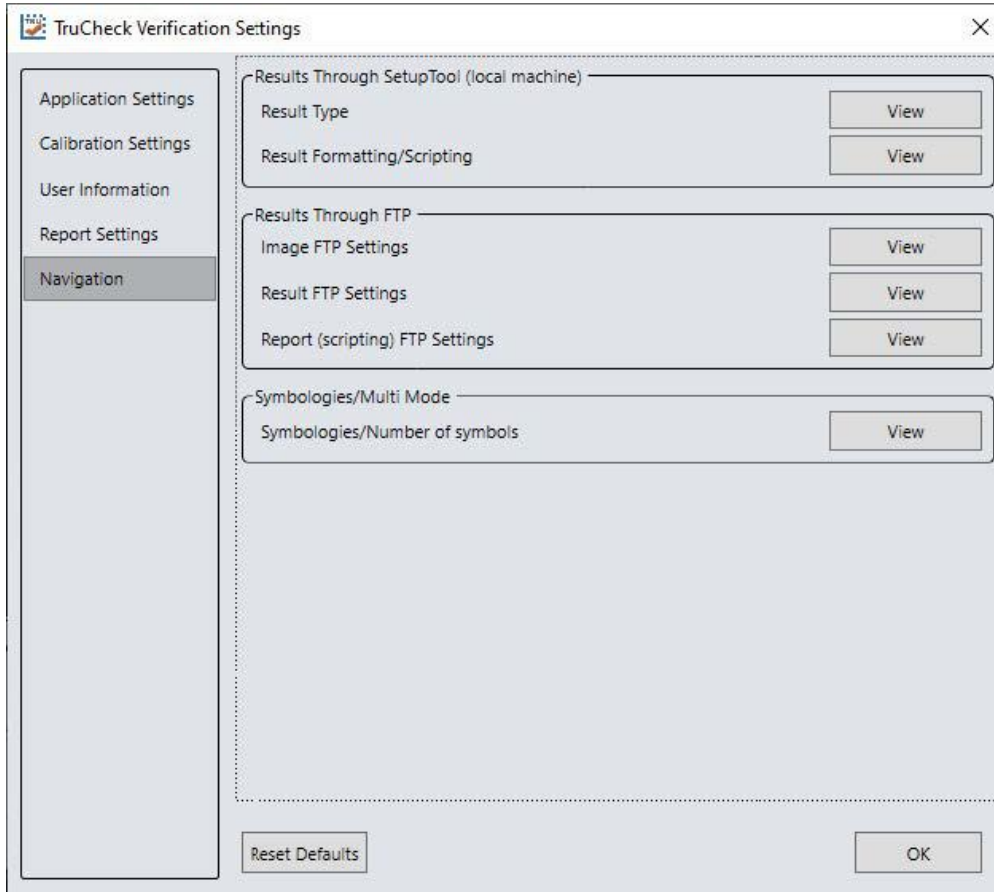

Result through Setup Tool (Local Machine)

In the **Results through Setup Tool (local machine)** section, the following options are available to navigate to the DataMan Setup Tool windows to set up a scripting menu for exporting verification results either as an HTML or CSV report:

- **Result Type:** Click **Result Type** to open the **Basic** tab in the **Format Data** application step in the DataMan Setup Tool. Select **Script-Based Formatting** to enable scripting for the export of verification data to CSV or to a custom, script-defined format.

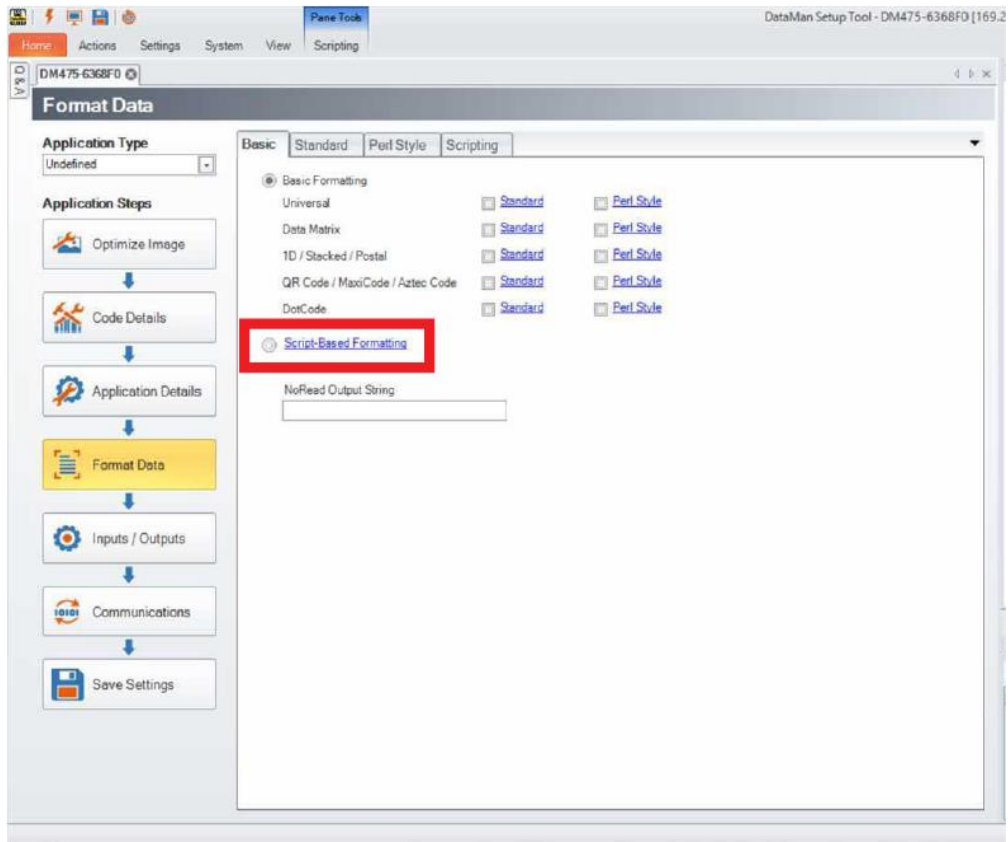

- **Result Formatting/Scripting:** Click **Result Formatting/Scripting** to open the **Scripting** tab in the **Format Data** application step in the DataMan Setup Tool. Create a script for outputting results or load a pre-written snippet in this window.

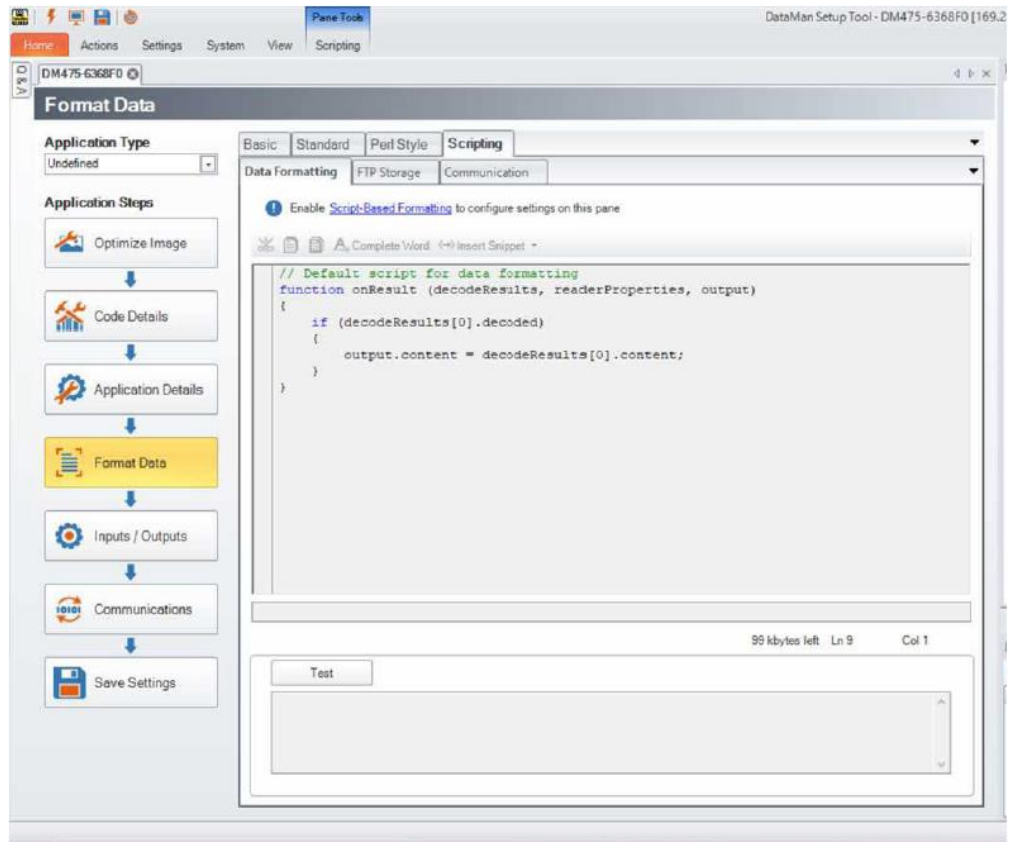

For more information on broad scripting options available in the DataMan Setup Tool, refer to the Scripting section of the *DataMan Communications & Programming Guide*.

Results through FTP

In the **Results through FTP** section, the following options are available to navigate to windows in the DataMan Setup Tool that connect to an FTP server for exporting verification:

- **Image FTP Settings:** Click **Image FTP Settings** to open the **Image Transfer** tab in the **Format Data** application step in the DataMan Setup Tool. Enter information in this window to set up image export through an FTP transfer.

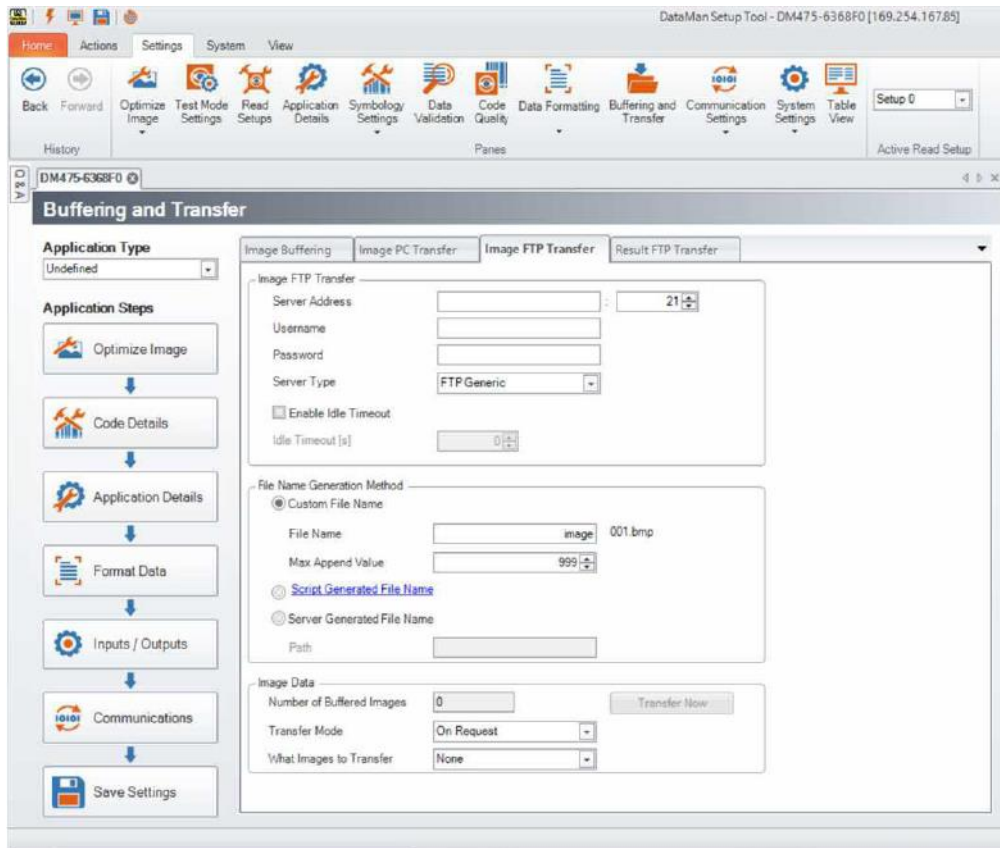

- **Result FTP Settings:** Click **Result FTP Settings** to open the **Result FTP Transfer** tab in the **Format Data** pane in the DataMan Setup Tool. Enter information in this window to export verification results through FTP transfer.

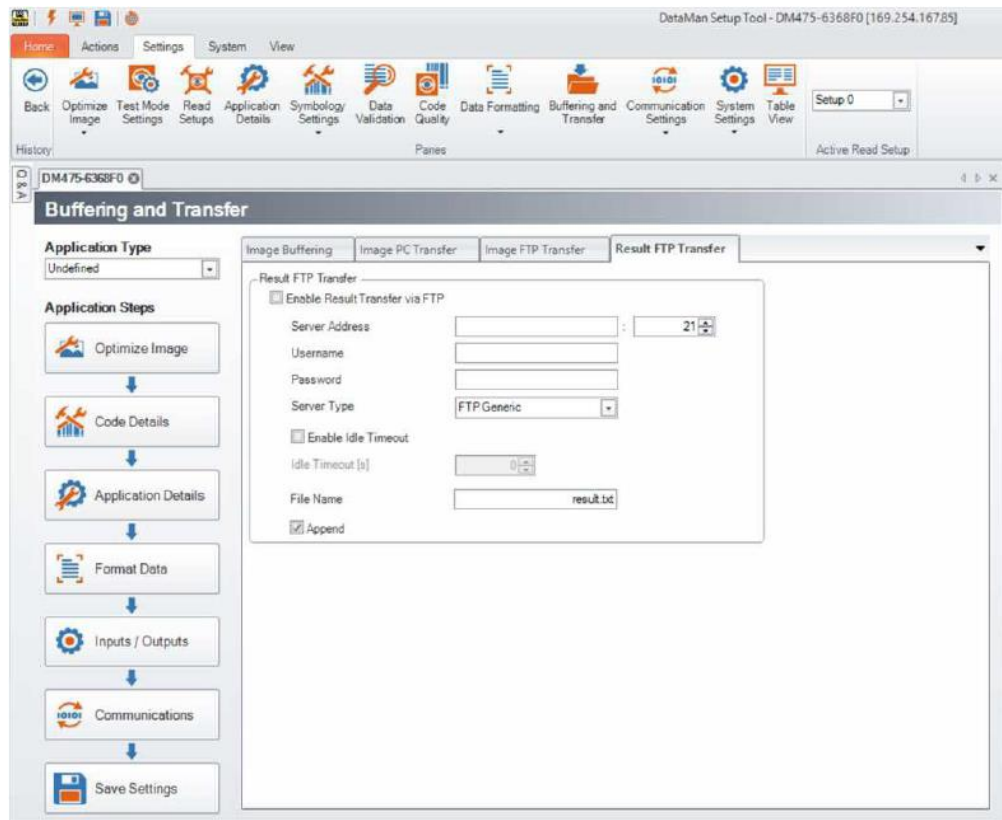

- **Report (scripting) FTP Settings:** Click **Report FTP Settings** to open the **Report FTP Transfer** tab in the **Code Quality** application step in the DataMan Setup Tool. Enter information in this window to export verification results through FTP transfer.

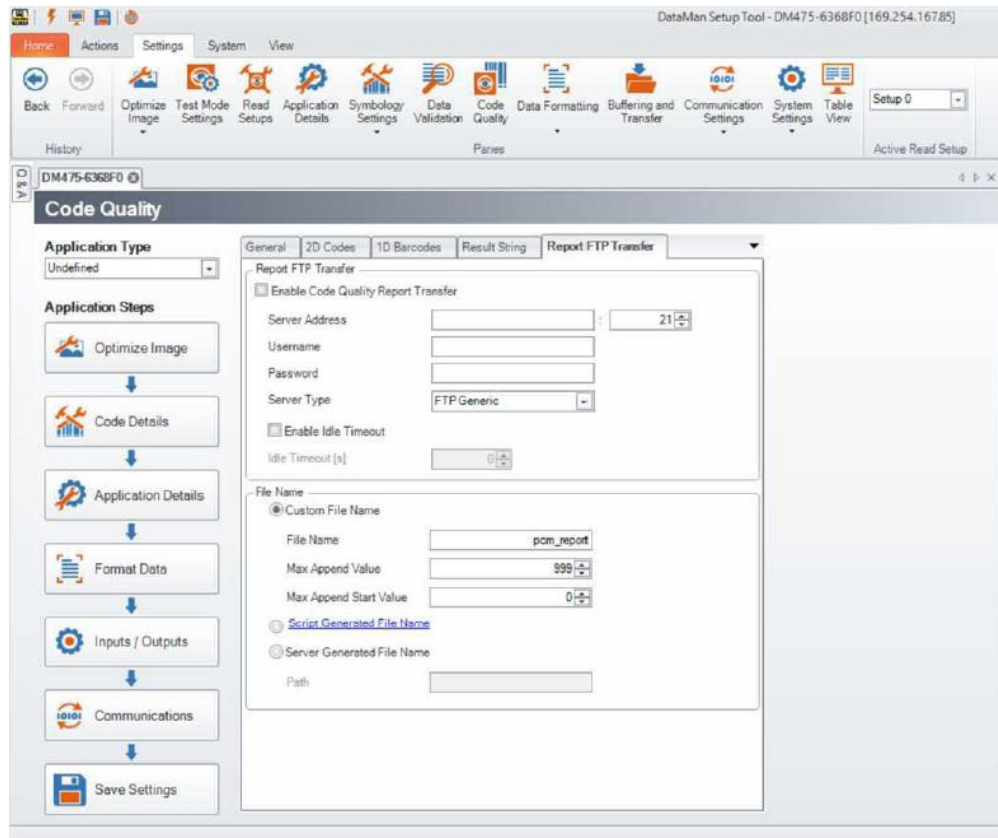

Cleaning/Maintenance

Cleaning the Verifier Housing

To clean the outside of the verifier housing, use a small amount of mild detergent cleaner or isopropyl alcohol on a cleaning cloth. Do not pour the cleaner on the verifier housing.

 **CAUTION:** Do not attempt to clean any DataMan product with harsh or corrosive solvents, including lye, methyl ethyl ketone (MEK) or gasoline.

Cleaning the Verifier Lens Cover

To remove dust from the lens cover, use a pressurized air duster. The air must be free of oil, moisture or other contaminants that could remain on the lens cover. To clean the plastic window of the lens cover, use a small amount of isopropyl alcohol on a cleaning cloth. Do not scratch the plastic window. Do not pour the alcohol on the plastic window.

Regulations and Conformity

The DataMan 8072 Verifier has Regulatory Model R00071, and meets or exceeds the requirements of all applicable standards organizations for safe operation. However, as with any electrical equipment, the best way to ensure safe operation is to operate them according to the agency guidelines that follow. Please read these guidelines carefully before using your device.

Note: For the most current CE and UKCA declaration and regulatory conformity information, see the Cognex support site: cognex.com/support.

Regulator	Specification
USA	FCC Part 15B, Class A
Canada	ICES-003, Class A
European Community	CE, Class A EN55032 EN55024
Japan	VCCI-3/2015.04 CISPR 22 Class A
Korea	KN32/KN35

The following table shows Safety and Regulatory Information for corded verifiers:

Safety and Regulatory	
Manufacturer	Cognex Corporation One Vision Drive Natick, MA 01760 USA
CE	This is a class A product. In a domestic environment this product may cause radio interference in which case the user may be required to take immediate measures. This equipment complies with the essential requirements of the EU Directive 2014/30/EU. Declarations are available from your local representative.
EU RoHS	Compliant to the most recent applicable directive.
FCC	FCC Part 15, Class A This equipment has been tested and found to comply with the limits for a Class A digital device, pursuant to part 15 of the FCC Rules. These limits are designed to provide reasonable protection against harmful interference when the equipment is operated in a commercial environment. This equipment generates, uses, and can radiate radio frequency energy and, if not installed and used in accordance with the instruction manual, may cause harmful interference to radio communications. Operation of this equipment in a residential area is likely to cause harmful interference in which case the user will be required to correct the interference at his own expense.
Canadian Compliance	This Class A digital apparatus complies with Canadian ICES-003. Cet appareil numérique de la classe A est conforme à la norme NMB-003 du Canada.
TÜV	DataMan 8072V: Regulatory Model R00071 NRTL: TÜV SÜD SCC/NRTL OSHA Scheme for UL/CAN 61010-1. CB report available upon request. TÜV SÜD, IEC/EN 61010-1.

The following table shows Safety and Regulatory Information for wireless verifiers:

LED Safety Statement

CAUTION: Illumination and Lens assembly: This device has been tested in accordance with IEC 62471-1:2008 and has been certified to the limits of Risk Group 2. Possibly hazardous optical radiation emitted from this product. Do not stare at the operating lamp. May be harmful to the eyes.

Laser Safety Statement

WARNING: Complies with FDA performance standards for laser products except for deviations pursuant to Laser Notice No. 50, dated June 24, 2007. This device has been tested in accordance with IEC60825-1 3rd ed., and has been certified to be under the limits of a Class 2 Laser device.



中国大陆RoHS (Information for China RoHS Compliance)

根据中国大陆《电子信息产品污染控制管理办法》(也称为中国大陆RoHS), 以下部份列出了本产品中可能包含的有毒有害物质或元素的名称和含量。



Table of toxic and hazardous substances/elements and their content, as required by China's management methods for controlling pollution by electronic information products.

Part Name 部件名称	Hazardous Substances 有害物质					
	Lead (Pb) 铅	Mercury (Hg) 汞	Cadmium (Cd) 镉	Hexavalent Chromium (Cr (VI)) 六价铬	Polybrominated biphenyls (PBB) 多溴联苯	Polybrominated diphenyl ethers (PBDE) 多溴二苯醚
Regulatory Model R00071	X	O	O	O	O	O

This table is prepared in accordance with the provisions of SJ/T 11364.

这个标签是根据SJ/T 11364 的规定准备的。

O: Indicates that said hazardous substance contained in all of the homogeneous materials for this part is below the limit requirement of GB / T26572 - 2011.

表示本部件所有均质材料中含有的有害物质低于GB / T26572 - 2011 的限量要求。

X: Indicates that said hazardous substance contained in at least one of the homogeneous materials used for this part is above the limit requirement of GB / T26572 - 2011.

表示用于本部件的至少一种均质材料中所含的危害物质超过GB / T26572 - 2011 的限制要求。

Precautions

⚠ WARNING: LASER LIGHT, DO NOT STARE INTO BEAM: CLASS 2 LASER PRODUCT. FAILURE TO FOLLOW THESE INSTRUCTIONS MAY CAUSE SERIOUS INJURY.

To reduce the risk of injury or equipment damage, observe the following precautions when you install the Cognex product:

- This product is intended for industrial use in automated manufacturing or similar applications.
- The safety of any system incorporating this product is the responsibility of the assembler of the system.
- This product does not contain user-serviceable parts. Do not make electrical or mechanical modifications to product components. Unauthorized modifications can void your warranty.
- Route cables and wires away from high-current wiring or high-voltage power sources to reduce the risk of damage or malfunction from the following causes: over-voltage, line noise, electrostatic discharge (ESD), power surges, or other irregularities in the power supply.
- Changes or modifications not expressly approved by the party responsible for regulatory compliance could void the user's authority to operate the equipment.
- Ensure that the cable bend radius begins at least six inches from the connector. Cable shielding can be degraded or cables can be damaged or wear out faster if a service loop or bend radius is tighter than 10X the cable diameter.
- This device should be used in accordance with the instructions in this manual.
- All specifications are for reference purposes only and can change without notice.
- This product is intended for industrial use in automated manufacturing or similar applications.
- The safety of any system incorporating this product is the responsibility of the assembler of the system.
- This product does not contain user-serviceable parts. Do not make electrical or mechanical modifications to product components. Unauthorized modifications can void your warranty.

