

## Deluxe I/O Box Quick Reference Guide



2024 December 20  
Revision: 25.1.0.3

# Symbols

The following symbols indicate safety precautions and supplemental information:



**WARNING:** This symbol indicates a hazard that could cause death, serious personal injury or electrical shock.

---



**CAUTION:** This symbol indicates a hazard that could result in property damage.

---



**Note:** This symbol indicates additional information about a subject.

---



**Tip:** This symbol indicates suggestions and shortcuts that might not otherwise be apparent.

---

# Precautions

To reduce the risk of injury or equipment damage, observe the following precautions when you install the Cognex product:

- Route cables and wires away from high-current wiring or high-voltage power sources to reduce the risk of damage or malfunction from the following causes: over-voltage, line noise, electrostatic discharge (ESD), power surges, or other irregularities in the power supply.
- Changes or modifications not expressly approved by the party responsible for regulatory compliance could void the user's authority to operate the equipment.
- Ensure that the cable bend radius begins at least six inches from the connector. Cable shielding can be degraded or cables can be damaged or wear out faster if a service loop or bend radius is tighter than 10X the cable diameter.
- This device should be used in accordance with the instructions in this manual.
- All specifications are for reference purposes only and can change without notice.

## About the Deluxe I/O Box



The Deluxe I/O Box provides power point to support up to four camera units and allows these the possibility to easily connect to their industrial environment.

The Deluxe I/O Box supports the DataMan 260, DataMan 300 series, DataMan 360 series, DataMan 370 series, DataMan 470 series readers and the DataMan 503 reader, together with the option of using external illumination with these readers.

### Additional Features:

- 110/240 AC/DC power supply to power multiple readers, external lights, and the internal electronics (for more information on power supply, see the table in *Power Requirements* on page 5)
- The I/O Box is able to source four external Barlights. This requires that the I/O Box be powered by a proper 24V supply (for more information, see the table in *Power Requirements* on page 5)



**Note:** Make sure that you connect external lights only to the light power sockets. Do not connect them to the output power.

# Power Requirements

The following table lists the power requirements based on the number of the different cameras and external lights you can use together with one or multiple Deluxe I/O Boxes.





**i Note:** This chart outlines power requirements only. Take into consideration all aspects of the application before choosing a power supply.

Power requirements (mA)										
Number of cameras	1	2	3	4	5	6	7	8	9	10
DM370 / 470 Series HPIA	800	1600	2400	3200	4000	4800	5600	6400	7200	8000
DM370 / 470 Series FOVE	800	1600	2400	3200	4000	4800	5600	6400	7200	8000
DM503 HPIA	1250	2500	3750	5000	6250	7500	8750	10000	11250	12500
DM503 Xpand15	1100	2200	3300	4400	5500	6600	7700	8800	9900	11000
DM503 XPand25	2600	5200	7800	10400	13000	15600	18200	20800	23400	26000

Color Key	
Single-camera I/O Box	
Deluxe I/O Box	

Color Key	
2 Deluxe I/O Boxes	Orange
10-Camera Panel	Red

# Cables

I/O extension and power cable, 5m straight	CKR-200-CBL-EXT	
Ethernet M12 to RJ45 cable	CCB-84901-y00x-xx (y straight/angled, x-xx specifies length)	
X-Coded to A-Coded Ethernet cable adapter, 0.5m <sup>1</sup>	CCB-M12X8MS-XCAC	
X-Coded to RJ45 Ethernet Cable 2	CCB-84901-2001-xx*	

---

<sup>1</sup> For DataMan 370 and 470 Series readers

<sup>2</sup> For DataMan 370 and 470 Series readers

# Deluxe I/O Box Layout

The following images show the layout of the Deluxe I/O box.

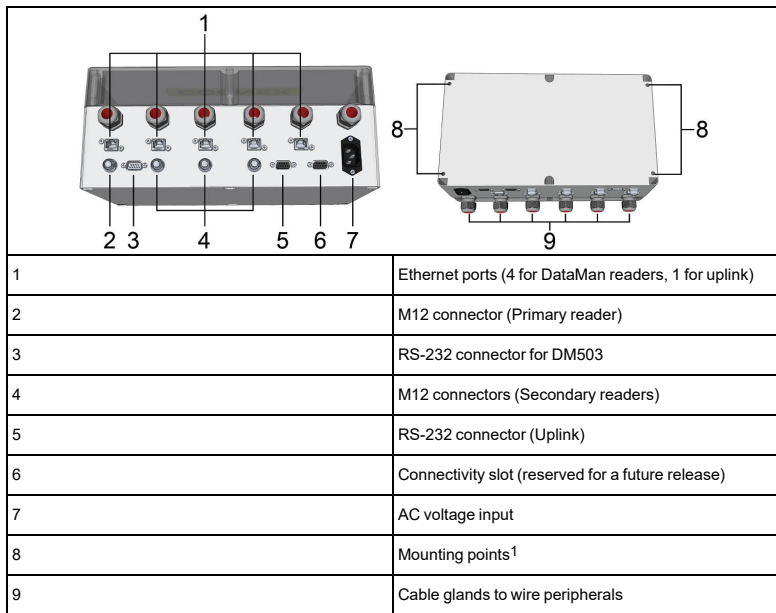

<sup>1</sup> Use M6 screws for mounting.

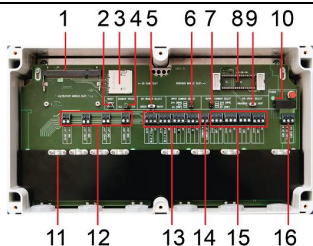

1	Extension module slot (reserved for a future release)
2	Reset switch
3	SD card slot (reserved for a future release)
4	Common trigger
5	Reader select switch (DM3xx/503)
6	NPN/EXT/PNP switch (Input)
7	NPN/EXT/PNP switch (Output)
8	Connectivity module slot (reserved for a future release)
9	Connectivity switch
10	Power indicator
11	Metal clamps (connecting the shielding of the cables)
12	Illumination power outputs

13	Input terminals
14	Common input and output terminal
15	Output terminals
16	24V supply screw terminal

# Dimensions

Observe the following dimensions when installing your Deluxe I/O Box:

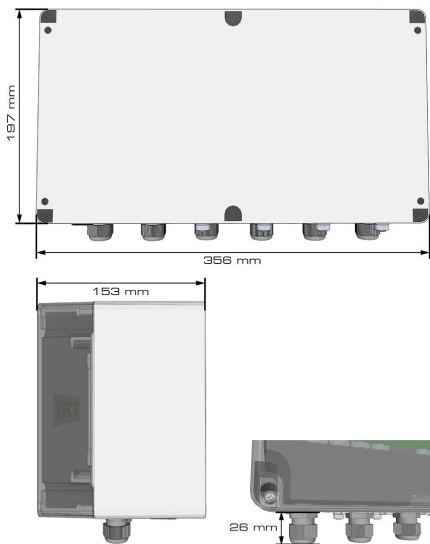

**Tip:** Always leave enough space below the box to avoid the pinching or bending of the cables leaving the cable glands.

# Mounting Instructions

The following factors must be observed when mounting the Deluxe I/O Box:

- Always use a flat and solid surface, and use all four mounting holes for maximum safety.
- Use M6 screws for mounting the Deluxe I/O Box to a mounting frame.
- Observe safety regulations when mounting the unit.
- Make sure that the cable glands are pointing downwards.
- Make sure that the Deluxe I/O Box is always accessible and not blocked by other equipment.
- Always leave enough space below the box to avoid the pinching or bending of the cables leaving the cable glands.
- Make sure that the Deluxe I/O Box is mounted in a clean and dry environment.

# Specifications

Weight	3.43 kg
Operating Temperature	0°C — 40°C (32°F — 104°F)
Storage Temperature	-10°C — 60°C (-14°F — 140°F)
Maximum Humidity	95% (non-condensing)
Environmental Protection	IP40
Power Supply	110V to 240V AC 50Hz/60Hz
Input Rating	110V to 240V AC, 50Hz/60Hz, 151W Or 24V DC (+/-10%), 240W
Output Rating	24V DC normal input/output: 0.2A (fused) light output: 2.6A (fused) overall: 6.3A when AC supplied 24V, 10A max when DC supplied

## Cleaning and Maintenance

To clean the outside of the housing of the Deluxe I/O Box, use a small amount of mild detergent cleaner or isopropyl alcohol on a cleaning cloth. Do not pour the cleaner directly onto the housing.

# Connecting Cameras

This section highlights the steps needed to safely connect a camera to the Deluxe I/O Box.

1. Make sure that the Deluxe I/O Box is unpowered, and remove the front cover by removing the six screws.

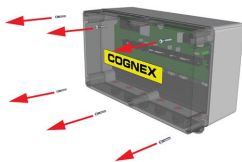

2. Set the following switches and triggers properly for your devices: Common trigger, Reader select switch, and the Input and Output common jumpers.

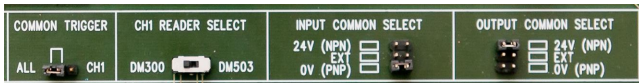

3. If you are using trigger wiring, unscrew the cable gland cover, pluck out the plastic cover, and thread in the trigger wire. Then screw the cover tightly and use the metal clamps to secure the cables.

**Note:**



- Make sure that the cable is secured tightly in the cable gland.
- Make sure that you use double insulated, shielded solid or stranded wires AWG-14 to AWG-22 with flammability rating of at least VW-1.

4. Insert the wire ends to the proper Input/Output terminal depending on your setup, then secure them using a flat head screwdriver.

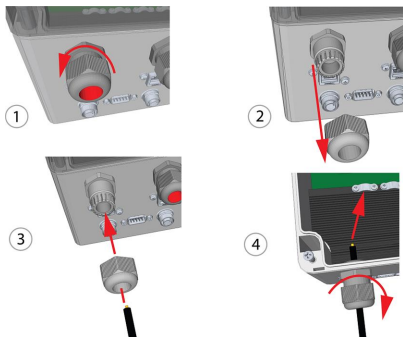

- Reattach the front cover.

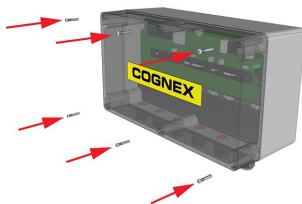

- Connect your camera(s) using the CKR-200-CBL-EXT extension cable. Optionally, the DM300, DM370 and DM470 series readers can be connected via Ethernet, while the DM503 can also be connected via Ethernet and RS-232 connectors. Connect either the RS-232 uplink or the Ethernet uplink to the network you are going to use in these optional cases.

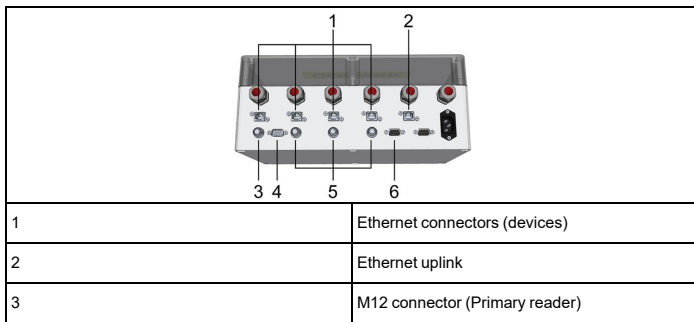

4	RS-232 connector (DM503)
5	M12 connectors (Secondary readers)
6	RS-232 uplink

## Connecting External Lights

When you connect external lights to the Deluxe I/O Box, always use 24V DC power and GND from the illumination outputs block. Do not use 24V DC power from the 24V DC terminal block for I/Os.

The following image illustrates where the Illumination Power Outputs are, together with the other sockets.

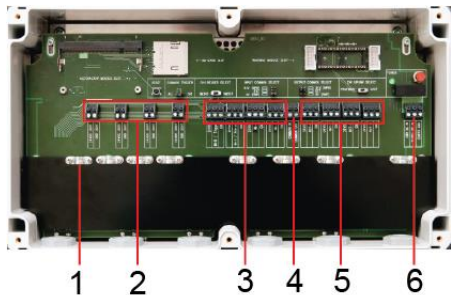

1	Metal clamps (connecting the shielding of the cables)
---	---

2	Illumination Power Outputs
3	Input terminals
4	Common Input and Output terminals
5	Output terminals
6	24V supply screw terminal

Use the illumination power outputs to provide power to external lights. Maximum current is 2.6A.

The 24V DC output on these terminals can only be used to power low current devices such as sensors and encoders. Maximum current is 0.2A.

All power outputs are secured by resettable fuses.

# Trigger Wiring

Trigger wiring is a common way to send input into **Input\_0** to a reader. You can power up the reader using the M12 connector, and you can use trigger wiring to have the reader start reading at a specified trigger.

The image below presents an example of trigger wiring.

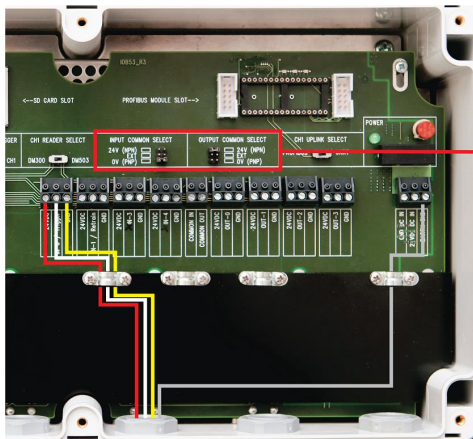

Wire colors:

- 24VDC
- IN 0 Trigger
- Ground
- Earth Ground



**Note:** Ensure that the Input Common jumper matches the wiring style of the trigger.

## Connecting 24VDC External Power (Optional)

**i** **Note:** Make sure that you use double insulated solid or stranded wires AWG-14 with flammability rating of at least VW-1.



### **Functional Earth (FE):**

The functional earth is used for interference suppression. It is a low-impedance current path between the circuitry and earth and is only used to improve the equipment's performance and not for protective purposes.

Make sure that 24VDC, GND and Earth are all connected:

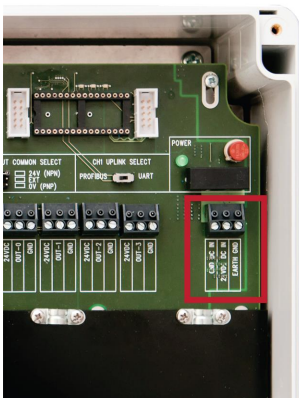

**CAUTION:** Make sure that functional ground is connected.



**WARNING:** Make sure that the wires are not connected to the supply during installation.

# Replacing Fuses

**i Note:** When replacing fuses, first disconnect the Deluxe I/O Box from mains and/or the supplied 24VDC.

The following fuse types are installed in the Deluxe I/O box:

- **10 A Fuse:** A Bel Fuse Type 5SF protecting the externally powered 24V/10A circuit.

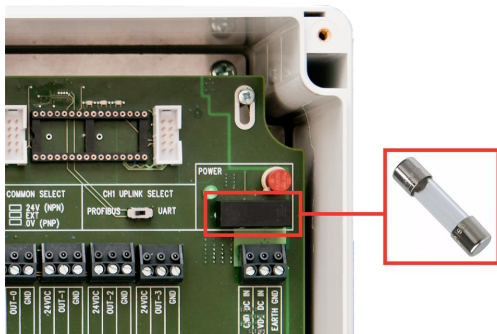

To replace this fuse, pull out the black fuseholder by picking it at the short sides. Remove the old fuse, assemble a new one, then push the fuseholder back into the socket.

- **6.3 A Fuse:** A Littelfuse 370 series TR5 fuse protecting the circuitry powered by internal power supply.

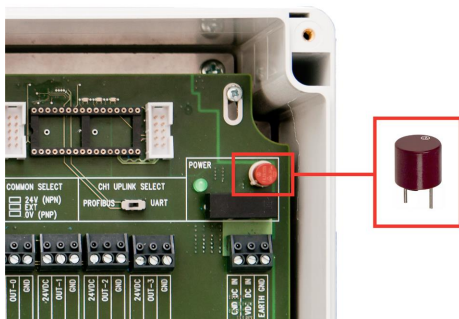

To replace this fuse, gently pull out the old one, and also gently push a new one into its place.

# Regulations/Conformity



**Note:** For the most current CE and UKCA declaration and regulatory conformity information, see the Cognex support site: [cognex.com/support](http://cognex.com/support).

The Deluxe I/O Box has Regulatory Model 1AAV, and meets or exceeds the requirements of all applicable standards organizations for safe operation. However, as with any electrical equipment, the best way to ensure safe operation is to operate it according to the agency guidelines that follow. Please read these guidelines carefully before using your device.

Safety and Regulatory	
Manufacturer	Cognex Corporation One Vision Drive Natick, MA 01760 USA
FCC	FCC Part 15, Class A This equipment has been tested and found to comply with the limits for a Class A digital device, pursuant to part 15 of the FCC Rules. These limits are designed to provide reasonable protection against harmful interference when the equipment is operated in a commercial environment. This equipment generates, uses, and can radiate radio frequency energy and, if not installed and used in accordance with the instruction manual, may cause harmful interference to radio communications. Operation of this equipment in a residential area is likely to cause harmful interference in which case the user will be required to correct the interference at his own expense.
Canada	ICES-003, Class A This Class A digital apparatus complies with Canadian ICES-003. Cet appareil numérique de la classe A est conforme à la norme NMB-003 du Canada.

Copyright © 2020  
Cognex Corporation. All Rights Reserved.