

DataMan[®] 360 Series Reference Manual



2024 December 20
Revision: 25.1.0.9

Legal Notices

The software described in this document is furnished under license, and may be used or copied only in accordance with the terms of such license and with the inclusion of the copyright notice shown on this page. Neither the software, this document, nor any copies thereof may be provided to, or otherwise made available to, anyone other than the licensee. Title to, and ownership of, this software remains with Cognex Corporation or its licensor. Cognex Corporation assumes no responsibility for the use or reliability of its software on equipment that is not supplied by Cognex Corporation. Cognex Corporation makes no warranties, either express or implied, regarding the described software, its merchantability, non-infringement or its fitness for any particular purpose.

The information in this document is subject to change without notice and should not be construed as a commitment by Cognex Corporation. Cognex Corporation is not responsible for any errors that may be present in either this document or the associated software.

Companies, names, and data used in examples herein are fictitious unless otherwise noted. No part of this document may be reproduced or transmitted in any form or by any means, electronic or mechanical, for any purpose, nor transferred to any other media or language without the written permission of Cognex Corporation.

Copyright © 2025. Cognex Corporation. All Rights Reserved.

Portions of the hardware and software provided by Cognex may be covered by one or more U.S. and foreign patents, as well as pending U.S. and foreign patents listed on the Cognex web site at: cognex.com/patents.

The following are registered trademarks of Cognex Corporation:

Cognex, 2DMAX, Advantage, AlignPlus, Assemblyplus, Check it with Checker, Checker, Cognex Vision for Industry, Cognex VSOC, CVL, DataMan, DisplayInspect, DVT, EasyBuilder, Hotbars, IDMax, In-Sight, Laser Killer, MVS-8000, OmniView, PatFind, PatFlex, PatInspect, PatMax, PatQuick, SensorView, SmartView, SmartAdvisor, SmartLearn, UltraLight, Vision Solutions, VisionPro, VisionView

The following are trademarks of Cognex Corporation:

The Cognex logo, 1DMax, 3D-Locate, 3DMax, BGAll, CheckPoint, Cognex VSoC, CVC-1000, FFD, iLearn, In-Sight (design insignia with cross-hairs), In-Sight 2000, InspectEdge, Inspection Designer, MVS, NotchMax, OCRMax, PatMax RedLine, ProofRead, SmartSync, ProfilePlus, SmartDisplay, SmartSystem, SMD4, VisiFlex, Xpand

Portions copyright © Microsoft Corporation. All rights reserved.

Portions copyright © MadCap Software, Inc. All rights reserved.

Other product and company trademarks identified herein are the trademarks of their respective owners.

Table of Contents

Legal Notices	2
Table of Contents	3
Symbols	5
Getting Started	6
About the DataMan 360 Reader	6
Supporting Documentation	6
DataMan 360 Series Accessories	7
Lens Options	7
Lens Covers	8
External Lights (Red LED)	9
Laser Aimers	10
High Power Illumination Accessories	10
Cables	11
Power Supplies	12
Mounting Brackets	12
DataMan 360 Systems	13
Setting Up Your DataMan 360 Reader	14
Reader Layout	14
Dimensions	16
Installing the Lens	18
Installing an M12 Lens with Manual Focus	18
Installing a Liquid Lens	20
Installing the 24 mm Liquid Lens Module with DM360-HPIL-RE-01 or DM360-HPIL-RE-P-01	22
Installing a C-Mount Lens	24
Connecting External Illumination to DataMan 360	27
Single Light	27
Multiple Lights	27
Installing a Filter	29
External Light Mounting Brackets	33
Setting Focus	35
Liquid Lens	35
Manual Focus Lens	37
Focus Feedback	37
Best Practices	38
Field of View and Reading Distances	39
Reading Distance and Field of View (DataMan 360 Readers with a 10.3 mm Liquid Lens)	39
Reading Distance and Field of View (DataMan 360 Readers with a 16 mm Lens)	40
Reading Distance and Field of View (DataMan 360 Readers with a 19 mm Lens with a Liquid Lens)	41
Reading Distance and Field of View (DataMan 360 Readers with a 24 mm Lens with Liquid Lens)	42
Reading Distance and Field of View (DataMan 360 Readers with a 25 mm Lens)	43
DataMan 360 Series Specifications	45
DataMan 360 Series Imager Specifications	46
LED Wavelengths	46

Illumination Options	47
Using Your DataMan 360 Reader	49
Installing DataMan Software and Connecting the Reader	49
Troubleshooting an Ethernet Connection	49
Industrial Protocols	50
DataMan 360 Series Triggering	50
External Triggers	52
DataMan 360 Series Multi-Reader Sync Option	53
DataMan 360 Series Tuning	54
DataMan 360 Series Image Filtering	56
Training the Reader	57
Training Feedback	57
Incremental Training for Multiple Symbologies	58
Package Detection Support	58
Connections, Optics, and Lighting	60
External Light Control (CCB-M12XFLY-05)	60
5 m Breakout Cable (CCBL-05-01)	61
5m Breakout Cable (CCB-M12x12Fy-xx)	62
15m Breakout Cable (CCB-PWRIO-15)	63
High-Speed Outputs	64
High-Speed Output Wiring	65
5m RS-232 Connection Cable (CCB-M12XDB9Y-05)	66
Ethernet M12 to RJ45 Cable (CCB-84901-y00x-xx)	67
Acquisition Trigger	67
Connecting the Encoder to a DataMan Reader	68
Multi-Port Connections	68
Cleaning and Maintenance	71
Cleaning the Reader Housing	71
Cleaning the Reader Lens Cover	71
Compliance Information, Warnings and Notices	72
Precautions	72
Regulations and Conformity	72
Laser Safety Statement	73
LED Safety Statement	74
For European Community Users	74
Reader Programming Codes	74

Symbols

The following symbols indicate safety precautions and supplemental information:

 **WARNING:** This symbol indicates a hazard that could cause death, serious personal injury or electrical shock.

 **CAUTION:** This symbol indicates a hazard that could result in property damage.

 **Note:** This symbol indicates additional information about a subject.

 **Tip:** This symbol indicates suggestions and shortcuts that might not otherwise be apparent.

Getting Started

This section provides general information about the DataMan 360 series reader and the DataMan 360 accessories and systems.

About the DataMan 360 Reader



The DataMan 360 series readers are high-performance, fixed-mount ID readers that offer:

- Highest Read Rates on 1-D and 2-D codes
- Most flexible optics and lighting
- Intelligent tuning and express setup

The DataMan 360 series readers provide advanced Ethernet connectivity, support for serial RS-232 and discrete I/O, and advanced options for lighting and optics.

The DataMan 360 series readers are packaged in a rugged, IP-rated housing, and provide numerous ease-of-use features, including one button to trigger and one to start tuning.

Supporting Documentation





This document provides basic information about the DataMan 360 series readers. Additional information is available through the Windows **Start** menu or the DataMan Setup Tool **Help** menu after you install the DataMan software on your PC:







- The **DataMan Communications and Programming Guide** shows you how to integrate your DataMan reader into your particular automation and factory environment.
Cognex->DataMan Software v x.x.x->Documentation->Communications->DataMan Communications and Programming Guide
- The **DataMan Industrial Protocols Manual** provides information on how to integrate DataMan reader into your particular environment using industrial protocols.
Cognex->DataMan Software v x.x.x->Documentation->Communications->DataMan Industrial Protocols Manual
- The **DataMan Reader Configuration Codes** document provides printable 2-D codes that you can use to configure the DataMan reader.
Cognex->DataMan Software v x.x.x->Documentation->English->Reader Configuration Codes
- The **DM360 Quick Reference Guide** provides essential information about the DM360 reader.
Cognex->DataMan Software v x.x.x->Documentation->English->DM360 Series->DM360 Quick Reference Guide

- The **DataMan Fixed-Mount Readers Reference** is a complete online hardware reference for the DataMan fixed-mount ID reader.
Cognex->DataMan Software v x.x.x->Documentation->English->DM360 ->Fixed-Mount Reference Manual
- The **DataMan Questions and Answers** document provides context-sensitive information. You can view this help inside the DataMan Setup Tool or as a stand-alone help file.
Cognex->DataMan Software v x.x.x->Documentation->DM360->Questions and Answers
- The **DataMan Control Commands** lists DataMan Control Commands with all relevant information. You can view this help inside the Setup Tool or as a stand-alone help file.
Cognex->DataMan Software v x.x.x->Documentation->English->DataMan Control Commands
- The **Setup Tool Reference Manual** describes the user interface of the DataMan Setup Tool software.
Cognex->DataMan Software v x.x.x->Documentation->English->Setup Tool Reference Manual
- The **Release Notes** list detailed system requirements and additional information about this DataMan software release.
Cognex->DataMan Software v x.x.x->Documentation->DataMan v x.x.x Release Notes

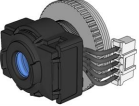
DataMan 360 Series Accessories

Lens Options

Accessory	Product Number	Illustration
10.3 mm M12 lens with locking* and 10.3 mm IR M12 lens with locking**	DM300-LENS-10 DM300-LENS-10-IR	
Liquid lens module and pre-focused 10.3 mm IR M12 lens with wrench** Liquid lens module and pre-focused 10.3 mm M12 lens with wrench*	DM300-LENS-10LL- IR DM300-LENS-10LL	
19 mm liquid lens module*	DM300-LENS-19LL	
8 mm F5.6 fixed aperture lens 12 mm F8 fixed aperture lens 16 mm F8 fixed aperture lens 16 mm F11 fixed aperture lens 25 mm F8 fixed aperture lens 25 mm F11 fixed aperture lens 35 mm F8 fixed aperture lens 35 mm F11 fixed aperture lens	LEC-CFF08-F5.6 LEC-CFF16-F8 LEC-CFF16-F11 LEC-CFF25-F8 LEC-CFF25-F11 LEC-CFF35-F8 LEC-CFF35-F11	





Accessory	Product Number	Illustration
24 mm F6 liquid lens module*	DM360-LENS-24LL	
16 mm M12 lens with locking**	DM300-LENS-16	
25 mm M12 lens with lens spacer and hex wrench (also requires Extension kit)**	DM300-LENS-25	
Extension kit	DM300-EXT	
DM500 C-Mount cover	DM500-CMTLC-000	
DM500 Lens cover extender	DM500-LNSEXT-000	

* With built-in IR blocking filter

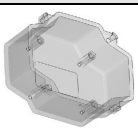
** Without built-in IR blocking filter



Lens Covers

Accessory	Product Number	Illustration
Clear lens cover	DM300-CLCOV	

Accessory	Product Number	Illustration
Clear lens cover with white LED illumination (Risk Group Exempt acc. IEC 62471)	DM300-CLCOV-WHI	
Diffuse lens cover with red LED illumination (Risk Group Exempt acc. IEC 62471)	DM300-DLCOV-RE	
Diffuse lens cover with blue LED illumination (Risk Group Exempt acc. IEC 62471)	DM300-DLCOV-BL	
Diffuse lens cover with IR LED illumination (Risk Group Exempt acc. IEC 62471)	DM300-DLCOV-IR	
Polarized lens cover with red LED illumination (Risk Group Exempt acc. IEC 62471)	DM300-PLCOV-RE	
Red LED high power integrated light, 10.3 mm lens (Risk Group Red LED Exempt acc. IEC 62471, Risk Group Green LED Aimer Exempt acc. IEC 62471)	DM360-HPIL-RE	
Polarized red LED high power integrated light, ESD safe, 10.3 mm lens (Risk Group Red LED Exempt acc. IEC 62471, Risk Group Green LED Aimer Exempt acc. IEC 62471)	DM360-HPIL-RE-P	
White LED high power integrated light, 10.3 mm lens (Risk Group white LED low risk acc. IEC 62471, Risk Group Green LED Aimer Exempt acc. IEC 62471)	DM360-HPIL-WHI	
Red LED high power integrated light, 24 mm lens (Risk Group Red LED Exempt acc. IEC 62471)	DMLT-HPIL-RE	
Polarized red LED high power integrated light, 24 mm lens (Risk Group Green LED Aimer Exempt acc. IEC 62471)	DMLT-HPIL-RE-P	
White LED high power integrated light, 24 mm lens (Risk Group white LED low risk acc. IEC 62471, Risk Group Green LED Aimer Exempt acc. IEC 62471)	DMLT-HPIL-WHI	
C-Mount cover for C-Mount lenses	DM300-CMCOV	
Short C-Mount cover for C-Mount lenses	DM300-CMCOV-SH	

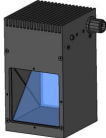
External Lights (Red LED)

Accessory	Product Number	Illustration
Coaxial (DOAL) light	CLRO-K5050G1	

Accessory	Product Number	Illustration
Spot light	CLRS-P14G1	
Bar light, blue	IVSL-LX520-470	
Bar light, red	IVSL-LX520-625	

Laser Aimers

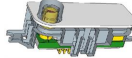
Accessory	Product Number	Illustration
Laser aimer	DM300-AIMER-00	

High Power Illumination Accessories







Accessory	Product Number	Illustration
HPIA, red narrow	DM30X-HPIA3-625	
HPIA, red wide	DM30X-HPIA3-625-W	
HPIA, white narrow	DM30X-HPIA3-WHI	
HPIA, white wide	DM30X-HPIA3-WHI-W	
HPIA, blue narrow	DM30X-HPIA3-470	
HPIA, blue wide	DM30X-HPIA3-470-W	
HPIA, infrared narrow	DM30X-HPIA3-IR	
HPIA, infrared wide	DM30X-HPIA3-IR-W	

Note:

- If using the following Cognex high power illumination lights with a DM30X-HPIA-xxx product ID:
 - A spacer kit accessory (DMA-SPKIT-30X-00) is required when using the high power illumination accessory. When the spacer is used, the field of view will be limited for wide-angled lenses.
 - A Fair-Rite ferrite (part number 0431167281) must be attached to the External Light cable to reduce emissions.

Accessory	Product Number	Illustration
Red narrow	DM30X-HPIA-625	
Red wide	DM30X-HPIA-625-W	
Red narrow with polarizer	DM30X-HPIA-625P	
White narrow	DM30X-HPIA-WHI	
White wide	DM30X-HPIA-WHI-W	
Blue narrow	DM30X-HPIA-470	
Blue wide	DM30X-HPIA-470-W	
Infrared narrow	DM30X-HPIA-IR	
Infrared wide	DM30X-HPIA-IR-W	

Cables

Accessory	Product Number	Illustration
Connection cable 24V, I/O, RS-232 (y=S: straight / y=A: angled *, xx specifies length)	CCB-M12x12Fy-xx	
Connection cable 24V, I/O, RS-232	CCBL-05-01	
Power and I/O breakout cable, M12-12 (straight, xx specifies length: 5 m, 10 m, 15 m)	CCB-PWRIO-xx	
Power and I/O breakout cable, M12-12 (angled *, xx specifies length: 5 m, 10 m, 15 m)	CCB-PWRIO-xxR	
Connection cable RS-232	CCB-M12xDB9Y-05	
Power cable for multiple bar lights (use in combination with IVSL-5PM12-5)	CCB-FOV25-MAL012	
Ethernet M12 to RJ-45 cable (y=1: straight / y=6: angled, x-xx specifies length)	CCB-84901-y00x-xx	
External Light cable (xxx specifies length) Compatible only with CLRR / CLRB / CLRO / CLRS / CLRD illumination	CCB-M12x4MS-xxx	
External light control cable for DataMan, 5 meters in length with flying leads	CCB-M12XFLY-05	
Bar light cable (xxx specifies length: 300, 500, 1000, 2000 mm) Compatible with IVSL lights, except IVSL-LX280	IVSL-5PM12-Jxxx	
External Light cable (xx specifies length: 0.5 m, 1 m, 2 m, 5 m)	CCB-M12LTF-xx	
I/O extension cable, 5 m straight	CKR-200-CBL-EXT	

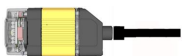

* DM360 with straight

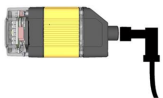

and angled cable



Power Supplies

Accessory	Product Number	Illustration
24V power supply	DMA-CCM-4X-xx ¹	
24V power supply	DMA-CCM-1-xx ²	

Mounting Brackets

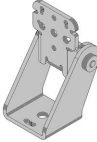
Accessory	Product Number	Illustration
Universal Mounting Bracket	DM100-UBRK-000	
Pivot Mounting Bracket	DM100-PIVOTM-01	

¹ xx can be EU, UK, or JP.

² xx can be US, EU, UK, or JP.

DataMan 360 Systems

	Omnidirectional 1-D Code Reading	1DMax+™ — Best-In-Class 1-D Reading	IDQuick™ — High-Speed 2DMax+™ Reading	2DMax+™ — for hard to read DPM and damaged 2-D PowerGrid™ codes	Multi-Reader Sync	Resolution
DataMan 360L (DMR-360L-00)		✓			✓	800x600
DataMan 360X (DMR-360X-00)	✓	✓	✓	✓	✓	
DataMan 362L (DMR-362L-00)		✓			✓	1280x1024
DataMan 362X (DMR-362X-00)	✓	✓	✓	✓	✓	
DataMan 333L (DMR-363L-00)		✓			✓	1600x1200
DataMan 363X (DMR-363X-00)	✓	✓	✓	✓	✓	

Setting Up Your DataMan 360 Reader

This section provides information on the physical appearance of the DataMan 360 Reader. It also details the steps of installing the lenses and filters of the reader, and gives information on the imager.

Reader Layout

The following image shows the built-in lighting system of the DataMan 360 series reader, underneath the plastic lighting cover, the mounting holes and the laser safety notice on the bottom of the reader.

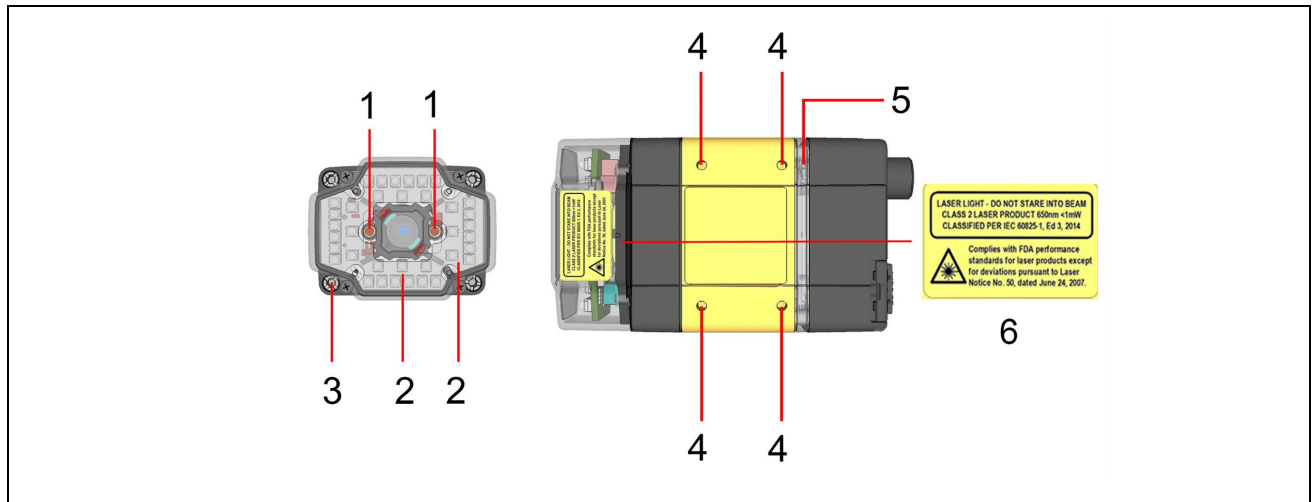

Number	Component
1	Laser aimer Can be enabled under Light and Imager Settings in the DataMan Setup Tool (disabled by default) to aid in aiming the lens
2	Illumination LED clusters
3	External illumination mounting point
4	Mounting holes (M3 x 5mm)
5	Light ring
6	Laser safety notice

The following image shows a detailed picture about the back cover and the functions of the indicator lights.

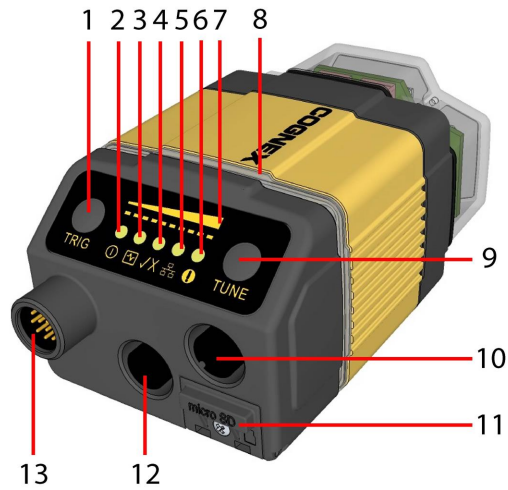

Number	Component
1	Trigger button
2	Power
3	Train status
4	Good/bad read
5	Network
6	Error
7	Peak meter
8	Indicator light ring
9	Tuning button
10	Ethernet
11	SD card slot
12	External light control
13	Power, I/O and RS232

Type	Signal	Color	Meaning
Status	Power	GREEN	Power ON
	Train status	GREEN	Trained
		YELLOW	Untrained
Error	RED	Error - check device log	
Action	Good/bad read	GREEN	Good read
		RED	Bad read
	Communication	YELLOW	Link up
		<i>blink</i>	Activity
Peak meter	-	Decode yield, train progress/quality	

Dimensions

Note:

- Dimensions are in millimeters [inches] and are for reference purposes only.
- All specifications are for reference purposes only and can change without notice.

Observe the following DataMan 360 series reader dimensions when installing your reader.

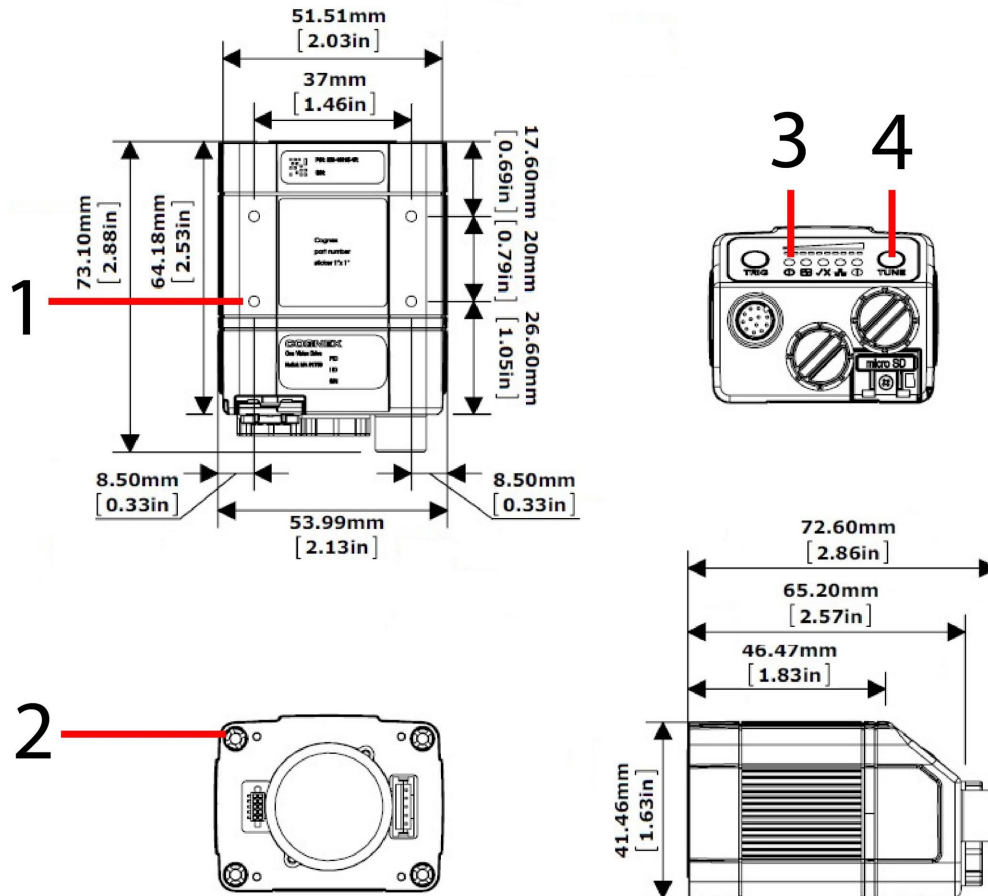

1	M3-5 (4x) mounting holes of the device
2	M3-6 (4x) mounting holes for external illumination
3	Indicator lights
4	Operating buttons

The following images show the DataMan 360 reader's dimensions without lens and with C-mount and S-mount lens options.

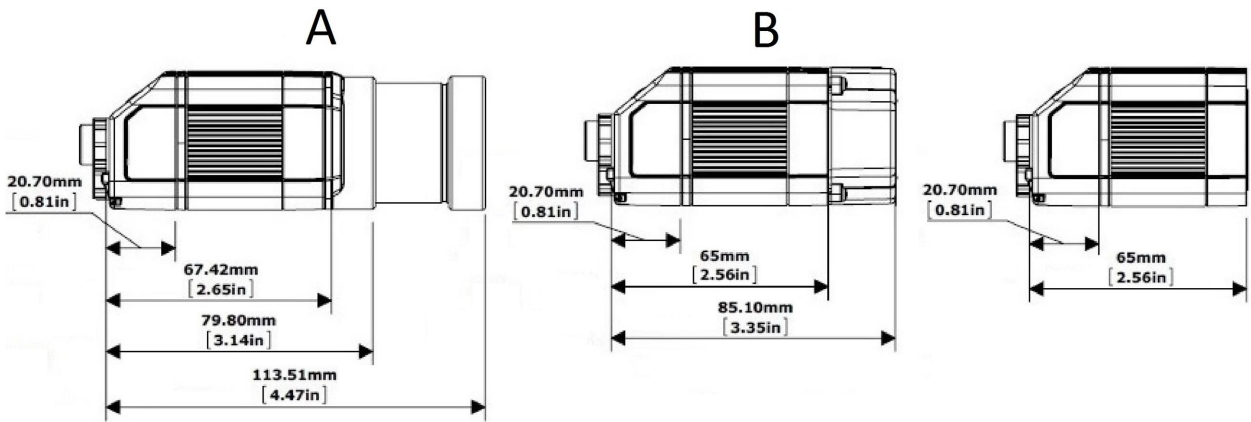

A	S-Mount (M12) Lens version
B	C-Mount Lens version

Installing the Lens

You can choose between a variety of different (High-Speed) Liquid Lenses and C-Mount lens options to be installed on your DataMan 360 series reader.

⚠ WARNING: Disconnect the DataMan 360 reader from power before installing the lens and light.

Installing an M12 Lens with Manual Focus

1. Remove the lens plug.

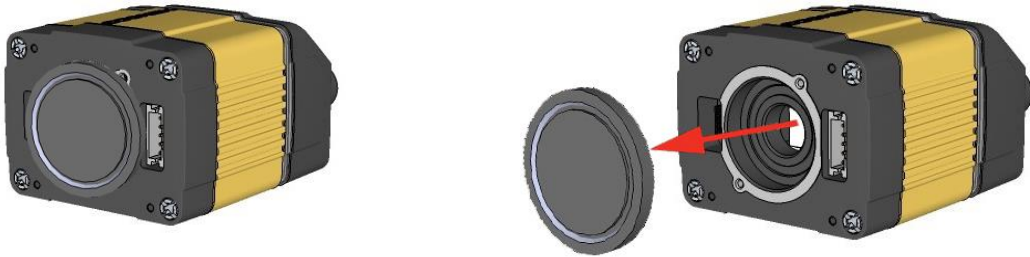

2. Thread the lens into the reader.



3. Press the rubber lens-locking cone into the reader. While carefully avoiding rotating the lens, press the rubber lens locking cone into the reader until it snaps into place around the nose of the lens.



4. Place the reader at the desired working distance from focus target.
 - a. Connect the reader to the DataMan Setup Tool.
 - b. Adjust your camera settings to make sure you have a brightened and high contrast image. On the **Optimize Image** page, check the **Focus Feedback** option from the drop-down menu of the **Live** button.
 - c. Use the DataMan Focus Target template, available through the Windows **Start** menu or the DataMan Setup Tool **Help** menu, to align the edge of the reader body to the line marked with the target distance used in your application.
 - d. Adjust focus for maximum sharpness. Enhance image quality in the DataMan Setup Tool for better guidance.

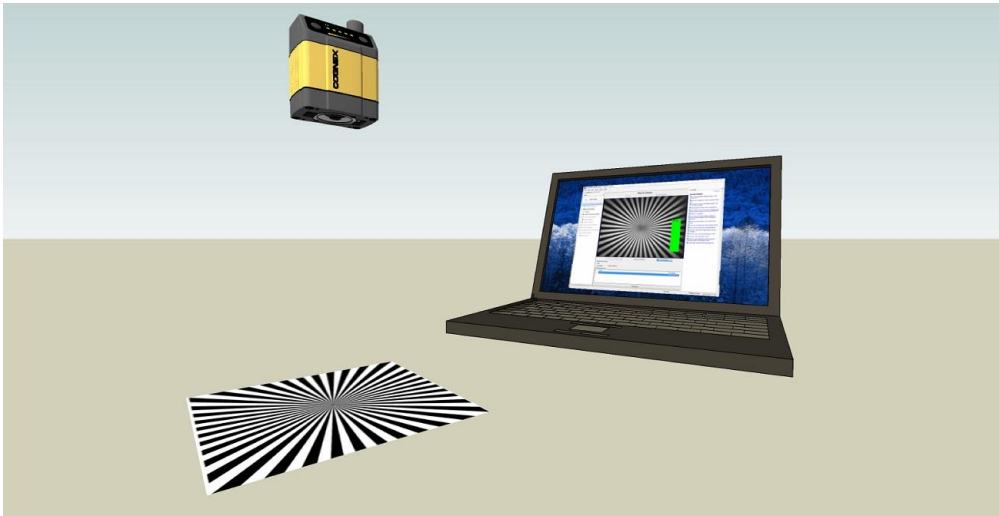

5. Tighten the lens.
After fixing the lens, verify focus position again, using the steps above.
6. Attach the front cover.

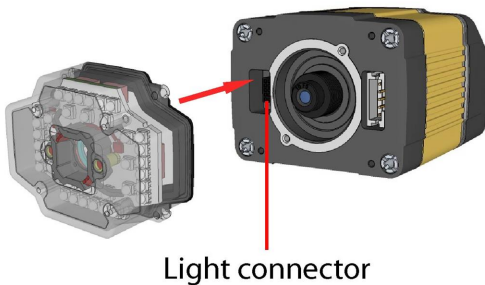

7. Insert and tighten the screws.

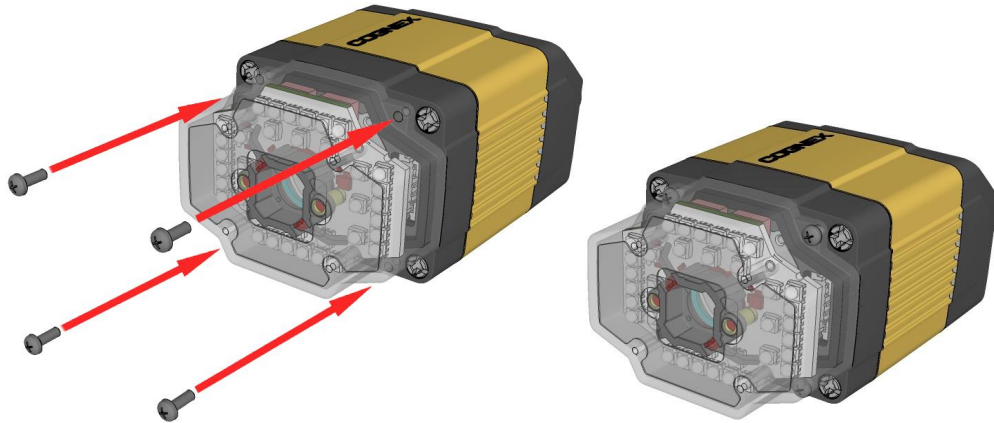

PHILLIPS PAN HEAD M2X6mm

Note: Tighten in sequence. Torque limit: 9 Ncm (0.8 in-lbs).

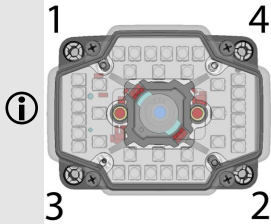

Note: Remove the protection film applied to the front cover before usage!

Installing a Liquid Lens

1. Remove the lens plug as described in [Installing The Lens](#).
2. Thread the lens into the reader.

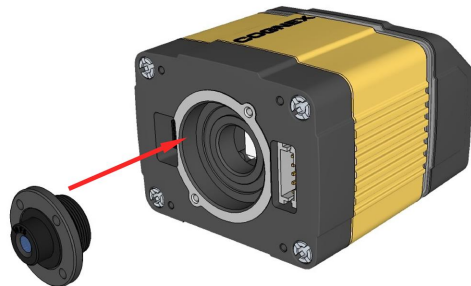

3. Tighten the locking ring.

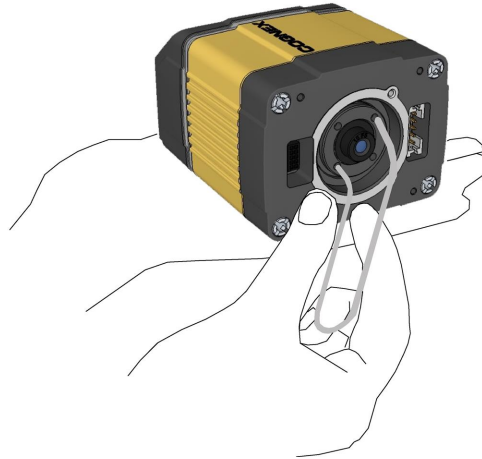

4. Connect the liquid lens cable to the reader.

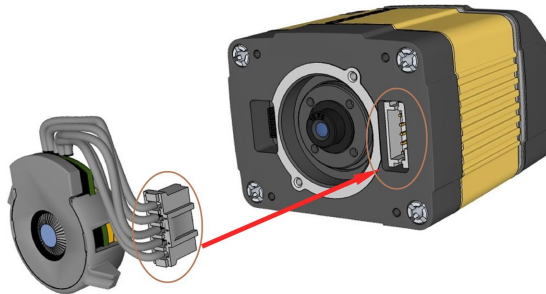

⚠ WARNING: To avoid equipment damage, the cables must be routed as shown in the figure.

5. Snap the liquid lens module onto the nose of the lens, making sure that it lies flat.



6. Place the reader at the desired working distance from focus target.
 - a. Connect the reader to the Setup Tool.
 - b. On the **Optimize Image** page, check the **Focus Feedback** option from the drop-down menu of the **Live** button.
 - c. Use the DataMan Focus Target template, available through the Windows **Start** menu or the Setup Tool **Help** menu, to align the edge of the reader body to the line marked with the target distance used in your application.
 - d. Adjust focus for maximum sharpness. Enhance image quality in the DataMan Setup Tool for better guidance.

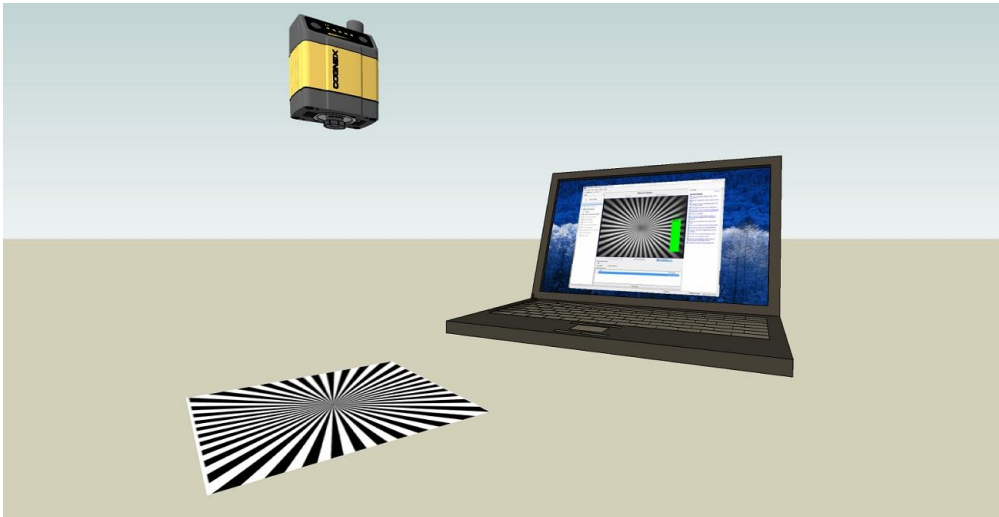

Installing the 24 mm Liquid Lens Module with DM360-HPIL-RE-01 or DM360-HPIL-RE-P-01

The possible hardware configurations using a 24 mm liquid lens module with a DataMan 360 series reader is the following:

- DM3xx-system + DM300-LENS-24LL + DM360-HPIL-RE-01 / DM360-HPIL-RE-P-01

To install a 24 mm liquid lens module of a DataMan 360series reader, perform the following steps:

⚠ WARNING: Disconnect the DataMan reader from power before continuing.

⚠ CAUTION: Do not leave the image sensor exposed to the environment.

1. Attach the **24 mm Lens** to the device by using the screw thread on the metal ring.



2. Insert the **Liquid Lens cable** into the connector of the device.



3. Attach the **Liquid Lens** to the front side of the **24mm Lens**.

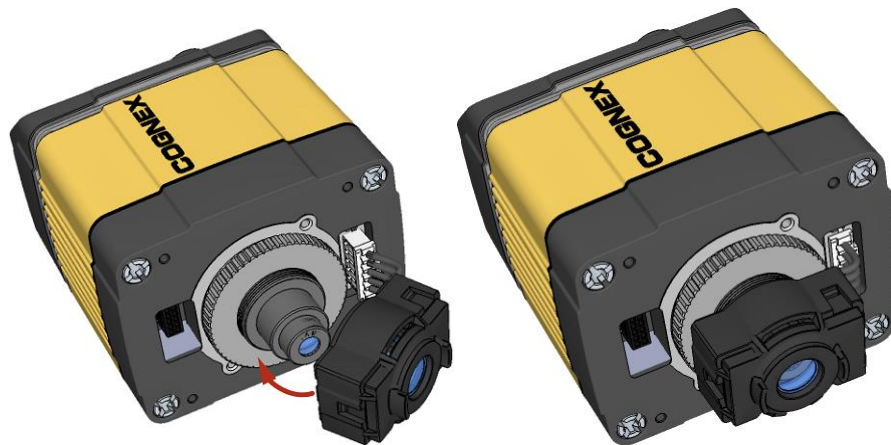

- Place the **DM360-HPIL-RE-01** or **DM360-HPIL-RE-P-01** unit on the front of the device.

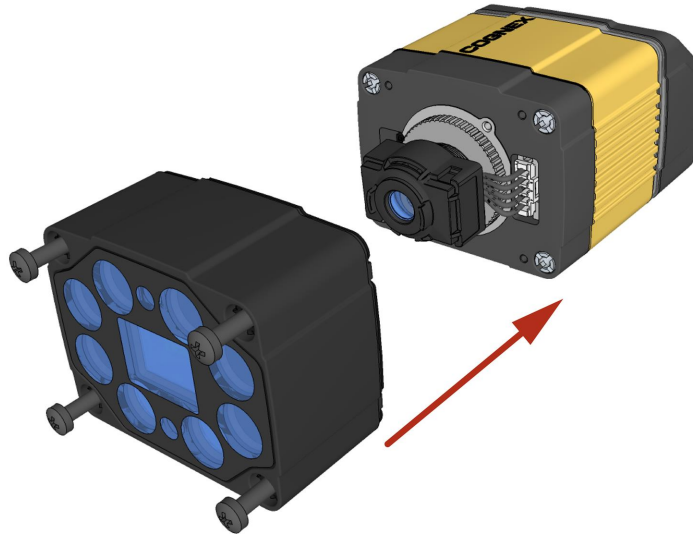

CUSTOMIZED CAPTIVE SCREW, PHILLIPS PAN HEAD, M3x28mm

Note: The minimum peak current capacity of the power supply for the device and the DM360-HPIL-RE-01 / DM360-HPIL-RE-P-01 is 2.2A per unit.

Note: The DM360-HPIL-RE-01 or DM360-HPIL-RE-P-01 is also compatible with the 10.3 mm Liquid Lens. For the 10.3 mm Liquid Lens, use CUSTOMIZED CAPTIVE SCREW, PHILLIPS PAN HEAD, M3x28mm.

- Screw in the four screws.

Note: Use 0.2 Nm torque on the screws and tighten in sequence.

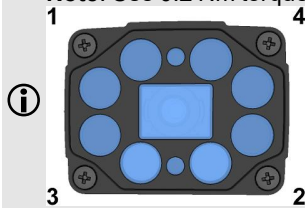

Installing a C-Mount Lens

- Remove the lens plug as described in [Installing the Lens](#).
- Thread the lens into the reader.



- Place the reader at the desired working distance from focus target.

Note: Make sure to set focus for the reader before fitting the lens cover.

- a. Connect the reader to the DataMan Setup Tool.
- b. Navigate to the **Optimize Image** pane, and on the **Basic** tab, click the triangle on the **Live** button to access the drop-down list, and check the **Focus Feedback** option. See [Setting Focus on page 35](#)
- c. Use the DataMan Focus Target template, available through the Windows **Start** menu or the DataMan Setup Tool **Help** menu, to align the edge of the reader body to the line marked with the target distance used in your application.
- d. Adjust focus for maximum sharpness. Enhance image quality in the DataMan Setup Tool for better guidance.

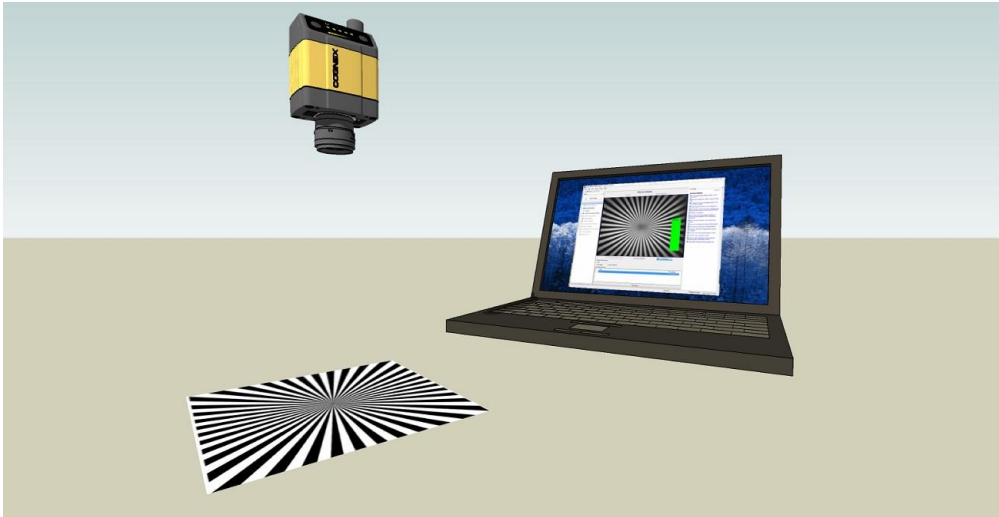

4. Attach the C-Mount cover base.



5. Add the screws to the C-Mount cover base.

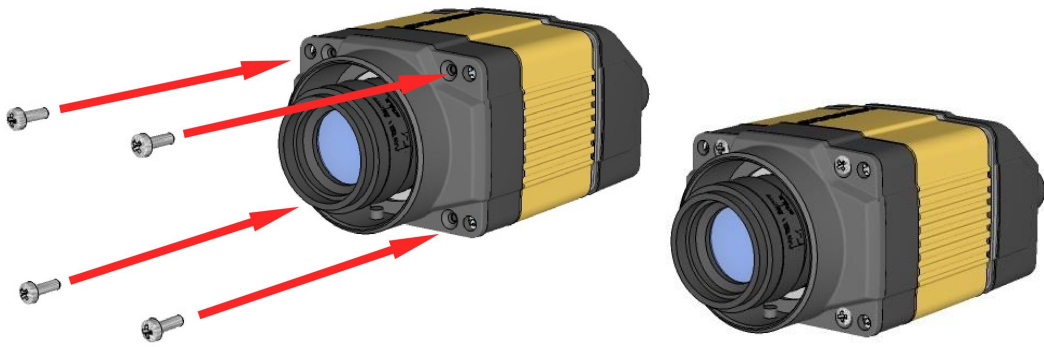

PHILLIPS PAN HEAD M2 X 6 mm

Note:

Tighten in sequence. Torque limit: 9 Ncm (0.8 in-lbs).

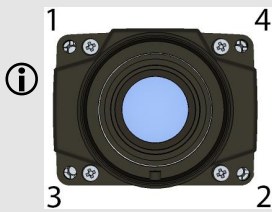

6. Attach the front cover.

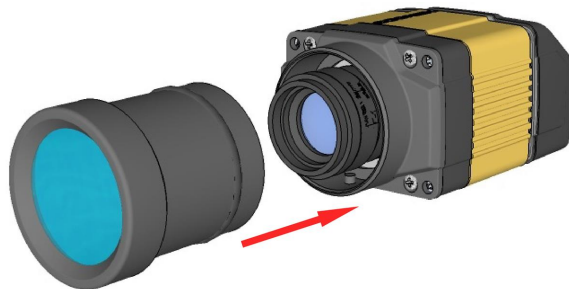

Note: Do not unscrew the front-most part of the nose of the cover to avoid risking the glass lens falling out.

7. Align the peg on the reader and the slot on the cover so that the cover locks in place.

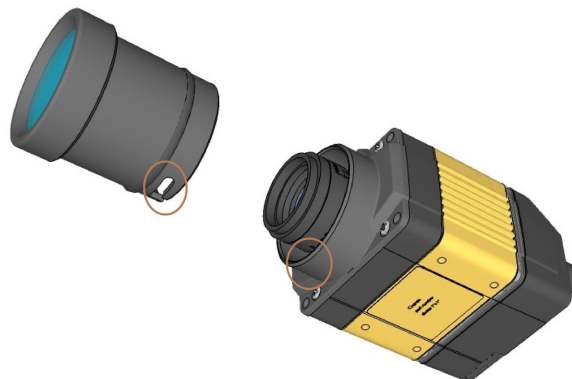

Connecting External Illumination to DataMan 360

You can connect the following external lights to the external light control port of the DataMan 360:

- Bar light (IVSL-YLW2X-xxx, IVSL-LX520-xxx)
- LX280-series light (IVSL-LX280-xxx)

Single Light

Note: The images show a DM470 series reader connected to the external lights, but you can connect external lights to a DM360, and DM370 series reader in the same way.

External light IVSL-YLW2X-xxx or IVSL-LX520-xxx connected to DM360 / DM370 / DM470:



External light IVSL-LX280-xxx connected to DM360 / DM370 / DM470:



Multiple Lights

Follow these steps to connect two or more bar lights (IVSL-YLW2X or IVSL-LX520-xxx):

1. Connect the lights with cable IVSL-5PM12-Jxxx.
2. Connect the light to the DM360 with cable CCB-FOV25-MAL-012.
3. Cut and isolate brown wire (24 VDC) and blue wire (GND) from cable IVSL-5PM12-5 connected to the other light.

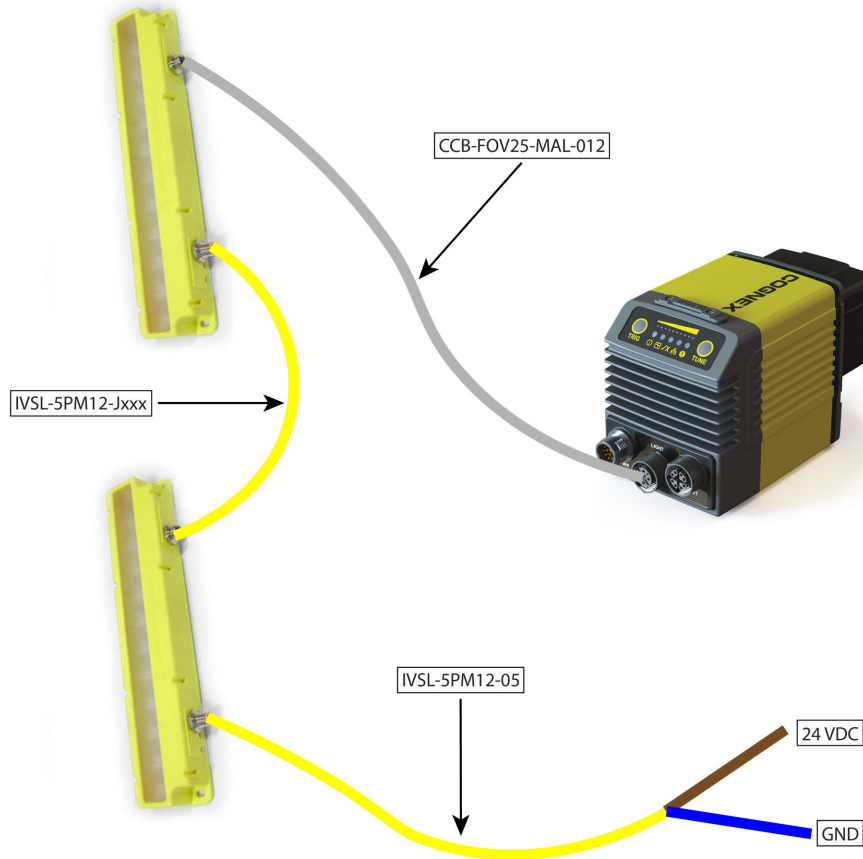

Follow these steps to connect two or more bar lights:

1. Create a panel where all cables come together
2. Connect the lights to the panel with cable IVSL-FSK-J5000
3. Connect the DM360 with cable CCB-M12XFLY-05

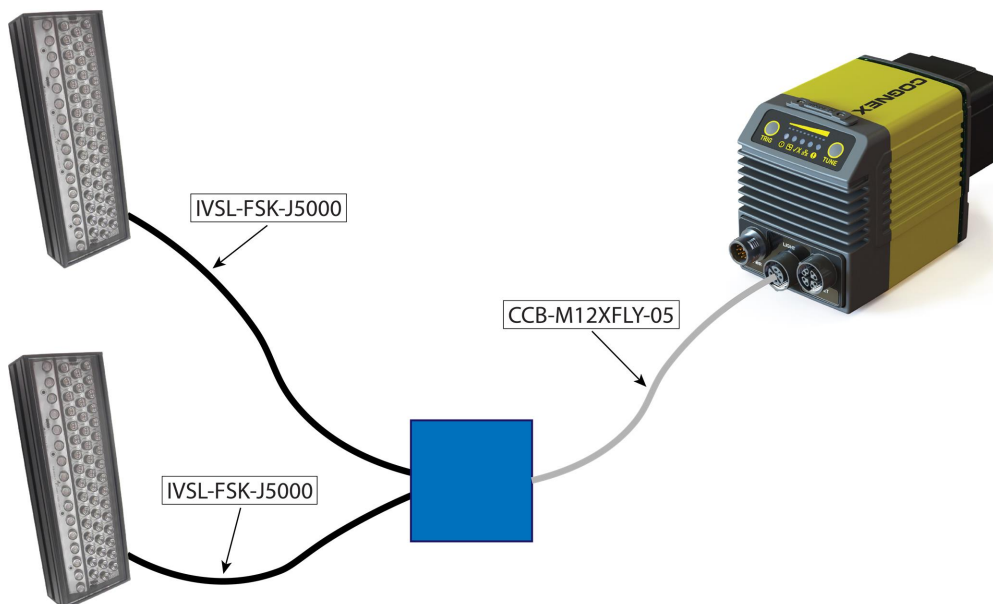

Inside the panel you need to:

1. Cut and isolate brown (24V) wire from CCB-M12XFLY-05
2. Cut M12 connector from IVSL-FSK-J5000
3. Strip open end from IVSL-FSK-J5000

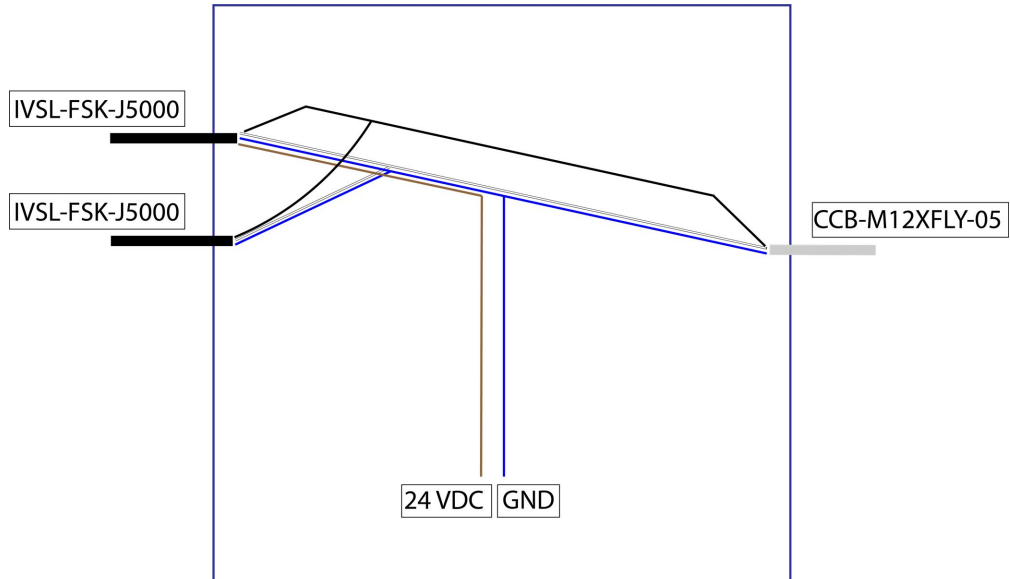

4. Connect all black wires together
5. Connect all white wires together
6. Connect all blue wires together
7. Connect brown wires from IVSL-FSK-J5000 together
 - Cut off brown wire from CCB-M12XFLY-05
8. Connect blue wires to GND
9. Connect brown wires to 24 VDC

Note: For more details on the External Light Control, see [External Light Control \(CCB-M12XFLY-05\) on page 60](#)

Installing a Filter

Perform the following steps to install an optical filter in the front cover.

Observe the following constraints on the filter:

- Diameter (\varnothing): $12.3\text{mm} < \varnothing < 12.7\text{mm}$
- Thickness (t): $1.6\text{mm} < t < 2\text{mm}$

1. First, remove the front cover: unscrew the four M3 screws and take off the LED cover.

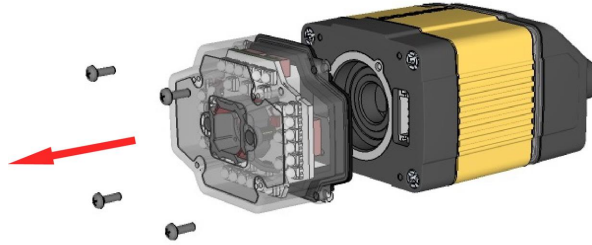

2. Take off the rubber seal, remove the two smaller screws, and remove the PCB.

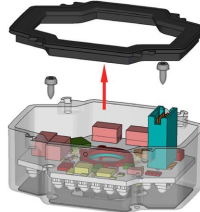

Note: Use a T6 Torx screwdriver.

WARNING: Make sure that no electrostatic charges are applied to the PCB. (For example, wear ESD shoes.)

3. Working from the front of the PCB, press the legs of the filter holder gently together and pull off the clip.

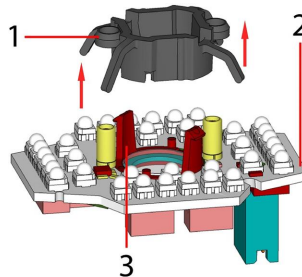

1	Filter retaining clip
2	LED PCB
3	Filter holder

4. Insert first the filter glass, then the soft spacer (which was removed from its place between the filter holder and the filter retaining clip) into the filter holder. A pair of tweezers may be helpful.

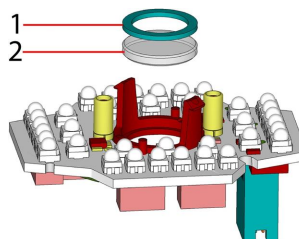

1	Soft spacer
2	Filter glass

5. Snap fit the filter retaining clip onto the legs of the filter holder. Ensure that the laser modules slide into the laser guides and the orientation pin fits into the filter retaining clip.

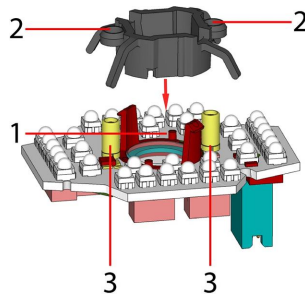

1	Orientation pin
2	Laser guide
3	Laser module

Check that the snap hooks are correctly positioned and fully engaged.

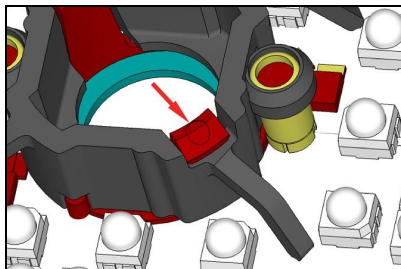

6. Insert the PCB with the filter retaining clip and the filter holder back into the front cover. Ensure that the hole in the PCB meets the orientation pin in the front cover. Fix the PCB with two Torx 6 screws of size 2.0x5 mm.

Note: Use a torque of 8-10Ncm (11-14 oz-in).

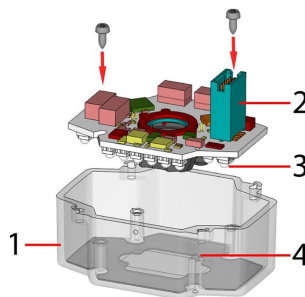

1	LED cover
2	PCB with filter holder and filter retaining clip
3	Notch in PCB
4	Orientation pin

7. Insert the rubber seal.

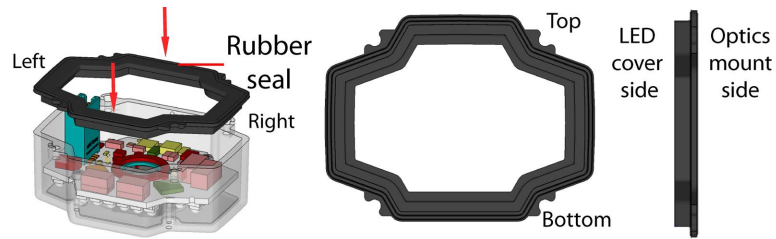

Note: The seal can only be installed in the correct orientation.

8. Remount the front cover. Observing the tightening sequence below, tighten all four screws to 9 Ncm using a torque wrench.

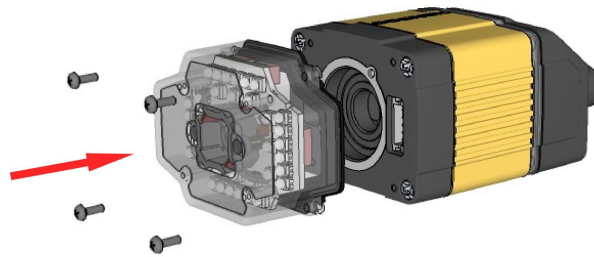

PHILLIPS PAN HEAD M2 X 6MM

Note: Tighten in sequence. Torque limit: 9 Ncm (0.8 in-lbs).

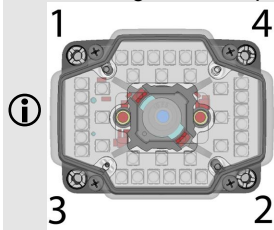

External Light Mounting Brackets

You can mount your reader using external light mounting brackets. The brackets are intended to mount any of the different lights to the reader. They can also be used to mount the reader (with lights attached) to your machine. Pivot mounting, as illustrated, is optional.

Perform the following steps to mount your reader with external mounting brackets in order to use the light options illustrated below:

1. Mount your reader on the camera plate and attach the screws.

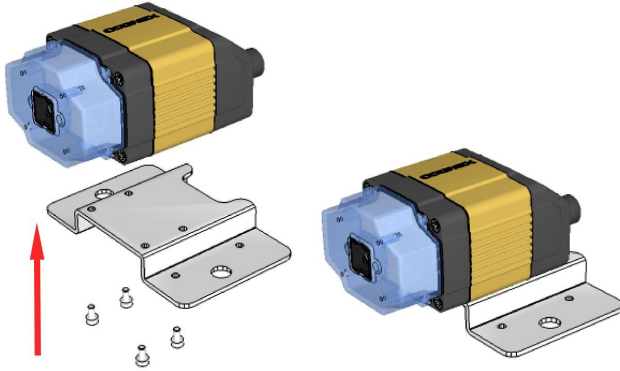

2. Mount your reader with the camera plate attached to any of the external light bracket adapters.

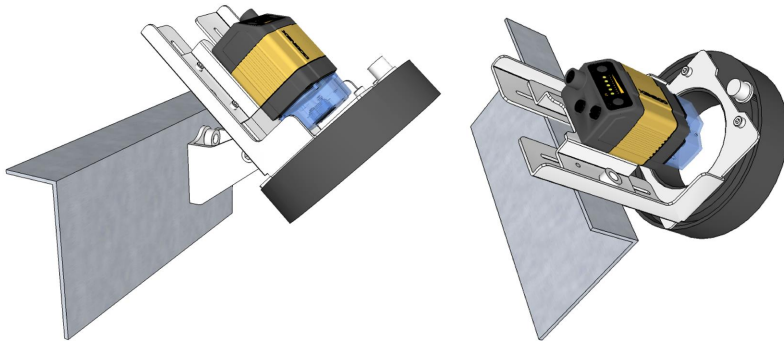

3. Choose one of the following light options:

Using coaxial (DOAL) light

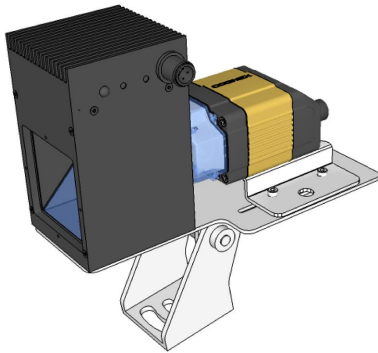

Using dark field light

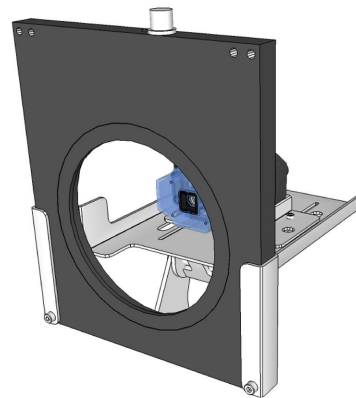

Using ring light

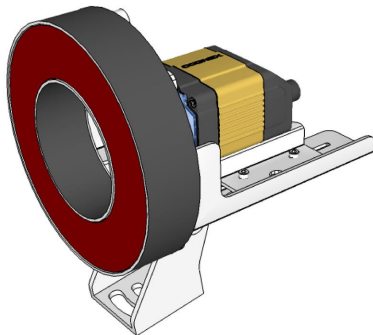

Using spot light

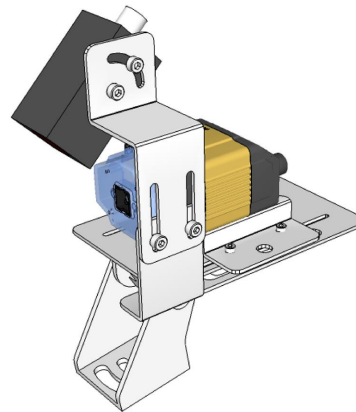

Setting Focus

There is a range of reading distances available for different code sizes and focus positions. To set focus on your reader, use the following options depending on whether you use a liquid lens or a manual focus lens.

DataMan readers are compatible with multiple different lenses. Each lens has a range of reading distances available for different code sizes and focus positions. Having accurate focus settings is essential to maximize read rates.

To set the focus on your reader, use the following options depending on whether you use a liquid lens or a manual focus lens.

Liquid Lens

1. Click the **Focus Feedback** button in the image panel in SetupTool to enable focus feedback. This enables a color-coded focus feedback bar on the right side of the image panel.

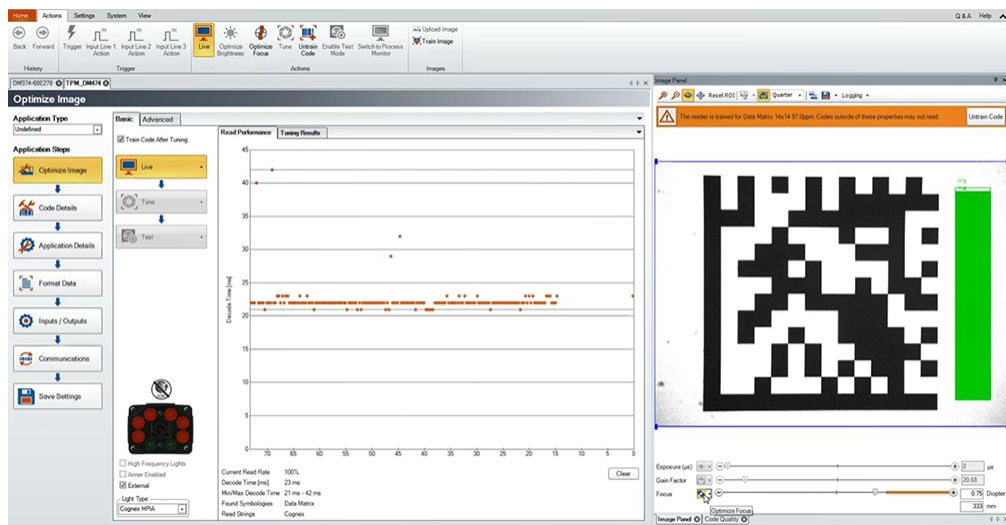
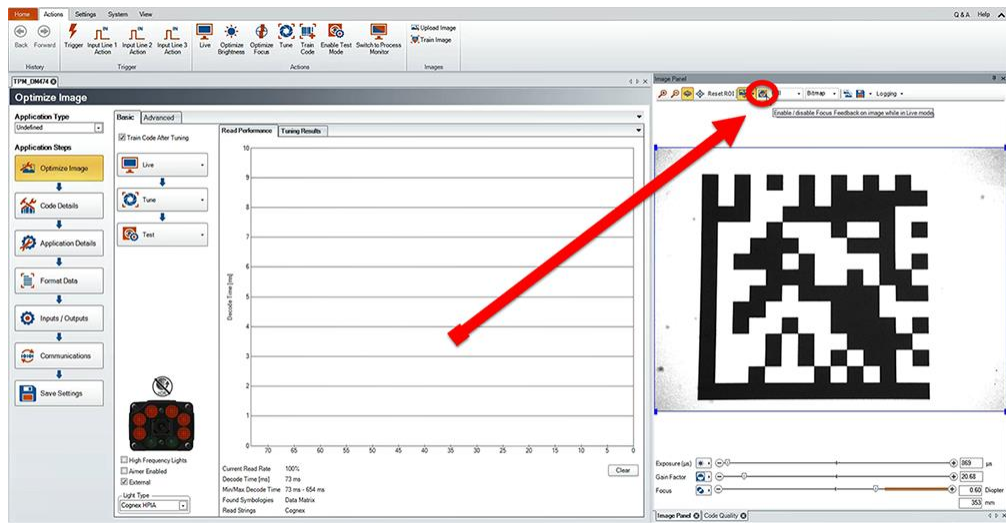

- Click the **Optimize Focus** button to optimize the focus of the liquid lens. You can find this button in the lower left section of the image panel, or you can also optimize focus during tuning by checking the box in the tune dropdown.

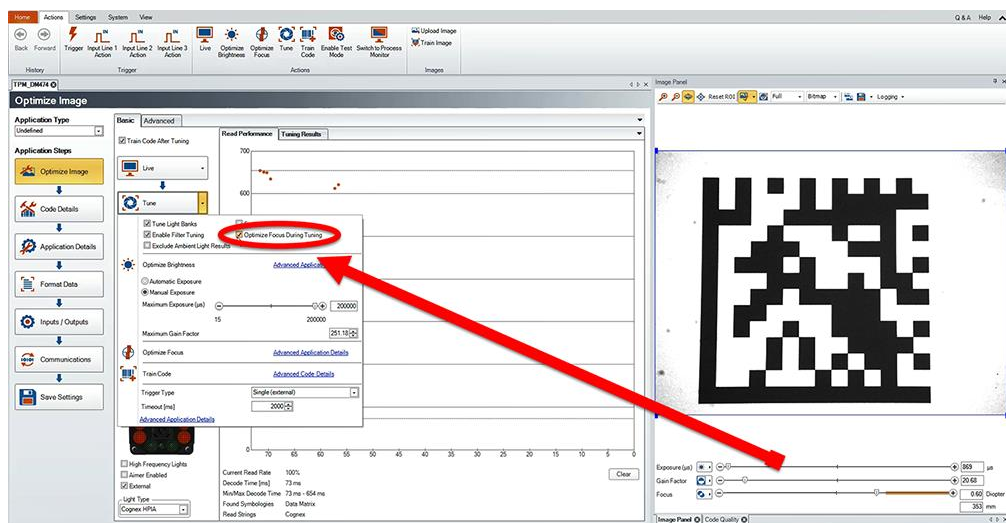
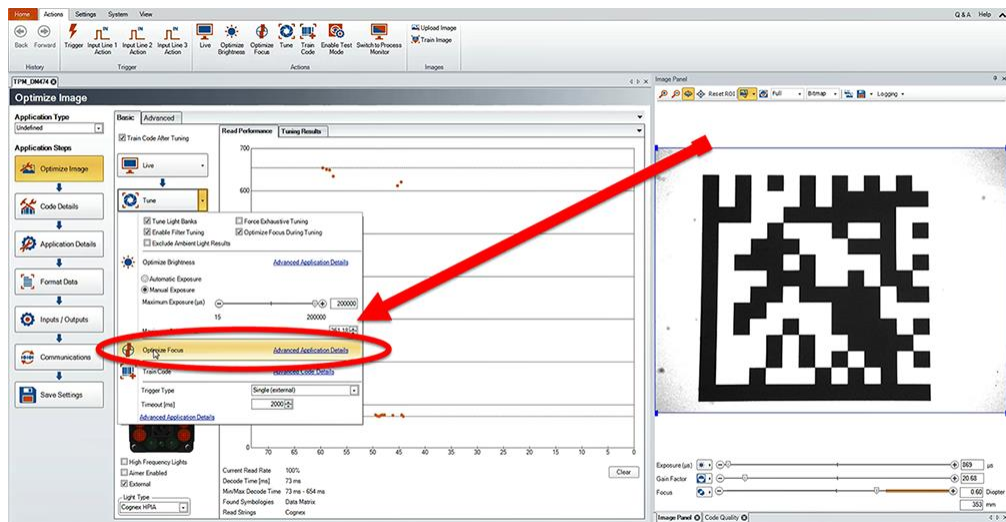
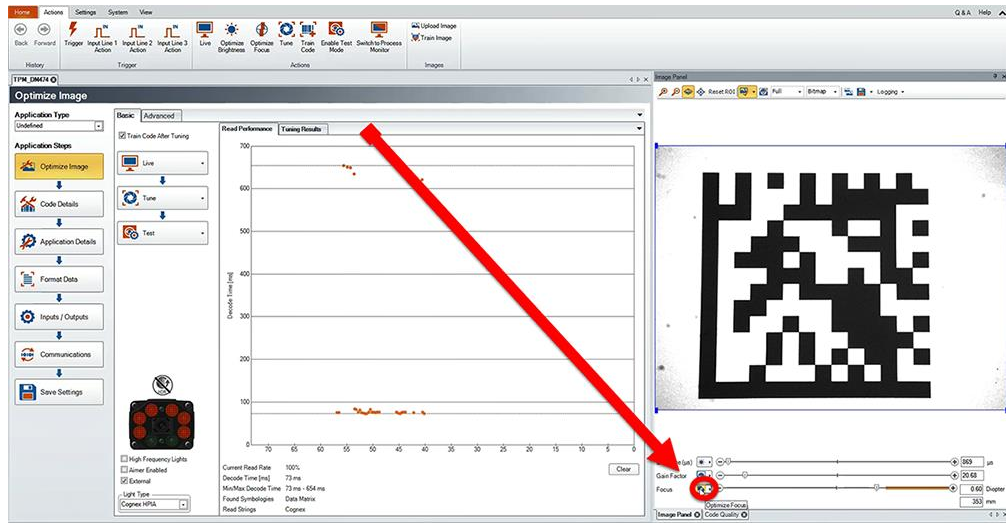

Manual Focus Lens

Click the **Focus Feedback** button in the image panel in SetupTool to enable focus feedback.

This enables a color-coded focus feedback bar on the right side of the image panel. Once focus feedback is enabled, enter live mode and manually adjust the lens until the focus feedback bar is green.

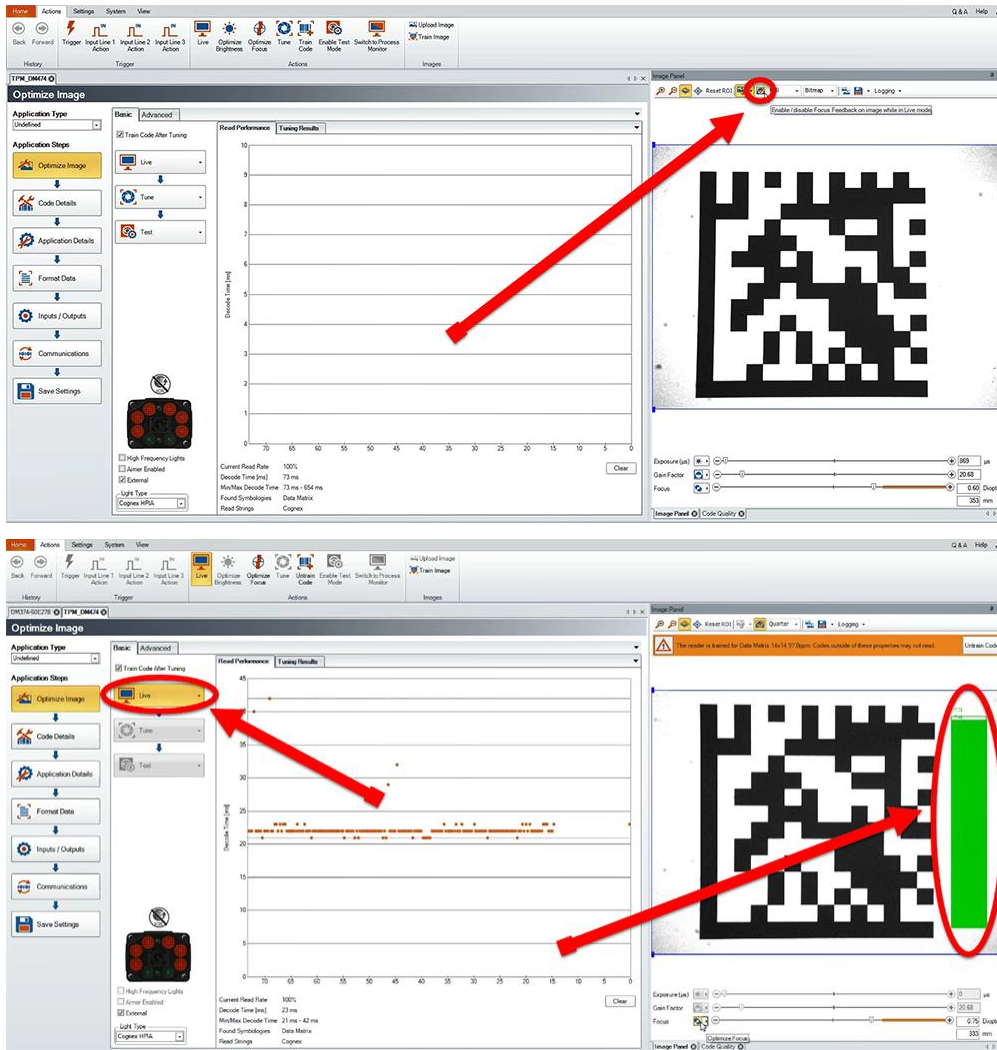

Focus Feedback

Focus is indicated by colors ranging from red (bad focus) to green (sharp focus). When focusing the reader, you need to adjust its position until the focus column becomes green.

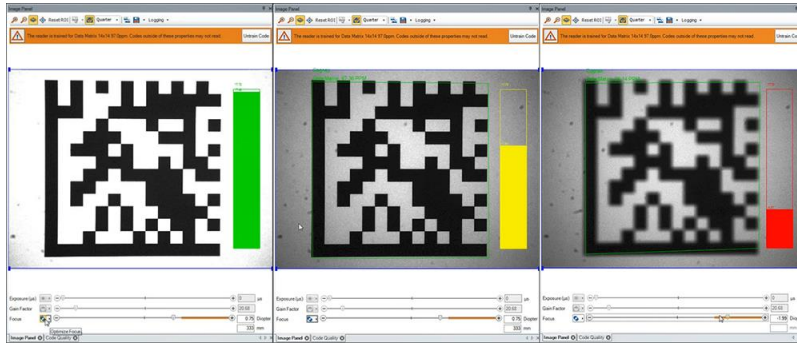

Best Practices

Both **Optimize Focus** and the **Focus Feedback** use the same procedure for testing the current focus. They consider various sub-regions of the image.

Follow these guidelines to maximize the performance of **Optimize Focus** and **Focus Feedback**:

- Use a focus target (such as the one supplied with this Reference Manual) that includes high-contrast features and is big enough that it fills at least a 100x100 pixel region in the center of the field of view at the desired working distance.
- Avoid floppy pieces of paper and make sure the target is perfectly flat.
- Make sure that the target is perfectly perpendicular to the optical axis of the reader.
- Make sure that the rest of the field of view, such as the part not covered by the focus target, does not contain any high-contrast features. For example, if you would ideally fill the entire field of view with a white card or sheet of paper (no shadows), position the focus target in the middle.
- The supplied 120x120mm focus target is appropriate for typical working distances. If you use such a working distance that the target does not completely fill the image, make sure that there are no high-contrast features visible outside of the target (see previous bullet).

Note:



- If you use the focus feedback indicator to adjust a manual focus lens, you must apply power to the reader before you remove the cover. If you remove the cover before applying power, the internal illumination will not function.
- If you use a Liquid Lens, make sure that the cover is mounted and connected before you apply power. If you attach or remove the front cover while the reader is powered, the focus setting is lost.

Field of View and Reading Distances

The following maps show the field of view of the DataMan 360 series readers. Reading distance values are also provided for 1-D and 2-D example code distances.

For the C-mount (or other non-Cognex) and S-Mount lenses, the focal length of the lens, focus setting, and aperture setting determine the field of view and reading distance.

Note: Due to tolerances, ranges can vary by +/- 5 % from unit to unit.

Reading Distance and Field of View (DataMan 360 Readers with a 10.3 mm Liquid Lens)

The map below shows the field of view (FoV) of the DataMan 360 readers with a 10.3 mm lens (with or without a liquid lens).

The FoV values are shown as follows:

- outer: DM362, DM363
- inner: DM360

The reading distances for the DM360 and DM362 readers are the same. DM363 features a higher resolution and more pixels in about the same sensor size.

The following table shows the FoV widths in mm at various distances.

Distances in mm	DM360	DM362/DM363
50	26	42
100	46	74
150	66	106
250	106	171
500	207	332

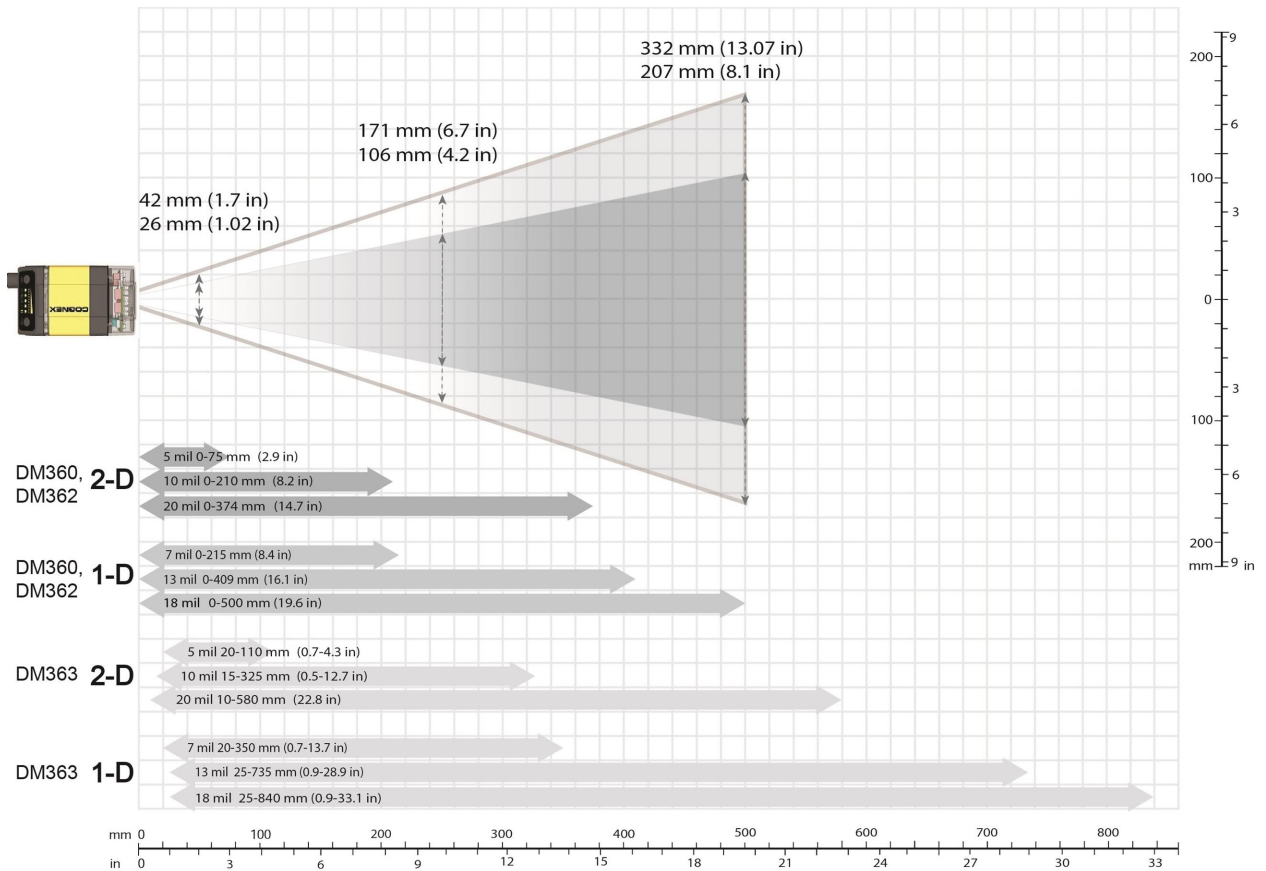

Reading Distance and Field of View (DataMan 360 Readers with a 16 mm Lens)

The following map shows the FoV of the DataMan 360 series readers with a 16 mm lens.

The FoV values are shown as follows:

- outer: DM362, DM363
- inner: DM360

The reading distances for the DM360 and DM362 readers are the same. DM363 features a higher resolution and more pixels in about the same sensor size.

The following table shows the FoV widths in mm at various distances.

Distances in mm	DM360	DM362/DM363
50	13	20
100	25	40
150	38	60
250	63	101
500	125	202

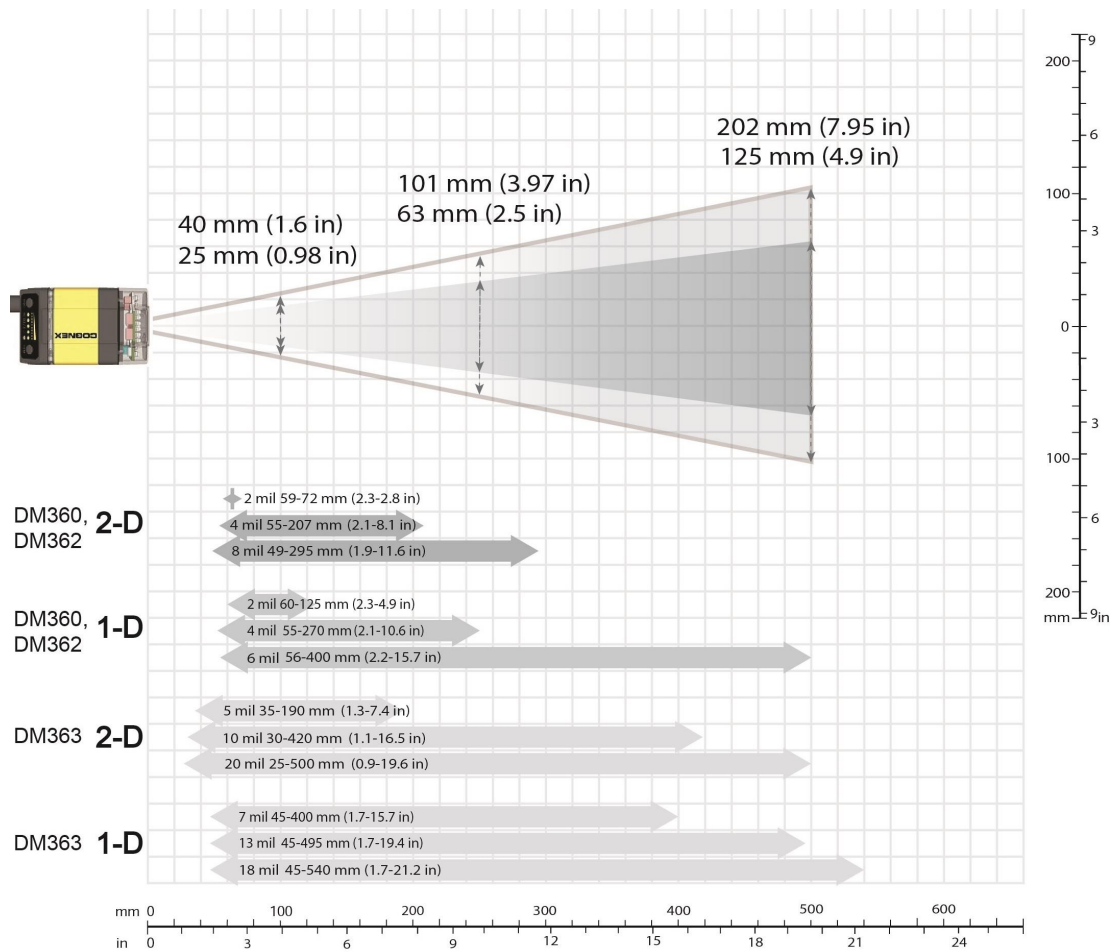

Reading Distance and Field of View (DataMan 360 Readers with a 19 mm Lens with a Liquid Lens)

The map below shows the FoV of the DataMan 360 series readers with a 19 mm lens with a liquid lens.

The FoV values are shown as follows:

- outer: DM362, DM363
- inner: DM360

The reading distances for the DM360 and DM362 readers are the same. DM363 features a higher resolution and more pixels in about the same sensor size.

The following table shows the FoV widths in mm at various distances.

Distances in mm	DM360	DM362/DM363
50	11	17
100	22	34
150	33	52
250	56	86
500	111	172

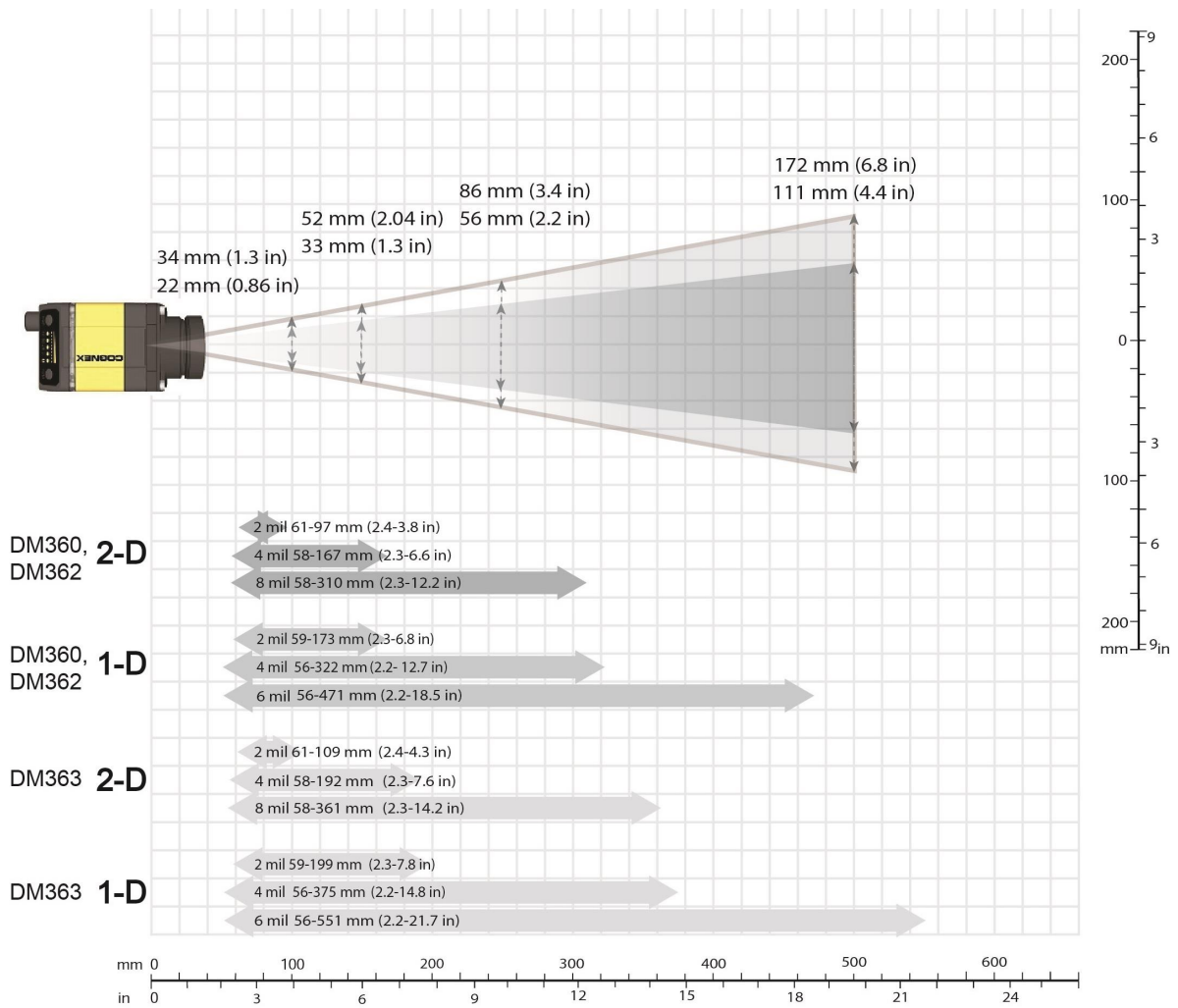

Reading Distance and Field of View (DataMan 360 Readers with a 24 mm Lens with Liquid Lens)

The following map shows the FoV of the DataMan 360 series readers with a 24 mm lens with a liquid lens and DM360-HPIL-RE-01 or DM360-HPIL-RE-P-01 cover.

The FoV values are shown as follows:

- outer: DM363
- middle: DM362
- inner: DM360

The reading distances for the DM360 and DM362 readers are the same. DM363 features a higher resolution and more pixels in about the same sensor size.

The following table shows the FoV widths in mm at various distances.

Distances in mm	DM360	DM362	DM363
80	11	19	20

Distances in mm	DM360	DM362	DM363
250	43	68	73
500	87	139	148
1000	175	281	298

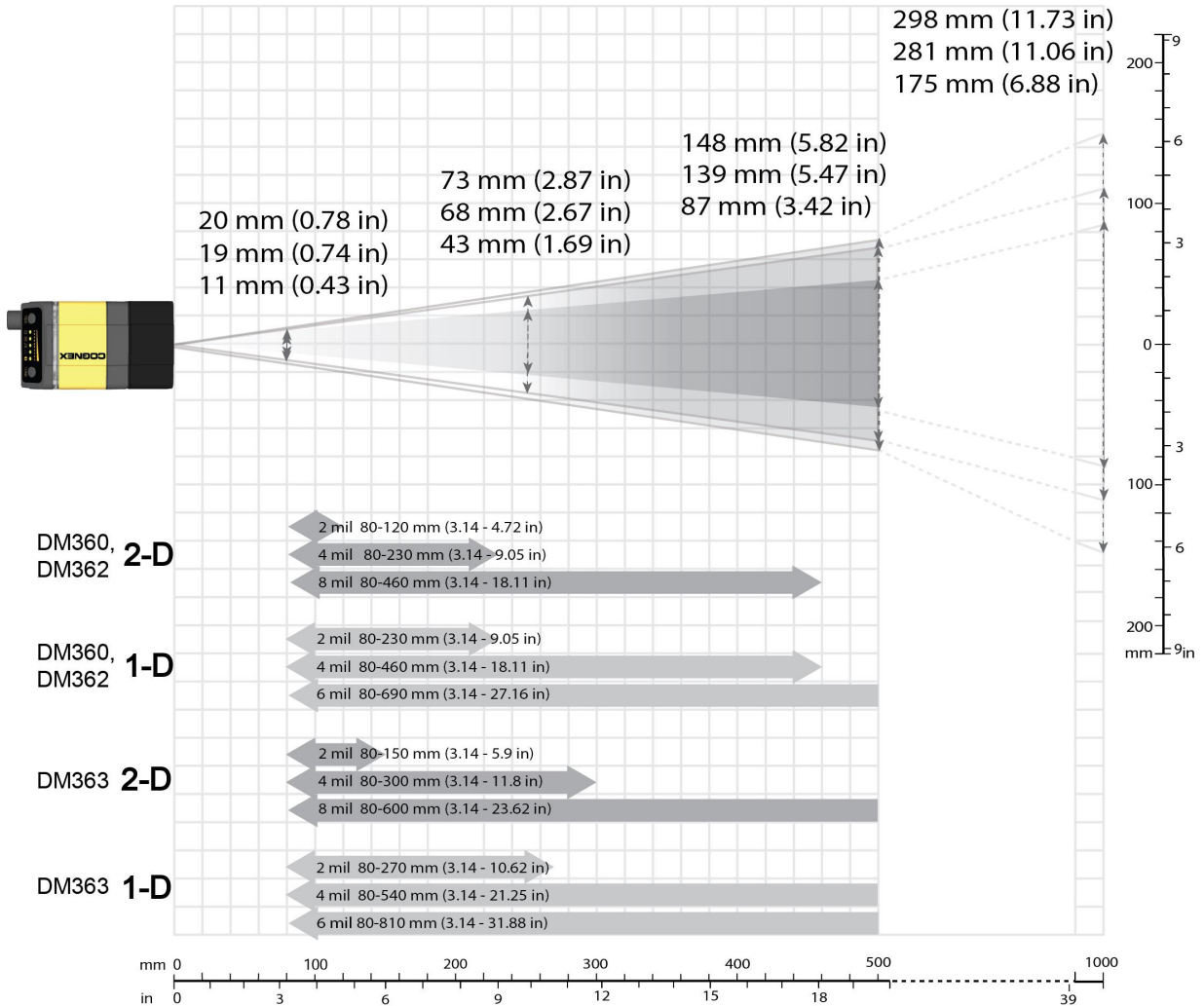

Reading Distance and Field of View (DataMan 360 Readers with a 25 mm Lens)

The following map shows the FoV of the DataMan 360 series readers with a 25 mm lens (with or without a liquid lens).

The FoV values are shown as follows:

- outer: DM362, DM363
- inner: DM360

The reading distances for the DM360 and DM362 readers are the same. DM363 features a higher resolution and more pixels in about the same sensor size.

The following table shows the FoV widths in mm at various distances.

Distances in mm	DM360	DM362/DM363
50	8	12
100	16	25
150	23	37
250	39	62
500	78	125

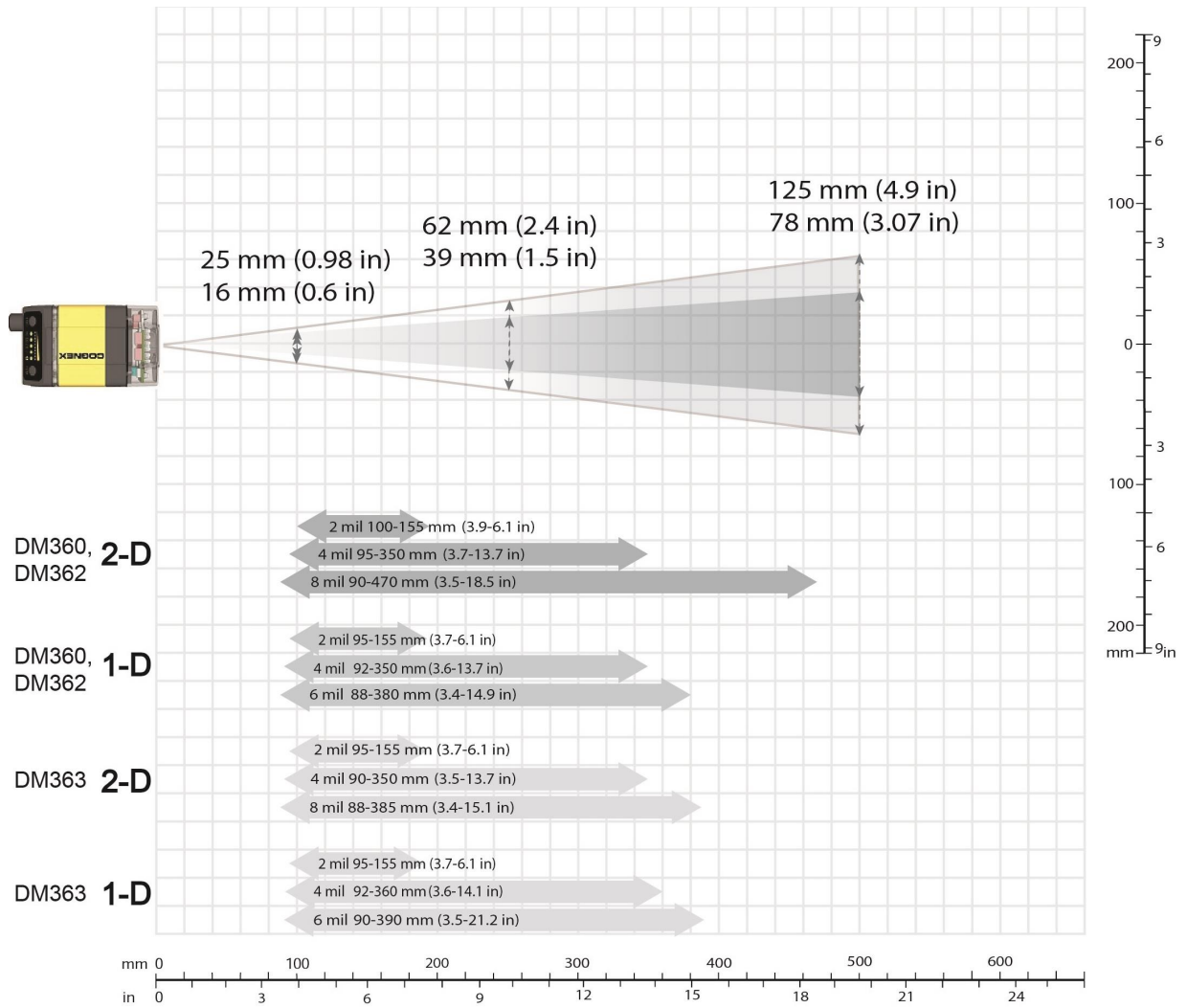

DataMan 360 Series Specifications

Specification	DataMan 360 Reader																								
Weight	165 g																								
Operating Temperature	0°C — 40°C (+32°F — 104°F)																								
Storage Temperature	-10°C — +60°C (+14°F — +140°F)																								
Maximum Humidity	< 95% (non-condensing)																								
Environmental	IP65 (with cable or protection cap attached to all connectors, front cover properly installed)																								
LED Safety	IEC62471: red illumination: Exempt Risk Group, blue and white illuminations: Risk Group 1 (Low-Risk). No further labeling is required.																								
RS-232	RxD, TxD according to TIA/EIA-232-F																								
Codes	<p>1-D barcodes: Codabar, Code 39, Code 128, and Code 93, Interleaved 2 of 5, MSI, Pharma, GS1 DataBar, Postal, UPC/EAN/JAN</p> <p>2-D codes: Data Matrix™ (IDMax and IDQuick: ECC 0, 50, 80, 100, 140, and 200), QR Code and microQR Code, MaxiCode, DotCode, Aztec Code, RSS/CS</p> <p>Stacked codes: PDF 417, MicroPDF 417</p>																								
Discrete I/O operating limits	<table> <tbody> <tr> <td>HS Output 0,1,2,3</td> <td>I_{MAX}</td> <td></td> <td>50 mA</td> </tr> <tr> <td></td> <td>R_{MIN}</td> <td>@ 12 VDC</td> <td>200 Ω</td> </tr> <tr> <td>Input 0 (Trigger)</td> <td>V_{IH}</td> <td>± 15 — ± 28 V</td> <td></td> </tr> <tr> <td>Input 1,2,3</td> <td>V_{IL}</td> <td>0 — ± 5 V</td> <td></td> </tr> <tr> <td></td> <td>I_{TYP}</td> <td>@ 12 VDC</td> <td>2.0 mA</td> </tr> <tr> <td></td> <td></td> <td>@ 24 VDC</td> <td>4.2 mA</td> </tr> </tbody> </table>	HS Output 0,1,2,3	I_{MAX}		50 mA		R_{MIN}	@ 12 VDC	200 Ω	Input 0 (Trigger)	V_{IH}	± 15 — ± 28 V		Input 1,2,3	V_{IL}	0 — ± 5 V			I_{TYP}	@ 12 VDC	2.0 mA			@ 24 VDC	4.2 mA
HS Output 0,1,2,3	I_{MAX}		50 mA																						
	R_{MIN}	@ 12 VDC	200 Ω																						
Input 0 (Trigger)	V_{IH}	± 15 — ± 28 V																							
Input 1,2,3	V_{IL}	0 — ± 5 V																							
	I_{TYP}	@ 12 VDC	2.0 mA																						
		@ 24 VDC	4.2 mA																						
Power Supply Requirements	<p>24 V +/- 10%</p> <p>Options:</p> <ul style="list-style-type: none"> Internal illumination (non-HPIL*): 250 mA maximum, 5 W Internal illumination (HPIL*): 2.2 A maximum, 6 W External illumination: up to 1.2 A average, 45 W, peak current according to illumination, these values depend on the illumination and its configuration <p>Supplied by LPS or NEC class 2 only</p> <p>*HPIL denotes one of the DM360-HPIL-RE or DM360-HPIL-RE-P accessories</p>																								
Light Connector	Current load up to 1.05 A average																								
Ethernet Speed	10/100																								
Duplex Mode	Full duplex or half duplex																								

DataMan 360 Series Imager Specifications

Specification	DataMan 360 Series Imager
Image Sensor	1/1.8 inch CMOS
Image Sensor Properties	6.9 mm x 5.5 mm (H x V); 5.3 μm square pixels (DataMan 360 and 362), 4.5 μm square pixels (DataMan 363)
Image Resolution (pixels)	<ul style="list-style-type: none"> DataMan 360: 800 x 600 DataMan 362: 1280 x 1024 DataMan 363: 1600 x 1200
Electronic Shutter Speed	<ul style="list-style-type: none"> minimum exposure: 5 μs (DataMan 360 and 362), 12 μs (DataMan 363) maximum exposure: 1000 μs with internal illumination/100000 μs with external illumination
Image Acquisition at Full Resolution	<ul style="list-style-type: none"> DataMan 360 and 362: up to 60 fps DataMan 363: up to 40 fps
Lens Type	<ul style="list-style-type: none"> S-Mount 10.3 mm F:5 (with optional liquid lens) with IR blocking filter S-Mount 16 mm F:9, no IR blocking filter C-Mount 24 mm F:6 (with liquid lens only) with IR blocking filter S-Mount 25 mm M12 lens, no IR blocking filter C-Mount lenses (with limitations, see below)

Limitations to C-Mount lenses:

- The length of the thread may not exceed 5.4 mm.
- For a chosen lens, the distance from the C-mount shoulder to the bottom of the lens may not exceed 5.4 mm. Possibly a lens spacer is required.
- When using the C-Mount lens cover, lens dimensions including spacer and filters may not exceed 32 x 42 mm (diameter x length).

To avoid accelerated aging of built-in illumination LEDs, which results in light intensity degradation, consider the following duty cycle limits above 25°C (77 °F):

- at 35 °C (95 °F): 4% duty cycle, for example, 750 μs exposure and 18493 μs interval
- at 45 °C (113 °F): 2% duty cycle, for example, 350 μs exposure and 18093 μs interval or 1000 μs exposure and 50000 μs interval







LED Wavelengths

The following table shows LED types and the related peak wavelengths:

LED	λ [nm]
WHITE	6500K (Color Temperature)
BLUE	470
RED	617

LED	λ [nm]
HIGH POWER RED	617
IR	850

Illumination Options

Illumination Board (in Lens Covers)	24V Externally Powered			
	Max. exposure time	Max. duty cycle	Max. LED-on time	Max. exposure time with LED-on
White LED (Clear) 	200 ms	6%	1 ms	3 ms
Red LED (Diffuse) 	200 ms	6%	1 ms	3 ms
Blue LED (Diffuse) 	200 ms	6%	1 ms	3 ms
IR LED (Diffuse) 	200 ms	6%	1 ms	3 ms
Red LED (Polarized) 	200 ms	6%	1 ms	3 ms
Red LED High Power Integrated Light (Unpolarized) 	200 ms	5%	25 ms	200 ms

Illumination Board (in Lens Covers)	24V Externally Powered			
	Max. exposure time	Max. duty cycle	Max. LED-on time	Max. exposure time with LED-on
Red LED High Power Integrated Light (Polarized) 	200 ms	5%	25 ms	200 ms

Using Your DataMan 360 Reader

This section provides information on the installation process of the DataMan Setup Tool, troubleshooting Ethernet connection issues, tuning, image filtering, as well as reader training and package detection.

Installing DataMan Software and Connecting the Reader

Follow the steps below to install and connect your reader to the DataMan Setup Tool:

1. Check the DataMan **Release Notes** for a full list of system requirements.
2. Download the DataMan Setup Tool from <http://www.cognex.com/support/dataman> and follow the on-screen steps.
3. Connect the DataMan 360 Series reader to your PC.
4. Launch the DataMan Setup Tool and click **Refresh**.
Detected readers will appear under **COM ports** or **Network devices**, or both.
5. Select a reader from the list and click **Connect**.

WARNING: Do not stare into beam when adding, removing, or changing cables. Cognex recommends to unpower the reader any time you make physical changes to it.

Follow the steps below to connect your reader to power and network:

CAUTION: Make sure that the reader is not receiving power before you perform any I/O wiring or adjustments to I/O devices.

CAUTION: Make sure that the Ethernet cable is grounded at the far end. Whatever this cable is plugged into (usually a switch or router) should have a grounded Ethernet connector. Use a digital voltmeter to validate the grounding. If the far end device is not grounded, add a ground wire in compliance with local electrical codes.

1. Connect the I/O+RS232+24V cable to your reader.
2. For a network connection, connect your reader, through an Ethernet cable, to your network.
3. Connect the cable to a 24V power supply.

Troubleshooting an Ethernet Connection

Based on your network configuration, the DataMan Setup Tool may not be able to communicate with the reader and it will not appear in the list of **Network devices**.

1. First, check your Ethernet connection with the reader and click **Refresh** in the DataMan Setup Tool.
2. Next, scan the **Enable DHCP** code in the **Reader Configuration Codes** document available from the **Start** menu.
This might allow the reader to acquire a suitable IP address from a DHCP server on your subnet.

If the reader still does not appear, you can use either the **Add Device** or **Force Network Settings** options in the DataMan Setup Tool.

For more information, see the **DataMan Setup Tool Reference Manual**.

You can also use the RS-232 connection to configure the reader with parameters that allow it to communicate over your Ethernet network.

Industrial Protocols

The DataMan 360 readers support the following industrial protocols:

- EtherNet/IP™
- PROFINET
- SLMP Protocol
- Modbus TCP

Select industrial protocol samples and tools you want to use when you install the DataMan Setup Tool.

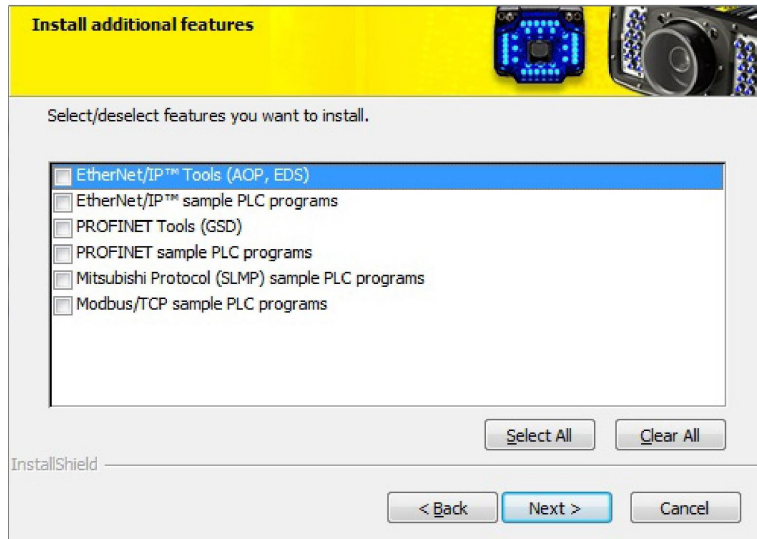

Use any of the following methods to enable or disable industrial protocols and then reboot the reader for the changes to take effect:

- Enable the protocols using the **Industrial Protocols** pane of the DataMan Setup Tool, under **Communications**.
- Scan the appropriate **Reader Configuration codes**. For more information, see *Reader Configuration Codes* available through the Windows **Start** menu or the DataMan Setup Tool **Help** menu.
- Send the appropriate **DMCC**. For more information, see *Command Reference* available through the Windows **Start** menu or the DataMan Setup Tool **Help** menu.

For more information on using the industrial protocols, see *DataMan Industrial Protocols Manual* available through the Windows **Start** menu or the DataMan Setup Tool **Help** menu.

DataMan 360 Series Triggering

DataMan 360 readers support the following trigger modes:

- **Self**: At an interval you configure, the reader automatically detects and decodes codes in its field of view. If you set a higher re-read delay than the trigger interval, there is a code output only once until the code is out of the field of view for the duration of the re-read delay.
- **Single** (external trigger): Acquires a single image and attempts to decode any symbol it contains, or more than one symbol in cases where multicode is enabled. The reader relies on an external trigger source.
- **Presentation**: Scans, decodes and reports a single code in the field of view. The reader relies on an internal timing mechanism to acquire images.

- **Manual:** Begins acquiring images when you press the trigger button on the reader, and continues acquiring images until a symbol is found and decoded or you release the button.
- **Burst:** Performs multiple image acquisitions based on an external trigger and decodes any symbol appearing in a single image or within a sequence of images, or multiple symbols in a single image or within a sequence of images when multicode is enabled. You can control the number of images within each burst and the interval between image acquisitions.
- **Continuous:** Begins acquiring images based on a single external trigger and continues to acquire and decode images until a symbol is found and decoded, or until multiple images containing as many codes as specified in multicode mode are located, or until the trigger is released. You can configure your reader to acquire images based on the start and stop signal from separate digital IO pulses.

In **Single**, **Burst**, **Continuous**, and **Self** trigger modes, it is possible to **synchronize image acquisition** on multiple devices using the synchronization interface. Synchronization allows using one shared strobe illumination to expose all sensors simultaneously. You can synchronize multiple readers with optionally triggering them in a defined sequence to avoid that opposing readers blind each other. Note that this and other imager settings will not get synchronized by this mechanism - for example, you must configure exposure and gain on each reader individually. This feature only synchronizes the actual image acquisition, triggering happens through the existing Multi-Reader Sync mechanism.

To set up synchronized acquisition on DataMan 360, enable PTP (Precision Time Protocol) on the **Multi-Reader Sync** pane of the DataMan Setup Tool under Synchronized Readers (IE1588). Set the Secondary Reader Only accordingly on each reader individually to define **Multi-Reader Sync** reader relations.

The setting in 7 steps:

1. Check the Enable PTP check box.
2. Keep set the Secondary Reader Only check box if there is already a PTP master clock in the net (uncheck otherwise on at least one reader)
3. Tune fine by Priority 1 and Priority 2
4. Enable Multi-Reader Sync by trigger: Use PTP to actually sync Multi-Reader Sync triggering
5. Time between Trigger Start and the Synchronized Acquisition Timestamp: Time the Primary Reader adds to the trigger to make sure all devices already received the trigger message before this time stamp.
6. Local Offset Added to the Synchronized Acquisition Timestamp: Time the Secondary Reader adds to the timestamp to realize offset image acquisitions.

Synchronized Readers (IEEE1588)

PTP Stack Parameters

Enable PTP

Slave Only

Priority 1 0 255

Priority 2 0 255

Status

Trigger Synchronization

Enable MST Synchronized by PTP

Time Between Trigger Start and the Synchronized Acquisition Timestamp [μ s] 0 1000000

Local Offset Added to the Synchronized Acquisition Timestamp [μ s] 0 1000000

External Triggers

If you are using external triggering, you can use any of the following methods to trigger your DataMan 360 reader:

- Press the trigger button on the reader.



- Send a pulse on the I/O cable:
 - Trigger + (orange or red)
 - Trigger - (black)
- Send a serial trigger command over the RS-232 connection connection.
- Press <CTRL-T> on the keyboard while the DataMan Setup Tool has the input focus.

- Click the **Trigger** button in the DataMan Setup Tool:

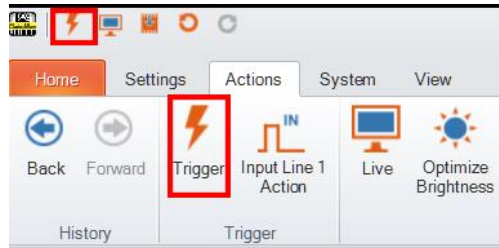

DataMan 360 Series Multi-Reader Sync Option

For trigger modes other than **Presentation**, the DataMan 360 supports multi-reader trigger synchronization, also known as Multi-Reader Sync. In this option, you configure multiple DataMan readers as a group. Whenever any reader in the group is triggered, all the readers are triggered and the results from all the readers are assembled and transmitted by a single reader that you designate as the Primary Reader.

Multi-Reader Sync is used to support extended field of view reading and reading codes from multiple product surfaces:

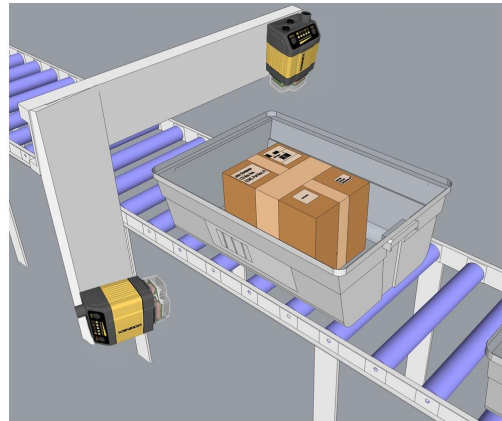
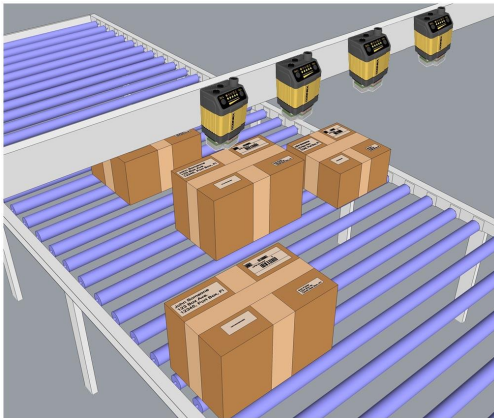

To configure Multi-Reader Sync, go to the group editor in the DataMan Setup Tool. For more information, see the *Setup Tool Reference Manual*.

In **Single**, **Burst**, **Continuous**, and **Self** trigger modes, it is possible to **synchronize image acquisition** on multiple devices using the synchronization interface. Synchronization allows using one shared strobe illumination to expose all sensors simultaneously. You can synchronize multiple readers, with optionally triggering them in a defined sequence to avoid that opposing readers blind each other. Note that this and other imager settings will not get synchronized by this mechanism - for example, you must configure exposure and gain on each reader individually. This feature only synchronizes the actual image acquisition. Triggering happens through the existing Multi-Reader Sync mechanism.

To set up synchronized acquisition on DataMan 360, enable PTP (Precision Time Protocol) on the Multi-Reader Sync pane of the DataMan Setup Tool under Synchronized Readers (IE1588).

Perform the following steps:

1. Check **Enable PTP**.
2. Keep **Secondary Camera Only** checked if there is already a PTP Primary Reader clock in the network (uncheck the checkbox otherwise on at least one reader).
3. Enable **MRS Synchronized by PTP** to synchronize Multi-Reader Sync triggering.

4. Set the **Time between Trigger Start and the Synchronized Acquisition Timestamp**. This is the time the Primary Reader adds to the trigger to make sure all devices already received the trigger message before this time stamp (Primary Reader Only).
5. Set the **Local Offset Added to the Synchronized Acquisition Timestamp**. This is the time the Secondary Reader adds to the timestamp to realize offset image acquisitions (Secondary Reader Only).

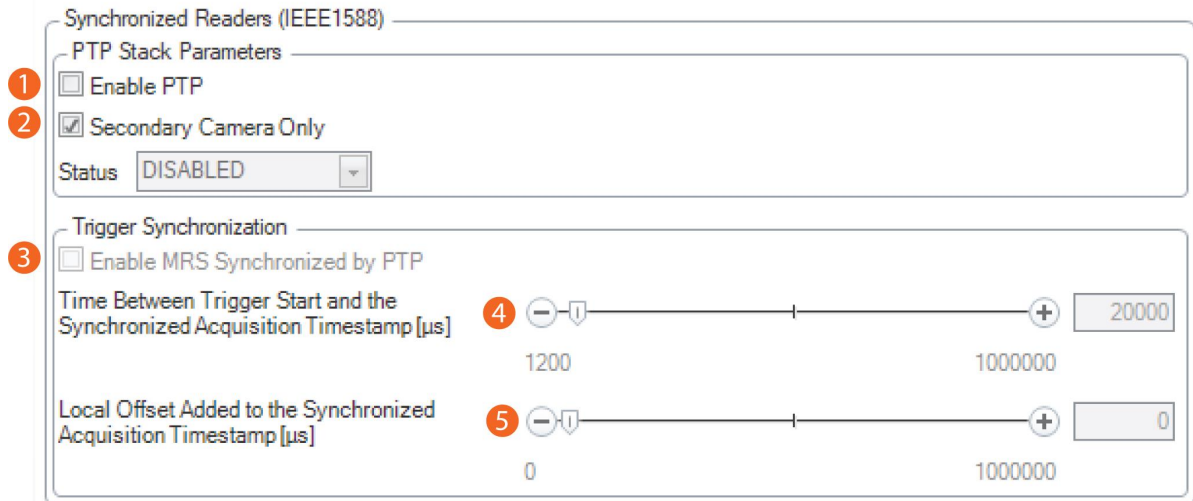

Note: The DataMan 360 readers use IEEE1588 for high-speed trigger synchronization.

DataMan 360 Series Tuning

By tuning, your reader automatically selects the best settings for the given reading situation, based on parameters of illumination, camera and decoder properties, and focal distance. Tuning autodiscriminates all enabled symbologies (both 1-D and 2-D). If multiple symbols are found in the field of view, tuning locks on the first one found. Use this feature to create an optimum setting to read your codes.

You can use any of the following methods to tune your reader:

- Press the **Tune** button at least for 3 seconds on your reader. The first press starts the tuning, and the second press cancels the tuning, if it is still ongoing.



- Turn on tuning in the DataMan Setup Tool.

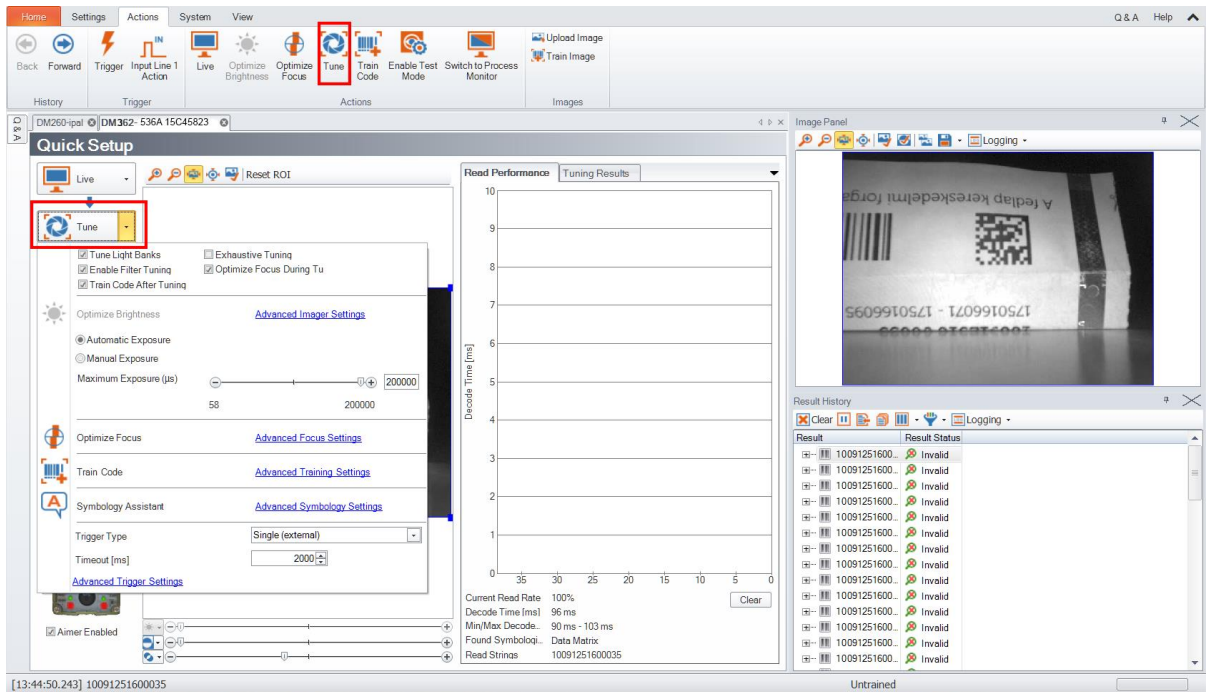

- Start tuning by sending a DMCC, for more information, see the **DataMan Control Commands Documentation**, available through the Windows **Start** menu or the DataMan Setup Tool **Help** menu.
- Use Input line 1 for tuning. Go to the **System Settings** pane of the DataMan Setup Tool and check **Tune**.

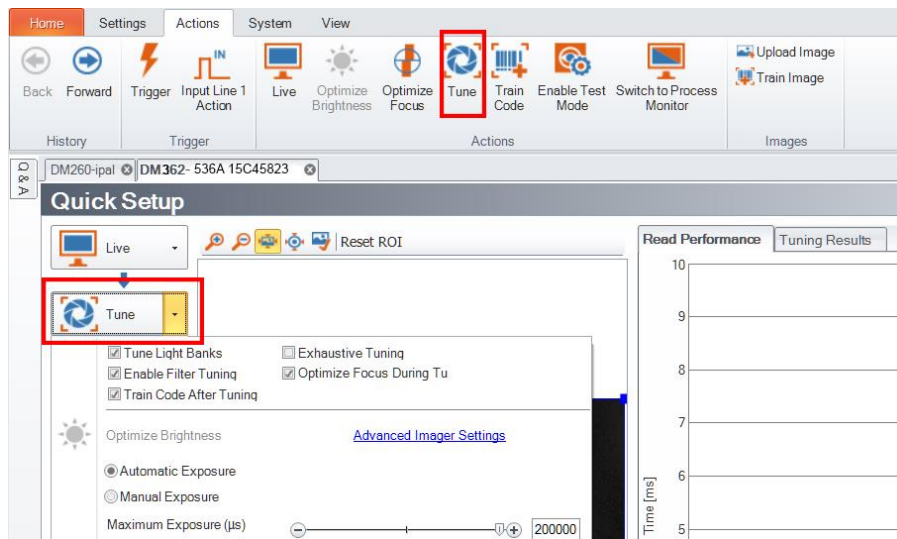

You can also use the **Input Line 1 Action** button on the toolbar.



Note: Tune button can toggle the aimer light ON and OFF.

DataMan 360 Series Image Filtering

You can define a stack of filters to be applied to each image acquired by your DataMan 360 series reader. To select the following filters in DataMan Setup Tool, click the **Optimize Image** pane, select the **Advanced** tab, click the triangle next to **Image filtering**, click "..." next to No Filtering for more options, then click the **Add** button.

- *Equalize*
This filter redistributes the brightness values of the pixels in the image. As a result, the range of brightness levels are more evenly represented. Use this filter if you have too dark or too bright images.
- *Stretch*
This filter linearly scales up or stretches the greyscale values in the input image to the full 256-step greyscale. The result is an output image with increased contrast.
- *Low Pass*
Using this filter results in output images where edges are smoothed or blurred.
- *Dilate*
This filter increases bright features and shrinks dark features. The result is an output image with larger areas of bright pixels. Use this filter to remove dark specks.
- *Erode*
This filter shrinks bright features and increases dark features. The result is an output image with larger areas of dark pixels. Use this filter to remove light specks.
- *Open*
This filter performs an erosion followed by a dilation to filter out bright features that are smaller than the size of the processing neighborhood. The result is an output image with slightly decreased overall brightness.
- *Close*
This filter performs a dilation followed by an erosion to filter out dark features that are smaller than the size of the processing neighborhood. The result is an output image with slightly increased overall brightness.
- *Auto Stretch*
This filter reduces the pixel value range. It maps the pixel values from 0 to 255.
- *Optical Density*
This filter specifies an inversion of pixel values based on a logarithmic scale. The result is an output image that reveals the density of objects and features in the input image by measuring the amount of light that passes through them. Denser objects and features are represented by lighter pixels in the output image.
- *Invert*
This filter specifies an inversion of pixel values based on the 256-step greyscale. The result is an output image that is a "negative" of the input image.

To use Image Filtering, perform the following steps:

1. On the Image Filtering pane, click **Add**.
2. Select a filter from the **Filter Properties** drop-down box. You can add more than one filter. You can also specify the order in which filtering is done by moving the filters using the **Up** and **Down** buttons.
3. If the filter you selected require further settings, change properties according to your needs.
4. Change the selection in the **Image to Use** group box according to the symbology you want to be filtered (after making sure that that Symbology is enabled):

If no image is read, the Results Display shows the image according to your selection under No-Read Image.

5. Go to the Displayed Image Settings pane and change the Images to Use according to what you want to see on Live Display: the original or the filtered image.
6. You can compare the original and filtered results on the Results Display if you choose the images from the Read Result History.
The example images were taken using the Equalize filter.

Training the Reader

Training your reader with the expected symbology can make the time required to decode successive symbols more consistent. In addition, training may help increase decode yield.

To train your reader, place a code in front of the reader and do one of the following:

- Press and hold the trigger button for a minimum of 3 seconds.



- Click and hold the trigger button in the DataMan Setup Tool for a minimum of 3 seconds.



- Click **Train Code** under **Actions** on the ribbon bar.

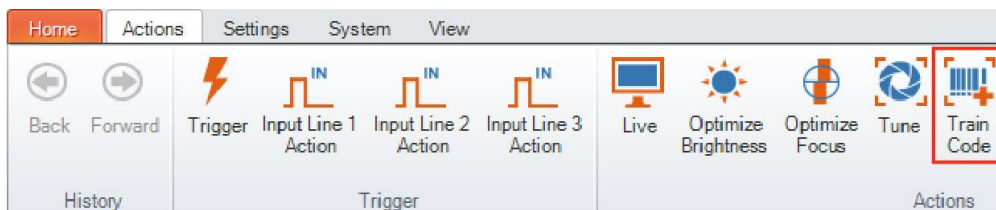

You can use training in **Single**, **Burst**, **Continuous** or **Self** trigger modes.

Note: Only a single symbol of each symbology kind can be trained.

Training Feedback

The second LED from left on the reader glows green to indicate that it is currently trained, or yellow to indicate that it is not trained.



Connect the reader to the DataMan Setup Tool to untrain it and allow it to recognize other enabled symbologies.

Incremental Training for Multiple Symbologies

If you want to train the reader to recognize multiple symbologies, you can present a single image showing all the desired symbologies and perform the training procedure previously described.

If you cannot present a single image showing all the necessary symbologies, you can enable incremental training under **Training** on the **Advanced** tab of the **Code Details** pane:

The screenshot shows the 'Code Details' pane with the 'Advanced' tab selected. The 'Training' section is expanded, and the 'Incremental Training' checkbox is checked and highlighted with a red box. Other settings visible include 'Number of Codes' set to 1, 'Allow Partial Results' unchecked, and 'Sorting Priority' set to 'Symbology'.

With incremental training enabled, you can train the reader using multiple images showing the symbologies you expect to decode. The reader will train each new symbology while retaining the existing trained symbologies.

Package Detection Support

You can connect your package detection sensor to one of the digital inputs of your DataMan reader. When the reader receives a signal that a package is detected, images that the reader collected are not discarded at the end of the trigger. This way you can make sure that there was a package there, only the code was not readable. Looking at the No Read images will help you find out why there were no decode results.

Package detection is only supported with Continuous trigger mode.

To make sure that the No Read images are collected, perform the following:

1. Connect your package detection device to one of the Inputs of your reader.
2. On the **Inputs/Outputs** pane, check **Allow Buffered No-Read Images** on the input you connected your reader to.
3. On the **Inputs/Outputs** pane, click **Buffering and Transfer**, and in the **Image Buffering** pane, change **What Results to Buffer** under Buffering Settings to All, or No Read.
 - In the case of **All**, good reads are also saved together with No Reads.
 - In the case of **No Read**, the image is buffered if the reader fails to read.

For more information, see the *DataMan Fixed-Mount Readers Reference*, available through the Windows **Start** menu or the DataMan Setup Tool **Help** menu.

Connections, Optics, and Lighting

This section contains descriptions about the external light control, I/O Cables, high-speed outputs, high-speed output wiring, Ethernet M12 to RJ45 cable, and acquisition trigger.

External Light Control (CCB-M12XFLY-05)

A 4-pin cable is provided for the external light control. The External Light cable is used to connect to an external lighting device, providing power and strobe control.

The drawing on the left shows the socket on the device.

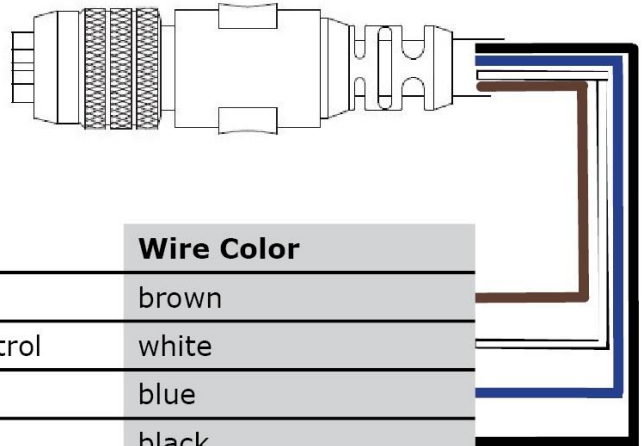
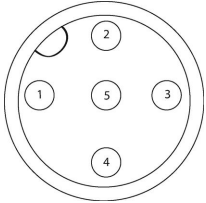

Pin #	Signal Name	Wire Color
1	+24 VDC	brown
2	Brightness Control	white
3	GND	blue
4	Strobe	black
5	Chassis	not connected

Output Voltage	24 V+/-5% (20 V – 27 V) Voltage may drop depending on the length of the cable.	
	Max avg Current	1 A
	Peak Operating Current	1.5 A up to 100 μ s, avg to not exceed 1 A
	Max Inrush Current	5 A not exceeding 0.4 As

5 m Breakout Cable (CCBL-05-01)

The Breakout cable provides access to trigger and high-speed outputs. You can clip unused wires short or use a tie made of non-conductive material to tie them back. For RS-232, use the Power Supply return path for ground.

The figure on the left shows the plug on the device.

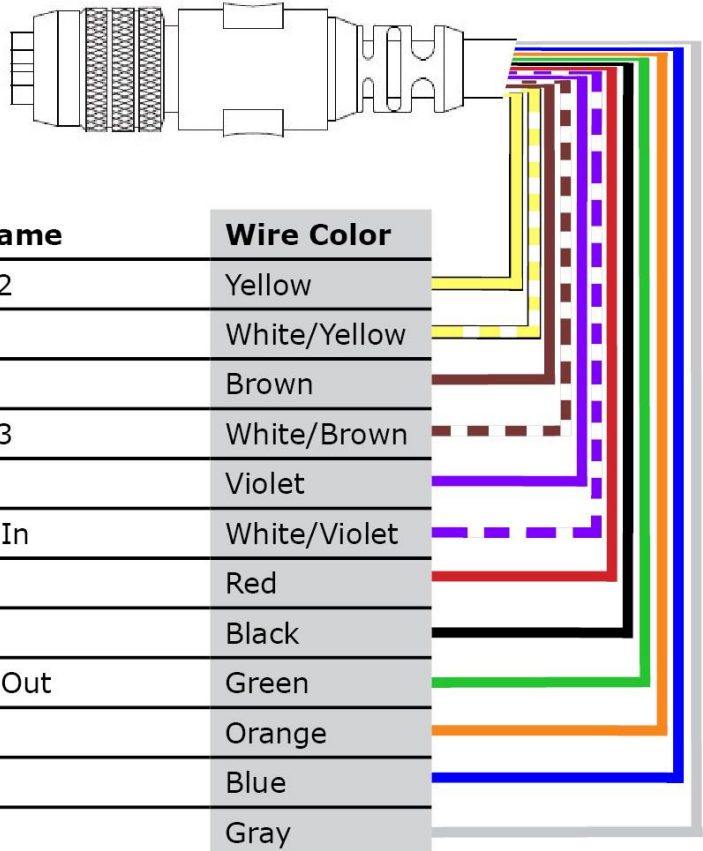

Pin #	Signal Name	Wire Color
1	Out 2/In 2	Yellow
2	TxD	White/Yellow
3	RxD	Brown
4	Out 3/In 3	White/Brown
5	In 1	Violet
6	Common In	White/Violet
7	+24 VDC	Red
8	GND	Black
9	Common Out	Green
10	In 0	Orange
11	Out 0	Blue
12	Out 1	Gray

5m Breakout Cable (CCB-M12x12Fy-xx)

The Breakout cable provides access to trigger and high-speed outputs. You can clip unused wires short or use a tie made of non-conductive material to tie them back.

The figure on the left shows the plug on the device.

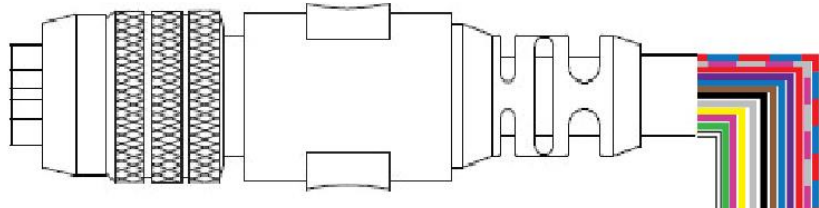

Pin #	Signal Name	Wire Color
1	Out 2/In 2	White
2	TxD	Green
3	RxD	Pink
4	Out 3/In 3	Yellow
5	In 1	Grey
6	Common In	Black
7	+24 VDC	Brown
8	GND	Blue
9	Common Out	Purple
10	In 0	Red
11	Out 0	Grey/Pink
12	Out 1	Red/Blue

15m Breakout Cable (CCB-PWRIO-15)

The Breakout cable provides access to trigger and high-speed outputs. You can clip unused wires short or use a tie made of non-conductive material to tie them back. For RS-232, use the Power Supply return path for ground.

The figure on the left shows the plug on the device.

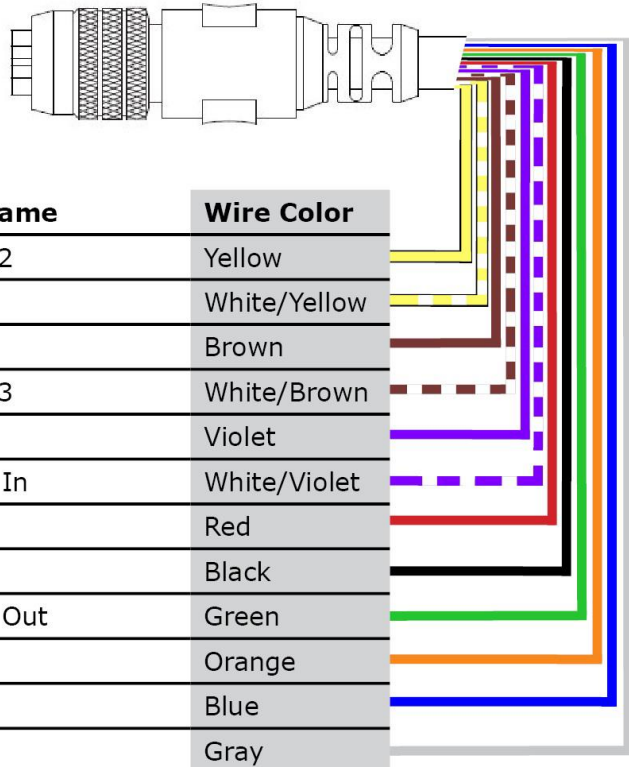

High-Speed Outputs

Specification	Description
Voltage	26.4 V maximum through external load
Current	50 mA maximum sink current
	OFF state leakage current 100 μ A
	External load resistance 240 Ohms to 10K Ohms
	Each line rated at a maximum 50 mA, protected against over-current, short circuits and transients from switching inductive loads. High-current inductive loads require external protection diode.

The high-speed outputs can be used as either NPN (pull-down) or PNP (pull-up) lines. For NPN lines, the external load should be connected between the output and the positive supply voltage (<26.4V). The outputs pull down to less than 3V when ON, which causes current to flow through the load. When the outputs are OFF, no current flows through the load.

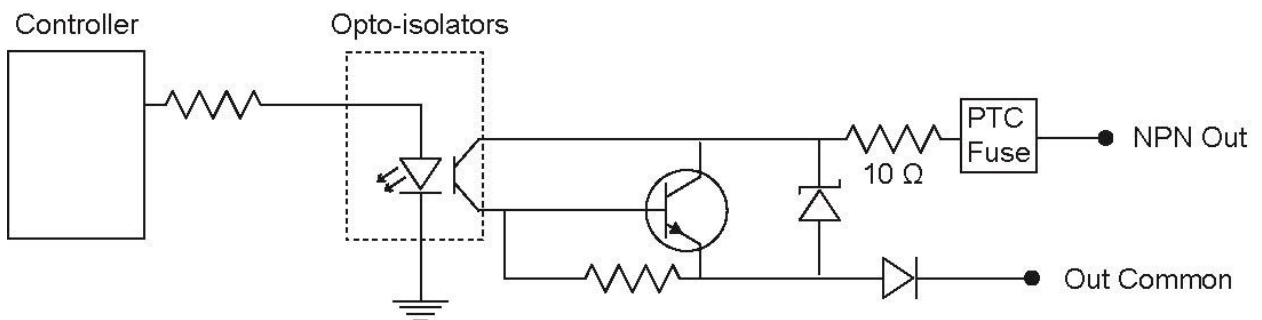

For PNP lines, the external load should be connected between the output and the negative supply voltage (0V). When connected to a 24VDC power supply, the outputs pull up greater than 21V when ON, and current flows through the load. When the outputs are OFF, no current flows through the load.

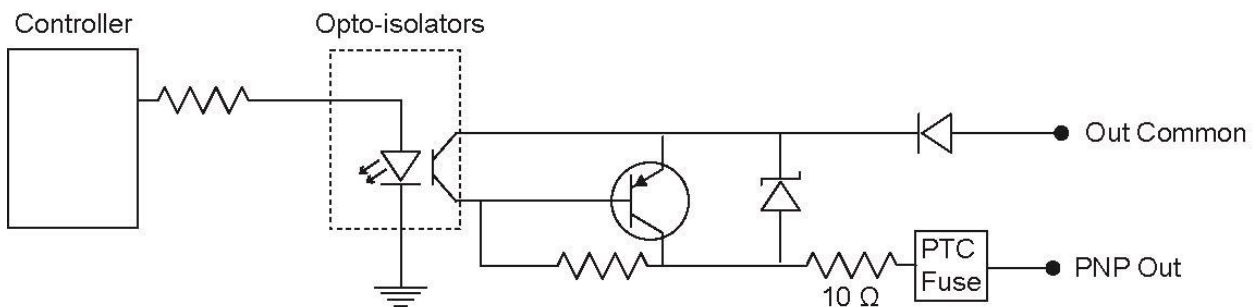

High-Speed Output Wiring

To connect to an NPN-compatible PLC input, connect High-Speed Output 0, Output 1, Output 2, or Output 3 directly to the PLC input. When enabled, the output pulls the PLC input down to less than 3V.

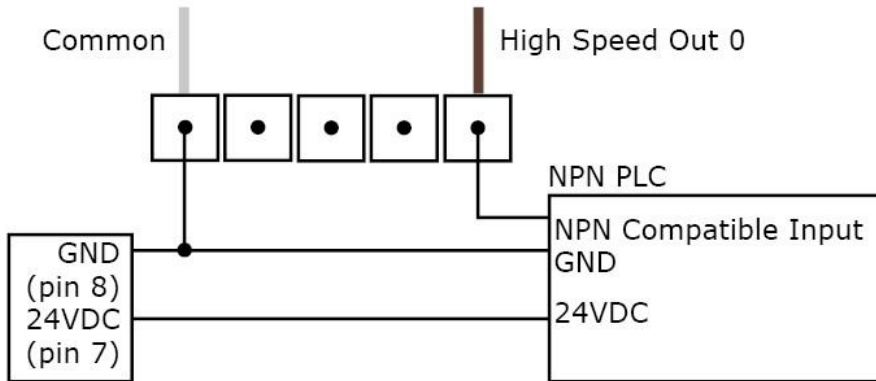

To connect to a PNP-compatible PLC input, connect High-Speed Output 0, Output 1, Output 2 or Output 3 directly to the PLC input. When enabled, the output pulls the PLC input up to greater than 21V.

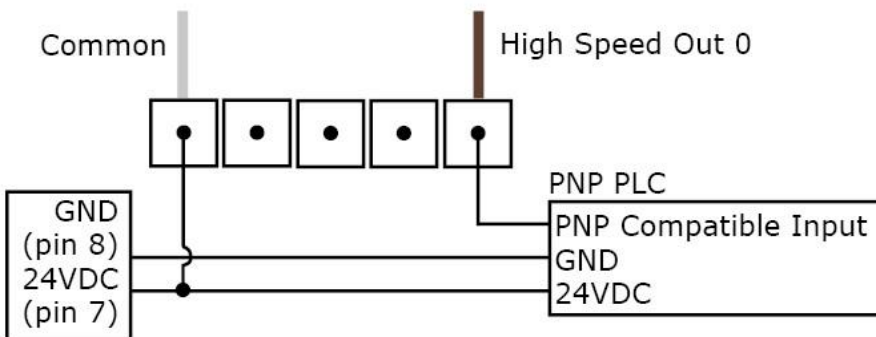

To connect the high-speed outputs to a relay, LED or similar load, connect the negative side of the load to the output and the positive side to +24V. When the output switches on, the negative side of the load is pulled down to less than 3V, and 24V appears across the load. Use a protection diode for a large inductive load, with the anode connected to the output and the cathode connected to +24V.

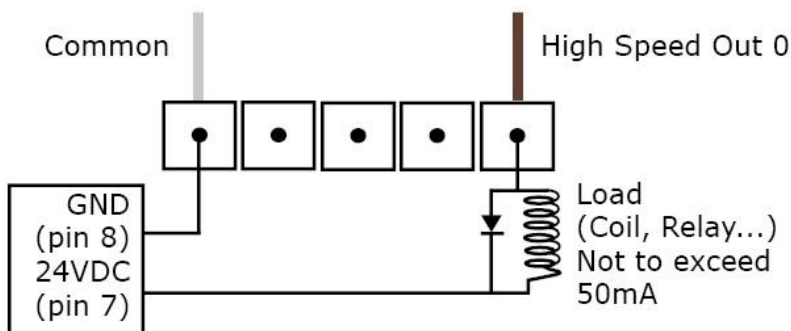

5m RS-232 Connection Cable (CCB-M12XDB9Y-05)

You can clip unused wires short or use a tie made of non-conductive material to tie them back.

The figure on the left shows the plug on the device.

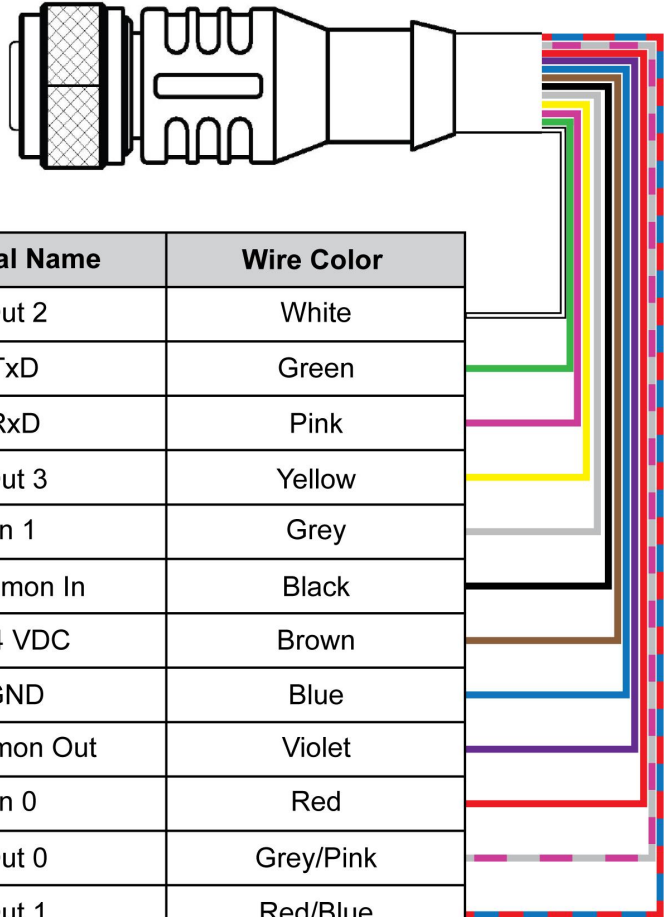
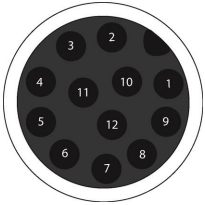

Pin #	Signal Name	Wire Color
1	Out 2	White
2	TxD	Green
3	RxD	Pink
4	Out 3	Yellow
5	In 1	Grey
6	Common In	Black
7	+24 VDC	Brown
8	GND	Blue
9	Common Out	Violet
10	In 0	Red
11	Out 0	Grey/Pink
12	Out 1	Red/Blue

Ethernet M12 to RJ45 Cable (CCB-84901-y00x-xx)

The Ethernet cable provides Ethernet connection for network communications. The Ethernet cable can be connected to a single device or provide connections to multiple devices via a network switch or router.

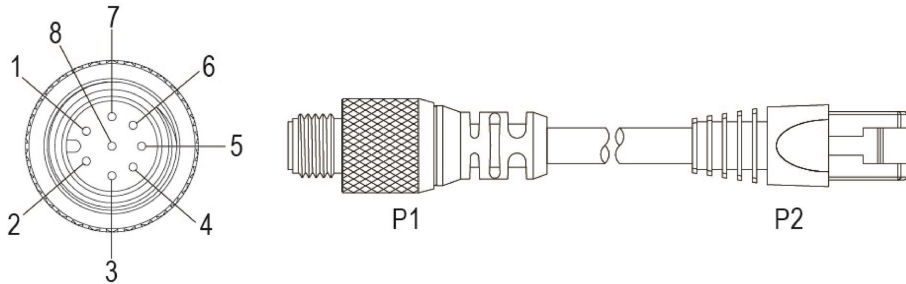

P1 Pin#	Signal Name	Wire Color	P2 Pin#
6	TPO+	White/Orange	1
4	TPO-	Orange	2
5	TPI+	White/Green	3
7	TRMA	Blue	4
1	TRMB	White/Blue	5
8	TPI-	Green	6
2	TRMC	White/Brown	7
3	TRMD	Brown	8

Note: Cables are sold separately. The wiring for this cable follows standard industrial Ethernet M12 specifications. This differs from the 568B standard.

Acquisition Trigger

The acquisition trigger input on the reader is opto-isolated. To trigger from an NPN (pull-down) type photoelectric sensor or PLC output, connect **Common In** to +24V and connect **In 0** to the output of the photoelectric sensor. When the output turns on, it pulls **In 0** down to 0V, turning the opto-coupler on.

To trigger from a PNP (pull-up) photoelectric sensor or PLC output, connect **In 0** to the output of the photoelectric sensor and connect **Common In** to 0V. When the output turns on, it pulls **In 0** up to +24V, turning the opto-coupler ON.

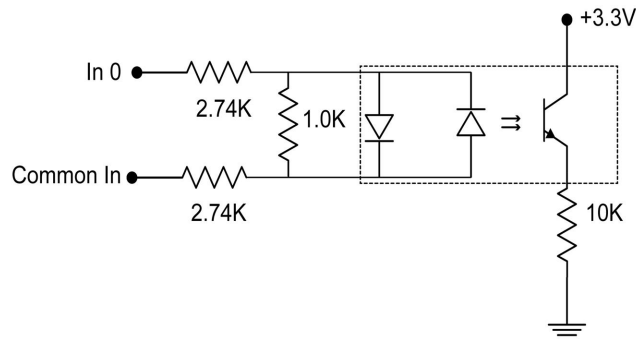

26.4V Max. across input pins - Transition approximately 12V (Min.)

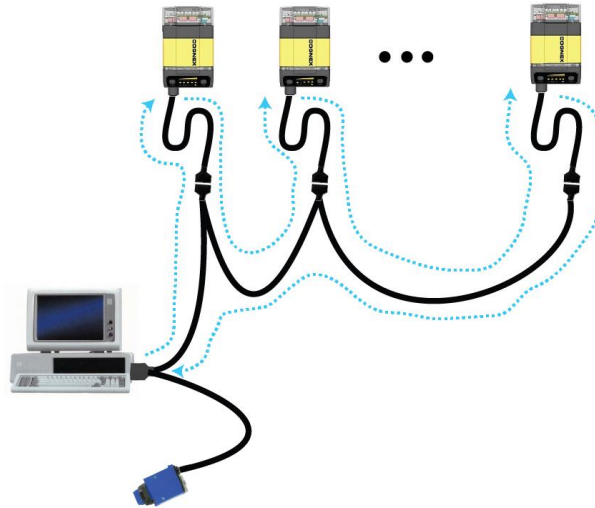

You must construct your own cable that meets the requirements of your system configuration.

The cable must provide a DB-15 connector for each DataMan 360 and a DB-9 connector for the PC serial port. Each DB-15 connector must provide Tx Data, Rx Data, Trigger (Input 0), ground, and DC power. The Tx Data and Rx Data pins on adjacent connectors must be connected to provide the multi-port connection.

The following diagram shows how to create a multi-port cable for a 3-reader system. In the example, all the readers share a common trigger. It is also possible to wire individual triggers for each reader.

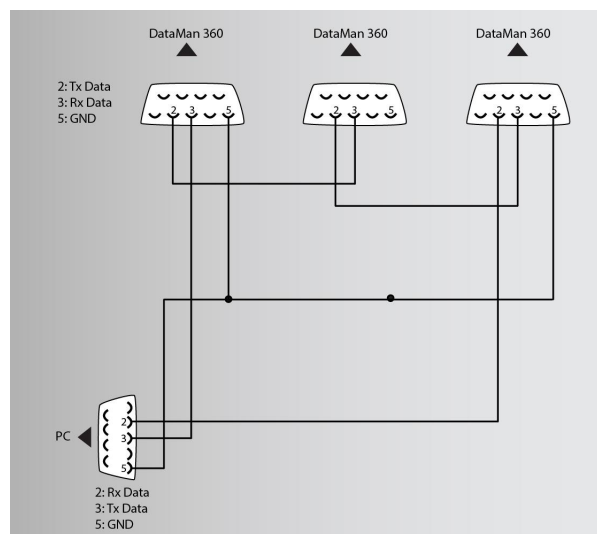

You must connect each DataMan 360 to the DataMan Setup Tool using a USB connection and set the DataMan for multi-port operation. To configure a DataMan 360 for multi-port operation, click the **Enable Multi-Port (RS-232 Sharing)** checkbox in the **Communications** application step's **Advanced** tab.

There is no guaranteed delivery order when multiple readers transmit data using a multi-port connection; read results can arrive at the PC in any order. You can configure each DataMan 360 reader in a multi-port connection to add identifying data to each read result. Your PC application can then determine which reader produced a specific read result.

1. In the **Format Data** application step, enable the **Basic Formatting** radio button.
2. Check **Standard** for each symbology that you are using.
3. Switch to the **Standard** tab and enter text in the **Leading Text** field.
4. You can also add trailing text by entering text in the **Terminating Text** field.

Keep the following guidelines in mind as you design your system:

- Make sure that the maximum cable length between any two DataMan 360 readers or between the PC and any DataMan reader is no greater than 15 meters.
- There is no fixed limit to the number of DataMan 360 readers that you can connect to a single PC. Each reader introduces a delay of about 100 ms when it retransmits received serial data. If you have 5 readers, this means that there will be a 400 ms delay between the time the first reader in the chain transmits data and the PC receives it.
- Each DataMan 360 reader must receive a hardware trigger signal on its Input 0 line. You can wire the input ports to a common trigger signal or you can provide individual triggers for each reader.
- Each DataMan 360 reader must be individually configured for multi-port operation, and you must perform this configuration using a USB connection.
- If *any* reader in the multi-port chain loses power or becomes disconnected, then no data from any other reader will be transmitted.
- If a DataMan 360 is transmitting its own read result, it will buffer any data received from another reader until it has finished its own data transmission. If a DataMan 360 is transmitting another reader's data, it will buffer its own data if it receives a trigger signal while it is processing the other reader's data.
- If you use a single power supply for multiple readers, make sure that the power supply can provide enough power for all of the readers.

Cleaning and Maintenance

Cleaning the Reader Housing

To clean the outside of the reader housing, use a small amount of mild detergent cleaner or isopropyl alcohol on a cleaning cloth. Do not pour the cleaner directly onto the reader housing.



CAUTION: Do not attempt to clean any DataMan product with harsh or corrosive solvents, including lye, methyl ethyl ketone (MEK) or gasoline.

Cleaning the Reader Lens Cover

To remove dust from the lens cover, use a pressurized air duster. The air must be free of oil, moisture or other contaminants that could remain on the lens cover. To clean the plastic window of the lens cover, use a small amount of isopropyl alcohol on a cleaning cloth. Do not scratch the plastic window. Do not pour the alcohol directly on the plastic window.

Compliance Information, Warnings and Notices

Precautions

⚠ WARNING: LASER LIGHT, DO NOT STARE INTO BEAM: CLASS 2 LASER PRODUCT. FAILURE TO FOLLOW THESE INSTRUCTIONS MAY CAUSE SERIOUS INJURY

- This product is intended for industrial use in automated manufacturing or similar applications.
- The safety of any system incorporating this product is the responsibility of the assembler of the system.
- This product does not contain user-serviceable parts. Do not make electrical or mechanical modifications to product components. Unauthorized modifications can void your warranty.
- This device should be used in accordance with the instructions in this manual.
- CAUTION - Use of controls or adjustments or performance of procedures other than those specified herein may result in hazardous radiation exposure.
- Do not attempt to service or repair this product -- return it to Cognex for service.
- Do not permit anyone other than Cognex Corporation to service, repair, or adjust this product.
- Do not attempt to open or modify this device except as described in this document.
- Do not direct or reflect laser light toward people or reflective objects.
- Do not operate this device if it is damaged or if the covers or seals are missing or damaged.
- IP protection is ensured only when all connectors are attached to cables or shielded by a sealing cap.

This Laser Product is designated as Class 2 during all procedures of operation.

Wavelength	650 nm
Laser Power for classification	< 1mW
Beam Diameter	< 3mm at aperture
Divergence	< 1.5 mrad



Regulations and Conformity

i Note: For the most current CE and UKCA declaration and regulatory conformity information, see the Cognex support site: cognex.com/support.

DataMan 360 and 362 readers have Regulatory Model 1AA4, DataMan 363 readers have Regulatory Model 1ABG and meet or exceed the requirements of all applicable standards organizations for safe operation. However, as with any electrical equipment, the best way to ensure safe operation is to operate them according to the agency guidelines that follow. Please read these guidelines carefully before using your device.

Regulator	Specification
Manufacturer	Cognex Corporation One Vision Drive Natick, MA 01760 USA
USA	FCC Part 15, Class A FDA/CDRH Laser Notice No 50 and 56

Regulator	Specification
Canada	ICES-003, Class A
European Community	EN55022, Class A
	EN55024 EN60950
	EN60825-1
Australia 	Radiocommunications (Electromagnetic Compatibility) Standard: 2017 (EN 55032:2012)
Korea	MSIP-REM-CGX-DM360

Safety and Regulatory	
European Compliance 	<p> WARNING: This is a class A product. In a domestic environment this product may cause radio interference in which case the user may be required to take adequate measures.</p> <hr/> <p>The CE mark on the product indicates that the system has been tested to and conforms to the provisions noted within the 2014/30/EU Electromagnetic Compatibility Directive. For further information please contact: Cognex Corporation, One Vision Drive, Natick, MA 01760, USA . Cognex Corporation shall not be liable for use of our product with equipment (i.e., power supplies, personal computers, etc.) that is not CE.</p>
FCC Class A Compliance Statement 	<p>This equipment has been tested and found to comply with the limits for a Class A digital device, pursuant to Part 15 of the FCC rules. These limits are designed to provide reasonable protection against harmful interference when the equipment is operated in commercial environment. This equipment generates, uses, and can radiate radio frequency energy and, if not installed and used in accordance with the instructions, may cause harmful interference to radio communications. Operation of this equipment in a residential area is likely to cause harmful interference, in which case the user will be required to correct the interference at personal expense.</p>
Canadian Compliance	<p>This Class A digital apparatus complies with Canadian ICES-003. Cet appareil numérique de la classe A est conforme à la norme NMB-003 du Canada.</p>
TÜV	DataMan 360 and 362: Regulatory Model 1AA4 DataMan 363: Regulatory Model 1ABG
	TÜV SÜD SCC/NRTL OSHA Scheme for UL/CAN 61010-1.
	TÜV SÜD, IEC/EN 61010-1. CB report available upon request.

Laser Safety Statement



Compliance with FDA performance standards for laser products except for deviations pursuant to Laser Notice No. 50, dated June 24, 2007.

This device has been tested in accordance with IEC60825-1 3rd ed., 2014., and has been certified to be under the limits of a Class 2 Laser device.



Use of controls or adjustments or performance of procedures other than those specified herein may result in hazardous radiation exposure.

LED Safety Statement

This device has been tested in accordance with IEC62471, and red illumination has been certified to be under the limits of Exempt Risk Group, blue and white illuminations have been certified to be under the limits of Risk Group 1 (Low-Risk). No further labeling is required.

For European Community Users

Cognex complies with Directive 2012/19/EU OF THE EUROPEAN PARLIAMENT AND OF THE COUNCIL of 4 July 2012 on waste electrical and electronic equipment (WEEE).

This product has required the extraction and use of natural resources for its production. It may contain hazardous substances that could impact health and the environment, if not properly disposed.

In order to avoid the dissemination of those substances in our environment and to diminish the pressure on the natural resources, we encourage you to use the appropriate take-back systems for product disposal. Those systems will reuse or recycle most of the materials of the product you are disposing in a sound way.



The crossed out wheeled bin symbol informs you that the product should not be disposed of along with municipal waste and invites you to use the appropriate separate take-back systems for product disposal.

If you need more information on the collection, reuse, and recycling systems, please contact your local or regional waste administration.

You may also contact your supplier for more information on the environmental performance of this product.

Reader Programming Codes



Reset Scanner to Factory Defaults



Reboot Scanner

