

DataMan[®] 475 Verifier Reference Manual

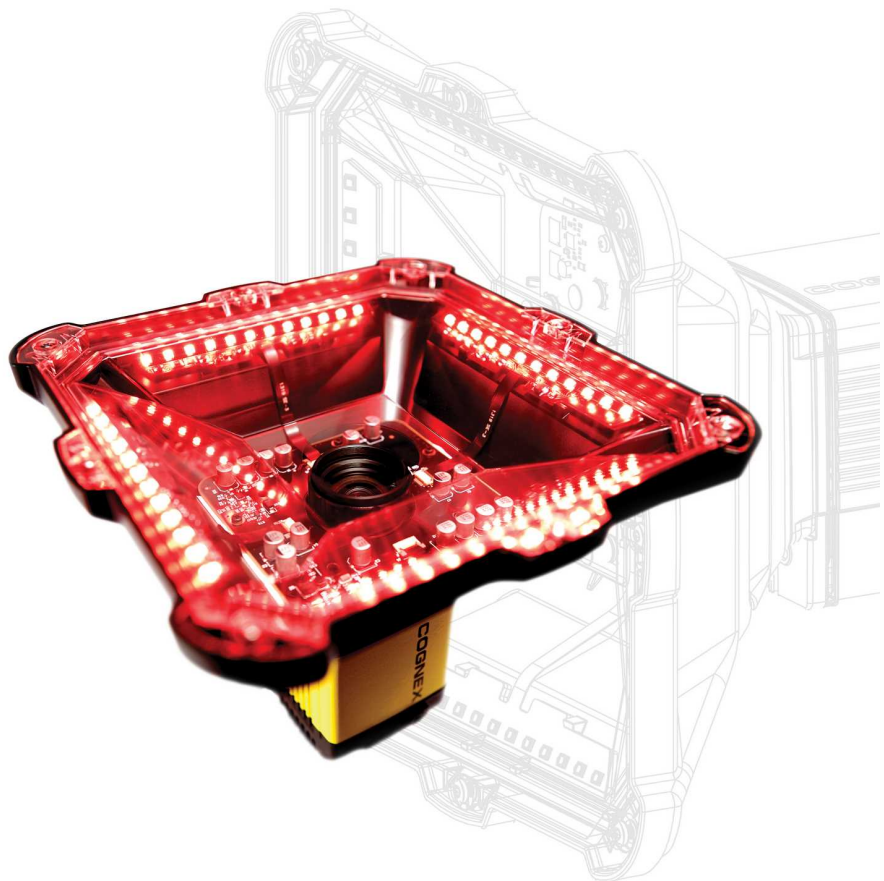

2024 October 21
Revision: 24.3.0.14

Legal Notices

The software described in this document is furnished under license, and may be used or copied only in accordance with the terms of such license and with the inclusion of the copyright notice shown on this page. Neither the software, this document, nor any copies thereof may be provided to, or otherwise made available to, anyone other than the licensee. Title to, and ownership of, this software remains with Cognex Corporation or its licensor. Cognex Corporation assumes no responsibility for the use or reliability of its software on equipment that is not supplied by Cognex Corporation. Cognex Corporation makes no warranties, either express or implied, regarding the described software, its merchantability, non-infringement or its fitness for any particular purpose.

The information in this document is subject to change without notice and should not be construed as a commitment by Cognex Corporation. Cognex Corporation is not responsible for any errors that may be present in either this document or the associated software.

Companies, names, and data used in examples herein are fictitious unless otherwise noted. No part of this document may be reproduced or transmitted in any form or by any means, electronic or mechanical, for any purpose, nor transferred to any other media or language without the written permission of Cognex Corporation.

Copyright © 2024. Cognex Corporation. All Rights Reserved.

Portions of the hardware and software provided by Cognex may be covered by one or more U.S. and foreign patents, as well as pending U.S. and foreign patents listed on the Cognex web site at: cognex.com/patents.

The following are registered trademarks of Cognex Corporation:

Cognex, 2DMAX, Advantage, AlignPlus, Assemblyplus, Check it with Checker, Checker, Cognex Vision for Industry, Cognex VSOC, CVL, DataMan, DisplayInspect, DVT, EasyBuilder, Hotbars, IDMax, In-Sight, Laser Killer, MVS-8000, OmniView, PatFind, PatFlex, PatInspect, PatMax, PatQuick, SensorView, SmartView, SmartAdvisor, SmartLearn, UltraLight, Vision Solutions, VisionPro, VisionView

The following are trademarks of Cognex Corporation:

The Cognex logo, 1DMax, 3D-Locate, 3DMax, BGAll, CheckPoint, Cognex VSoC, CVC-1000, FFD, iLearn, In-Sight (design insignia with cross-hairs), In-Sight 2000, InspectEdge, Inspection Designer, MVS, NotchMax, OCRMax, PatMax RedLine, ProofRead, SmartSync, ProfilePlus, SmartDisplay, SmartSystem, SMD4, VisiFlex, Xpand

Portions copyright © Microsoft Corporation. All rights reserved.

Portions copyright © MadCap Software, Inc. All rights reserved.

Other product and company trademarks identified herein are the trademarks of their respective owners.

Table of Contents

Legal Notices	2
Table of Contents	3
Symbols	6
Getting Started	7
About the DataMan 475 Verifier	7
Supporting Documentation	7
DataMan 475 Verifier Accessories	8
Cables and Power Supply	8
Mounting Brackets	9
Calibration Cards	10
DataMan 475 Verifier Systems	10
Setting Up DataMan Setup Tool	11
Verifying Your First Code	11
External Triggers	13
User Interface	14
Toolbar	14
Calibration	16
Calibrate the DataMan 475 Verifier	16
Supported NIST Calibration Symbols	18
Calibration Frequency	18
Guided Focus Feedback	20
Settings	24
Settings Menu	24
Application Settings	24
Application Standards Settings	26
GS1	27
UID (MIL-STD-130)	28
UDI (GS1 or HIBCC)	29
Auto	29
Cryptocode	30
Custom	30
Dot Peen	34
Min X-Dimension (mils)	34
Max X-Dimension (mils)	34
Pass Grade	34
Grading Standards	34
Calibration Settings	35
Trending Settings	35
User Information	36

Report Settings	37
Navigation	37
Results through Setup Tool (local machine)	38
Result Type	38
Result Formatting/Scripting	39
Results through FTP	39
Image FTP Settings	39
Result FTP Settings	40
Report (scripting) FTP Settings	40
Symbologies/Multi Mode	41
Symbologies/Number of Symbols	41
Scripting	41
Setting Up FTP Transfer	42
Image FTP Transfer	43
Result FTP Transfer	43
Report FTP Transfer	44
Saving Reports	45
Set Date and Time	46
Using Your DataMan 475 Verifier	49
Verifying a 1D Barcode	49
Verifying a 2D Barcode	49
Selecting Regions	50
Examining the Results	52
1D & 2D Verification	52
Main Tab	52
General Characteristics Tab	53
Data Detail Tab	54
Modulation Table Legend	56
Quality Detail Tab	56
Advanced Detail Tab	57
Histogram Tab	58
Report Tab	59
Standards Based Grading	60
Verifications of Multiple Symbols	61
Cleaning and Maintenance	63
Cleaning the Verifier Housing	63
Cleaning the Verifier Lens Cover	63
Setting Up Your DataMan 475 Verifier	64
Reader Layout	64
Dimensions	66
DataMan 475 Verifier Label Light	66
DataMan 475 Verifier DPM	66
DataMan 475 Verifier HD	67

Removing Illumination Attachment	68
Additional Information	72
DataMan 475 Verifier Specifications	72
DataMan 475 Series Verifier Imager Specifications	74
LED Wavelengths	75
Compliance Information, Warnings and Notices	76
Precautions	76
Regulations/Conformity	77
For European Community Users	77

Symbols

The following symbols indicate safety precautions and supplemental information:

 **WARNING:** This symbol indicates a hazard that could cause death, serious personal injury or electrical shock.

 **CAUTION:** This symbol indicates a hazard that could result in property damage.

 **Note:** This symbol indicates additional information about a subject.

 **Tip:** This symbol indicates suggestions and shortcuts that might not otherwise be apparent.

Getting Started

This section provides general information about the DataMan 475 Verifier and the DataMan 475 Verifier accessories and systems.

About the DataMan 475 Verifier



The DataMan 475 Verifier provides immediate quality assurance benefits:

- Sets alerts for when code quality begins to degrade
- Grades up to 20 codes per second
- Exports verification results to PLC, database, or FTP server as CSV, HTML, PDF, and custom formats
- Improves processes with detailed analysis and diagnostic information for every code

The DataMan 475 Verifier Label Light uses a four-quadrant, 45-degree lighting attachment. The DataMan Verifier 475 DPM and DataMan Verifier 475 HD use either a four-quadrant 30-degree, 45-degree, or 90-degree lighting attachment. Both types of 475 verifiers are compliant with the International Organization for Standardization (ISO/IEC) requirements for grading 1D and 2D label-based barcodes. The included calibration card and robust grading algorithms ensure that the DataMan 475 Verifiers conform to ISO/IEC and application standards while providing accurate and repeatable results.

The DataMan 475 Verifiers are packaged in a rugged, IP65-rated housing, and provide numerous ease-of-use features, including one button to trigger and one button to start tuning.

Supporting Documentation

This document provides basic information about how to configure and use the DataMan 475 Verifier. Additional information is available through the Windows **Start** menu or the DataMan Setup Tool **Help** menu once installing the DataMan software on your PC:

- The **DataMan Communications and Programming Guide** shows you how to integrate your DataMan verifier into your particular automation and factory environment.

Cognex->DataMan Software v x.x.x->Documentation->Communications->DataMan Communications and Programming Guide

- The **DataMan Industrial Protocols Manual** provides information on how to integrate DataMan verifier into your particular environment using industrial protocols.

Cognex->DataMan Software v x.x.x->Documentation->Communications->DataMan Industrial Protocols Manual

- The **DataMan Reader Configuration Codes** document provides printable 2-D codes that you can use to configure the DataMan verifier.
Cognex->DataMan Software v x.x.x->Documentation->English->Reader Configuration Codes
- The **DataMan 475 Verifier Quick Reference Guide** provides essential information about the DataMan 475 Verifier.
Cognex->DataMan Software v x.x.x->Documentation->English->DM475V Series->DM475V Quick Reference Guide
- The **DataMan Fixed-Mount Readers Reference** is a complete online hardware reference for the DataMan fixed-mount ID verifier.
Cognex->DataMan Software v x.x.x->Documentation->English->DM475V ->Fixed-Mount Reference Manual
- The **DataMan Control Commands** lists DataMan Control Commands with all relevant information. You can view this help inside the Setup Tool or as a stand-alone help file.
Cognex->DataMan Software v x.x.x->Documentation->English->DataMan Control Commands
- The **Setup Tool Reference Manual** describes the user interface of the DataMan Setup Tool software.
Cognex->DataMan Software v x.x.x->Documentation->English->Setup Tool Reference Manual
- The **Release Notes** list detailed system requirements and additional information about this DataMan software release.
Cognex->DataMan Software v x.x.x->Documentation->DataMan v x.x.x Release Notes
- The **Introduction to Barcode Verification** page provides information about the grading standards.
<https://www.cognex.com/what-is/barcode-verification>

DataMan 475 Verifier Accessories



Note: For ISO/IEC compliant verification, equip the DM475V with DMV-475V-LBL-0200, DMV-475V-DPM-0100, or DMV-475V-HD lighting accessories. Use other light accessories for DM475V for Standards Based Grading only.





Note: The product images below serve illustration purposes only. You can purchase the following components separately. For a list of options and accessories, contact your local Cognex sales representative.

Cables and Power Supply





Note: Cables are sold separately.

CAUTION: All cable connectors are keyed to fit the connectors on the verifier. Do not force the connections or damage may occur.

Accessory Name	Accessory Product Number	Accessory Illustration
Power and I/O Breakout Cable, M12-12 to Flying Lead	CCB-PWRIO- xx (straight, xx specifies length: 5m, 10m, 15m) CCB-PWRIO-xxR (right-angled, xx specifies length: 5m, 10m, 15m)	
X-Coded to A-Coded Ethernet cable adapter, 0.5 m	CCB-M12X8MS-XCAC	

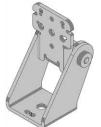
Accessory Name	Accessory Product Number	Accessory Illustration
Ethernet Cable, X-coded M12-8 to RJ-45	CCB-84901-2001-xx (straight, xx specifies length: 2m, 5m, 10m, 15m, 30m)	
I/O extension cable, straight, 5 m	CKR-200-CBL-EXT	
Connection module (up to 4 cameras including network switch) xx can be EU, UK, or JP	DMA-CCM-4X-xx	
Connection module (1 camera) xx can be US, EU, UK, or JP	DMA-CCM-1-xx	
Power supply and cable kit (includes US and EU power supplies)	DMV-PS-02	

Mounting Brackets

Accessory Name	Accessory Product Number	Accessory Illustration
Mounting Bracket Kit	DMBK-470-MNT	
Pivot Mounting Bracket	DM100-PIVOTM-00	
External Heat Sink	DMHS-370-470	
Stand Accessory	DMV-FMOL-STAND	
Label Light Mounting Bracket	DMV-BRK-475LBL	
Stand Extension Arm	DMV-BRK-STANEXT	

Calibration Cards

Product ID	Description	Image
DMV-AICC	<p>Applied Image #AI-CCS-UPC/EAN 6mil Calibration and Conformance Test Card:</p> <ul style="list-style-type: none"> • Similar to discontinued GS1 EAN/UPC Calibration Card. • Provides conformance testing on 1D barcodes. • Provides traceability through an ISO 17025 accredited lab. • This card is produced by an ISO 17025 accredited lab. 	
DMV-DMCC	<p>Applied Image Data Matrix Calibration and Conformance Test Card:</p> <ul style="list-style-type: none"> • Similar to discontinued GS1 Data Matrix Calibration Card. • Provides traceability through an ISO 17025 accredited lab. • This card is produced by an ISO 17025 accredited lab. <div style="border: 1px solid black; padding: 5px; margin-top: 10px;"> <p>Note: The barcode symbols on this card contain encoded data that is generic and not GS1 formatted, but this is not relevant for calibration purposes.</p> </div>	
DMV-CCC	<p>Cognex Standard Calibration Card contains Master Grade 1D and 2D symbols:</p> <ul style="list-style-type: none"> • For calibration only. Does not contain any ISO/IEC 15426 conformance test symbol. • Provides traceability, but not to an accredited ISO 17025 lab. 	

DataMan 475 Verifier Systems

System Name	Symbologies	Light Configurations	Verification Standards	Illustration
DMV-475V-LBL-0200	1D, 2D, DPM	45° Label Light	ISO/IEC 15415, 15416, 29158	
DMV-475V-DPM-0100	1D, 2D, DPM	30°, 45°, 90° DPM	ISO/IEC 15415, 15416, 29158	
DMV-475V-HD	1D, 2D, DPM	30°, 45°, 90° DPM	ISO/IEC 15415, 15416, 29158	

Setting Up DataMan Setup Tool

This section provides information on the installation process of the DataMan Setup Tool and external triggers.

Verifying Your First Code

Follow the steps below to install and connect your verifier to the DataMan Setup Tool:

1. Download the latest version of the DataMan Setup Tool from <http://www.cognex.com/support/dataman> and follow the on-screen steps.
2. Check the DataMan **Release Notes** for a full list of system requirements found at C:\Program Files (x86)\Cognex\DataMan\DataMan Software <version>\Documentation\English.
3. Connect the DataMan 475 Verifier to your PC using the x-coded Ethernet cable and power the reader using the breakout cable.
4. Launch the DataMan Setup Tool and click **Refresh**.

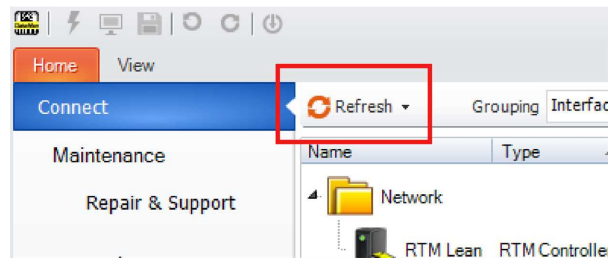

Note: Detected readers appear under **COM ports** or **Network devices**, or both.

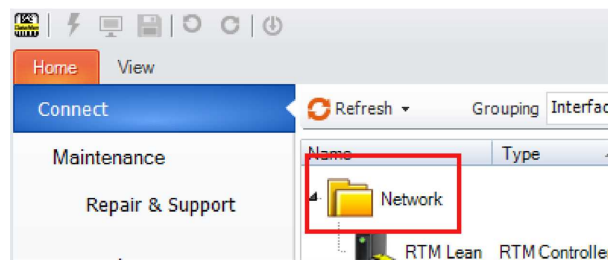

If the verifier does not appear in the list of devices, you can use either the **Add Device** or **Force Network Settings** options in the DataMan Setup Tool under **Repair & Support**. For more information, see the DataMan *Setup Tool Reference Manual*.

5. Select a verifier from the list and double click it or click **Connect**.

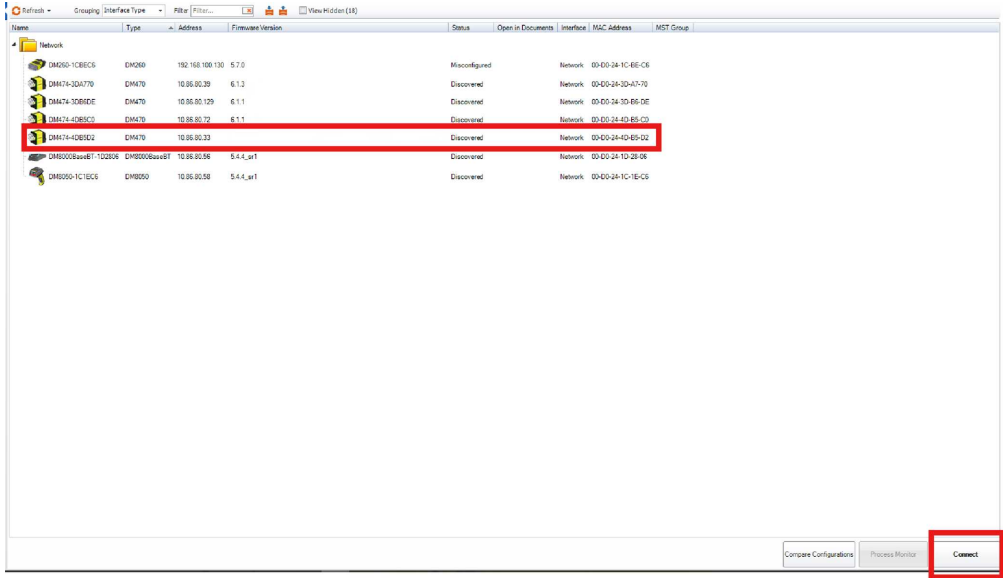

6. After connecting, the TruCheck window automatically opens.

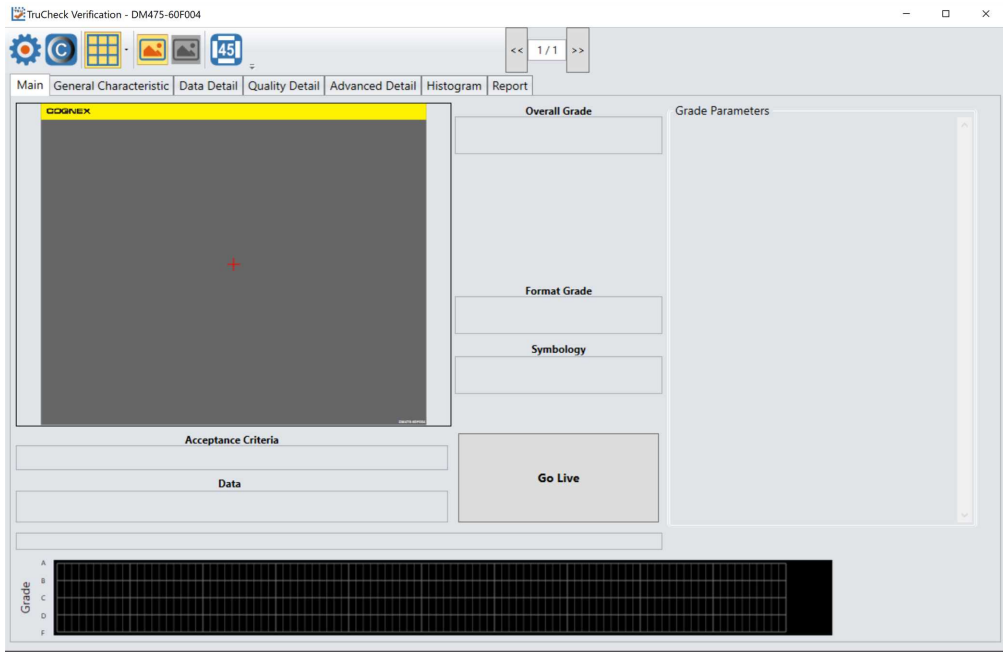

Note: If TruCheck window does not open or needs to be re-opened at any point during verification, select the TruCheck window icon under the **View menu on the ribbon bar** in Setup Tool.

Note: If you are running the DM475V at line speed, you may need to disconnect Setup Tool and obtain results through the device output interface.

WARNING: Do not stare into the beam when adding, removing, or changing cables. Cognex recommends disconnecting the verifier from power whenever you make physical changes to it.

Follow the steps below to connect your reader to power and network:

CAUTION: Make sure that the verifier is not receiving power before you perform any I/O wiring or adjustments to I/O devices.

CAUTION: Make sure that the Ethernet cable is grounded at the far end. Whatever this cable is plugged into (usually a switch or router) should have a grounded Ethernet connector. Use a digital voltmeter to validate the grounding. If the far end device is not grounded, add a ground wire in compliance with local electrical codes.

1. Connect the I/O+RS232+24 V cable to your reader.
2. Connect your reader through an Ethernet cable to your network for a network connection.
3. Connect the cable to a 24 V power supply.

External Triggers

If you are using external triggering, you can use any of the following methods to trigger your DataMan 475 Verifier :

- Press the trigger button on the reader.
- Send a pulse on the I/O cable:
 - Trigger + (orange or red)
 - Trigger - (black)
- Send a serial trigger command over the RS-232 connection connection.
- Press <CTRL-T> on the keyboard while the DataMan Setup Tool has the input focus.
- Click the **Trigger** button in the DataMan Setup Tool:

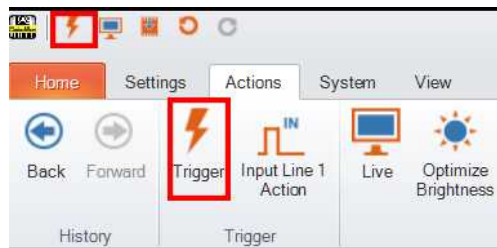





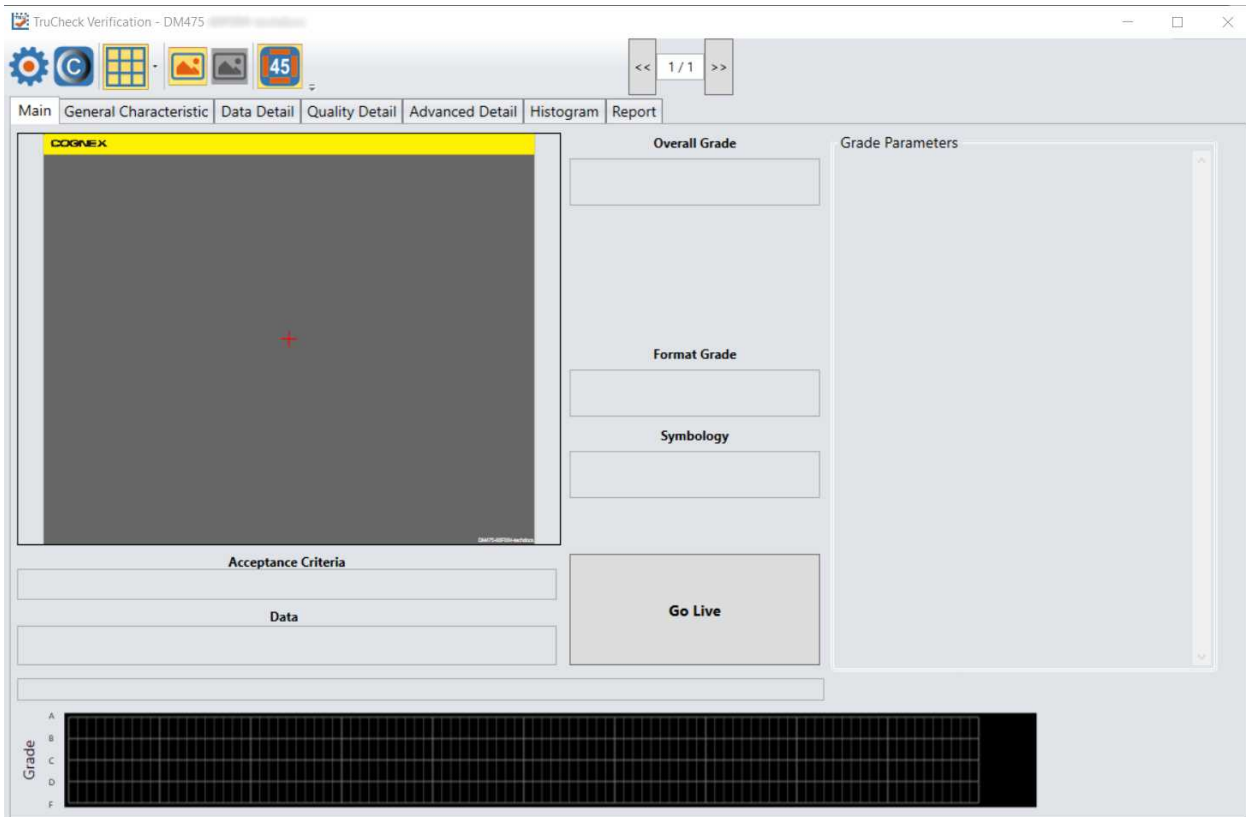





User Interface

This section describes the settings and options of the TruCheck Verification window.



Toolbar

Icon	Function
	Settings: Opens up the settings menu allowing changes in the Application Settings, Calibration Settings, Trending Settings, User Information, Report Settings, and Navigation menus. For more information, see Settings on page 24 .
	Calibration: Opens up the calibration window to calibrate the unit. For more information, see Calibration on page 16 .
	Grid & Modulation Circles: Select Grid & Modulation Circles to apply a grid or a modulation circle to the image after verification. Use the drop-down menu to apply a Real Grid, an Ideal Grid, or both. Select Mod Circles Filled or Mod Circles Outlined options according to your needs.
	Original Image: Shows the image as the imager has acquired the image before post processing.

Icon	Function
	<p>45° illumination: Enables 45° illumination. 45° four-sided illumination is used primarily for labels. 45° illumination is either not reported or reported as 45Q. If the system does not report illumination, it is assumed to be 45Q.</p> <p>Note: This lighting option is available on the DataMan 475V, the 475V DPM, and 475V HD.</p>
 	<p>Select this icon for 30° two-sided illumination. 30° two-sided illumination can be from either the North/South or East/West. 30° two-sided illumination is useful on cylindrical surfaces. Select the sides in parallel to the axis of the cylinder. This illumination is reported as 30T.</p> <p>Note: This lighting option is available on DataMan 475V DPM and 475V HD.</p>
	<p>Select this icon to use one side of the 30° lighting. Use the drop down menu to select one of the four sides for 30° lighting. If you select this lighting option but you do not select any individual lighting side, the software uses top 30° lighting. The system reports one side 30° illumination as 30S.</p> <p>Note: This lighting option is available on DataMan 475V DPM and 475V HD.</p>
	<p>Select this icon to use four side 30° illumination. Four side 30° illumination reduces glare from some substrates, which cause poor Symbol Contrast or Modulation grading. The system reports four side 30° illumination as 30Q and is used primarily for DPM applications.</p> <p>Note: This lighting option is available on DataMan 475V DPM and 475V HD.</p>
	<p>Select this icon for 90° specular illumination. 90° specular illumination works well on very shiny substrates and Dot Peen Applications. 90° specular illumination is reported as 90.</p> <p>Note: This lighting option is available on DataMan 475V DPM and 475V HD.</p>

Calibration

Calibration informs the verifier about the grey scale levels of the verifier, telling it the most extreme dark and light values. This way, the verifier can establish a baseline to compare codes being verified and report a value for Symbol Contrast. In addition, this process also informs the verifier about pixel dimensions so that verifier can report X-dimension values.

For ISO compliant barcode verification, make sure that the verifier is in a calibrated state.

Calibration should be performed using a NIST traceable calibration card. See the [Supported NIST Calibration Symbols on page 18](#) listed below.

For Standards Based Grading, the verifier does not report all quality parameters without calibration.

In an uncalibrated state, the verifier does not report the following:

- Aperture and Symbol Contrast (SC) for ISO/IEC 15415/15416 applications
- Minimum Reflectance (MR) for ISO/IEC TR29158 (AIM-DPM) applications

Note: In an uncalibrated state, the verifier does not report aperture value, but uses the default aperture selection: Auto 50% for 1D applications or Auto 80% for 2D applications.

Calibrate the DataMan 475 Verifier

1. Click the **Calibration** icon in the top left corner in the TruCheck Verification window.
2. Enter the **Rmax** and **Rmin** values from the calibration card.

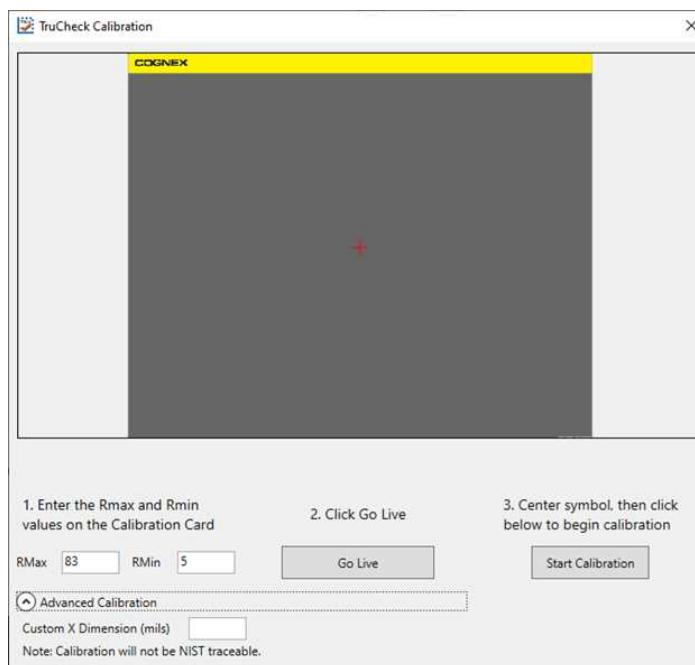

TruCheck Calibration

COGNEX

1. Enter the Rmax and Rmin values on the Calibration Card

2. Click Go Live

3. Center symbol, then click below to begin calibration

RMax: RMin:

Advanced Calibration

Custom X Dimension (mils)

Note: Calibration will not be NIST traceable.

Use the Advanced Calibration option only if you use a non-NIST traceable calibration symbol. This option allows you to enter the Custom X-Dimension (mils) value of the barcode that you use to calibrate the unit. The calibration process uses the Custom X-Dimension (mils) value to calibrate dimension measurements.

3. Click **Center Target**.
4. A live image appears in the **Calibration** screen. Center the verifier over the calibration symbol.

5. Clicking **Start Calibration** prompts a Calibrating progress bar appear in the window



6. If the calibration is successful, one of two messages pop-up.

If you performed the calibration with one of the supported NIST-traceable calibration symbols, the pop-up displays the following:

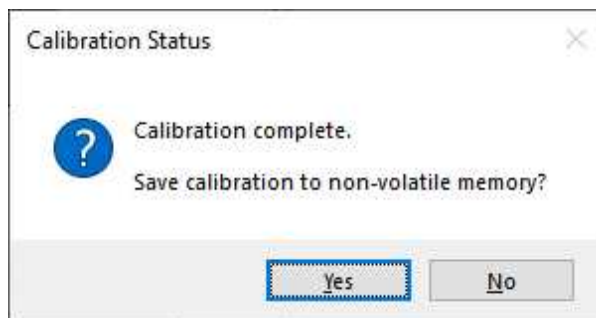

When you perform a successful calibration with a supported NIST-traceable calibration symbol, a calibration time date stamp appears on the bottom of the TruCheck window and is printed in the header of the report. For the list of NIST-traceable calibration symbols, see the step list.

If you performed the calibration successfully with any readable symbol other than the supported NIST-traceable calibration symbols, the pop-up displays the following:

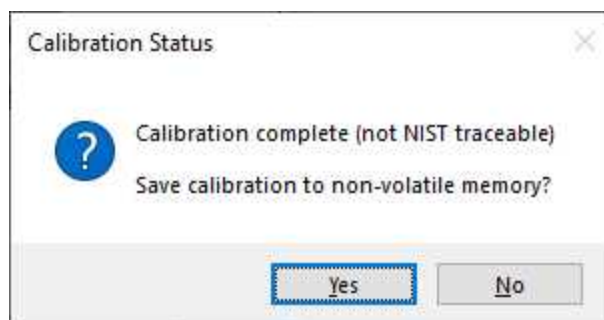

If you perform a successful calibration with a non NIST-traceable calibration symbol, no calibration date is recorded on the reports or displayed on the Main tab in the TruCheck window. Instead, the message reads "Calibration Complete (not NIST-traceable)".

If the calibration failed, see step 8.

7. For both successful calibration messages, you have the options to **Save Calibration** to non-volatile memory

If you select **Yes**, the unit saves the calibration for subsequent verifications and the values to non-volatile memory. If you power down the unit, the calibration persists.

If you select **No**, the unit saves the calibration for subsequent verifications but does not save the values to non-volatile memory. If you power down the unit, the calibration values are lost.

8. If the calibration failed, the pop-up displays the following message:

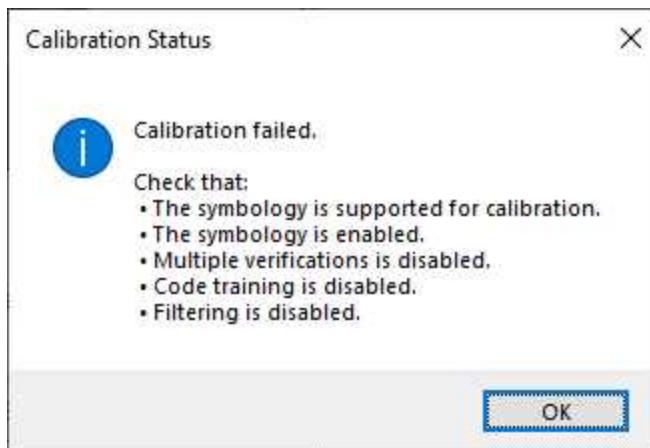

A failed calibration means that the calibration target was not detected. Ensure that:

- A valid, readable barcode is visible within the field of view and in focus.
- You have selected the region of interest that includes the barcode that you use for calibration.
- The calibration barcode symbology type is supported.
- The calibration barcode symbology type is enabled in **Code Details** tab in the **Setup Tool** window.
- The unit is not set for multiple verifications.
- No filtering is enabled.

Supported NIST Calibration Symbols

Note: Store the calibration card away from direct light to avoid compromising the calibration symbol.

- 1D and 2D symbols on the Cognex Calibration Card (Cognex #DMV-CCC)
- Symbols 1 and 5 on the Applied Image Conformance Calibration Standard Enhanced Test Card for ISO IEC Datamatrix and GS1 Datamatrix (Cognex #DMV-DMCC)

Note: For the DM475V-HD, Cognex recommends to use Symbol 5 for calibration because it is a small X-dimension barcode. For all other verifiers, Cognex recommends to use Symbol 1 for calibration.

- Symbol 1 on the GS1 ISO/IEC Data Matrix & GS1 Datamatrix Calibrated Conformance Standard Test Card (Cognex #DMV-GS1CC)
- EAN-13 MASTER GRADE and UPC-A MASTER GRADE symbols on the GS1 Calibrated Conformance Standard Test Card for EAN/UPC Symbol Verifiers (Cognex #DMV-AICC)

Calibration Frequency

Calibrate your verifier as needed to ensure accurate verification results. Monthly calibration is recommended, or more frequently where required by internal quality guidelines.

Enable a calibration reminder in Calibration Settings to alert you about the next scheduled calibration. After enabling the calibration reminder, set the number of days for prompting a calibration reminder. For more information, see [Calibration Settings on page 35](#).

Tip: Click **Discard Calibration** to remove all calibration values and return the verifier to an uncalibrated state.

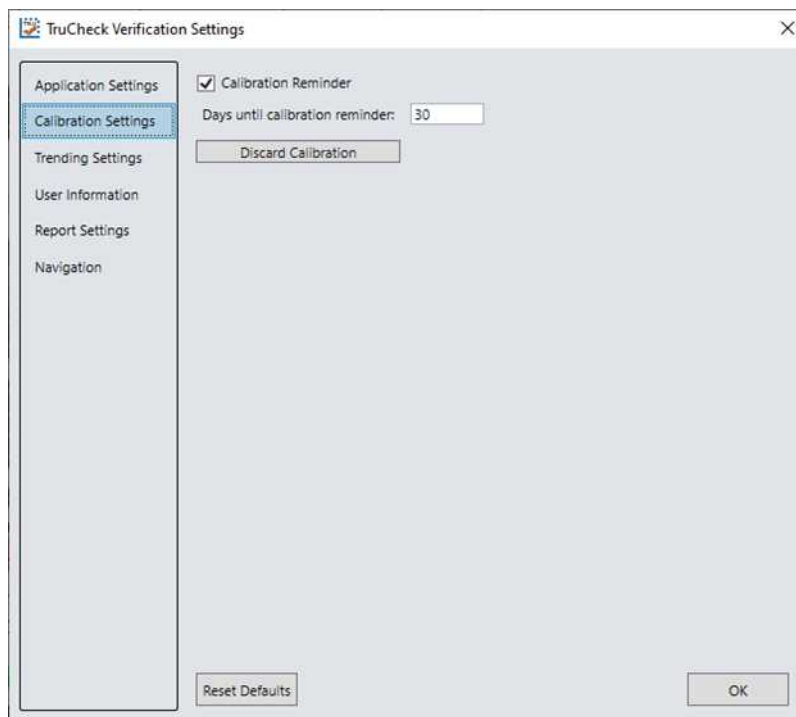

Guided Focus Feedback

Guided Focus Feedback is a feature that shows you which way to turn the hand wheel of the Stand accessory to position the verifier at the proper height for optimal focus on the barcode. You can enable or disable the Guided Focus Feedback in Live Mode. Failure to properly focus the verifier results in skewed results or failure in decode quality.

To use Guided Focus Feedback, perform the following steps in the Setup Tool window:

1. Select **Optimize Image**.
2. Expand the drop down menu under **Live**. Enable **Decoding** and **Guided Focus Feedback** in Live Mode. You must enable **Decoding** for Guided Focus Feedback to work correctly.

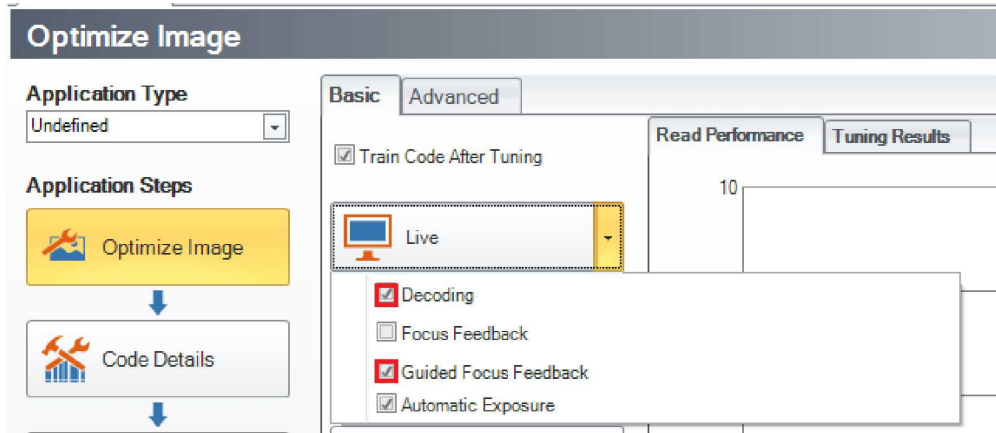

Note: Guided Focus Feedback overrides Focus Feedback if it is enabled. You do not need to enable both.

Guided Focus Feedback appears in the TruCheck window to the right of the image. When you enter the Live Mode for the first time, the guidance indicator displays an up and down arrow indicating that you should begin moving in either direction.

Note: If the Guidance Focus Feedback icons do not appear, click the **Go Live** button. You may need to close and reopen the TruCheck window.

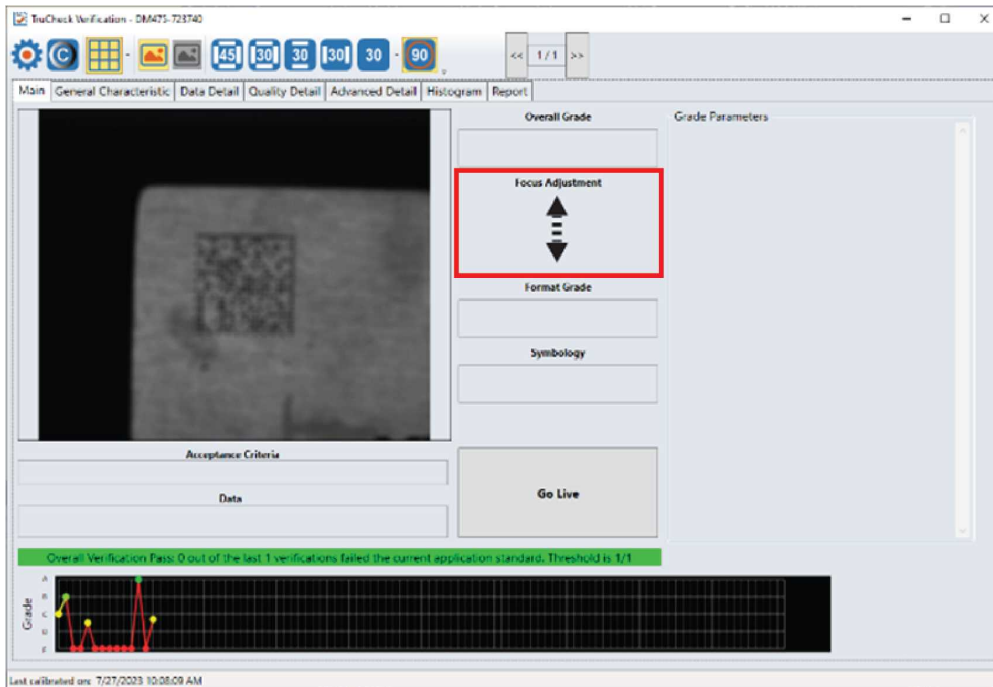

3. Move the verifier closer to or further from the target to make the image sharper so it can detect the code.

The guidance indicator is now a green or yellow arrow. Once the code is detected, the guidance indicator shows the best direction to move the Stand handle of the Stand accessory to improve focus. The sharpness value appears below the guidance indicator. As the image becomes sharper, the sharpness value increases.

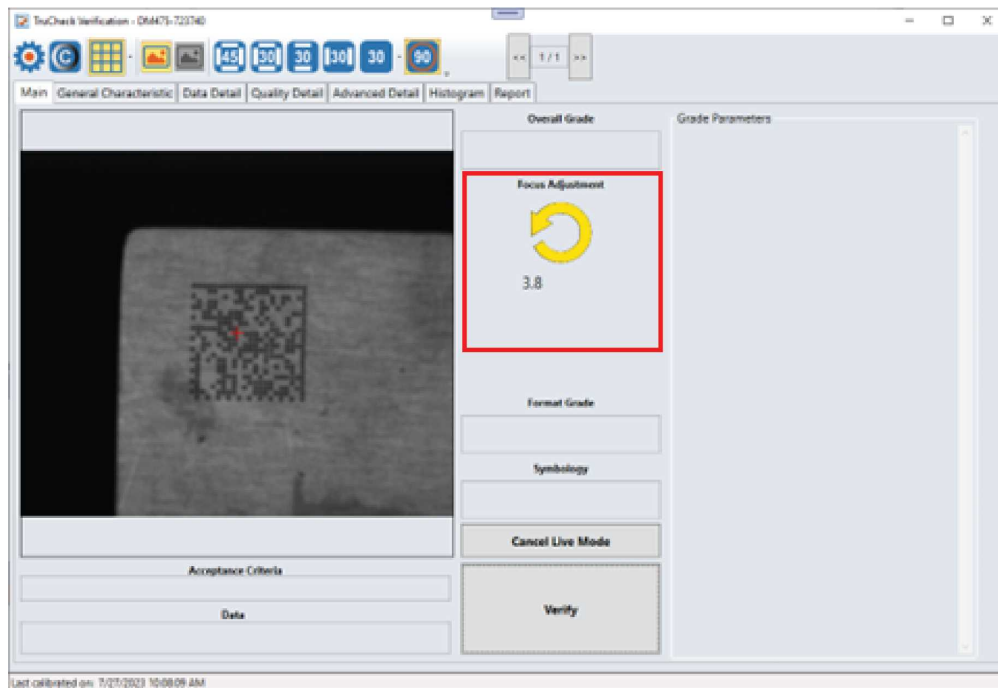

- As you continue to adjust the focus, the sharpness value will reach a maximum "peak" value and then decreases as you go past the point of best focus. At this point, the guidance indicator turns green and the peak sharpness value also appears. The guidance indicator shows which direction is the best focus position. As you adjust, the current sharpness value approaches the peak sharpness value.

Note: Adjust the position very slowly at this point.

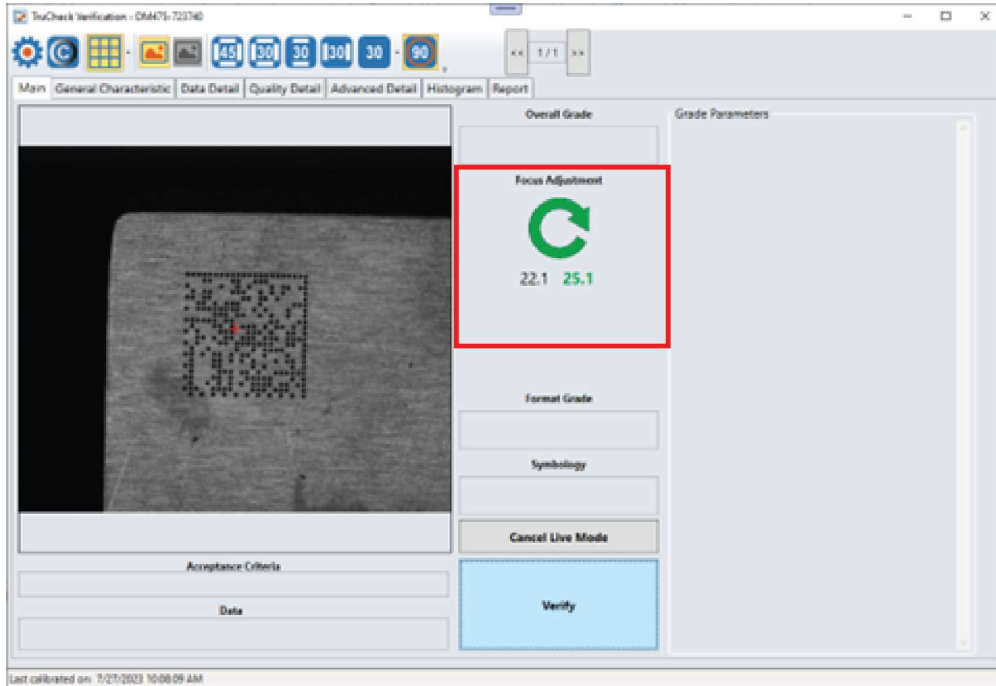

- When the verifier is in the best focus position, the sharpness score and the peak sharpness score are very close, and the good focus checkmark appears. Verify your code now.

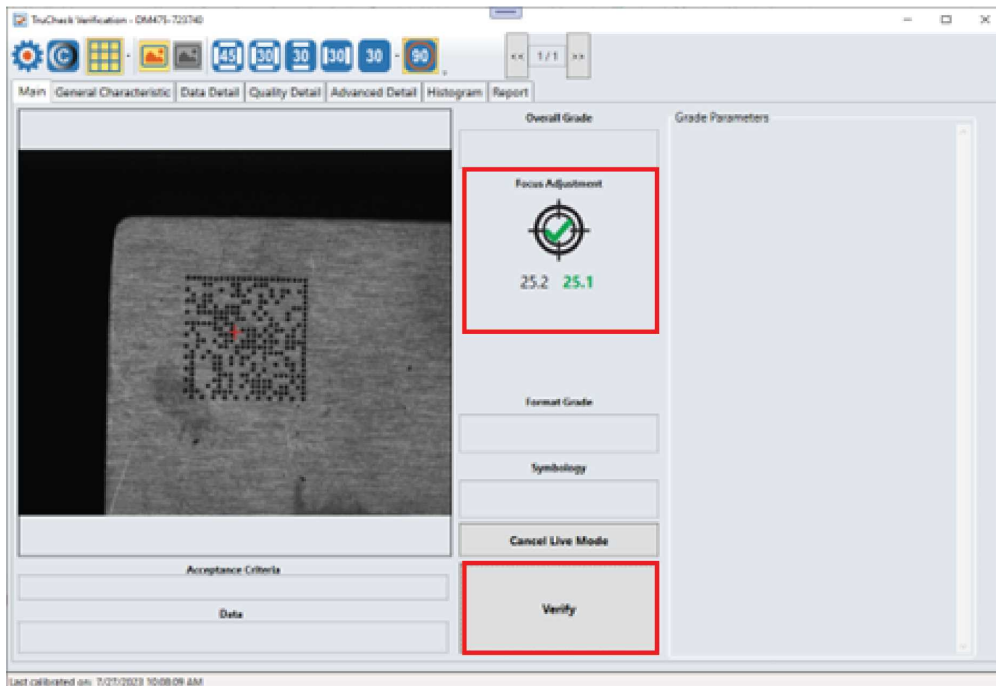

Note:

- When you start to setup the verifier, move the verifier close to focus by trial and error. The verifier does not know if the out-of-focus image is due to the verifier being too close or too far from the image, so it cannot tell you which direction to go. Once the verifier detects the code, the verifier can tell you which direction to move the verifier. This is why the directional guidance does not appear until you successfully move the verifier close enough to detect a code.



- The verifier can get confused if the texture in the image is too complicated or if you move in the opposite direction than the verifier suggests. Always use your judgment to determine whether the image is truly in focus.
- Adjust slowly to improve the accuracy of the guidance.
- If you are not using the Stand accessory but you want to use Guided Focus Feedback, you can select alternate guidance indicators by double-clicking **Focus Adjustment**.

Settings

This section describes the settings and the options available in the **TruCheck Verification** window.

Settings Menu

To access **Settings**, select **Settings** in the upper left corner of the **TruCheck Verification** window.

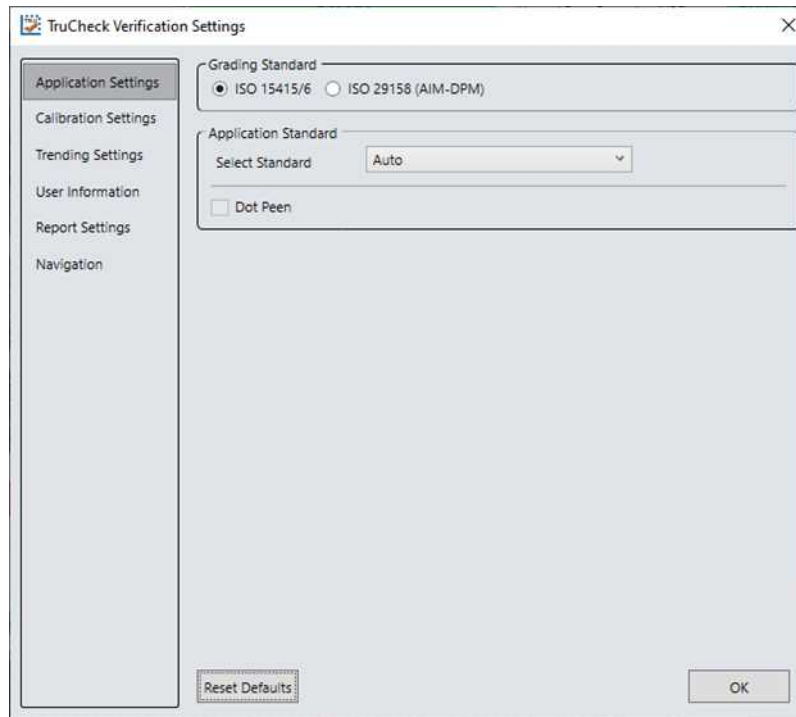

Application Settings

The content of the **Application Settings** window depends on which **Application Standard** you select. The application standard setting automatically sets many of the parameters.

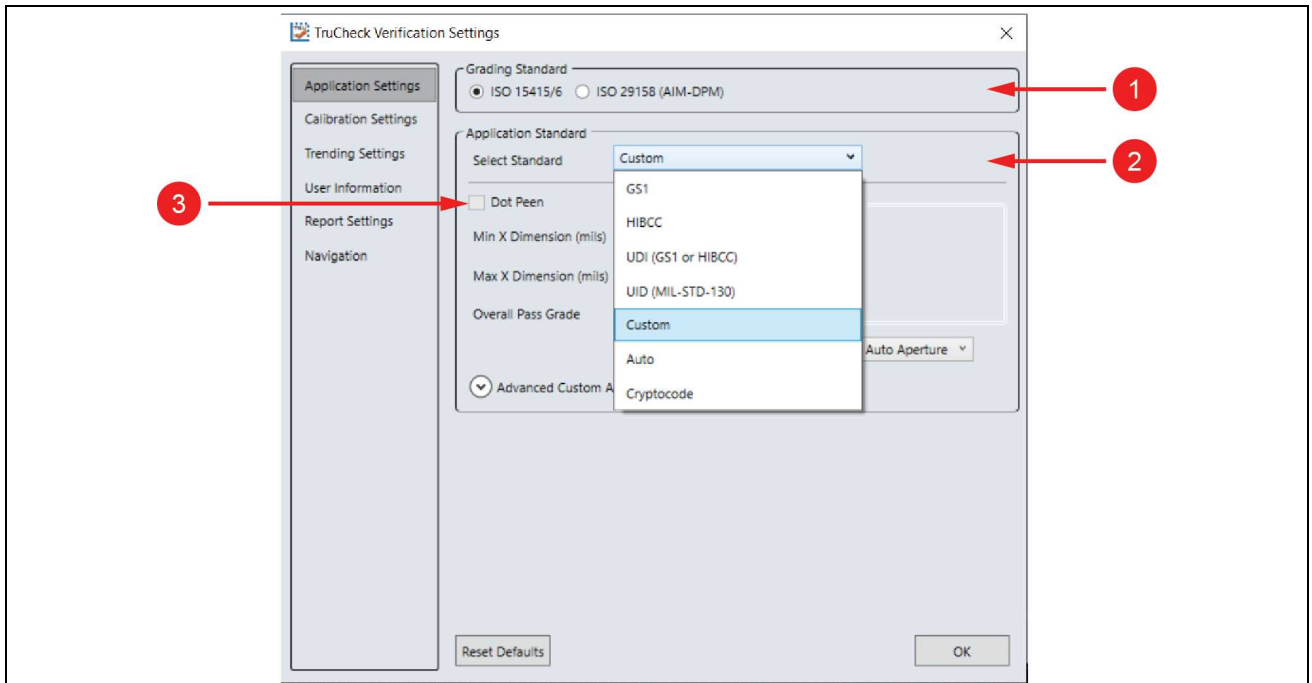

Number	Element	Description
1	Grading Standard	<p>For any Application Standard selected, you need to select a Grading standard, depending on your application. For more information, see Grading Standards on page 34.</p> <p>Available options are:</p> <ul style="list-style-type: none"> • ISO/IEC 15415:2011 for 2D barcodes • ISO/IEC 15416:2016 for 1D barcodes • ISO/IEC 29158:2011 or 2020 for DPM barcodes
2	Application Standard	<p>You can select pre-defined and custom application standards. Application standards are detailed barcode guidelines for a specific industry listing rules for allowed code types, sizes, placement, and data formats. For more information, see Application Standards Settings on page 26</p> <ul style="list-style-type: none"> • Selecting a pre-defined application standard ensures that the DM475 Verifier uses the appropriate grading parameters for your application. • Custom application standard allows you to customize all adjustable verification and process parameters. • Auto application standard setting allows the software to automatically select the appropriate application standard based on the data formatting in the code being verified.

Number	Element	Description
3	Dot Peen	The Dot Peen option helps you connect dots in case of codes created through a process where dots are peened onto a metal surface. Select Dot Peen to use the AIM-DPM Stick algorithm to connect dots. For more information, see in Dot Peen on page 34 .

The **Reset Defaults** button resets the **Application Settings** menu to the default settings (Auto).

After clicking **Reset Defaults**, you must calibrate the verifier before using it. For more information, see [Calibration on page 16](#).

Application Standards Settings

Application Standards configure the verifier to grade according to pre-defined rules established by an industry standards body or other industry requirements.

Select one of the options provided in the drop down box to specify the application standard.

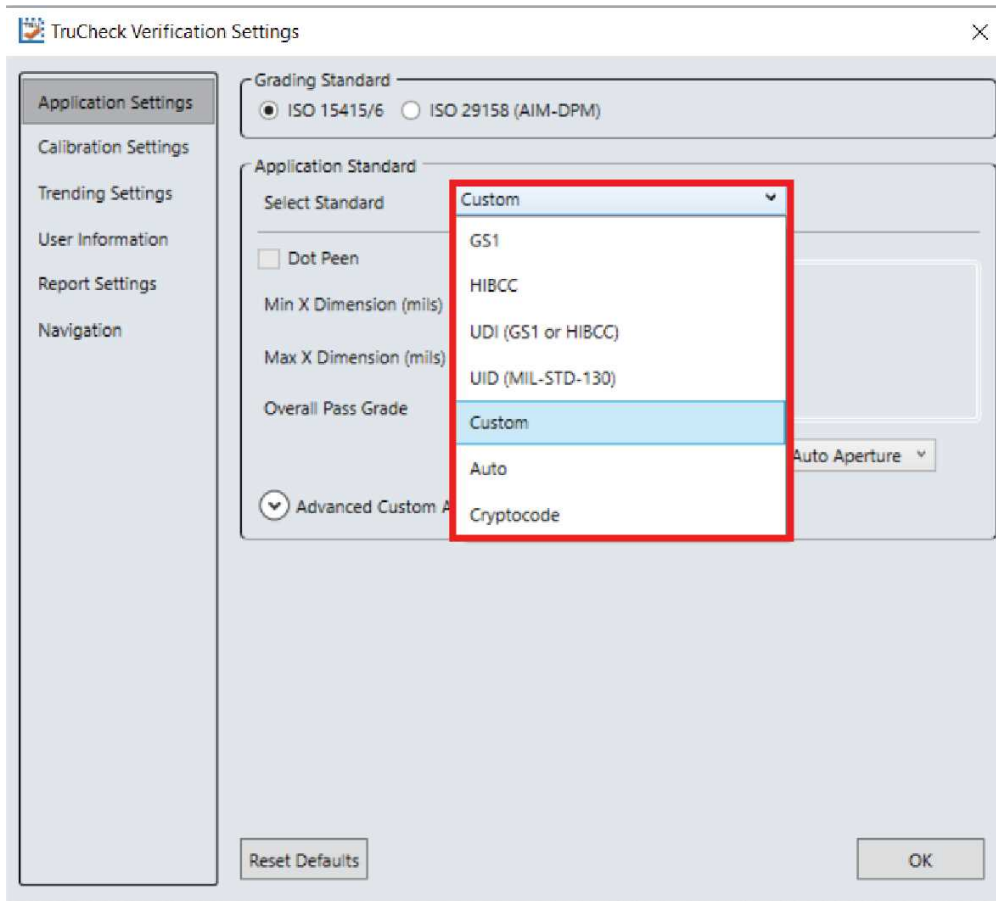

The available options are:

- Pre-defined
 - GS1
 - HIBCC
 - UDI (GS1 or HIBCC)
 - UID (MIL-STD-130)
 - Auto
 - Cryptocode
- Custom

GS1

GS1 application standard follows GS1 General Specification guidelines in code verification. GS1 General Specification Tables 1-11 describe several categories of applications. Select from the tables to specify the application category for your codes.

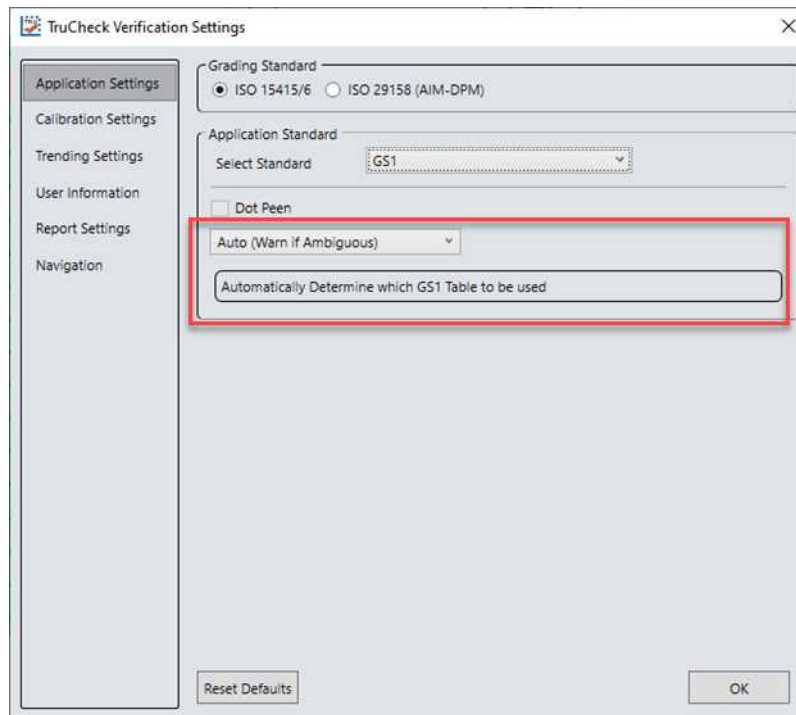

If you select **Auto (Warn if Ambiguous)**, the most applicable General Specification Table is automatically selected for you.



The selected GS1 table is available in the **Notes** section of the report. For more information on the tables used for analysis, see [GS1 General Specifications Standard](#).

Select **Dot Peen**, if applicable.



Note: The DataMan 475 Verifier uses the X-dimension of the decoded symbol to deduce which table applies. If the X-dimension is outside the range allowed in your application, results are incorrect. To make sure that the verifier checks all the correct requirements for your application, select the table in the GS1 General Specifications that applies to your application.

UID (MIL-STD-130)

The UID (MIL-STD-130) application standard reports the quality standard according to the MIL-STD 130 specifying UID marks Construct 1 and Construct 2 that use data structure and code grade for verification. The MIL-STD 130 spells out acceptable grades and requirements for data format.

Specify either the ISO/IEC 15415 grading or the ISO/IEC 29158 (AIM-DPM) grading for the MIL-STD-130 UID Application Standard. For more information, see [Grading Standards](#).

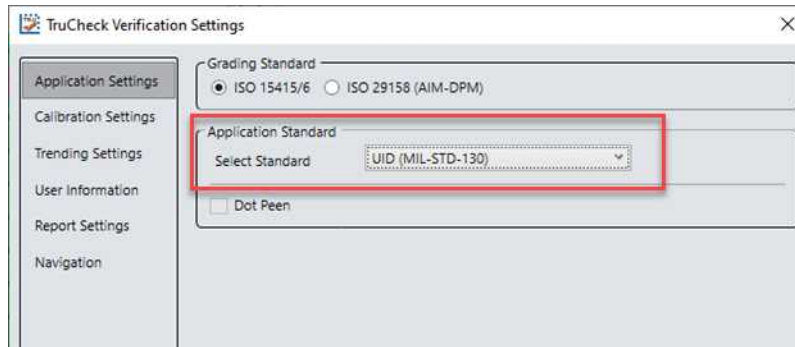

Select **Dot Peen**, if applicable.

UDI (GS1 or HIBCC)

The UDI (GS1 or HIBCC) application standard checks symbols that meet UDI requirements for medical devices using either GS1 or HIBCC guidelines.

Specify the ISO/IEC 15415 grading or the ISO/IEC 29158 grading. For more information, see [Grading Standards](#).

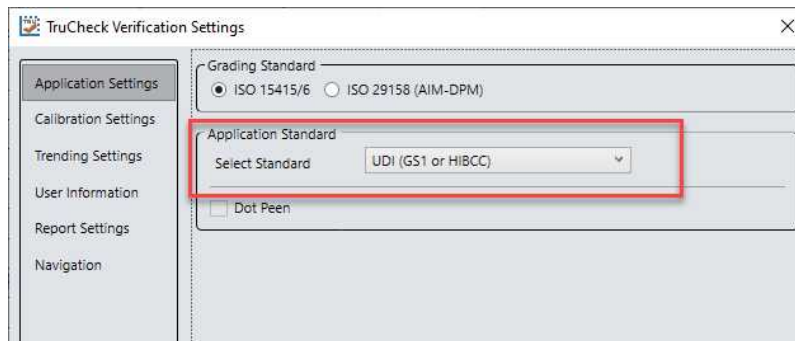

Note: UDI compliance requires data content that varies depending on the medical device the data is applicable to, so the DM475V only validates the format, not the content. Validating format is automatic and in accordance with formatting rules of the chosen grading standard guidelines.

Select **Dot Peen**, if applicable.

Auto

Apply the **Auto** application standard option to allow the verifier to select the correct application standard based on the format of the data encoded in the symbology. If the verifier detects GS1, HIBCC, or MIL-STD 130 standards within a symbology during verification, the verifier uses the correct application standard, respectively.

Note: Select the **Custom** application standard instead of **Auto** if the symbology contains data structure that the grading of the automatic standards do not apply.

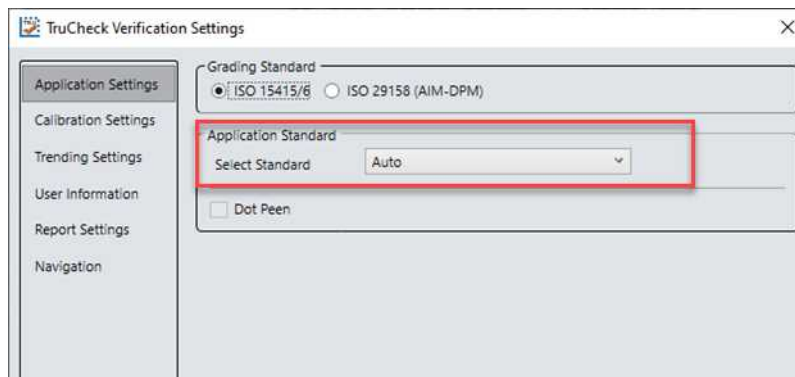

Cryptocode

The **Cryptocode** application standard checks symbols that meet Russian Cryptocode standard or other Cryptocode applications.

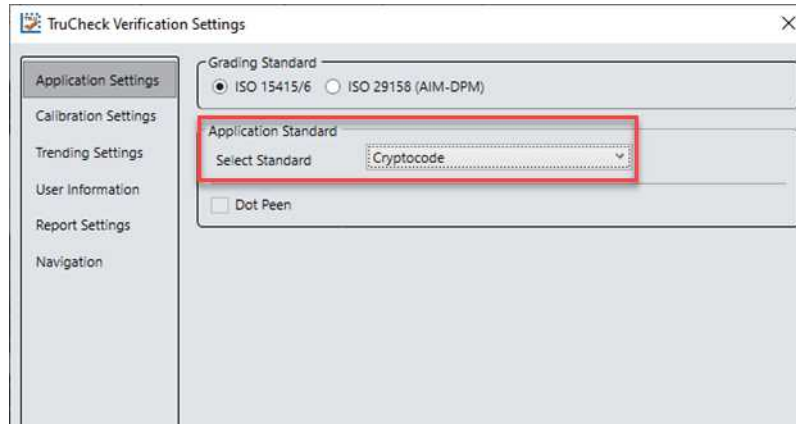

Custom

Apply the **Custom** standard option when you are grading a code that is not expected to adhere to any pre-defined industry conformance standard, and so it can be customized with specific settings for:

- Grading Standard: ISO/IEC 15415 or ISO/IEC 29158, for more information, see [Grading Standards](#).
- Minimum and Maximum X-dimension
- Overall Pass Grade
- Data Format Check
- Aperture Size

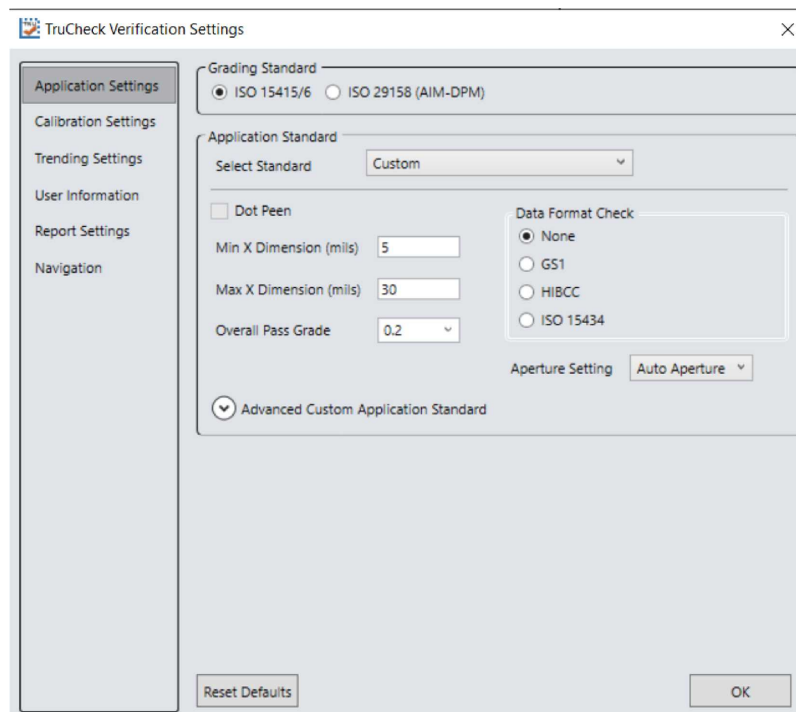

The **Custom** application setting options include **Advanced Custom Application Standard** option for the customization of grading by each individual quality parameter. The **Advanced Custom Application Standard** options allow you to select

individual pass thresholds for each Quality Parameter for 1D and 2D symbologies. If a pass grade is selected for any of the *Quality Parameters*, the *Overall Pass Grade*, which is the Acceptance Criteria evaluation of Pass or Fail, is overridden for that parameter.

Note: For example, if you set the *Overall Pass Grade* to 1.5 and the *Grid Non-Uniformity* value individually to 3.5, a symbol graded with a GNU value below 3.5 is given an Acceptance Criteria of Fail (Quality) even if the *Overall Grade* is greater than 1.5. If you set all *Advanced Custom* options to N/A, the verification does not apply any *Advanced Custom* application standard settings and evaluates the *Quality Parameters* according to the value in the *Overall Pass Grade* only.

Utilize the **Advanced Custom Application Standard** settings only in specific cases by users with a strong understanding of their application. Changing the Advanced Custom Application Standards will directly impact the Overall Grade during verification.

In addition, the **Advanced Custom Application Standard** menu provides options to choose between ISO/IEC 18004 Quiet Zone (QZ) Requirement of a 4-module quiet zone or the ISO/IEC 16480 QZ Requirement of a 1-module quiet zone.

Advanced Custom Application Standard gives users the option to select between the ISO/IEC 29158:2011 standard or the ISO/IEC 29158:2020 standard. See [DPM Standard Updates](#) to learn more about the differences between the 2011 and 2020 versions.

At the bottom of the menu, a button is provided to Clear Advanced Parameters and reset all values back to N/A.

The screenshot displays the 'TruCheck Verification Settings' dialog box, with the 'Advanced Custom Application Standard' section active. The settings are organized into two columns: '1D Pass Thresholds' and '2D Pass Thresholds'. Each parameter is represented by a dropdown menu, most of which are currently set to 'N/A'. The '1D Pass Thresholds' include Edge, Minimum Reflectance, Symbol Contrast, Minimum Edge Contrast, Modulation, Defect, Decode, Decodability, Quiet Zone, Unused Error Correction, Bar Width Growth (%), and Inspection Zone Height (mils). The '2D Pass Thresholds' include Unused Error Correction, Symbol Contrast/Cell Contrast, Modulation/Cell Modulation, Reflectance Margin, Axial Nonuniformity, Grid Nonuniformity, Fixed Pattern Damage, Average Grade/Distributed Damage Grade, Minimum Reflectance, Matrix Size (N/A x N/A), Bar Width Growth (%), and Contrast Uniformity. At the bottom, the 'QR Quiet Zone' section has two radio button options: 'ISO 18004 QZ Requirement (4)' (which is selected) and 'ISO 16480 QZ Requirement (1)'. A 'Reset Defaults' button is positioned at the bottom left, and an 'OK' button is at the bottom right.

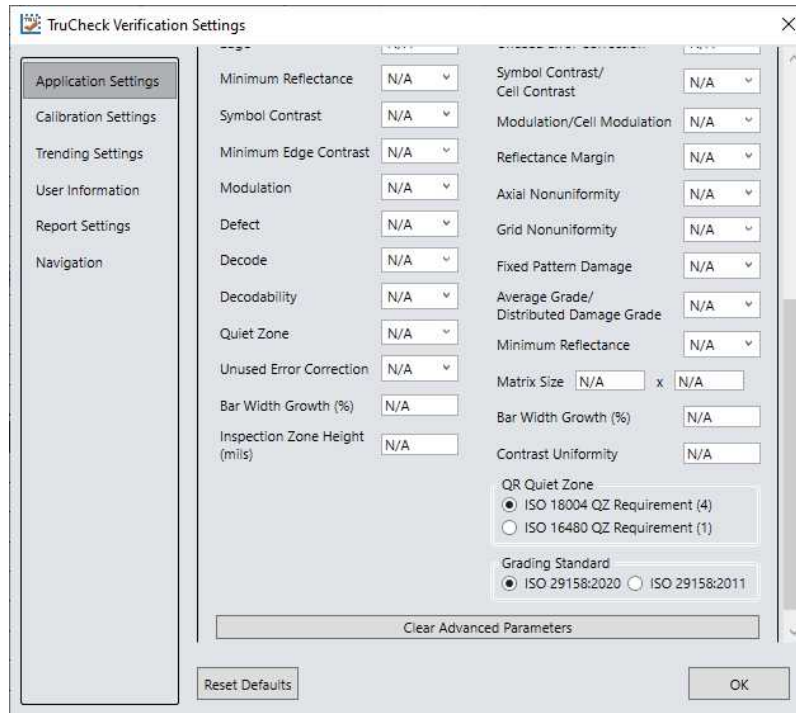

Data Format Check

You can apply a specific **Data Format Check** criteria to the data content of the code or leave the option as **None**. If you apply a specific Data Format Check, a **Data Format Check** grading box becomes available on the main screen of the User Interface to show the Pass or Fail grade. The report contains a Data Format Check table showing detailed parsing information.

- **GS1**: The GS1 option checks the format of the data against GS1 formatting rules. GS1 codes generally begin with a Function 1 <F1> character.
- **HIBCC**: The HIBCC option checks the format of the data against HIBCC formatting rules. HIBCC codes generally begin with a + character.
- **ISO/IEC 15434**: The ISO 15434 option checks data for many industry standards which encode information using ISO/IEC 15434 data structures. ISO/IEC 15434 codes generally begin with the sequence `]]><RS>nn<GS>` where `nn` are two digits which are typically 05, 06 or 12. MIL-STD-130 and some shipping container applications use this formatting style.

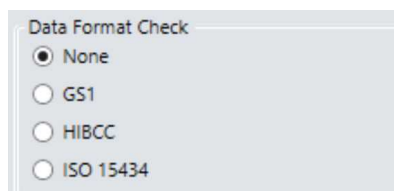

Aperture Setting

Aperture setting refers to a synthetic aperture as opposed to an optical aperture. Aperture is a circular region imposed on the pixels which comprise the individual modules making up the code. This process is mandated by the ISO/IEC 15415 and 15416 standards. Set the aperture settings when choosing Generic Application Standards.

Aperture Size setting is compatible with ISO/IEC 15415 only. AIM-DPM grading includes a blurred reference image, similar to ISO/IEC 15415. The AIM-DPM grading method dictates the aperture size to be either 50% or 80% of the symbol X-dimension.

Note: Aperture setting must match the Application Standard.

Larger aperture sizes reduce:

- Sensitivity to printing defects
- Ability to resolve small elements in a code

The size of the aperture is limited by the X-dimension of your symbols, or the X-dimension of your symbols is limited by the size of your aperture. Choose aperture size in application specification, quality specification or both. If you do not know the correct aperture size to select, choose **Auto** and the verifier uses guidelines in ISO/IEC 15415 to choose an aperture size based on the X-dimension of the code.

Always specify an aperture size for the Generic Application Standard when using ISO/IEC 15415 Grading Standard.

In the drop down menu, select:

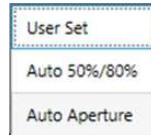

User Set

The application allows you to specify the **Aperture Setting**. If you select **User Set**, an additional drop down menu shows up for you to select the aperture.

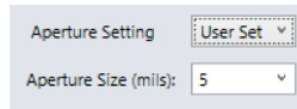

Auto 50% or 80%

The application automatically sets an aperture size based on 50% of the X-dimension for 1D symbologies and 80% of the X-dimension for 2D symbologies.

Auto Aperture

This chapter describes available automatic aperture settings.

Auto Aperture for 1D Barcodes

The application automatically sets an aperture size based on the X-dimension in accordance with the suggestion in ISO/IEC 15416. For the Generic Application Standard, the following table applies for most symbologies:

X-Dimension	Aperture
≤ 7.0 mil	03 (3 mil)
$7.1 \text{ mil} < x \leq 13 \text{ mil}$	05 (5 mil)
$13 \text{ mil} < x \leq 25 \text{ mil}$	10 (10 mil)
> 25 mil	20 (20 mil)
For UPC/EAN, regardless of X-dimension or magnification	06 (6 mil)

You can override these rules by determining a specific aperture directly for any application that requires a specified aperture. An application specification (such as GS1 Gen Spec, or MIL-STD 129) specifies an aperture value which can be different than what the rules in the table would yield.

Auto Aperture for 2D Barcodes

The application automatically sets an aperture size based on the X-dimension in accordance with the suggestion in ISO/IEC 15415. For the Generic Application Standard, the following table applies for most symbologies:

X-Dimension	Aperture
≤ 6 mil	02 (2 mil)
6 mil < x ≤ 7.5 mil	03 (3 mil)
7.5 mil < x ≤ 10 mil	05 (5 mil)
10 mil < x ≤ 20 mil	08 (8 mil)
20 mil < x ≤ 30 mil	16 (16 mil)
≥ 30 mil	20 (20 mil)

Note: AIM-DPM grading (ISO/IEC TR 29158) always selects an aperture automatically based on the X- Dimension of the decoded symbol, which overrides the above rules. These rules apply to ISO/IEC 15415 grading if **Auto Aperture** is selected.

Dot Peen

Use the dot peen option for codes created through a process where dots are peened onto a metal surface. Select **Dot Peen** to use the AIM-DPM Stick algorithm to connect dots.

The following options are available when you select the Custom application standard:

Note: You can select **Dot Peen** only if you select ISO/IEC 29158 (AIM-DPM) as **Grading Standard**. For more information, see [Grading Standards on page 34](#).

- Min X-Dimension (mils)
- Max X-Dimension (mils)
- Pass Grade

Min X-Dimension (mils)

Set the minimum x-dimension value. It is not possible to set the value lower than 0.1 mil. Any code that falls below the minimum x-dimension receives a grade of Fail (X-Dimension out of Range). If you do not specify a minimum x-dimension, the application default is 5 mils.

Max X-Dimension (mils)

Set the highest possible x-dimension value. The highest value that can be set is 130 mils. Any code that is above the maximum x-dimension receives a grade of Fail (X-Dimension out of Range). If you do not specify a maximum x-dimension, the application defaults to 30 mils.

Pass Grade

Select a minimum passing grade based on a letter and a number which is C >1.5. Any verified code that does not receive an Overall Grade above the Pass Grade minimum receives a grade of Fail for Pass Grade on the User Interface and in the Report.

Pass Grade

C (>1.5) ▾

Grading Standards

For more information, visit support.cognex.com, and navigate to Resources > Introduction to Barcode Verification.

Calibration Settings

The **Calibration Settings** menu can enable a reminder for calibration as well as set the number of days that have elapsed since the previous calibration for the reminder.

The verifier must be calibrated for ISO/IEC conformance.

When the verifier is used in an uncalibrated state, neither the aperture nor Symbol Contrast (SC) for ISO/IEC 15415/15416 applications and Minimum Reflectance (MR) for ISO/IEC TR29158 (AIM-DPM) applications are reported.

Note: If you use the verifier in an uncalibrated state, the default aperture selection is Auto 80% but no aperture value is reported.

In addition, there is a button to **Discard Calibration** and return the verifier to an uncalibrated state. Discarding the calibration can have some benefits. For example, if the ink and paper combination is not black and white, the software can reference the brighter and darker reflectance values of the codes, not just the extreme bright and dark values. Applications like UV greatly benefit from this feature.

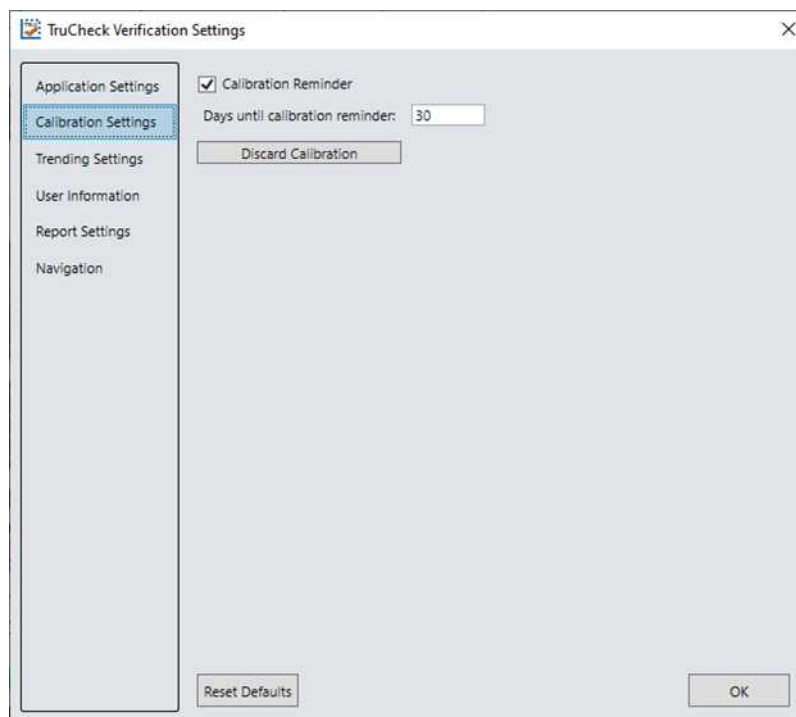

Trending Settings

The **Trending Settings** menu allows users to set the threshold that determines if the trending is evaluated as Pass or Fail. With the option to set the values for X and Y, you can establish an overall verification failure when X out of the last Y verifications fail the current application standard.

For example, if you set X to 3 and Y to 10, a message will show above the trending graph stating "Overall Verification Failure: 0 out of the last 0 verifications failed the current application standard. Threshold is 3/10" whenever 3 or more of the last 10 verifications resulted in a failing Overall Grade.

The main screen in the TruCheck Window shows the trends. See [User Interface on page 14](#).

The screenshot shows the 'TruCheck Verification Settings' dialog box. On the left is a vertical navigation menu with the following items: Application Settings, Calibration Settings, Trending Settings (highlighted with a blue border), User Information, Report Settings, and Navigation. The main area of the dialog is titled 'Trending Settings' and contains the following elements:

- A checked checkbox labeled 'Trending'.
- A text description: 'Overall verification failure when X out of the last Y verifications fail the current application standard.'
- A label 'X number of verifications:' followed by a text input field containing the number '1'.
- A label 'Y number of verifications:' followed by a text input field containing the number '1'.
- At the bottom left, a 'Reset Defaults' button.
- At the bottom right, an 'OK' button.

User Information

The **User Information** menu provides fields for the user to include the **Company Name**, **Operator Name**, and **Batch Number** that are then added to the header of the report. Selecting the **Auto Batch** checkbox allows any batch number that is detected in the barcode to be added to the report. For example, if a GS1 DataMatrix symbol is verified that includes the Application Identifier for batch number, the batch number included is reported. **Custom Note** allows you to add a wide variety of information to the report.

The screenshot shows the 'TruCheck Verification Settings' dialog box with the 'User Information' menu item selected in the left navigation pane. The main area of the dialog is titled 'User Information' and contains the following elements:

- A text input field for 'Company Name'.
- A text input field for 'Operator Name'.
- A text input field for 'Batch Number'.
- An unchecked checkbox labeled 'Auto Batch'.
- A text input field for 'Custom Note'.
- At the bottom left, a 'Reset Defaults' button.
- At the bottom right, an 'OK' button.

Report Settings

The **Report Settings** menu allows you to select the unit of measurement for reporting values.

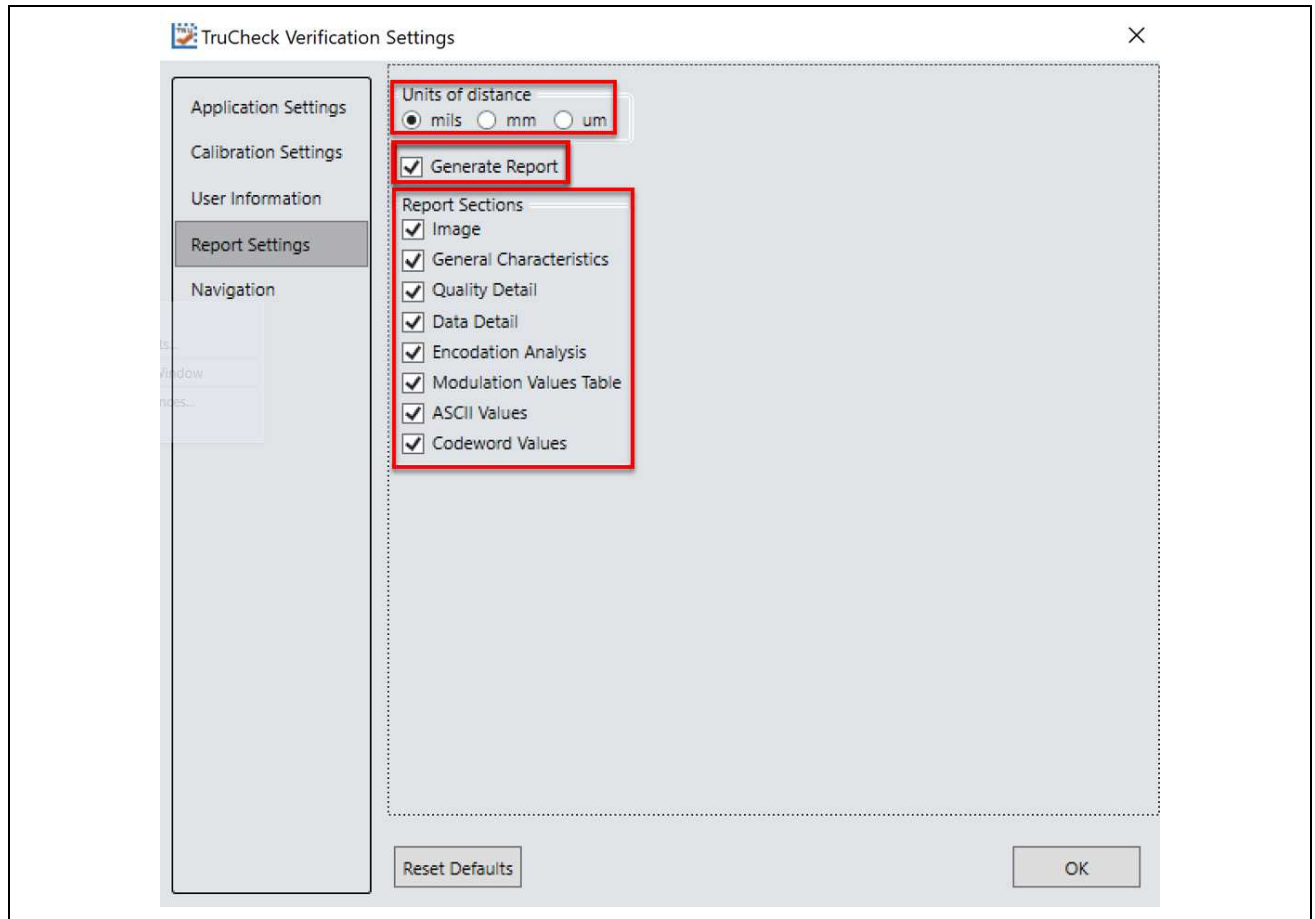

Element	Description
Units of distance	Select a unit of measurement for reporting X-Dimension. You can choose: <ul style="list-style-type: none"> • mils (thousandths of an inch) • mm (millimeters) • μm (micrometers)
Generate Report	Check the Generate Report checkbox to allow generating reports.
Report Sections	Each checkbox under Report Sections controls whether a particular section is included in the report. If you uncheck a checkbox, the report becomes smaller.

Navigation

The **Navigation** menu allows you to access certain options in the Setup Tool window to configure exporting results either through Setup Tool or FTP. The Navigation menu also provides a shortcut to enable or disable symbologies and to set up the verifier to verify multiple symbols in one verification. Click the View button to re-direct to the settings of each reporting option in Setup Tool.

Note: Maximize Setup Tool for the shortcuts to work. For more information on Setup Tool Panes, see the *Setup Tool Reference Manual*.

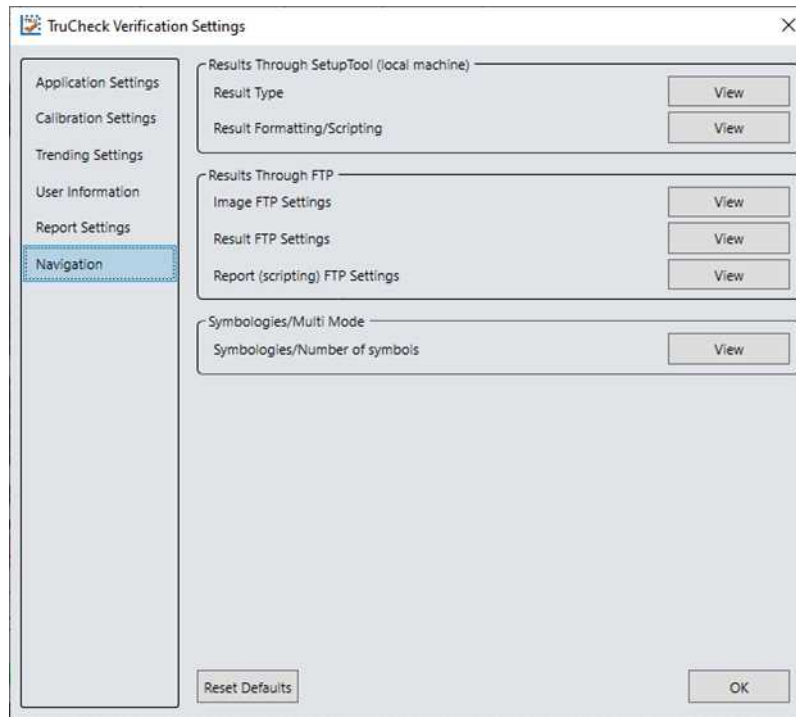

Results through Setup Tool (local machine)

In the **Results through Setup Tool (local machine)** section, two options are available to navigate to the Setup Tool windows to set up a scripting menu for exporting verification results either as an HTML or CSV report:

- Result Type
- Result Formatting/Scripting

For more information on the scripting options available for verification, see [Scripting on page 41](#). For more information on broad scripting options available in Setup Tool, refer to the **Scripting** section of the *DataMan Communications & Programming Guide*.

Result Type

Click **Result Type** to open the **Basic** tab in the **Format Data** application step in Setup Tool. Select **Script-Based Formatting** to enable scripting for export of verification data to CSV or to custom, script-defined format.

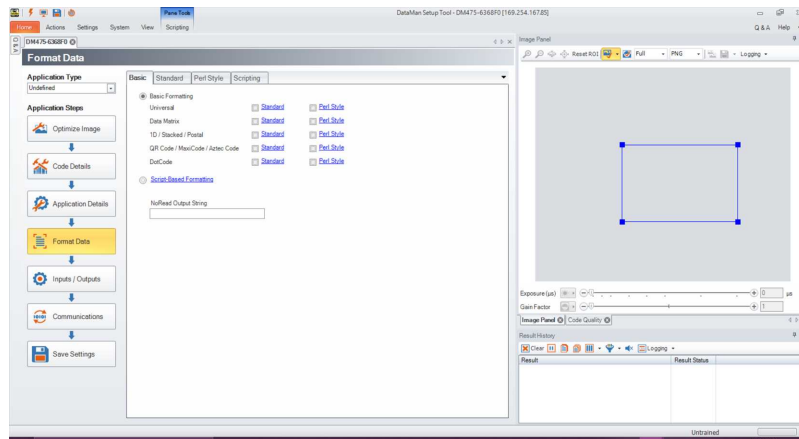

Result Formatting/Scripting

Click **Result Formatting/Scripting** to open the **Scripting** tab in the **Format Data** application step in Setup Tool. Create a script for outputting results or load a pre-written snippet in this window.

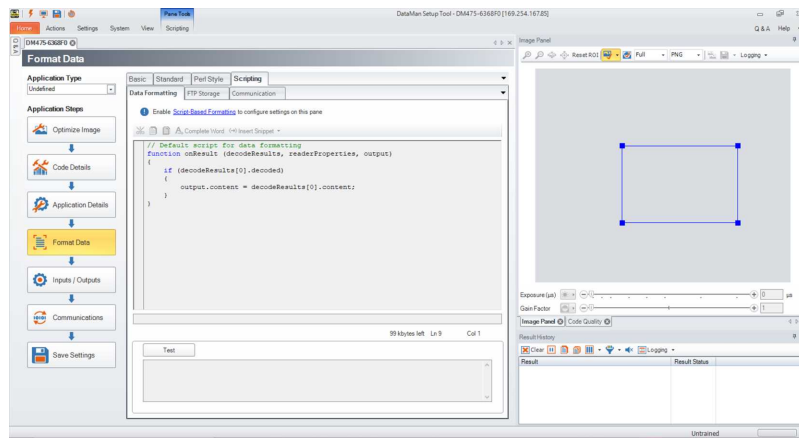

Results through FTP

In the **Results through FTP** section, three options are available to navigate to windows in the Setup Tool that connect to an FTP server for exporting verification:

- Image FTP Settings
- Result FTP Settings
- Report (scripting) FTP Settings

For more information, see [Setting Up FTP Transfer on page 42](#).

Image FTP Settings

Click **Image FTP Settings** to open the **Image Transfer** tab in the **Format Data** application step in Setup Tool. Enter information in this window to set up image export via FTP transfer.

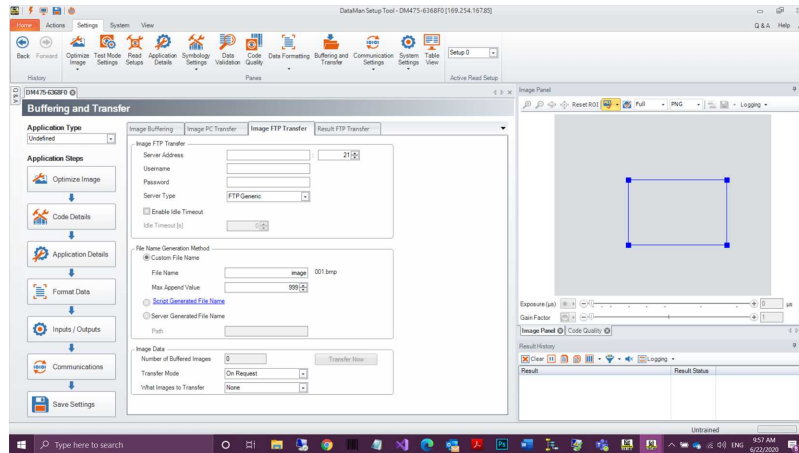

Result FTP Settings

Click **Result FTP Settings** to open the **Result FTP Transfer** tab in the **Format Data** pane in Setup Tool. Enter information in this window to export verification results via FTP transfer.

Note: Minimize TruCheck window and click Setup Tool window on the taskbar.

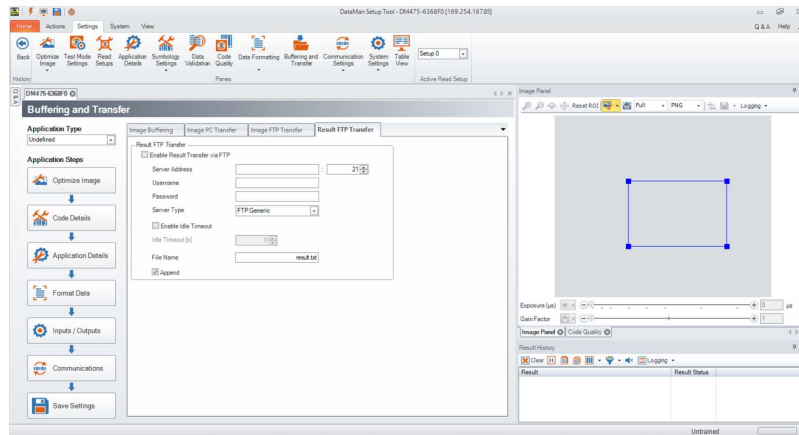

Report (scripting) FTP Settings

Click **Report FTP Settings** to open the **Report FTP Transfer** tab in the **Code Quality** application step in Setup Tool. Enter information in this window to export verification results via FTP Transfer.

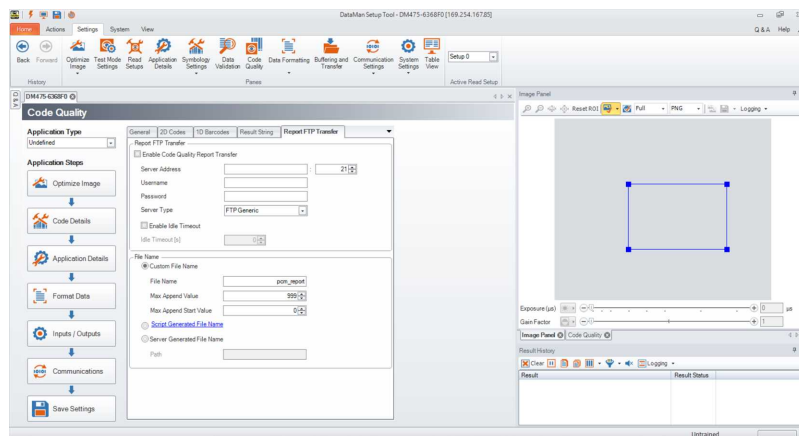

2. Select the **Scripting** tab on the ribbon menu.

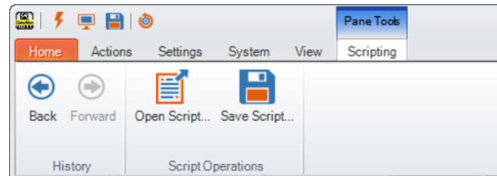

3. In the **Scripting** pane on the ribbon, click **Open Script**.
4. Navigate to the location of the Scripting templates: C:\Program Files (x86)\Cognex\DataMan\DataMan Software vx.x.x\Scripts. One scripting template generates results to a .CSV file and the other generates results to an .HTML file.
5. To save the output to a file, click the **Results History** window on the right.
6. In the **Logging** option, check the box to **Log all result codes to file system** and select the option for **Logging and reporting settings....**

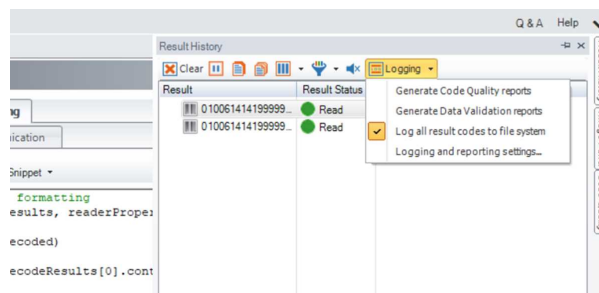

7. In the **Logging and reporting settings** menu, enter a file **Path** and **File Name** under the **Result Code** section. After providing a **File Name**, you must include either .CSV or .HTML depending on which template is selected.
8. Select **OK** to save and exit.

Note: If you do not include .CSV or .HTML after the file name, Setup Tool will not save the report correctly.

Result Code	
Path	C:\
File Name	sample report.html

You can customize the scripts to show more or less detail. For the full list of scripting options, see the **DataMan Communications and Programming Guide**.

Setting Up FTP Transfer

To configure the Dataman 475V to export verification results through FTP, change settings in Setup Tool to communicate with an external FTP server. Setup Tool can export information about:

- The image used for verification
- The result information provided from the **Result History** pane in Setup Tool
- The verification results provided in the **Code Quality** report.

To begin setting up an FTP server, configure an FTP server to communicate with Setup Tool. To set up the necessary information in the Setup Tool window, choose from three panes available for FTP transfer depending on what you would like to transfer:

- Image FTP Transfer
- Result FTP Transfer
- Report (scripting) FTP Transfer

The TruCheck window provides shortcuts to the three Setup Tool panes *Settings>Navigation>Results through FTP* menu. For more information, see [Results through FTP on page 39](#).

You can also click **Settings** in Setup Tool on the ribbon menu and open **Buffering and Transfer** to access the FTP settings.

Image FTP Transfer

To set up image transfer via FTP, fill in the **Server Address**, the **Username**, and the **Password** (if applicable) fields depending on the setup of your FTP server settings.

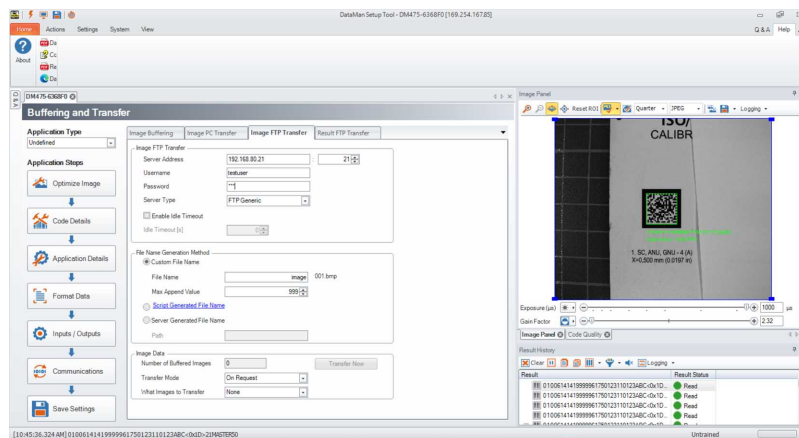

Result FTP Transfer

To set up result transfer via FTP, fill in the **Server Address**, the **Username**, and, if the software prompts you, the **Password** fields, depending on the setup of your FTP server. Selecting this option exports the results available in the **Result History** pane of Setup Tool for exporting to the FTP server. After all required fields are filled in, select the box next to **Enable Result Transfer via FTP**. Use the FTP Transfer setting when exporting verification results using scripting. In case of using one of the included CSV script snippets, include the .csv file extension at the end of the **File Name** field, for example *VerificationResults.csv*.

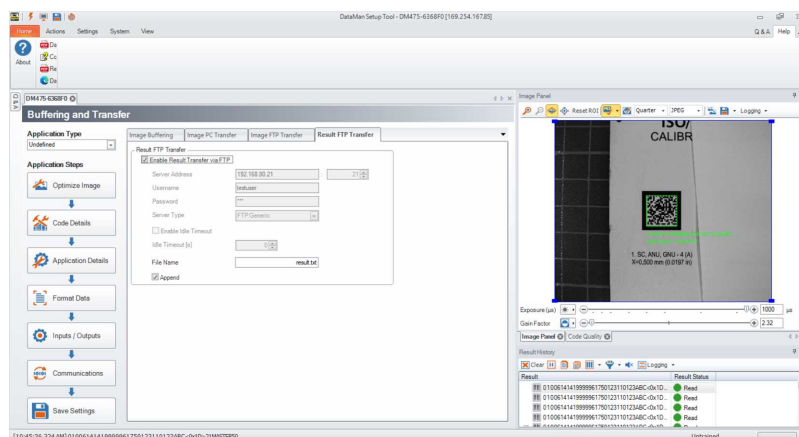

Saving Reports

You can see a preview of the report in the **Report** tab. See [Report Tab on page 59](#).

Check the **Generate Report** box in the **Report Settings** menu.



You can save and print the report by right-clicking on the report. Select a printer or **Save to PDF**.

Alternatively, you can save and print electronic reports by enabling the Code Quality report in the DataMan Setup Tool window:

1. Open the DataMan Setup Tool, and navigate to the **Results History** pane.
2. In the **Logging** drop-down menu, click on the **Generate Code Quality reports**.

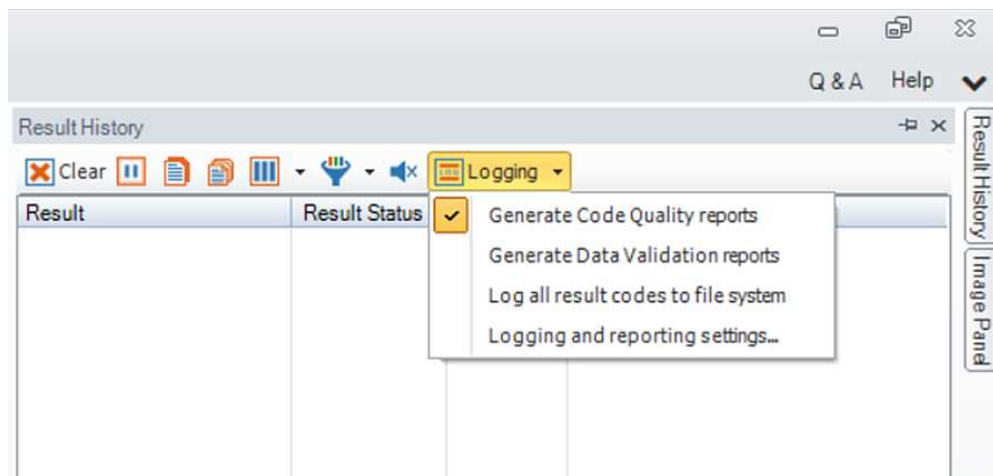

3. In the same drop-down menu for **Logging**, select **Logging and Reporting Settings** to open the **DataMan Setup Tool Options** window.

4. In the **Reporting** box, select the **Path** to save verification reports to your local computer or server. Include a **Filename Prefix** or **Filename Structure** and select the **Preferred Quality Report File Extension** as either *.html* or *.pdf* file.

For the **Filename Prefix**, you can enter a custom string, or use a predefined string variable that the system automatically translates based on your settings. The following predefined strings are available:

- {Grade}
- {GradeLetter}
- {GradeNumber}
- {Symbology}
- {Data}
- {Batch}
- {UII}
- {Company}
- {Operator}
- {Note}

Note: The strings are case sensitive and must include the curly braces.

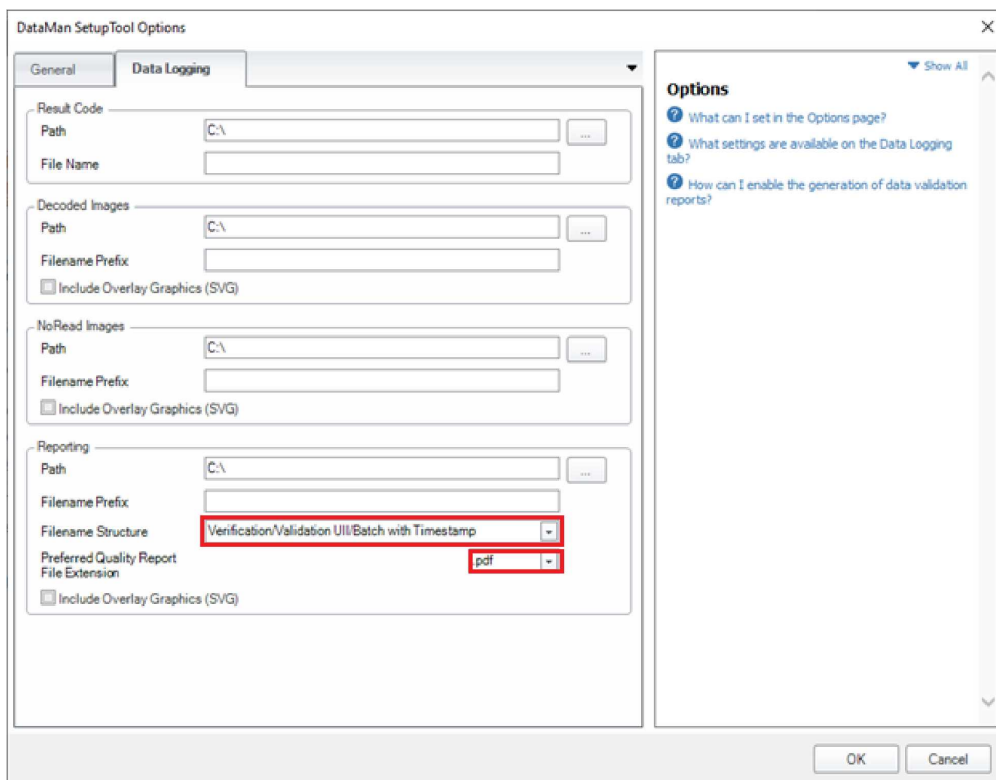

Note: The TruCheck Window only displays a report preview if you check the **Generate Report** checkbox under [Report Settings on page 37](#).

Set Date and Time

To place a time stamp on verification reports:

1. Connect your verifier in the DataMan Setup Tool.
2. Select **Settings**.

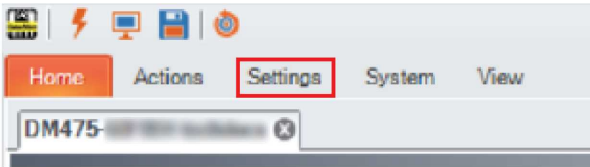

3. Select **System Settings**.

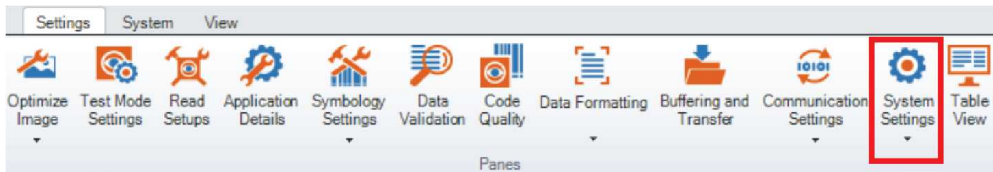

4. Select **Device Time Settings** from the dropdown menu.

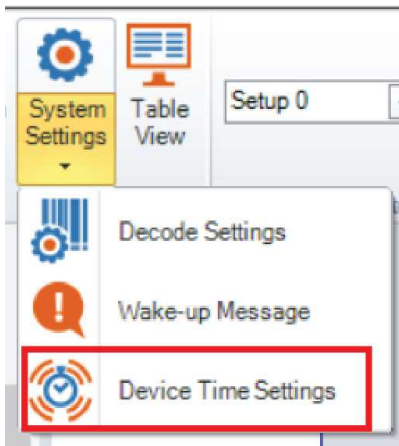

5. Choose your time zone from the dropdown menu and check **Enable NTP**.

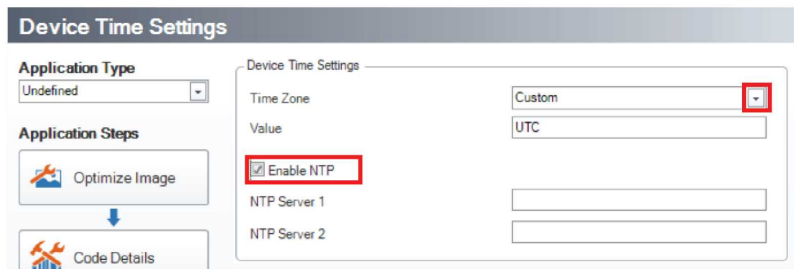

6. Enter an IP address for an NTP Time Server. An IP address can be found by searching the internet for NTP Time servers.

Note: If the computer is not connected to the internet, you must connect it to a local time server on an internal network.

7. Select **Save Settings**.



Using Your DataMan 475 Verifier

Verifying a 1D Barcode

To verify a 1D barcode in the TruCheck Verification Window:

1. Navigate to the **Main** tab.
2. Click **Go Live** and center your symbol in the field of view. Alternatively, press and release the trigger button or press **Ctrl+T** to **Go Live**. After selecting **Go Live**, the button changes to **Verify**.
3. Position the red target in the display over the center of the code.
4. Draw a selection region over the code, making sure that the region stays within the boundaries of the code. If the region extends outside the area of the code, the verifier attempts to scan the empty part of the region, resulting in un-decoded scans.

Note:

- If you enable **Linear Auto Detect** in the 1D Settings menu, the selection region can extend beyond the boundaries of the code without affecting the grade. If you do not define a region, the verifier defaults to using Linear Auto Detect for linear bar codes, regardless of whether you have enabled the setting or not.
- For linear symbols, the verifier examines areas outside the selection region in order to properly find and grade quiet zones. The region does not limit the verification to ignore areas outside the code, which can otherwise lead to wrong or misleading grade results.

5. Click **Verify Code**.

Verifying a 2D Barcode

To verify a 2D barcode in the TruCheck Verification Window:

1. Navigate to the **Main** tab.
2. Click **Go Live** and center your symbol in the field of view. Alternatively, press and release the trigger button or press **Ctrl+T** to **Go Live**.

Note: After selecting **Go Live**, the button changes to **Verify**.

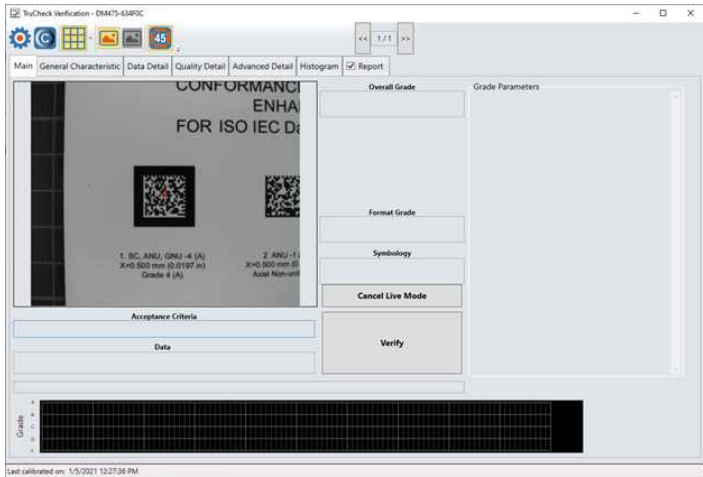

3. Draw a selection region around the code to be verified, if necessary.

Note: Make sure to draw the region around the outside perimeter of the code including quiet zones. More information on properly defining regions is explained in [Selecting Regions on page 50](#).

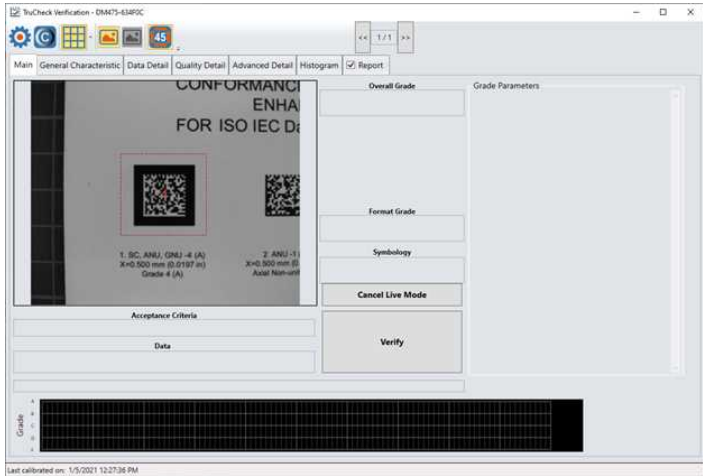

4. Click **Verify**, or press and release the trigger button or **Ctrl+T** on the verifier to begin verification.

Note: The following screenshot shows a successful 2D barcode verification. Additional details in the TruCheck window are displayed depending on grading and application standards.

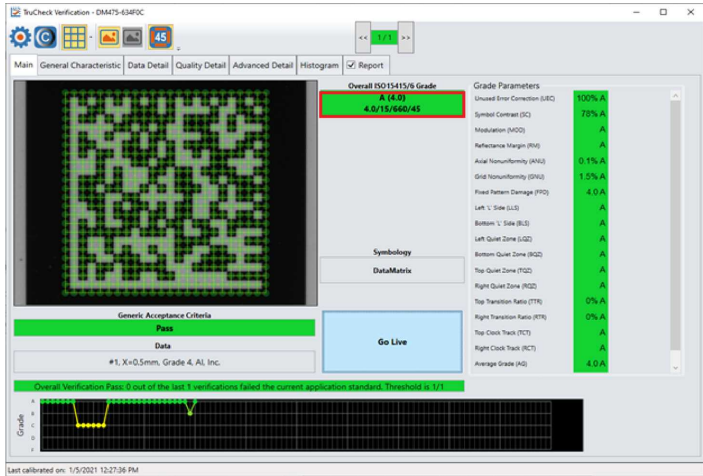

Note: Use the tool bar buttons and tabs on the screen for in-depth analysis of codes. For more information, see [Examining the Results on page 52](#).

Selecting Regions

Requirements for specifying regions on the image are the following:

- Specify a small sampling area, to speed up the verification process on verifiers with large fields of view,
- Restrict a region for image brightness adjustments when grading according to AIM-DPM (ISO/IEC 29158)
- Specify a barcode for verification when more than one barcode is present in the field of view

If you do not specify a region, the whole image is used for verification.

To specify a region, use the cursor to drag and drop.

For Data Matrix symbols and QR Codes, specify the region around the outside perimeter including quiet zones of the code to capture the entire finder pattern within the selection to properly grade the code.

When verifying a 1D symbol, select a region that includes the full width of the barcode including both quiet zones. To deselect a region, right-click in the **Live View** window.

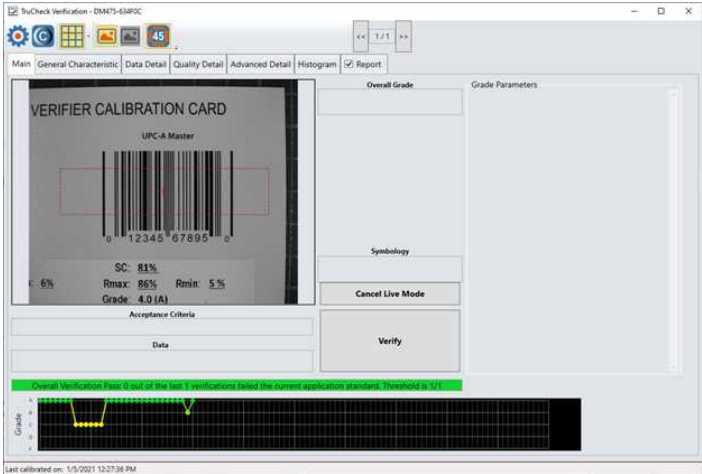

Examining the Results

This section details how to view and analyze the verification results.

1D & 2D Verification

The following chapters discuss the user interface of the TruCheck Verification. The image displays the TruCheck Verification window.

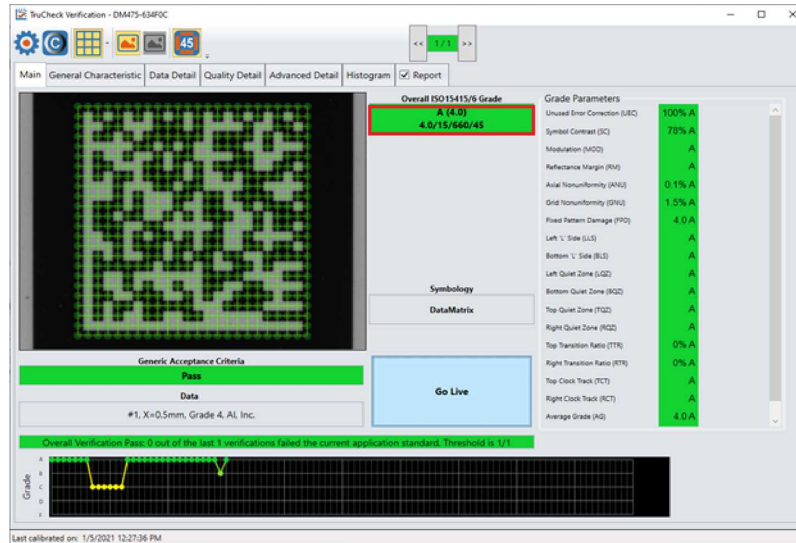

Main Tab

The **Main** tab shows a snapshot of the verification results.

Acceptance Criteria: Provides a Pass or Fail grade for the barcode and is dependent on the **Application Standard** selected. For more information, see [Application Settings on page 24](#).

Data: Shows the decoded data.

Overall Grade: Shows the overall grade results for the barcode as both a letter grade (A) and numeric grade (4.0). A Formal Grade is provided in the format “Grade/Aperture/Wavelength/Lighting”.

For example, a Formal Grade of “4.0/08/660/45” is interpreted as receiving a grade of 4.0 using 8 mil aperture (0.2 mm), 660 nm wavelength, and 45° lighting.

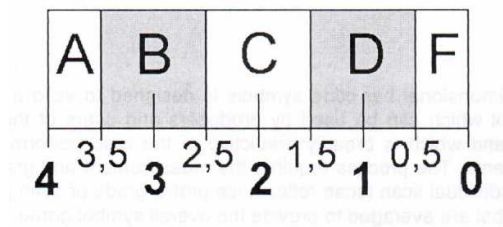

Format Grade: Indicates PASS or FAIL, depending on the **Application Standard** or **Data Format Check** criteria selected. For more information, see [Application Settings on page 24](#).

Symbology: The name of the type of barcode (for example, *Data Matrix* or *Code 128*).

Grade Parameters: Provides information on the Quality Parameters grading for the barcode. For more information, see [Quality Detail Tab on page 56](#).

Grade Trending:



The TruCheck window shows the grade trending values for symbol verified over time. The graph at the bottom of the **Main** window shows data points associated with the overall grade for each symbol verified. The grade trending reports the data point for each Overall Grade.

In verifications where a symbol passes all quality parameters but, for another reason, fails the acceptance criteria such as data parsing error or X-dimension range, the grade is shown as an F. For example, if a symbol receives an overall grade of A (4.0) but fails for an X-dimension out of range, grade trending marks the data point as an F.

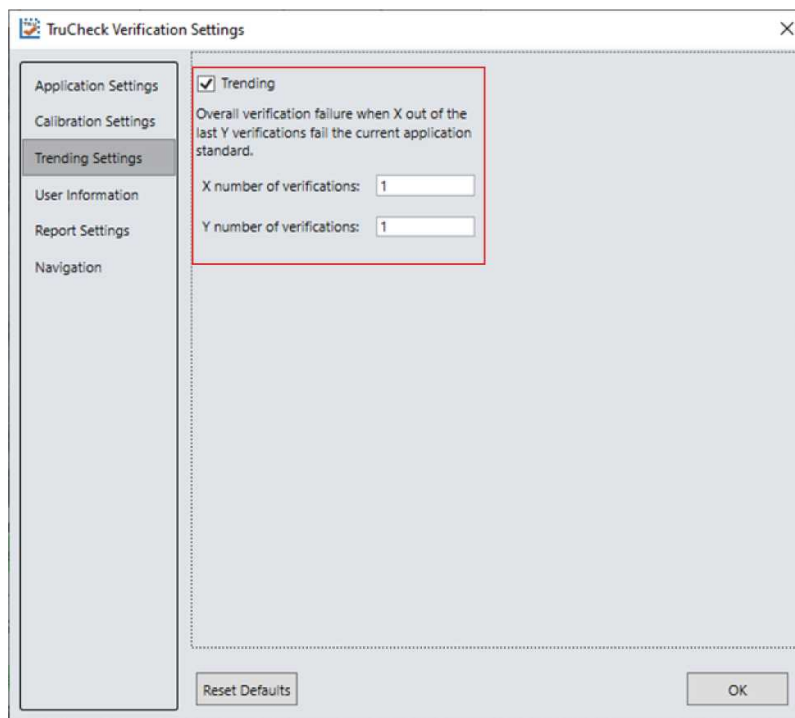

1. Enable or disable **Grade Trending** using the **Trending** checkbox in the **Trending Settings** menu.
2. Set a tolerance range for the number of verifications (X) allowed to fail out of the total number of verifications (Y) specified.

Note: If the trending point falls below the specified threshold, trending is reported as an Overall Verification Failure. The Pass Grade value set in the **Application Settings** menu determines if a symbol is a pass or fail for Grade Trending purposes. Grade Trending does not show data points for verifications that result in a NO DECODE evaluation.

Note: Grade Trending data points remain populated and continue to trend on the **Main** window until you disconnect the power from the verifier.

General Characteristics Tab

The **General Characteristic** Tab shows the physical characteristics of the verified barcode.

The image shows the characteristics of a Data Matrix barcode:

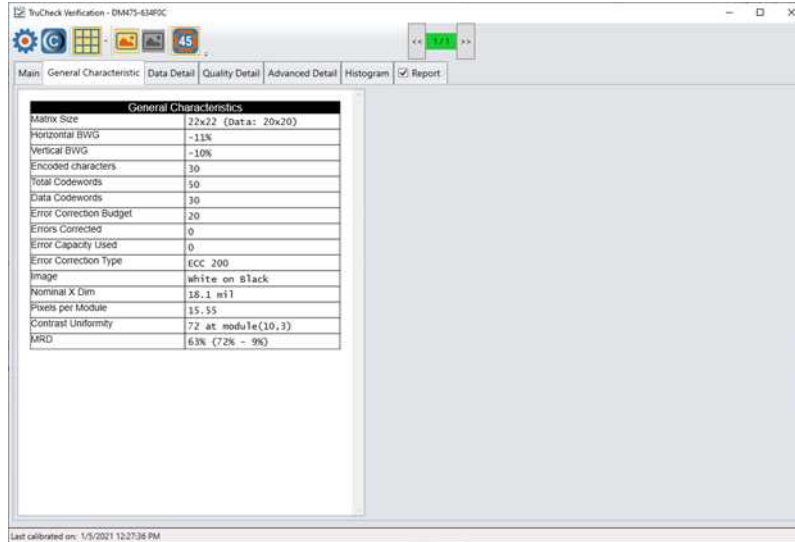

Contrast Uniformity verifies conformance with ISO/IEC 15426-2 as shown in the **General Characteristics** tab. Some of the contents of this screen depend on the symbology and settings on the **Report Settings** menu.

The image shows the characteristics of a 1D barcode:

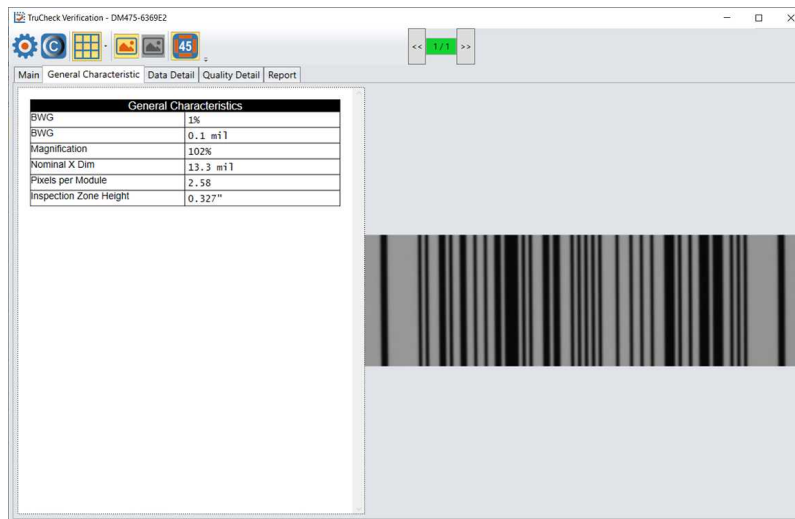

Data Detail Tab

The **Data Detail** tab shows all of the data encoded in the symbology in various ways, and makes the understanding of the symbology easier. The verbose interpretation of the symbology is especially helpful when the data is encoded incorrectly. The level of detail depends on the symbology and the selected **Application Standards**.

The image shows the encoding information of a Data Matrix and the depiction of the symbol showing each module:

The screenshot shows the 'Data Detail' tab in the TruCheck Verification software. The interface includes a menu bar with options like 'Main', 'General Characteristic', 'Data Detail', 'Quality Detail', 'Advanced Detail', 'Histogram', and 'Report'. The 'Data Detail' tab is selected, displaying a data matrix on the right and several summary tables on the left. The data matrix is a grid of numbers with a color-coded background. The summary tables include: Data (hex values), Unicode Data (Unicode characters), ASCII Values (ASCII decimal values), Codewords (raw codeword values), and Encodation Analysis (conversion of codewords to ASCII values).

The **Data Detail** tab contains the following parameters:

Data Parameter	Content
Data	Refers to the data decoded from the symbology in normal, printable characters.
Unicode Data	Shows the data interpreted as Unicode characters. The characters are the same as the characters in Data section, except when the data in the symbology encodes non-latin characters, such as Kanji, using Unicode encodation.
ASCII Values	Gives ASCII value of each decoded character. ASCII values are helpful in case an unprintable character is encoded in the symbology and you need to confirm that the character is correct. For example, by looking at the ASCII values table, you can see that a <GS> in the decoded data is actually the ASCII character with decimal value of 29, and not the four characters: “less than”, G, S, “greater than”.
Codewords if applicable	Section lists the values of the raw codewords encoded in the symbology, including the error correction codewords. An asterisk (*) denotes codewords which were decoded incorrectly and determined through error correction decoding.
Encodation Analysis if applicable	Shows the detailed conversion of raw codewords into decoded ASCII values using the encodation and compression methods defined for the symbology. For example, in Data Matrix an encodation method known as C40, the C40 method encodes 3 ASCII characters in only two codewords. Similarly, PDF417 and other 2D symbologies have various methods of encoding different types of data (such as numeric only data) in efficient ways. The encodation analysis table can show you the process of this encodation or decoding.

Modulation Table Legend

To help interpret the color coding associated with the modulation table on the Data Detail tab, the software provides a legend. The letter grade associated with each modulation value range is shown on the left. The colors are distinguished based on whether the module is light (white) or dark (black).

	Light	Dark
A 50-100	••	••
B 40-49	••	••
C 30-39	••	••
D 20-29	••	••
F 0-19	••	••

When a data checking failure occurs, a message indicates the cause of the failure.

For example, if a check digit is incorrect, a message indicates the expected check digit value. When the verification detects an error, the application stops the parsing and generates a report.

When you hover over the codewords in the Data Matrix **Codeword table**, the Code module display highlights modules constituting the 8-bit codeword are highlighted within the image to show where the data is encoded within a Data Matrix symbol.

Quality Detail Tab

The **Quality Detail** tab shows the measured quality parameters and lists the formal grade. Different symbologies and quality grading standards display pertinent data on the **Quality Detail** tab.

Characteristics of a 2D Data Matrix code graded according to ISO/IEC 15415:

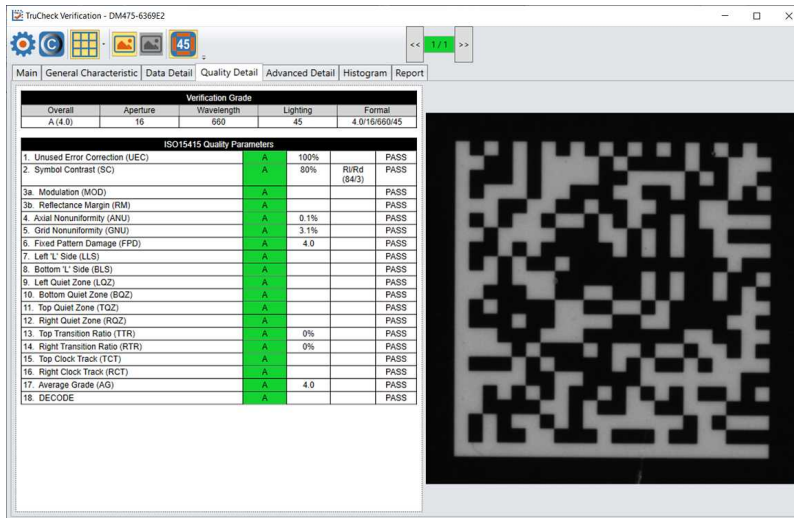

Characteristics of a 1D UPC-A symbol graded according to ISO/IEC 15416:

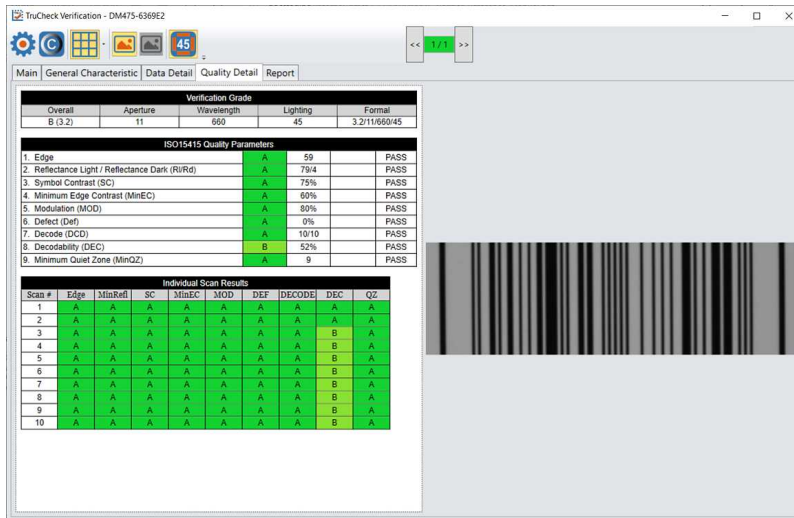

For more information on grading standards, see [Grading Standards on page 34](#).

Advanced Detail Tab

The **Advanced Detail** tab shows in-depth information on the verified code. Depending on the type of the 1D or 2D code that was verified, the information on the **Advance Detail** tab may vary.

The example shows the modulation values from the Histogram:

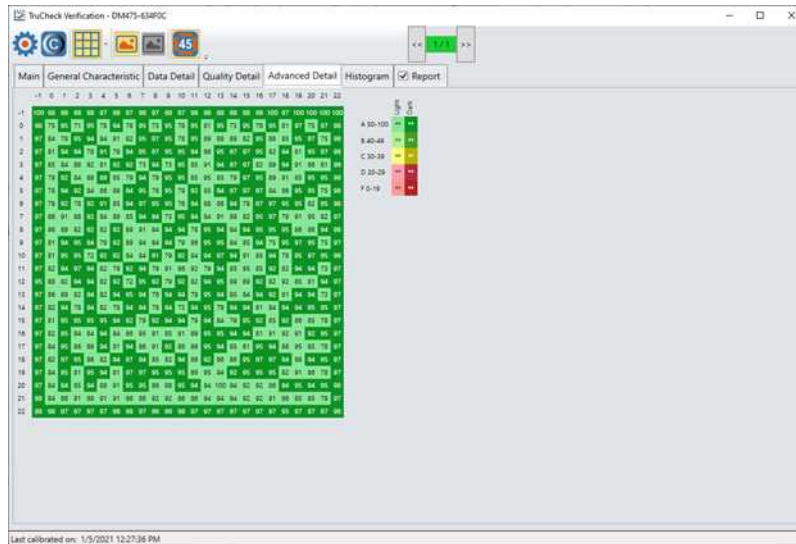

The closer a value is to 0, the closer the module lands to the global threshold.

- When a cell is marked with a 0, it means a value lands on or is on the wrong side of the global threshold and error correction had to be used.
- A dark red 0 indicates that a cell is shown as a space but it should be a module.
- A light pink 0 indicates that it should be a space but it is shown as a module.

For more information on modulation calculation, see [Grading Standards on page 34](#).

Histogram Tab

The **Histogram** tab shows the analysis of the reflectivity of each cell and associated grade.

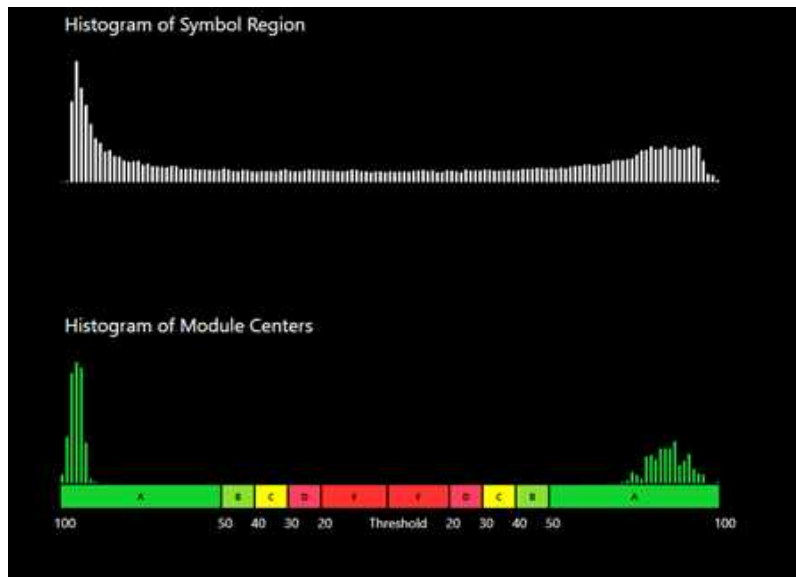

The horizontal axis on the **Histogram** represents the brightness level with the dark elements on the left side and the bright elements on the right side. As the element's brightness increases, the **Histogram** displays the element farther to the right of the **Histogram**. The height of each bar represents the number of elements with the same brightness associated with the elements' positions on the horizontal axis.

The top graph of the **Histogram** represents the brightness of all the pixels in the code region. The bottom graph of the **Histogram** represents the sampled module locations in the symbol.

The horizontal axis contains markers showing the global threshold, and all modulation levels are separated for both dark and light elements.

Note: When grading according to ISO/IEC TR29158 (AIM-DPM), the **Histogram** gets different labeling. The location of the 0% and 100% labels on the horizontal axis are at the means of the dark and light lobes of the Histogram and there is no C level because the DPM grading method uses only A, B, D and F levels for Cell Modulation.

Report Tab

Note: The Code Quality report contains the results specific to verification when the verification feature key is installed and verification is enabled in the Setup Tool window. The Code Quality report contains the results and separate from the previous Code Quality results that Process Control Metrics (PCM) generate.

When you enable the **Code Quality report**, the **Report** tab becomes available in the **TruCheck Verification** window showing full verification results formatted into a printable report.



Standards Based Grading

The Standards Based Grading option of the DM475V uses verification algorithms to produce well-defined, consistent results from the image of a code captured by a barcode reader in a real-world setup. The system utilizes Standards Based Grading if you do not use the provided Label Light attachment.

Note: Standards Based Grading is a solution to produce reliable barcode verification results in situations where ISO/IEC compliance is not required, but please note that Standards Based Grading does not provide true verification results. For ISO/IEC compliant, true verification result, use the provided Label Light attachment.

Aim for an optical setup that is as close as possible to a fully ISO/IEC compliant verifier – especially the lighting angle. The system calculates parameter values in the same way as with a verifier, so the closer the setup is to a true verifier, the closer the results are to true verification. If the lighting setup is the same, parameter values between standards based grading and verification converge. Standards Based Grading is the closest way to achieve verification results when it is not practical to conform to specific lighting angles, distances, or every ISO/IEC standard parameter.

Make sure that you calibrate the system if you want to perform Standards Based Grading. If the verifier is used without calibration, the verifier does not report all quality parameters. When you do not perform the calibration, the verifier does not report the aperture or Symbol Contrast (SC) for ISO/IEC 15415/15416 applications and Minimum Reflectance (MR) for ISO/IEC TR29158 (AIM-DPM) applications.

Note: In an uncalibrated state, the verifier does not report aperture value, but uses the default aperture selection: Auto 80% for 2D applications and Auto 50% for 1D applications.

Verifications of Multiple Symbols

To enable the multiple barcode verification feature, complete the steps in DataMan Setup Tool before initiating verification in the TruCheck window.

1. Open DataMan Setup Tool.
2. To connect to the DM475 Verifier double click on the icon in the automatically generated list on the **Start up** page.

Note: If you have trouble connecting, refer to DataMan Setup Tool Reference manual.

3. Select **Code Details** from the **Application Steps** in Setup Tool.
4. Under the **Basic** tab, change the **Number of Codes** field to a value greater than 1 to see the expanded list of options available.

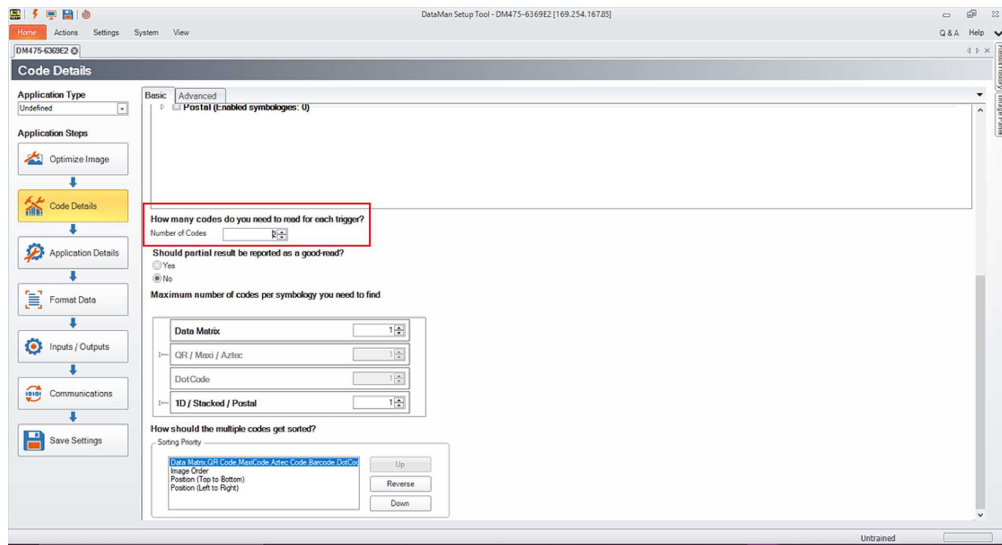

5. Select the **Number of Codes** to be verified during a single trigger.
6. For **Should partial result be reported as a good read?** select **No**.

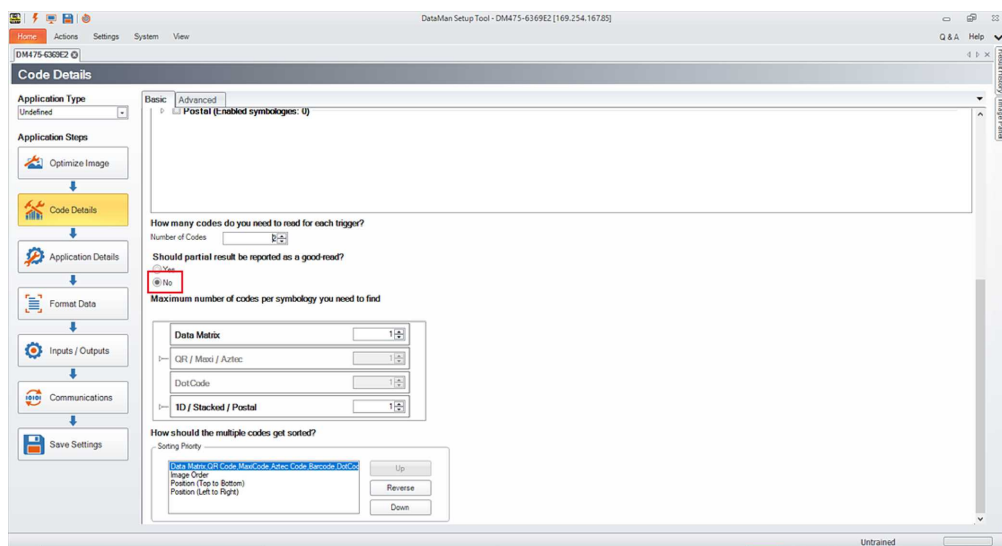

7. Select the quantity of each symbology type to be verified in a single trigger under **Maximum number of codes per symbology you need to find**.
8. Select the appropriate **Sorting Priority**.
9. Open the TruCheck window and initiate a verification.

For multiple verifications, select either a single region to identify all symbols for verification, or the entire field of view.

See the individual results in the tabs with the help of the arrows at the top of the TruCheck verification window, following the successful verification of multiple symbols. If all verifications pass, the box is green. If any verification fails, the box is red.



Saved Code Quality reports include an appended report containing individual result for each verified barcode.

Cleaning and Maintenance

Cleaning the Verifier Housing

To clean the outside of the verifier housing, use a small amount of mild detergent cleaner or isopropyl alcohol on a cleaning cloth. Do not pour the cleaner directly onto the verifier housing.



CAUTION: Do not attempt to clean any DataMan product with harsh or corrosive solvents, including lye, methyl ethyl ketone (MEK) or gasoline.

Cleaning the Verifier Lens Cover

To remove dust from the lens cover, use a pressurized air duster. The air must be free of oil, moisture or other contaminants that could remain on the lens cover. To clean the plastic window of the lens cover, use a small amount of isopropyl alcohol on a cleaning cloth. Do not scratch the plastic window. Do not pour the alcohol directly on the plastic window.

Setting Up Your DataMan 475 Verifier

This section provides information on the physical appearance of the DataMan 475 Verifier . It also details the steps of installing the lenses and filters of the verifier, and gives information on the imager.

Reader Layout

The following image shows the lighting system of the DataMan 475 Verifier Label and the mounting holes underneath the plastic lighting cover.

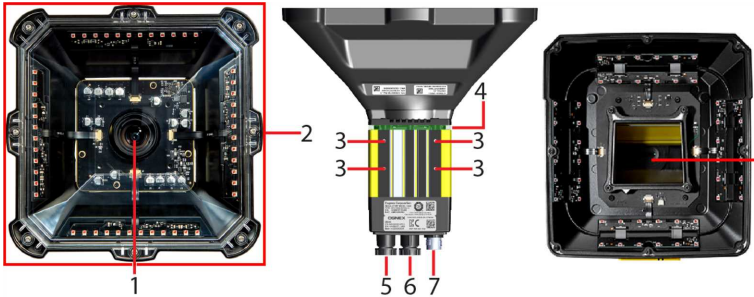

Item	Description
1	Lens
2	Label Light attachment
3	Mounting holes (M3 x 5 mm)
4	Indicator light ring
5	Ethernet connection
6	External lighting connection (disabled for verification)
7	Breakout cable connection
8	DPM Light attachment

The image shows the back cover of the DataMan 475 Verifier and the functions of the indicator lights.

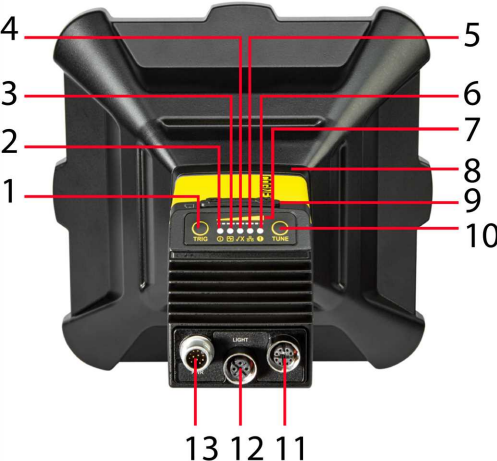

Item	Description
1	Trigger button

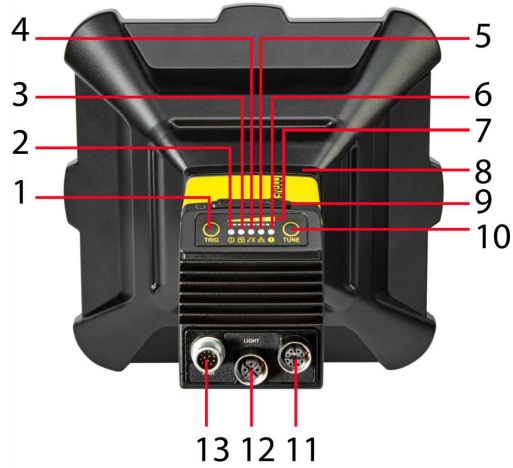

Item	Description
2	Power
3	Train status
4	Good/bad read
5	Network
6	Error
7	Peak meter
8	Indicator light ring
9	SD card slot
10	Tuning button
11	Ethernet
12	External light control
13	Power, I/O, and RS-232

The table explains the indicator light ring behavior.

Type	Signal	Color	Meaning
Status	Power	GREEN	Power ON
	Train status	GREEN	Trained
		YELLOW	Untrained
Error	RED	Error - check device log	
Action	Good/bad read	GREEN	Good read
		RED	Bad read
	Communication	YELLOW	Link up
		<i>blink</i>	Activity
Peak meter	-	Decode yield, train progress/quality	

Dimensions

Note:



- Dimensions are in millimeters [inches] and are for reference purposes only.
- All specifications are for reference purposes only and can change without notice.

Observe the following DataMan 475 Verifier dimensions when installing the verifier.

DataMan 475 Verifier Label Light

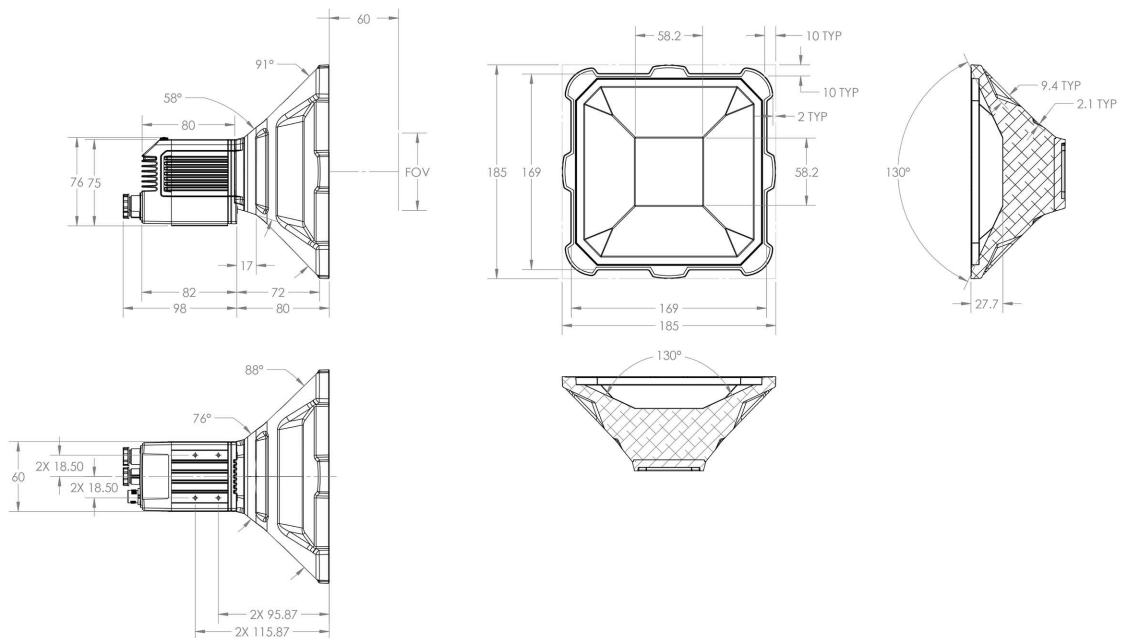

DataMan 475 Verifier DPM

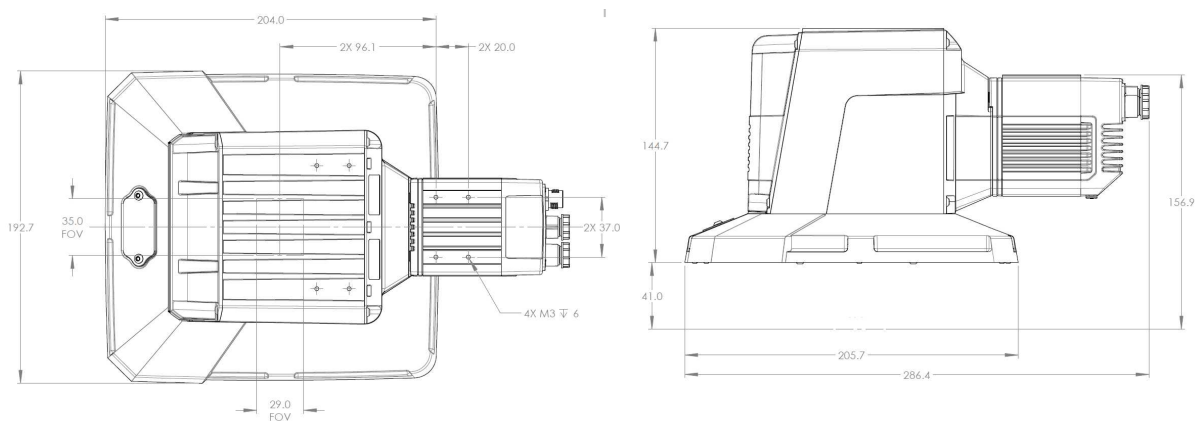

DataMan 475 Verifier HD

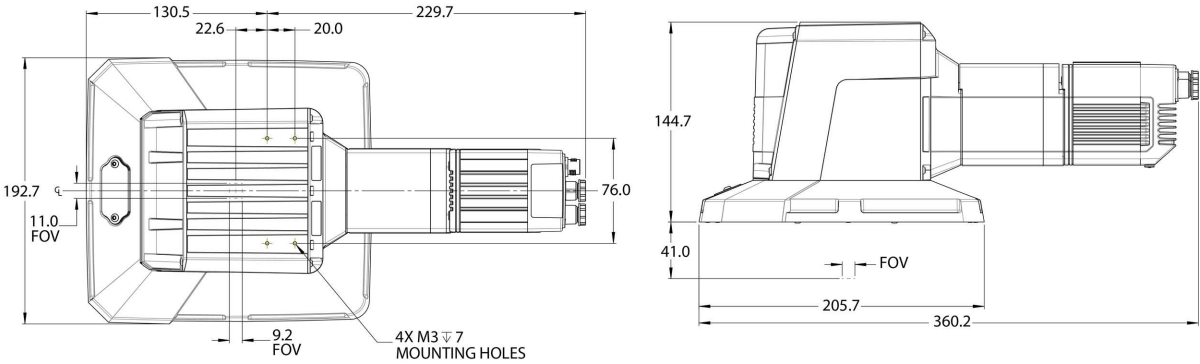

Removing Illumination Attachment

In cases where only 90° lighting is necessary or space is limited, you can remove the lighting attachment from the DataMan 475 Verifier DPM.

Perform the following steps to safely remove the illumination attachment:

1. Remove the marked screws then pull the side illumination attachment away.

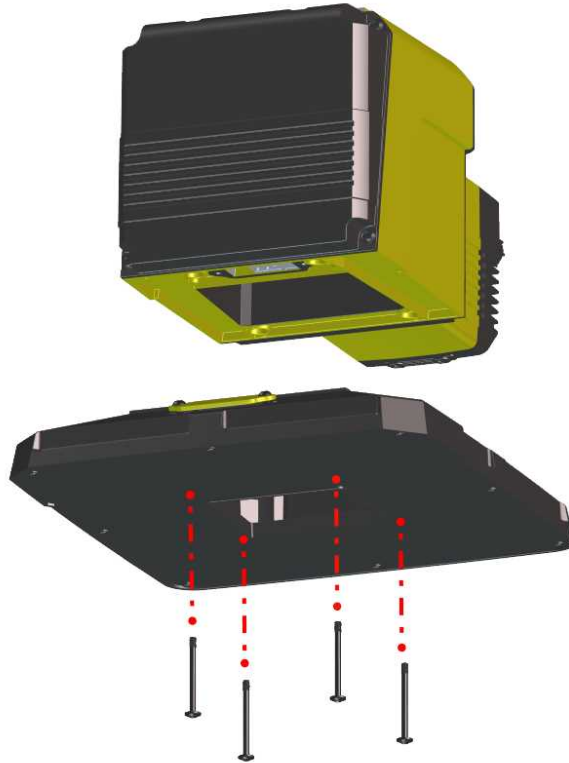

2. Remove the screws of the cover plate located on the top of the illumination attachment.

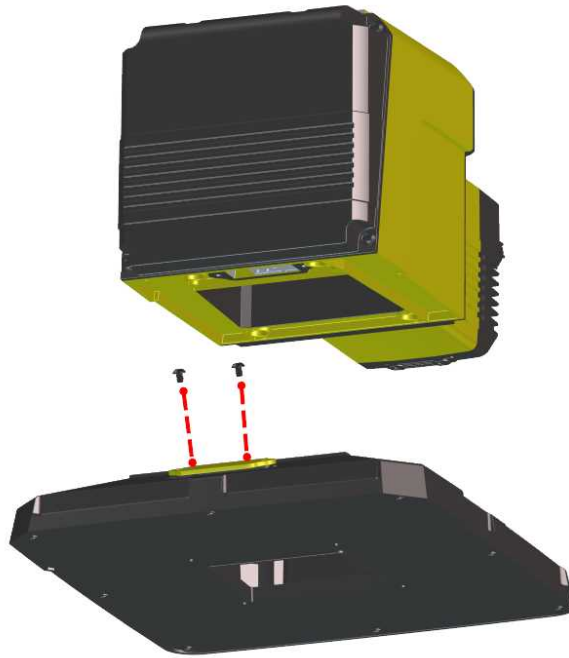

3. Pull the cover plate off from the top of the lighting attachment.

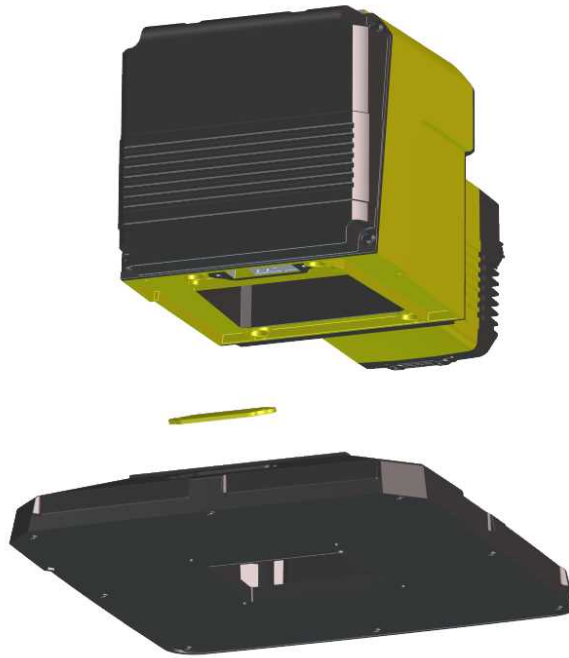

4. Install the cover plate on the underside of the main housing.

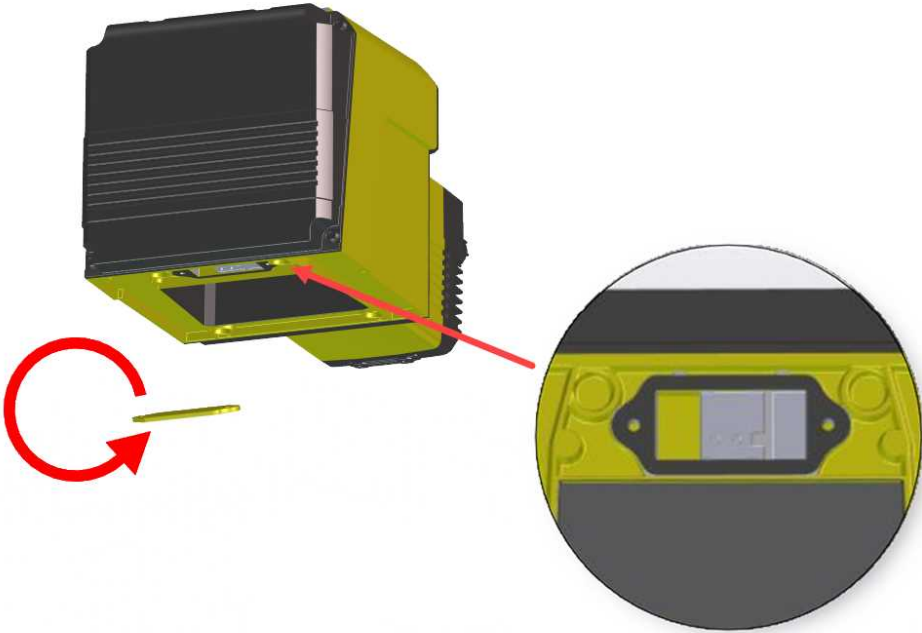

5. Fit the cover plate in place and tighten the screws with a torque value of 0.35 Nm for sealing.

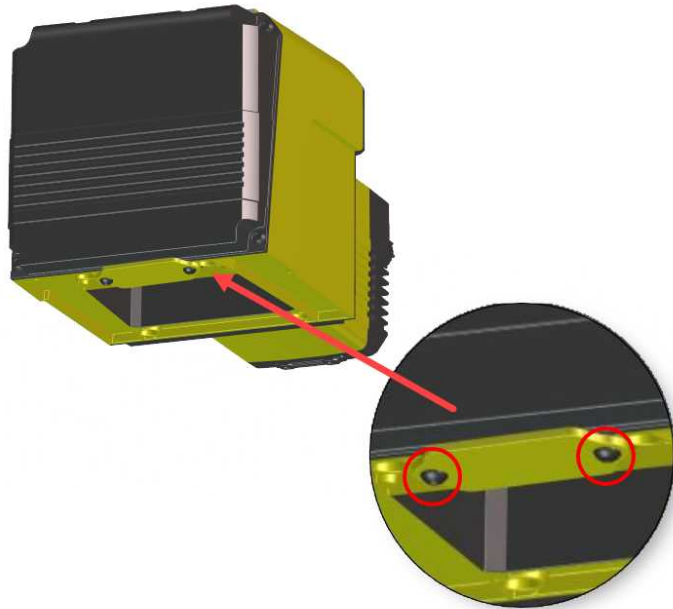

To reattach illumination attachment, follow this procedure in reversed order, then tighten the screws with a torque value of 0.35 Nm for sealing.

Additional Information

DataMan 475 Verifier Specifications

Specification	DataMan 475 Label Light	DataMan 475V DPM	DataMan 475V HD
Lighting Types	660 nm, 45°, 4-quadrant	660 nm, 45°, 4-quadrant 660 nm, 30°, 1-quadrant, 2-quadrant, 4-quadrant 660 nm, 90°	
Minimum X-Dimension	6 mil (0.15 mm)	3.75 mil (0.095 mm)	1 mil (0.025 mm)
Working Distance	60 mm	41 mm with side lighting attachment 71 mm without side lighting attachment	

Specification	DataMan 475 Label Light	DataMan 475V DPM	DataMan 475V HD
Depth of Field (Working Distance tolerance)	+/- 3 mm	5 mil symbols: +/- 1.5 mm 15 mil symbols: +/- 2.5 mm	1 mil symbols: +/- 0.2 mm 4 mil symbols: +/- 0.8 mm
Weight	945 g	1940.1 g	1900 g
Field of View	80 x 60 mm	35 x 29 mm	11 x 9 mm
Dimensions	185 x 185 x 175 mm	286 x 145 x 193 mm	360 x 145 x 193 mm
Lens Type	12 mm fixed focal length, f/4 fixed aperture, 2/3 inch sensor format, C-mount lens (you cannot alter lens)	35 mm fixed focal length, f/4 fixed aperture, 2/3 inch sensor format, C-mount lens (you cannot alter lens)	75 mm fixed focal length, f/4 fixed aperture, 2/3 inch sensor format, C-mount lens (you cannot alter lens)
Power Consumption	24 VDC ±10%, 1.5 A maximum (Label Light, 36 W peak power consumption) Supplied by LPS or NEC class 2 only.		
Light Connector	0.4 A  Note: The Light Connector is disabled while the Label Light or DPM accessory is in place.		
Case Temperature ¹	0°C – 57°C (32°F – 134.6°F)		
Operating Temperature ²	0 °C – 40°C (32 °F – 104°F)		
Storage Temperature	-20°C – 80°C (-4°F – 176°F)		
Humidity	< 95% non-condensing		
Environmental characteristics	IP67	IP65 with cable	IP65 with cable
Shock (Shipping and Storage)	IEC 60068-2-27: 18 shocks (3 shocks in each polarity in each (X, Y, Z) axis) 80 Gs (800 m/s ² at 11 ms, half-sinusoidal) with cables or cable plugs and appropriate lens cover attached.	-	-
Vibration (Shipping and Storage)	IEC 60068-2-6: vibration test in each of the three main axis for 2 hours @ 10 Gs (10 to 500 Hz at 100 m/s ² / 15 mm) with cables or cable plugs and appropriate lens cover attached.	-	-
Supported Symbologies	1D codes: Codabar, Code 39, Code 128, and Code 93, Interleaved 2 of 5, UPC/EAN/JAN 2D codes: Data Matrix (ECC 200), QR Code, microQR Code Stacked codes: PDF 417		
Maximum Codes per Second	1D: 20 codes/second* 2D: 10 codes/second*	2D: 10 codes/second*	Application Dependent
Maximum Linear Line Speed	3.6 ft/second (1.1 m/second)	4.6 ft/second (1.4 m/second)	Application Dependent

Specification	DataMan 475 Label Light	DataMan 475V DPM	DataMan 475V HD	
Coplanarity Tolerance	+/- 3° of coplanar	+/- 2° of coplanar	+/- 0.1° of coplanar	
Approvals	CE, TUV, FCC, KC			
Industry Standards Compliance	ISO/IEC 15415, ISO/IEC 15416, ISO/IEC 20158, ISO/IEC 15426-1, ISO/IEC 15426-2			
Application Standards	GS1, MIL-STD 130, UID, UDI, HIBCC, ISO/IEC 15434, Russian Crypto-code, Custom Application Standards			
Discrete I/O operating limits	HS Output 0,1,2,3	I_{MAX}	@ 12 VDC	50 mA
		R_{MIN}		200 Ω
	Input 0 (Trigger)	V_{IH}	± 15 — ± 28 V	
	Input 1,2,3	V_{IL}	0 — ± 5 V	
		I_{TYP}	@ 12 VDC @ 24 VDC	2.0 mA 4.2 mA
Ethernet Speed	10/100/1000			
Image Sensor	2/3 inch CMOS, global shutter			
Image Sensor Properties	8.8 mm x 6.6 mm (H x V); 3.45 μ m square pixels	8.5 mm x 7.1 mm (H x V); 3.45 μ m square pixels		
Image Resolution (pixels)	2448 x 2048			

1
Additional cooling measures may be required to keep the case temperature from exceeding 50°C. Examples of such measures include: extra heat sinking and/or air movement.

2
In situations where the operating temperature exceeds 40 °C, an external heat sink is required.

DataMan 475 Series Verifier Imager Specifications

Specification	DataMan 475 Imager
Image Sensor	2/3 inch CMOS, global shutter
Image Sensor Properties	DM475 Verifier: 8.8 mm x 6.6 mm (H x V); 3.45 μ m square pixels DM475 DPM and HD: 8.5 mm x 7.1 mm (H x V); 3.45 μ m square pixels
Image Resolution (pixels)	2448 x 2048
Electronic Shutter Speed	Minimum exposure: 15 μ s Maximum exposure: 5000 μ s Typically set at 30 μ s by calibration process for ISO/IEC 15415.
	Note: If the user adjusts the shutter speed, there is no guarantee that the verifier retains compliance.

Specification	DataMan 475 Imager
Image Acquisition at Full Resolution	37 Hz for imager without lighting. <div style="border: 1px solid black; padding: 2px;"> <p>Note: Max. acquisition speed with 45 lighting degree accessory enabled is significantly less. Practical acquisition rate is application dependent.</p> </div>

LED Wavelengths

The following table shows LED types and the related peak wavelengths:

LED	λ [nm]
RED	660

Compliance Information, Warnings and Notices

Precautions

To reduce the risk of injury or equipment damage, observe the following precautions when you install the Cognex product:

- The verifier is intended to be supplied by a UL or NRTL listed power supply with a 24VDC output rated for at least 2A continuous and a maximum short circuit current rating of less than 8A and a maximum power rating of less than 100VA and marked Class 2 or Limited Power Source (LPS). Any other voltage creates a risk of fire or shock and can damage the components. Applicable national and local wiring standards and rules must be followed.
- Route cables and wires away from high-current wiring or high-voltage power sources to reduce the risk of damage or malfunction from the following causes: over-voltage, line noise, electrostatic discharge (ESD), power surges, or other irregularities in the power supply.
- Do not install Cognex products where they are exposed to environmental hazards such as excessive heat, dust, moisture, humidity, impact, vibration, corrosive substances, flammable substances, or static electricity.
- Do not expose the image sensor to laser light. Image sensors can be damaged by direct, or reflected, laser light. If your application requires laser light that might strike the image sensor, use a lens filter at the corresponding laser wavelength. For suggestions, contact your local integrator or application engineer.
- Changes or modifications not expressly approved by the party responsible for regulatory compliance could void the user's authority to operate the equipment.
- Include service loops with cable connections.
- Ensure that the cable bend radius begins at least six inches from the connector. Cable shielding can be degraded or cables can be damaged or wear out faster if a service loop or bend radius is tighter than 10X the cable diameter.
- This device should be used in accordance with the instructions in this manual.
- All specifications are for reference purposes only and can change without notice.

Regulations/Conformity

Note: For the most current CE and UKCA declaration and regulatory conformity information, see the Cognex support site: cognex.com/support.

DataMan 475 Verifier has Regulatory Model R00062, Label Light (DMV-475V-LBL-0200) has Accessory Model 50162, and meet or exceed the requirements of all applicable standards organizations for safe operation. However, as with any electrical equipment, the best way to ensure safe operation is to operate them according to the agency guidelines that follow. Please read these guidelines carefully before using your device.

Safety and Regulatory	
Manufacturer	Cognex Corporation One Vision Drive Natick, MA 01760 USA
USA	TÜV SÜD SCC/NRTL OSHA Scheme for UL/CAN 61010-1. FCC Part 15, Class A This equipment has been tested and found to comply with the limits for a Class A digital device, pursuant to part 15 of the FCC Rules. These limits are designed to provide reasonable protection against harmful interference when the equipment is operated in a commercial environment. This equipment generates, uses, and can radiate radio frequency energy and, if not installed and used in accordance with the instruction manual, may cause harmful interference to radio communications. Operation of this equipment in a residential area is likely to cause harmful interference in which case the user will be required to correct the interference at his own expense.
Canada	TÜV SÜD SCC/NRTL OSHA Scheme for UL/CAN 61010-1. ICES-003, Class A This Class A digital apparatus complies with Canadian ICES-003. Cet appareil numérique de la classe A est conforme à la norme NMB-003 du Canada.
Europe	DM475 (Regulatory Model R00062) Label Light (DMV-475V-LBL-0200) (Accessory Model 50162) The CE mark on the product indicates that the system has been tested to and conforms to the provisions noted within the 2014/30/EU Electromagnetic Compatibility Directive and the 2011/65/EU RoHS Directive. For further information, please contact: Cognex Corporation, One Vision Drive, Natick, MA 01760, USA. Cognex Corporation shall not be liable for use of our product with equipment (i.e., power supplies, personal computers, etc.) that is not CE.
Korea	A급 기기(업무용 방송통신기자재): 이 기기는 업무용(A급) 전자파적합기기로서 판매자 또는 사용자는 이 점을 주의하시기 바라며, 가정외의 지역에서 사용하는 것을 목적으로 합니다. DM475 (Regulatory Model R00062) Label Light (DMV-475V-LBL-0200) (Accessory Model 50162)
International Product Safety	Conforms to IEC 61010-1, CAN/CSA-C22.2 No. 61010-1:2012 + UPD No. 1:2015-07, UL 61010-1:2012 + R:2015-07, UL 61010-1:2012 + R:2015-07, EN 61010-1:2010.
CB	TÜV SÜD, IEC/EN 61010-1. CB report available upon request.

For European Community Users

Cognex complies with Directive 2012/19/EU OF THE EUROPEAN PARLIAMENT AND OF THE COUNCIL of 4 July 2012 on waste electrical and electronic equipment (WEEE).

This product has required the extraction and use of natural resources for its production. It may contain hazardous substances that could impact health and the environment, if not properly disposed.

In order to avoid the dissemination of those substances in our environment and to diminish the pressure on the natural resources, we encourage you to use the appropriate take-back systems for product disposal. Those systems will reuse or recycle most of the materials of the product you are disposing in a sound way.



The crossed out wheeled bin symbol informs you that the product should not be disposed of along with municipal waste and invites you to use the appropriate separate take-back systems for product disposal.

If you need more information on the collection, reuse, and recycling systems, please contact your local or regional waste administration.

You may also contact your supplier for more information on the environmental performance of this product.

