

DataMan[®] 380 Series Reference Manual



2024 October 01
Revision: 24.3.0.11

Legal Notices

The software described in this document is furnished under license, and may be used or copied only in accordance with the terms of such license and with the inclusion of the copyright notice shown on this page. Neither the software, this document, nor any copies thereof may be provided to, or otherwise made available to, anyone other than the licensee. Title to, and ownership of, this software remains with Cognex Corporation or its licensor. Cognex Corporation assumes no responsibility for the use or reliability of its software on equipment that is not supplied by Cognex Corporation. Cognex Corporation makes no warranties, either express or implied, regarding the described software, its merchantability, non-infringement or its fitness for any particular purpose.

The information in this document is subject to change without notice and should not be construed as a commitment by Cognex Corporation. Cognex Corporation is not responsible for any errors that may be present in either this document or the associated software.

Companies, names, and data used in examples herein are fictitious unless otherwise noted. No part of this document may be reproduced or transmitted in any form or by any means, electronic or mechanical, for any purpose, nor transferred to any other media or language without the written permission of Cognex Corporation.

Copyright © 2024. Cognex Corporation. All Rights Reserved.

Portions of the hardware and software provided by Cognex may be covered by one or more U.S. and foreign patents, as well as pending U.S. and foreign patents listed on the Cognex web site at: cognex.com/patents.

The following are registered trademarks of Cognex Corporation:

Cognex, 2DMAX, Advantage, AlignPlus, Assemblyplus, Check it with Checker, Checker, Cognex Vision for Industry, Cognex VSOC, CVL, DataMan, DisplayInspect, DVT, EasyBuilder, Hotbars, IDMax, In-Sight, Laser Killer, MVS-8000, OmniView, PatFind, PatFlex, PatInspect, PatMax, PatQuick, SensorView, SmartView, SmartAdvisor, SmartLearn, UltraLight, Vision Solutions, VisionPro, VisionView

The following are trademarks of Cognex Corporation:

The Cognex logo, 1DMax, 3D-Locate, 3DMax, BGAll, CheckPoint, Cognex VSoC, CVC-1000, FFD, iLearn, In-Sight (design insignia with cross-hairs), In-Sight 2000, InspectEdge, Inspection Designer, MVS, NotchMax, OCRMax, PatMax RedLine, ProofRead, SmartSync, ProfilePlus, SmartDisplay, SmartSystem, SMD4, VisiFlex, Xpand

Portions copyright © Microsoft Corporation. All rights reserved.

Portions copyright © MadCap Software, Inc. All rights reserved.

Other product and company trademarks identified herein are the trademarks of their respective owners.

Precautions

To reduce the risk of injury or equipment damage, observe the following precautions when you install the Cognex product:

- Connectivity is possible through the following options:
 - 24 VDC (+/- 10%) output connection using a UL or NTRL listed power supply

Any other voltage creates a risk of fire or shock and can damage the components. Applicable national and local wiring standards and rules must be followed.

- This product is intended for industrial use in automated manufacturing or similar applications.
- The safety of any system incorporating this product is the responsibility of the assembler of the system.
- Do not install Cognex products where they are exposed to environmental hazards such as excessive heat, dust, moisture, humidity, impact, vibration, corrosive substances, flammable substances, or static electricity.
- Route cables and wires away from high-current wiring or high-voltage power sources to reduce the risk of damage or malfunction from the following causes: over-voltage, line noise, electrostatic discharge (ESD), power surges, or other irregularities in the power supply.
- Do not expose the image sensor to laser light. Image sensors can be damaged by direct, or reflected, laser light. If your application requires laser light that might strike the image sensor, use a lens filter at the corresponding laser wavelength. For suggestions, contact your local integrator or application engineer.
- This product does not contain user-serviceable parts. Do not make electrical or mechanical modifications to product components. Unauthorized modifications can void your warranty.
- Changes or modifications not expressly approved by the party responsible for regulatory compliance could void the user's authority to operate the equipment.
- Include service loops with cable connections.
- Ensure that the cable bend radius begins at least six inches from the connector. Cable shielding can be degraded or cables can be damaged or wear out faster if a service loop or bend radius is tighter than 10X the cable diameter.
- This device should be used in accordance with the instructions in this manual.
- All specifications are for reference purposes only and can change without notice.

Symbols

The following symbols indicate safety precautions and supplemental information:

 **WARNING:** This symbol indicates a hazard that could cause death, serious personal injury or electrical shock.

 **CAUTION:** This symbol indicates a hazard that could result in property damage.

 **Note:** This symbol indicates additional information about a subject.

 **Tip:** This symbol indicates suggestions and shortcuts that might not otherwise be apparent.

Table of Contents

Legal Notices	2
Precautions	3
Symbols	4
Table of Contents	5
Getting Started	7
About the DataMan 380 Series	7
Supporting Documentation	8
Accessories	9
Lenses	9
Lens Covers	9
Mounting Brackets	9
Cables	10
Integrated Lights	11
Illumination Options	12
DataMan 380 Series Systems	12
Setting Up Your DataMan Reader	13
Reader Layout	14
Indicator LEDs	16
Dimensions	17
DataMan 380 Reader Only	17
DataMan 380 with 45 mm Lens Cover	18
DataMan 380 with 60 mm Lens Cover	19
DataMan 380 with 75 mm Lens Cover	20
DataMan 380 with HPIT	21
Field of View and Distance	22
DataMan 3808 Field of View	22
16 mm Focal Length	22
25 mm Focal Length	23
DataMan 3812 Field of View	24
16 mm Focal Length	24
25 mm Focal Length	25
DataMan 3816 Field of View	26
16 mm Focal Length	26
25 mm Focal Length	27
Installing Lenses and HPIT	28
Installing Manual Lens with HPIT	28
Installing High Speed Liquid Lens with HPIT	30
Change Manual Lens to Liquid Lens	31
Add a Lens Cover	32
Lens Cover Compatibility	32
Installing a Lens Cover	32

Mounting the Reader	35
Mounting with Pivot Bracket	35
Mounting with U-shaped Bracket for HPIT	37
Connection Options	40
Connecting the Ethernet Cable	40
Connecting the Power and I/O Breakout Cable	40
Powering the Integrated Illumination	41
Internal Power	41
External Power	41
Using your Device through USB	42
Emulating Serial Functionality	42
Using Your DataMan Reader	43
Installing the DataMan Setup Tool	43
Trigger Types	43
External Triggers	44
Industrial Protocols	44
Specifications	45
DataMan 380 Series Reader	45
DataMan 380 Series Reader Image Sensor	46
LED Wavelengths	46
Acquisition Trigger Input	47
High-Speed Outputs	47
Ethernet Cable	49
Breakout Cable	50
External Light Connector	51
CCB-M12x12Fy-xx	51
CCBL-05-01	53
CCB-PWRIO-05	54
Cleaning and Maintenance	55
Clean the Housing	55
Clean the Reader Image Sensor Window	55
Clean the Reader Lens Cover	55
Regulations and Conformity	56
中国大陆RoHS (Information for China RoHS Compliance)	57
For European Community Users	57

Getting Started

This section provides general information about the DataMan 380 series reader and the accessories and systems.

About the DataMan 380 Series

The DataMan 380 series readers are high-performance readers that offer:

- Maximum coverage and throughput in a single device
- Unmatched 1D + 2D decoding performance
- Flexible and modular design for any application



Supporting Documentation

This document provides basic information about the DataMan 380 series readers. Additional information is available through the Windows **Start** menu or the DataMan Setup Tool **Help** menu after you install the DataMan software on your PC.



Note: For the latest documentation, visit: support.cognex.com/documentation/dataman.

- The **DataMan Communications and Programming Guide** shows you how to integrate your DataMan reader into your particular automation and factory environment.
Cognex > DataMan Software Revision: x.x.x> Documentation > Communications > DataMan Communications and Programming Guide
- The **DataMan Industrial Protocols Manual** provides information on how to integrate DataMan readers into your particular environment using industrial protocols.
Cognex > DataMan Software Revision: x.x.x> Documentation > Communications > DataMan Industrial Protocols Manual
- The **DataMan Reader Configuration Codes** document provides printable 2-D codes that you can use to configure the DataMan reader.
Cognex > DataMan Software Revision: x.x.x > Documentation > English > Reader Configuration Codes
- The **DM380 Quick Reference Guide** provides essential information about the DM380 reader.
Cognex > DataMan Software Revision: x.x.x > Documentation > English > DM380 Series > DM380 Quick Reference Guide
- The **DataMan Fixed-Mount Readers Reference** is a complete online hardware reference for the DataMan fixed-mount ID readers.
Cognex > DataMan Software Revision: x.x.x > Documentation > English > DM380 > Fixed-Mount Reference Manual
- The **DataMan Questions and Answers** document provides context-sensitive information. You can view this help inside the DataMan Setup Tool or as a stand-alone help file.
Cognex > DataMan Software Revision: x.x.x > Documentation > DM380 > Questions and Answers
- The **DataMan Control Commands** lists DataMan Control Commands with all relevant information. You can view this help inside the Setup Tool or as a stand-alone help file.
Cognex > DataMan Software Revision: x.x.x > Documentation > English > DataMan Control Commands
- The **Setup Tool Reference Manual** describes the user interface of the DataMan Setup Tool software.
Cognex > DataMan Software Revision: x.x.x> Documentation > English > Setup Tool Reference Manual
- The **Release Notes** list detailed system requirements and additional information about the DataMan software release.
Cognex > DataMan Software Revision: x.x.x > Documentation > DataMan Revision: x.x.x > Release Notes





Accessories

You can purchase the following components separately. For a list of options and accessories, contact your local Cognex sales representative.

Lenses

Accessory	Product Number	Illustration
16 mm f6.5 Cognex High-Res - Visible Light Only	CLN-C16F06-UR	
25 mm f6.5 Cognex High-Res - Visible Light Only	CLN-C25F06-UR	
35 mm f6.5 Cognex High-Res - Visible Light Only	CLN-C35F06-UR	
12 mm Variable Aperture Moritex SR Series	LMC-ML-U1217SR	
16 mm Variable Aperture Moritex SR Series	LMC-ML-U1615SR	
25 mm Variable Aperture Moritex SR Series	LMC-ML-U2515SR	
35 mm Variable Aperture Moritex SR Series	LMC-ML-U3518SR	
50 mm Variable Aperture Moritex SR Series	LMC-ML-U5022SR	
16 mm f6.5 Cognex High Speed Liquid Lens for High-Res	CLN-C16F65-HSLL-HR	
25 mm f6.5 Cognex High Speed Liquid Lens for High-Res	CLN-C25F65-HSLL-HR	
35 mm f6 Cognex High Speed Liquid Lens for High-Res	CLN-C35F06-HSLL-HR	

Lens Covers

Accessory	Product Number	Illustration
45 mm Plastic Lens Cover	COV-380-CMNT-45	
60 mm Plastic Lens Cover	COV-380-CMNT-60	
75 mm Plastic Lens Cover	COV-380-CMNT-75	
30 mm Lens Cover Extender	COV-7000-CMNT-LGX	

Note: A reader with HPIT does not need a lens cover.













Mounting Brackets

Accessory	Product Number	Illustration
Pivot mounting bracket	DMBK-PIVOT-DM380	

Accessory	Product Number	Illustration
U-shaped mounting bracket for use with HPIT	DMBK-PVT-HPIT-380	

Cables

Note: Cables are sold separately.

Accessory	Product Number	Illustration
Ethernet Cable, X-coded M12-8 to RJ-45	CCB-84901-2001-xx (straight, xx specifies length: 2m, 5m, 10m, 15m, 30m)	
Ethernet Cable, X-coded M12-8 to RJ-45	CCB-84901-2002-xx (right-angled, xx specifies length: 2m, 5m, 10m)	
Ethernet Cable, Robotic X-Coded M12-8 to RJ-45	CCB-84901-2RBT-xx (straight, xx specifies length: 2m, 5m, 10m)	
X-Coded to A-Coded Ethernet cable adapter, 0.5 m	CCB-M12X8MS-XCAC	
Power and I/O Breakout Cable, M12-12 to Flying Lead	CCB-M12x12Fy-05 (y = straight/angled, xx specifies length)	
Power and I/O Breakout Cable, M12-12 to Flying Lead	CCBL-05-01	
Power and I/O Breakout Cable, M12-12 to Flying Lead	CCB-PWRIO- xx (straight, xx specifies length: 5m, 10m, 15m)	
Power and I/O Breakout Cable, M12-12 to Flying Lead	CCB-PWRIO-xxR (right-angled, xx specifies length: 5m, 10m, 15m)	
Power and I/O Breakout Cable, M12-12 to DB15	CCB-PWRIO-MOD-xx (xx specifies length: 2m, 5m)	
USB Type C Cable to USB Type A, Straight, 2.5 m	DMA-STCBLE-IP65-25	
USB Type C Cable to USB Type A, Angled, 2.5 m	DMA-RTCBLE-IP65-25	
External Light Cable, Yellow	IVSL-5PM12-J300 IVSL-5PM12-J500 IVSL-5PM12-J1000 IVSL-5PM12-J2000	
Note: This cable supports intensity control.		
External Light Cable, Black	IVSL-M12-NSB-300 IVSL-M12-NSB-1000 IVSL-M12-NSB-2000	
Note: This cable supports intensity control and is used with standard SVL lights.		

Integrated Lights

Accessory	Illustration
High-Powered Integrated Torch (HPIT), red, white, clear and polarized variants Accessory Model 50190 Please contact Cognex sales for more details.	

⚠ WARNING: High-Powered Integrated Torch devices equipped with a Time-of-Flight sensor, the device has been tested to be under the limits of a Class 1 Laser device.



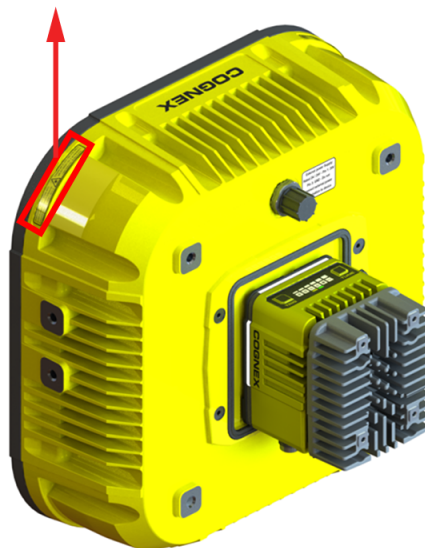

⚠ CAUTION: High-Powered Integrated Torch devices equipped with a target aimer have been tested in accordance with IEC 60825-1, 3rd ed. 2014, and have been certified to be under the limits of a Class 2 Laser device.

LASER LIGHT - DO NOT STARE INTO BEAM
 CLASS 2 LASER PRODUCT 515nm<1mW
 CLASSIFIED PER IEC 60825-1, Ed 3, 2014
 
 Complies with 21 CFR 1040.10 & 1040.11 except
 for conformance with IEC 60825-1 Ed. 3. as
 described in Laser Notice No. 56, May 8, 2019



Illumination Options

LED Type	Power	Maximum Exposure Time	Maximum High-Frequency Illumination Time
 HPIT Red	Internal	10 ms	100 μ s
	External	10 ms	500 μ s
 HPIT White	Internal	4 ms	75 μ s
	External	4 ms	200 μ s

For more information on how HPIT power options, see [Powering the Integrated Illumination on page 41](#).

DataMan 380 Series Systems

	Omnidirectional 1D Codes	Omnidirectional 1D/2D Codes	Multi-Reader Sync	Resolution
DM3808QL	✓		✓	2840 × 2840
DM3808X		✓	✓	
DM3812QL	✓		✓	4096 × 3000
DM3812X		✓	✓	
DM3816QL	✓		✓	5320 × 3032
DM3816X		✓	✓	

Setting Up Your DataMan Reader

Read this section to learn how the reader connects to its standard components and accessories.

Note:



- Cables are sold separately.
- If a standard component is missing or damaged, immediately contact your Cognex Authorized Service Provider (ASP) or Cognex Technical Support.



CAUTION: All cable connectors are keyed to fit the connectors on the reader. Do not force the connections or damage may occur.

Reader Layout

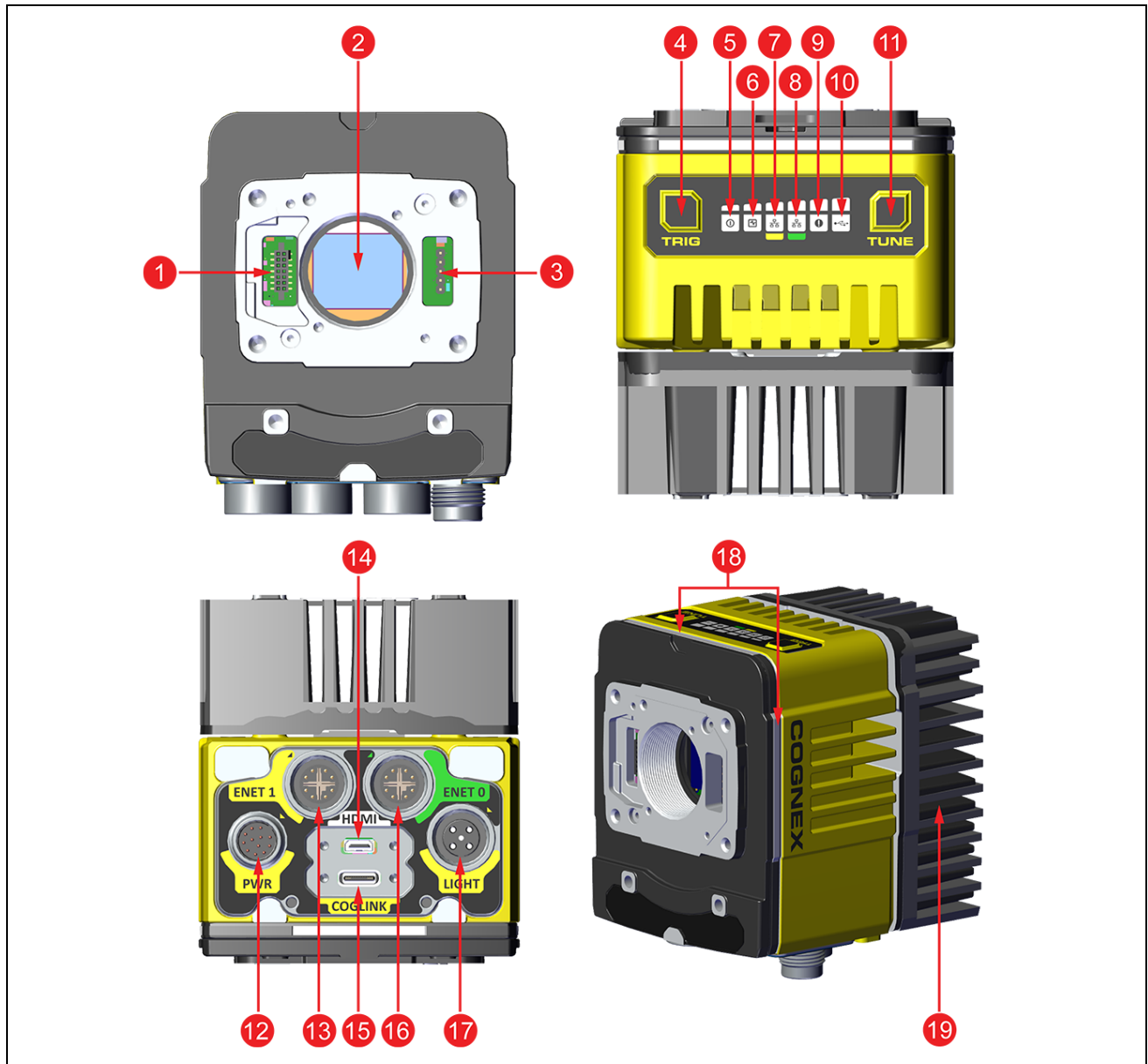

Number	Description
1	Integrated Illumination connector
2	Imager/C-mount flange
3	Lens connector
4	Trigger button
5	Power LED indicator
6	Train status LED indicator
7	Ethernet 1 status LED
8	Ethernet 0 status LED

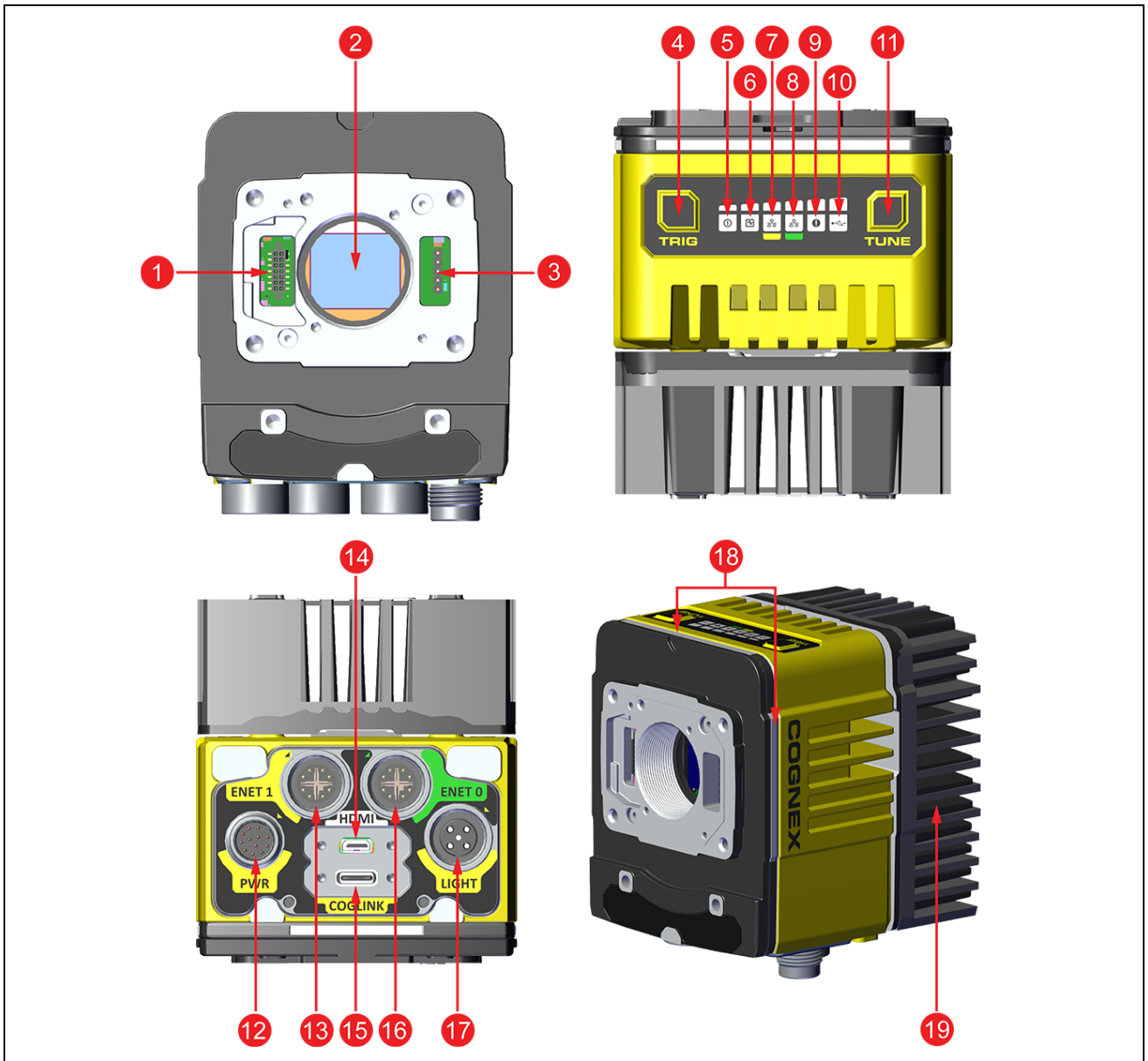

9	Error LED indicator
10	Coglink/USB-C status LED
11	Tune button
12	Power I/O Breakout cable connector
13	Ethernet connector 1
14	Micro-HDMI connector
15	Coglink/USB-C connector
16	Ethernet connector 0
17	Light connector
18	Indicator lights
19	Heatsink

Indicator LEDs

The table summarizes the functions of the indicator LEDs on DataMan 380 readers.

Indicator	Color/Status	Meaning
User indicator LEDs	GREEN, blinking	Light edges blink in GREEN when the device performs a good read. Note: In case of a good read, the Good/Bad read indicator LED is also blinking in GREEN.
	RED, blinking	Light edges blink in RED when the device performs a bad read when it does not find a decoding after a timeout. Note: In case of a bad read, the Good/Bad read indicator LED is also blinking in RED.
	WHITE	Light edges are WHITE when you trigger the Identify function in DataMan Setup Tool. For more information, see <i>DataMan Setup Tool Reference Manual</i> .
Power indicator LED	ON	The device is ON.
	OFF	The device is OFF.
Train/Trigger status indicator LED	ON	If the device has a trained code, this LED is GREEN.
	OFF	If the device has no trained code, this LED is OFF.
Good/Bad read indicator LED	GREEN, blinking	The device performs a good read. Note: In case of a good read, light edges are also blinking in GREEN.
	RED, blinking	The device performs a bad read when it does not find a decoding after a timeout. Note: In case of a bad read, light edges are also blinking in RED.
Communication LEDs	ON	This LED is on when the DataMan 380 established the Ethernet connection.
	OFF	This LED is OFF when there is no Ethernet connection.
Error	ON	This LED is on if the DataMan 380 reader detects an error.

Dimensions

The following sections list dimensions of the reader.

Note:



- Dimensions are in millimeters and are for reference purposes only.
- All specifications are for reference purposes only and can change without notice.

DataMan 380 Reader Only

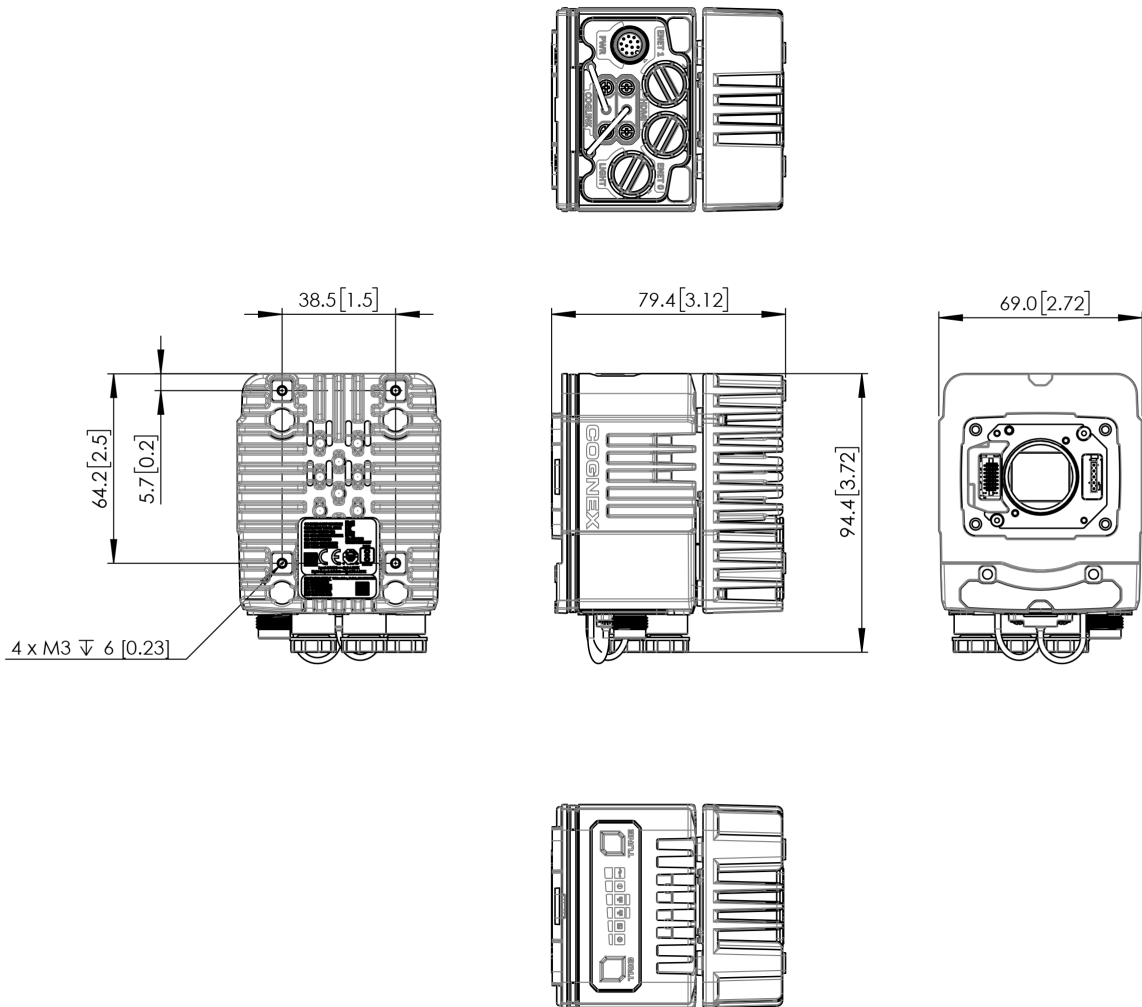

DataMan 380 with 45 mm Lens Cover

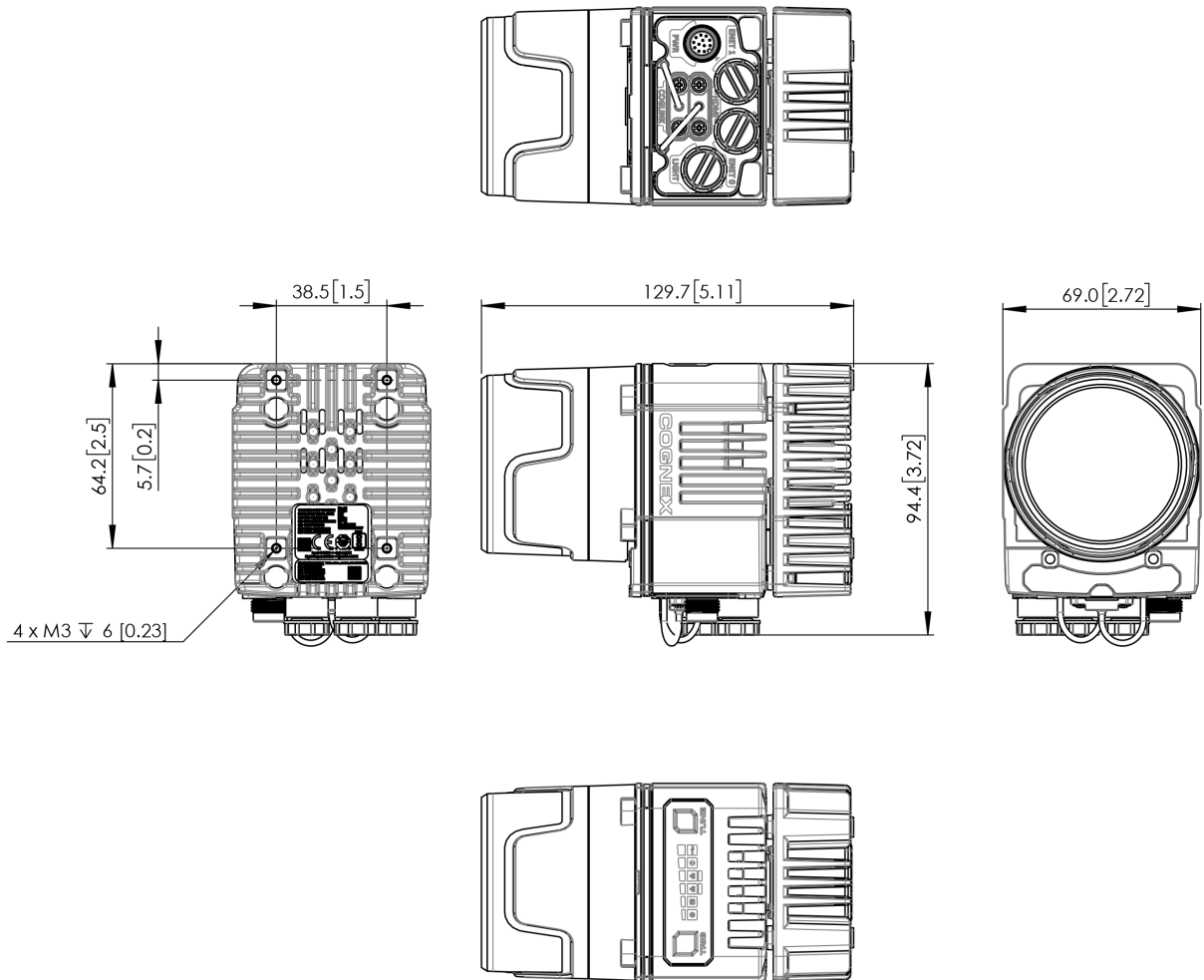

DataMan 380 with 60 mm Lens Cover

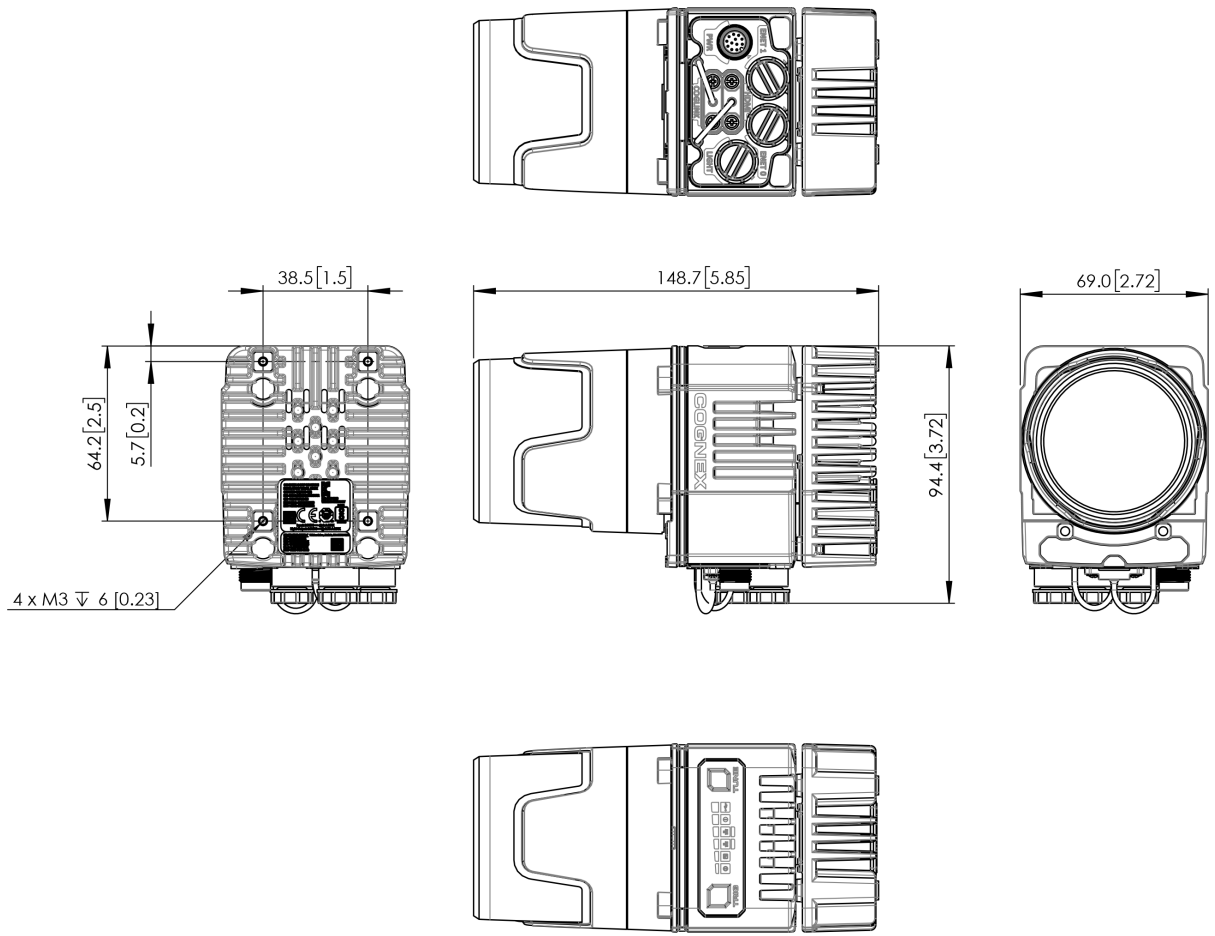

DataMan 380 with 75 mm Lens Cover

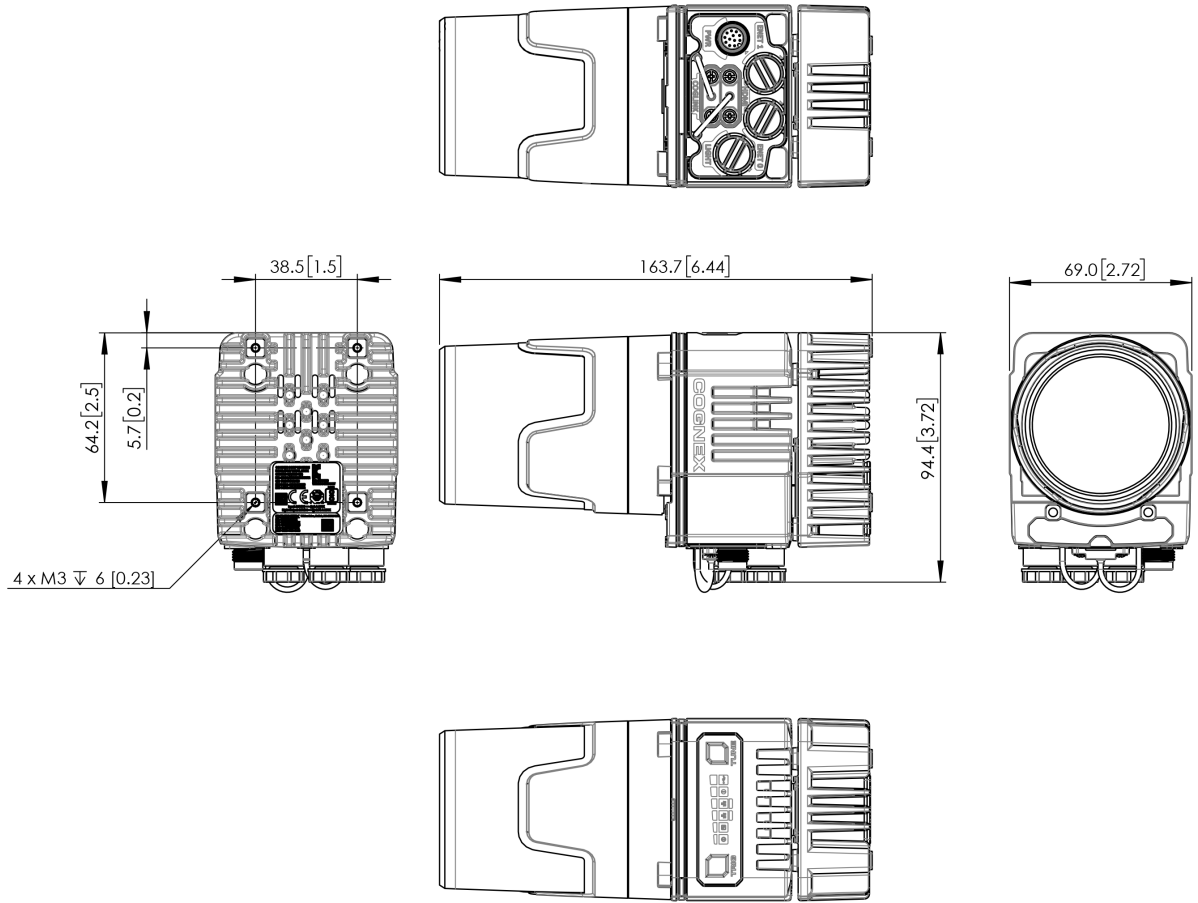

DataMan 380 with HPIT

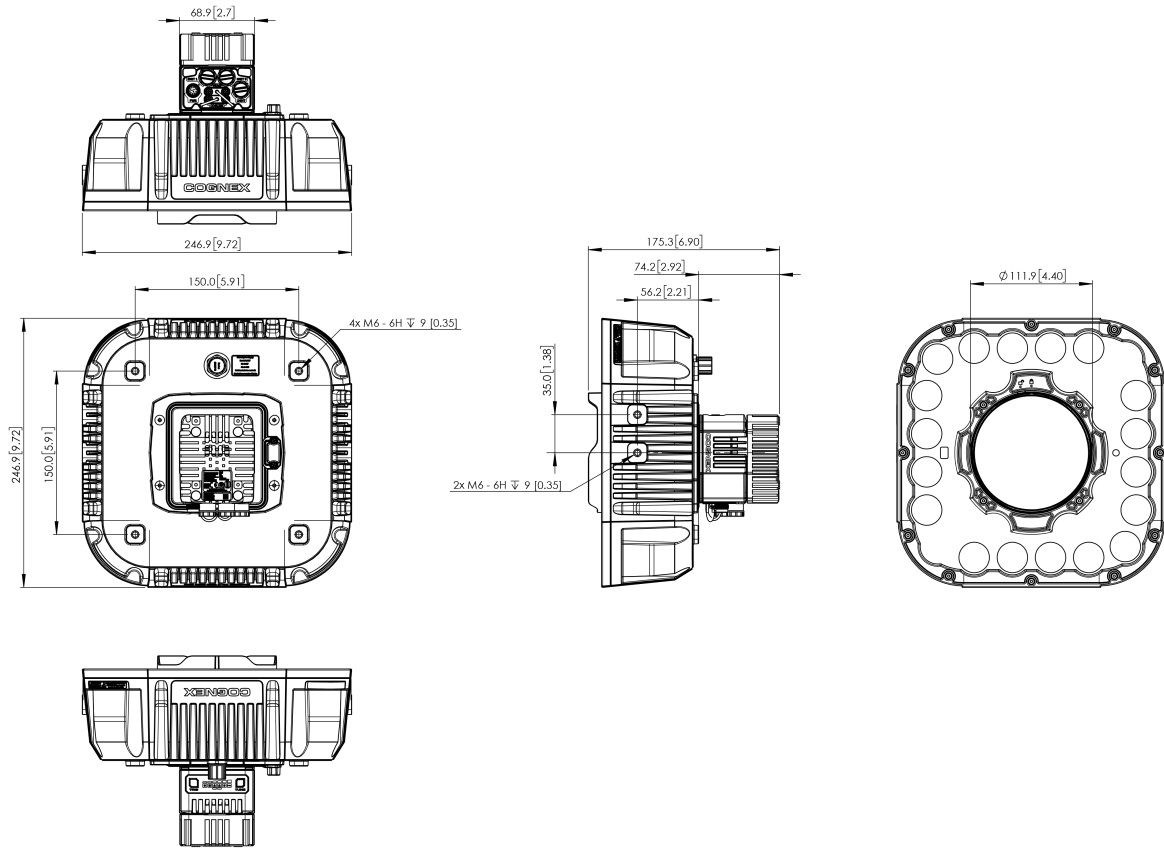

Field of View and Distance

This section provides the Field of View (FoV) values for 16 mm and 25 mm lenses.

DataMan 3808 Field of View

16 mm Focal Length

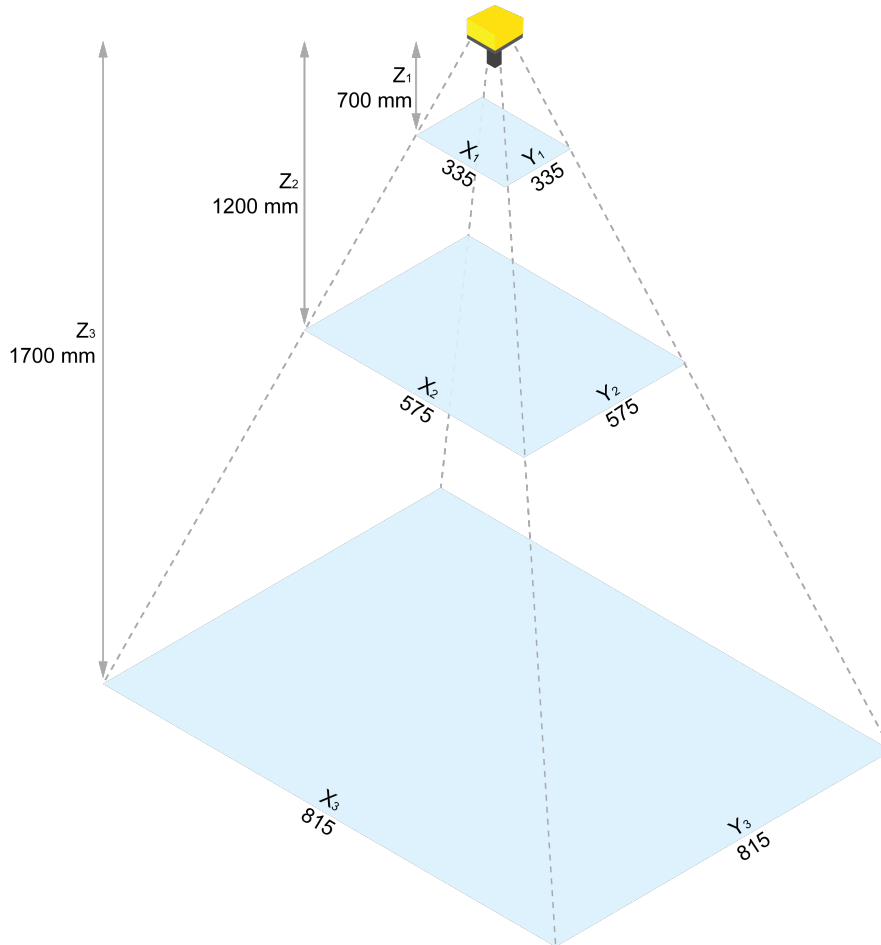

Working Distance in mm	Horizontal Values in mm	Vertical Values in mm
700	335	335
1200	575	575
1700	815	815

25 mm Focal Length

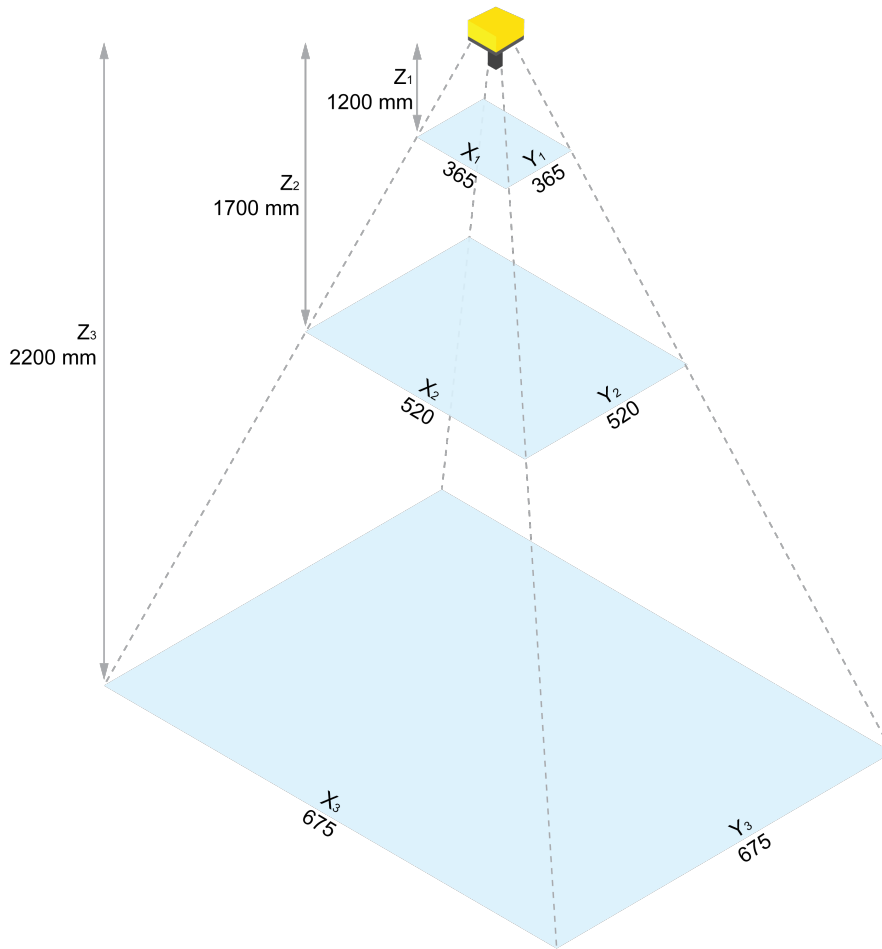

Working Distance in mm	Horizontal Values in mm	Vertical Values in mm
1200	365	365
1700	520	520
2200	675	675

DataMan 3812 Field of View

16 mm Focal Length

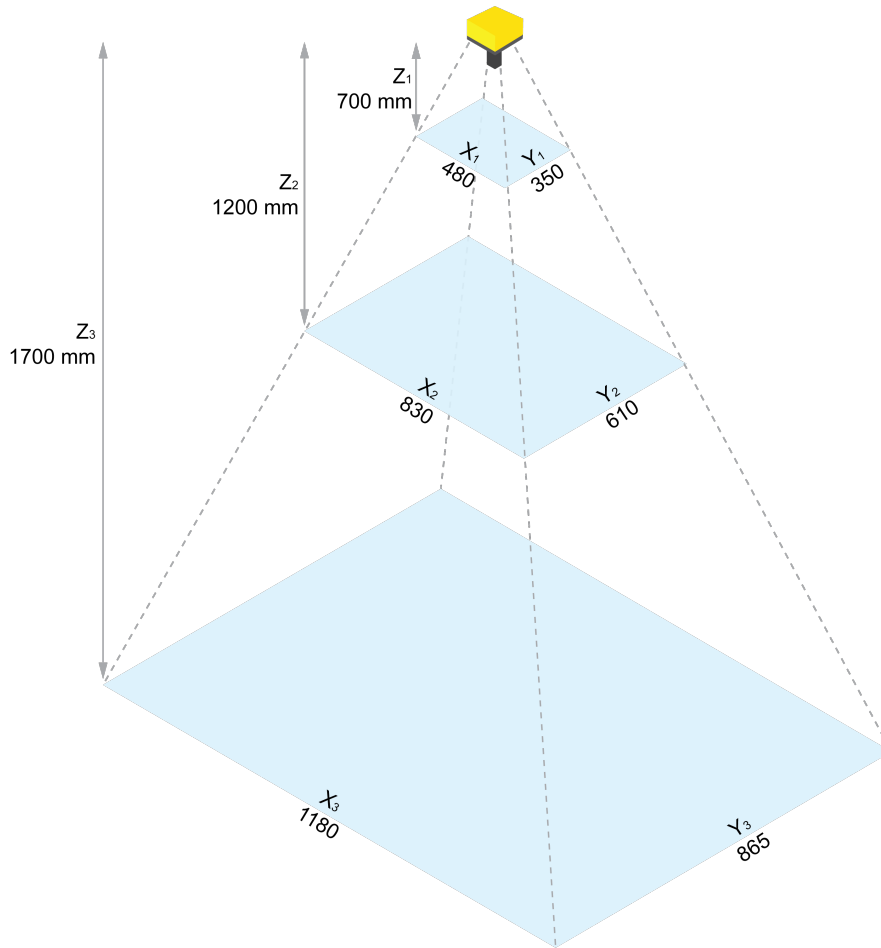

Working Distance in mm	Horizontal Values in mm	Vertical Values in mm
700	480	350
1200	830	610
1700	1180	865

25 mm Focal Length

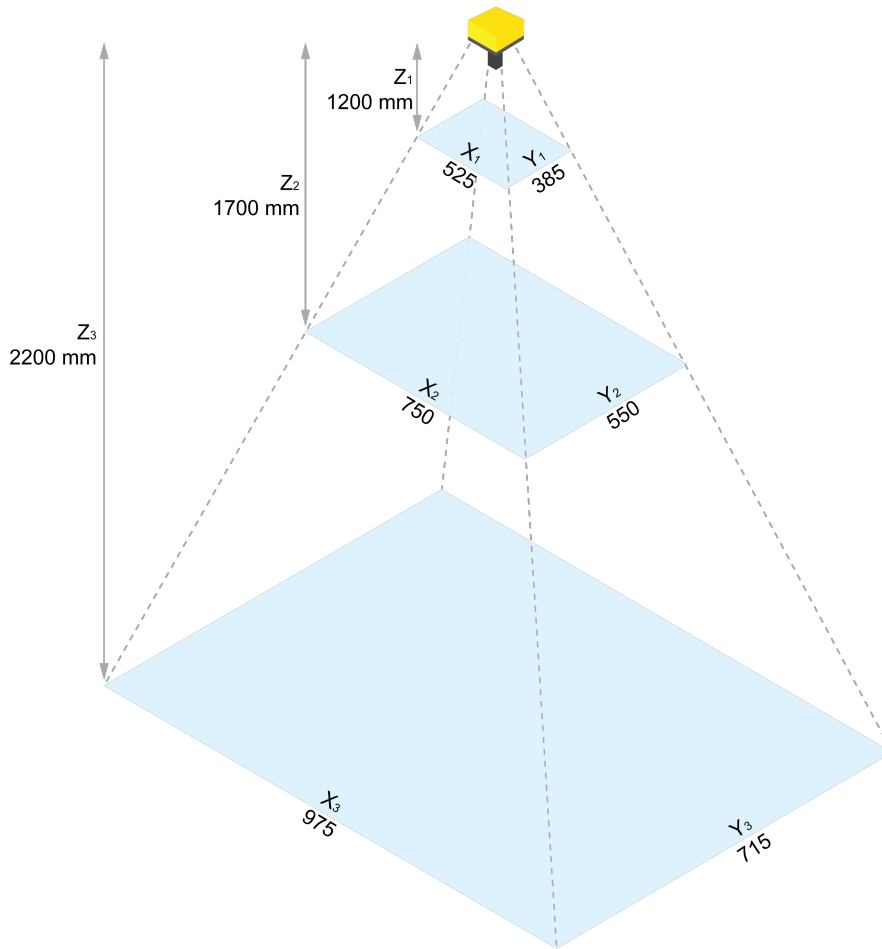

Working Distance in mm	Horizontal Values in mm	Vertical Values in mm
1200	525	385
1700	750	550
2200	975	715

DataMan 3816 Field of View

16 mm Focal Length

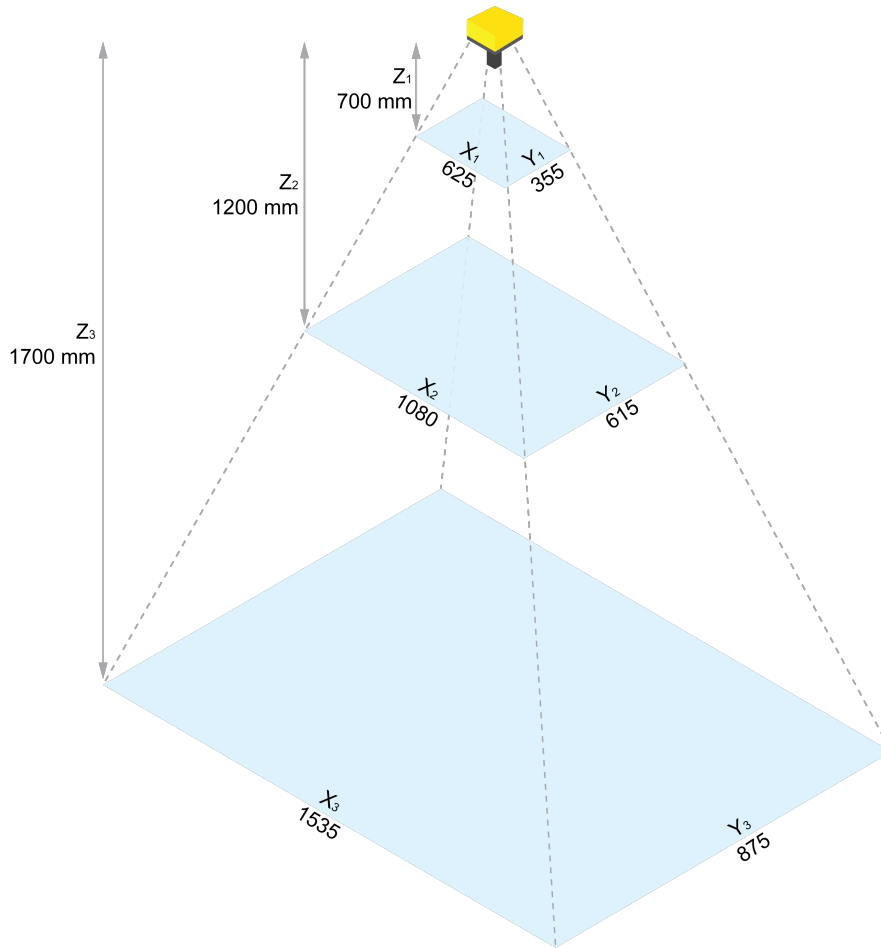

Working Distance in mm	Horizontal Values in mm	Vertical Values in mm
700	625	355
1200	1080	615
1700	1535	875

25 mm Focal Length

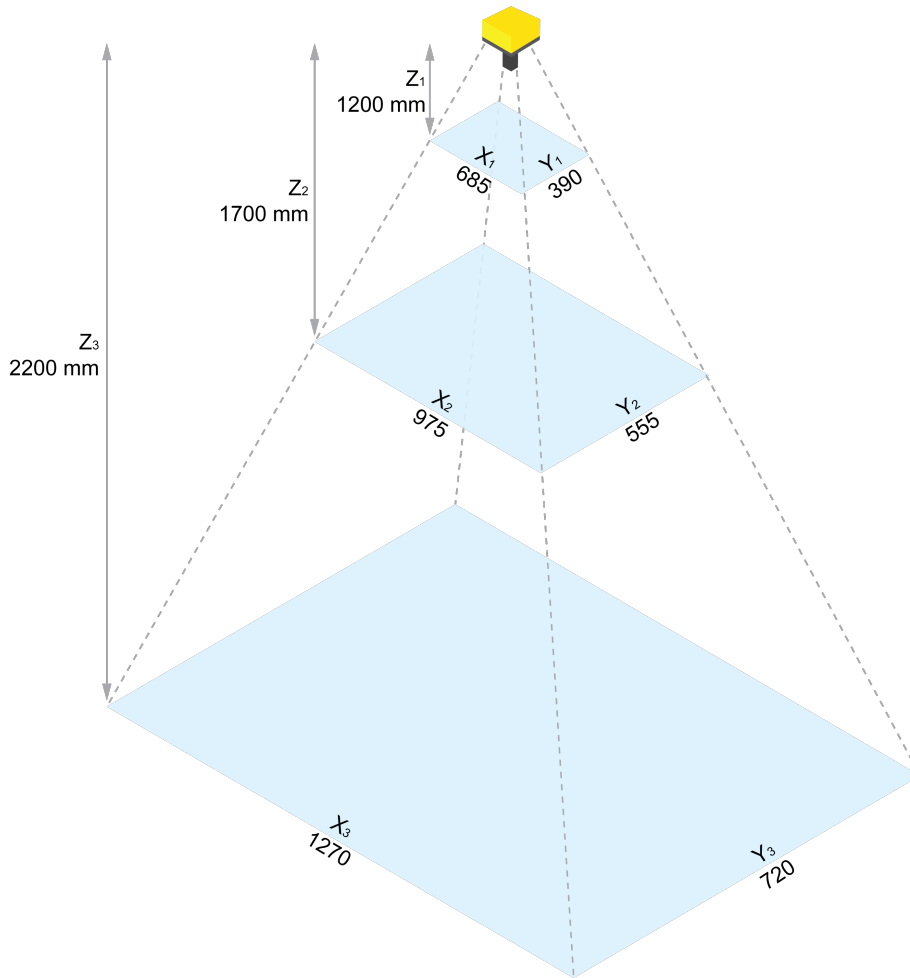

Working Distance in mm	Horizontal Values in mm	Vertical Values in mm
1200	685	390
1700	975	555
2200	1270	720

Installing Lenses and HPIT

Installing Manual Lens with HPIT

1. Snap the cable into the reader.

Note: Use caution when installing the cable. Connect the side with the black cover to the reader, and connect the side with the 2D code to the HPIT.



2. Twist in the manual lens.

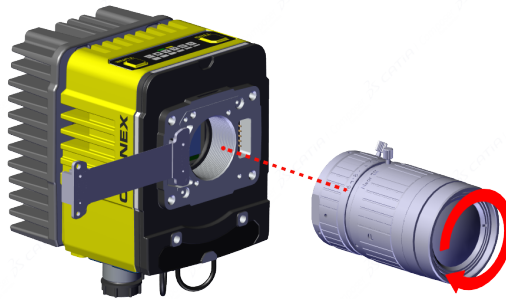

3. Bend the other end of the cable and feed the cable through the back of the illumination module.

Note: Only snap the cable into place after you have completely attached the reader to the illumination module with the screws. Otherwise, the cable might break.

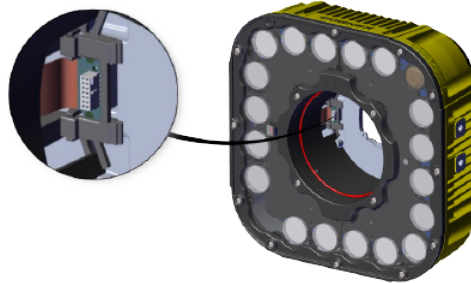

4. Screw in the four screws from the illumination module into the reader.

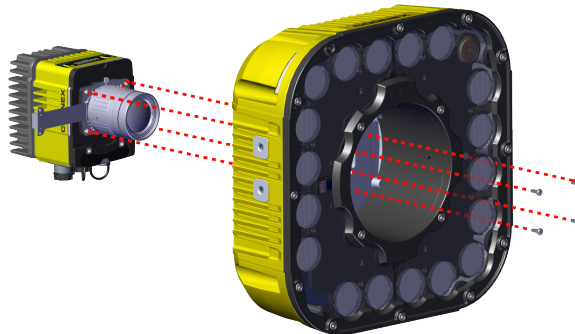

5. Snap the cable into place in the illumination module.
6. Align the slots in the cover with the illumination module. Twist slightly to lock it in.

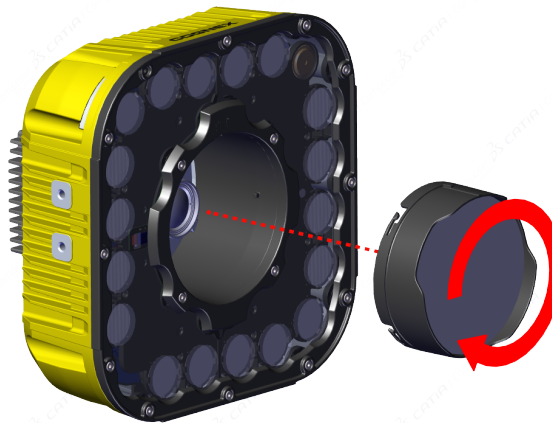

Installing High Speed Liquid Lens with HPIT

1. Snap the cable into the reader. Connect the side with the black cover to the reader, and connect the side with the 2D code to the HPIT.

Note: Use caution when installing the cable.



2. Screw in the four screws to attach the lens to the reader.



3. Bend the other end of the cable and feed the cable through the back of the illumination module.

Note: Only snap the cable into place after you have completely attached the reader to the illumination module with the screws. Otherwise, the cable can break.

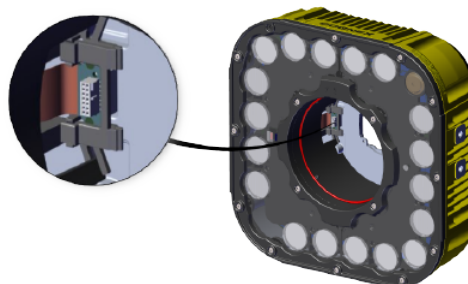

4. Screw in the four screws from the illumination module into the reader. Tighten each screw to 0.75 Nm.

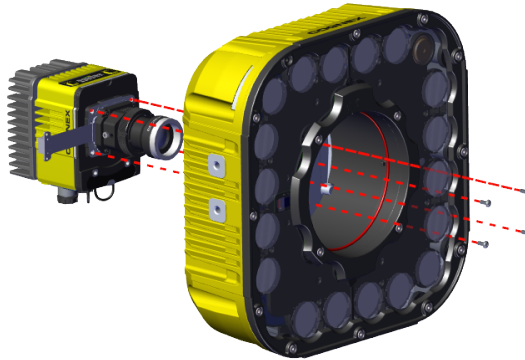

5. Snap the cable into place in the illumination module.
6. Align the slots in the cover with the illumination module. Twist slightly to lock the cover in.

Note: You can remove the lens cover at any time by twisting in the opposite direction. Removing the lens cover allows for access to the lens or installing a new lens without disassembling the HPIT.

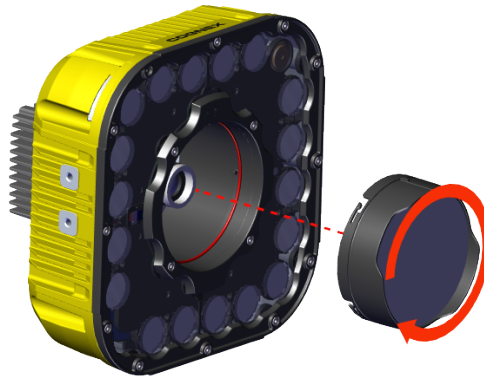

Change Manual Lens to Liquid Lens

1. Remove the manual lens.



2. Insert the High Speed Liquid Lens.



3. Tighten the captive screws on the High Speed Liquid Lens.

Add a Lens Cover

Lens Cover Compatibility

Lens cover	Compatible lenses
45 mm Plastic Lens Cover	16 mm f6.5 Cognex High-Resolution
	25 mm f6.5 Cognex High-Resolution
	35 mm f6.5 Cognex High-Resolution
60 mm Plastic Lens Cover	16 mm f6.5 Cognex High-speed Liquid Lens for High-Resolution
	25 mm f6.5 Cognex High-speed Liquid Lens for High-Resolution
	35 mm f6 Cognex High-speed Liquid Lens for High-Resolution
	35 mm Variable Aperture Moritex SR Series
	50 mm Variable Aperture Moritex SR Series
75 mm Plastic Lens Cover	12 mm Variable Aperture Moritex SR Series
	Note: The cover causes a slight cropping on a 16 MP sensor.
	16 mm Variable Aperture Moritex SR Series
	25 mm Variable Aperture Moritex SR Series

For the product numbers, see [Lenses on page 9](#).

Installing a Lens Cover

The following instructions depict a Cognex high speed liquid lens with a 60 mm plastic lens cover, but are applicable for all lens and lens cover combinations.

1. Place the bayonet onto the reader.



2. Screw in the four screws into the reader.



3. Push the lens cover onto the bayonet mount.



4. Rotate the lens cover into the bayonet mount.



Mounting the Reader

The reader provides mounting holes for attachment to a mounting surface.

CAUTION: The reader has to be grounded, either by mounting the reader to a fixture that is electrically grounded or by attaching a wire from the mounting fixture of the reader to frame ground or Earth ground. If a ground wire is used, it has to be attached to one of the mounting points on the bottom plate of the reader and not to the mounting points on the front of the reader.

Note: The mounting kits do not include nuts for attaching the bracket to the frame.

Mounting with Pivot Bracket

1. Align the pivot mounting bracket with the reader.

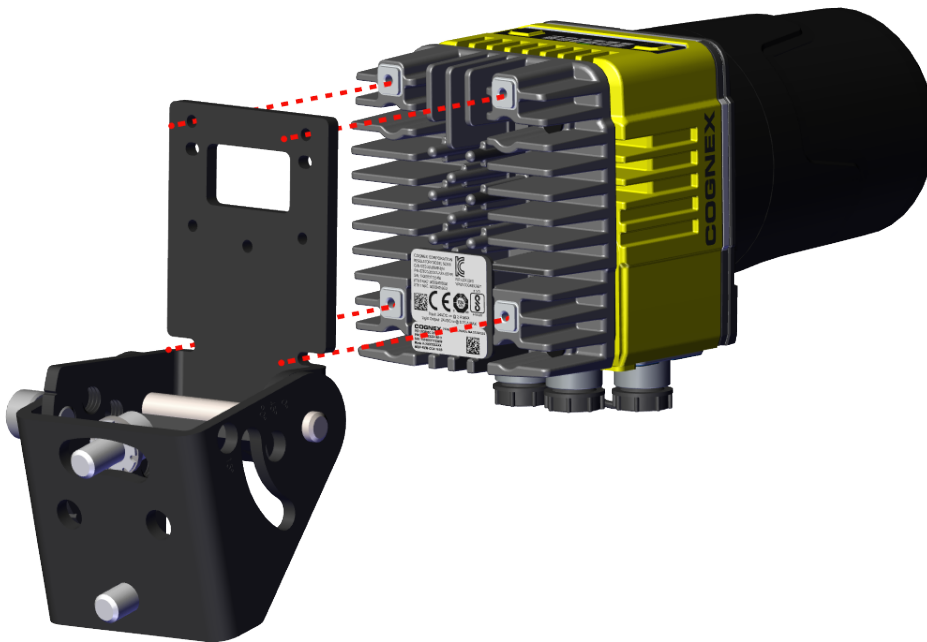

2. Insert the screws into the mounting pilot holes and tighten them.

i Note: Apply a maximum of 0.4 Nm torque when tightening the screws.

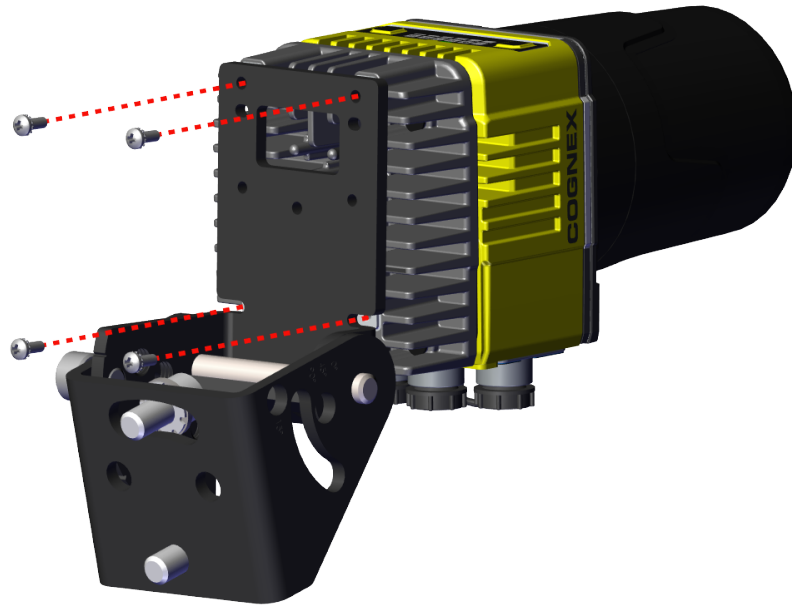

3. Place the reader on a mounting surface and tighten the screws.

Mounting with U-shaped Bracket for HPIT

1. Attach the pivot bracket to the frame.

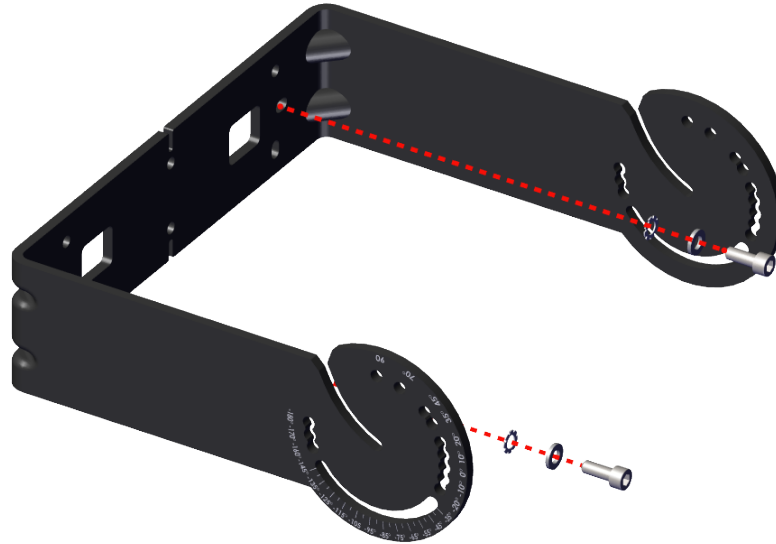

2. Insert the rotation axis screws without fully tightening them.

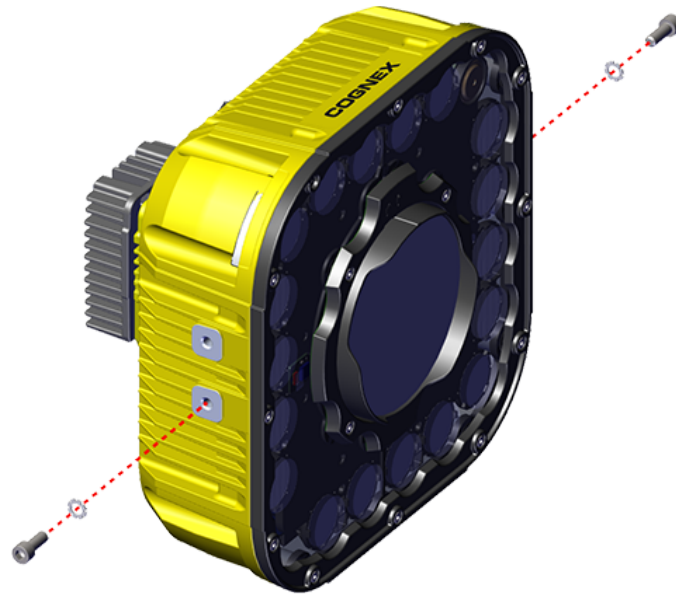

3. Slide the reader into the mounting bracket through the central slot.

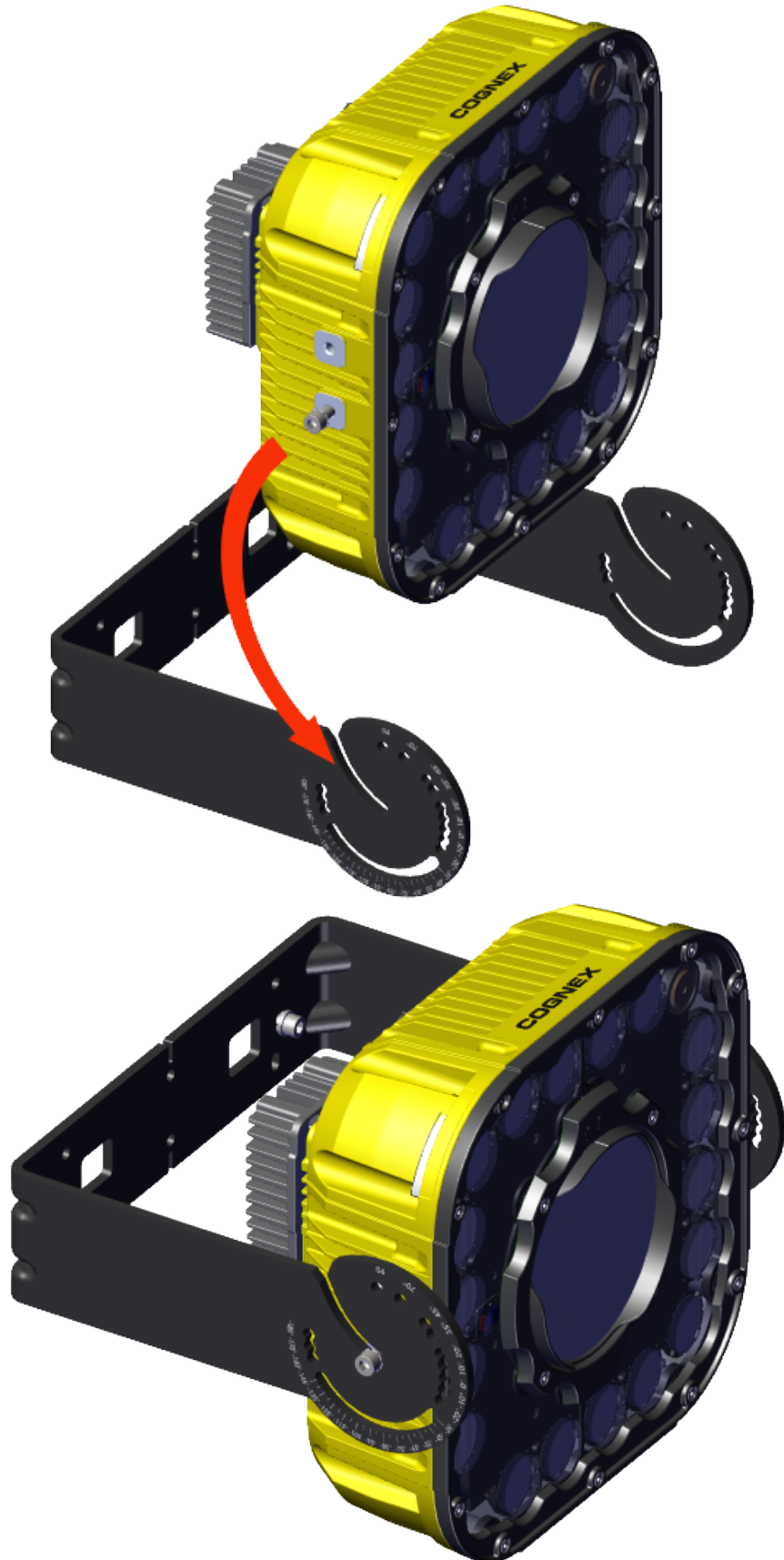

4. Apply the chosen rotation angle by inserting a screw into one of the preset holes or to the sliding slot on the mounting bracket.

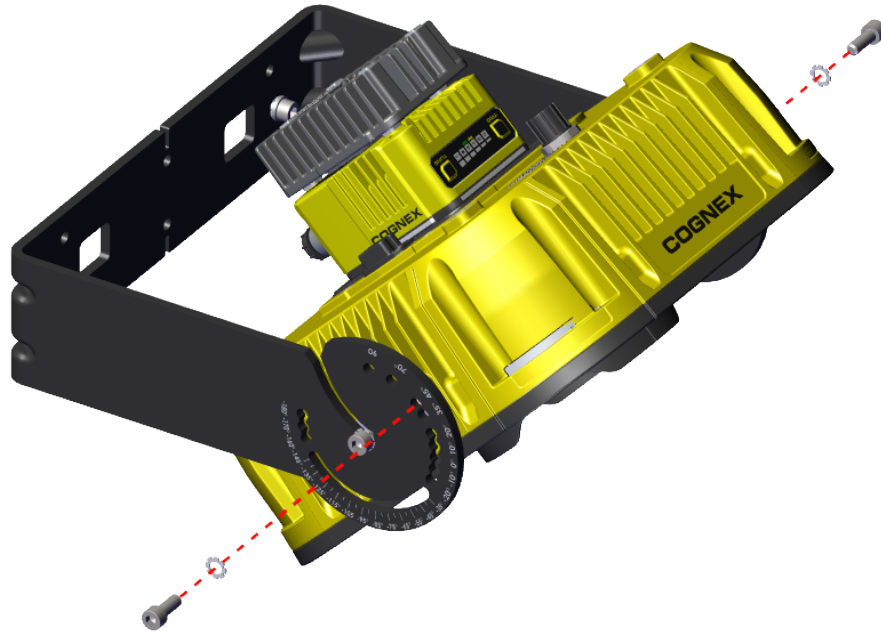

5. Tighten the mounting screws.

Note: Apply a maximum of 5 Nm torque when tightening the screws.

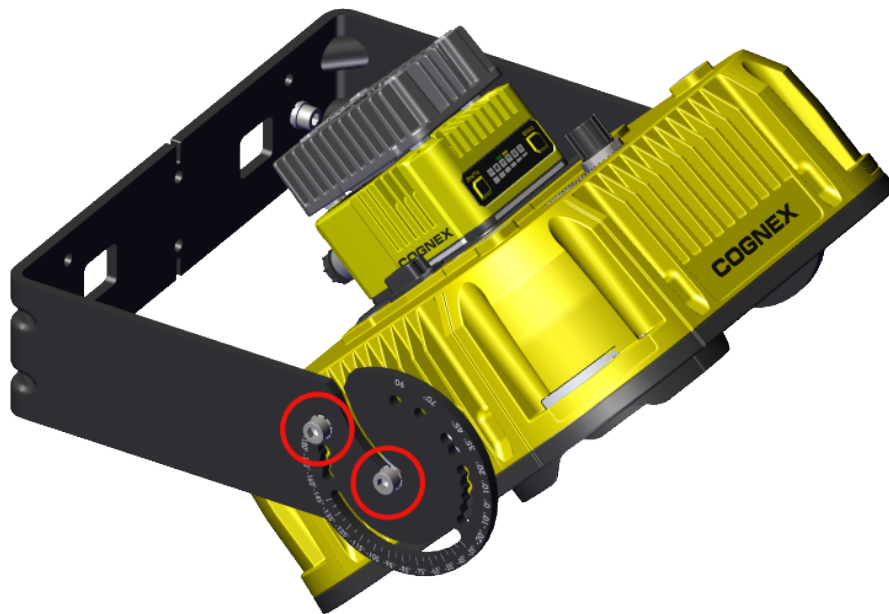

Connection Options

This section summarizes connection options.

For more information on how to connect your DataMan reader to your network, see the *DataMan Communications and Programming Guide*.

Connecting the Ethernet Cable

CAUTION: The Ethernet cable shield has to be grounded at the far end. Whatever this cable is plugged into (typically a switch or router) should have a grounded Ethernet connector. A digital voltmeter has to be used to validate the grounding. If the far end device is not grounded, a ground wire should be added in compliance with local electrical codes.

1. Connect the M12 connector of the Ethernet cable to the green ENET0 connector of the reader. You can also use ENET1 for Ethernet communication with the limitation that Multi-Reader Sync and PTP are bound to ENET0.

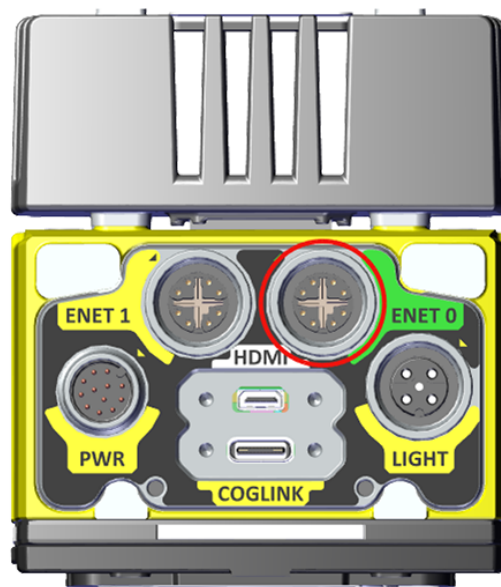

2. Connect the RJ-45 connector of the Ethernet cable to a switch, router, or PC.

Connecting the Power and I/O Breakout Cable

CAUTION: To reduce emissions, connect the far end of the Breakout cable shield to frame ground.

Note:



- Perform wiring or adjustments to I/O devices when the reader is not receiving power.
- You can clip unused wires short or use a tie made of non-conductive material to tie them back. Keep bare wires separated from the +24 V DC wire.

1. Verify that the 24 V DC power supply is unplugged and not receiving power.
2. Attach the +24 V DC connector of the Power and I/O Breakout cable and Ground wires to the corresponding terminals on the power supply. For more information, see [Specifications on page 45](#).
3. Attach the M12 connector of the Power and I/O Breakout Cable to the 24 V DC connector of the reader.
4. Restore power to the 24 V DC power supply and turn it on if necessary.

Powering the Integrated Illumination

You can power the integrated illumination either internally or externally.

Internal Power

Use the integrated illumination connector on the front of the reader.

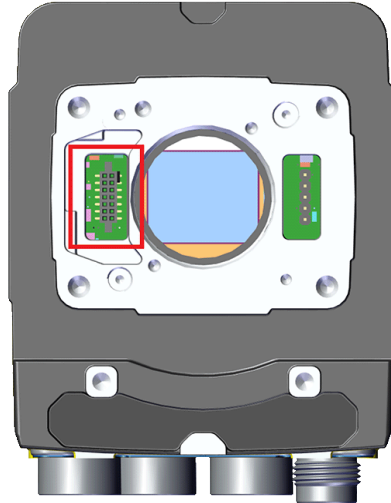

For more information on how to connect the illumination to the reader, see [Installing Manual Lens with HPIT on page 28](#) or [Installing High Speed Liquid Lens with HPIT on page 30](#).

External Power

Connect an external power supply to the external power connector on the back of the illumination.

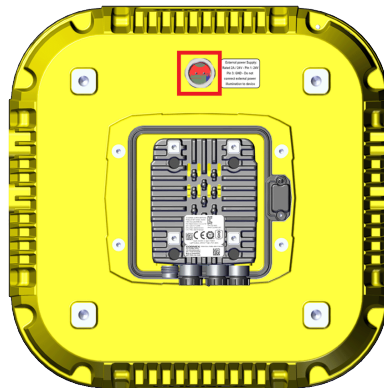

Observe the following measures when using external power for the illumination:

- Use a separate power supply rated for 24 V and 2 A.
- Connect the illumination to the front of the reader before powering on either the reader or external illumination

connector.

- Use a cable for connecting the illumination to the PSU with an M12 connector that conforms to the following pinout:

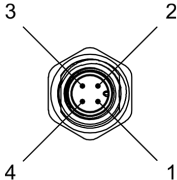

Pin Number	Signal
1	24 V
2	Not connected
3	GND
4	Not connected

CAUTION: Do not use the LIGHT connector to power the integrated light externally.

Using your Device through USB

You can use the USB connector of the DataMan 380 for emulating serial (USB-COM) functionality.

Emulating Serial Functionality

If you connect a USB-C cable, you can see a COM port in the Windows Device Manager, as a generic USB-COM port.

To emulate serial functionality:

1. Set the **USB Connection** properties in the **Serial** tab of the **Communication Settings** panel in DataMan Setup Tool.
2. Look at the Windows Device Manager to identify the proper device.
3. Enable the **Serial-over-USB** option in DataMan Setup Tool, because it is disabled by default.

Using Your DataMan Reader

This section provides information on the installation of the DataMan Setup Tool, trigger types, and protocols.

Installing the DataMan Setup Tool

Follow the steps below to install and connect your reader to the DataMan Setup Tool.

1. Check the DataMan **Release Notes** for a full list of system requirements.
2. Download the latest version of the DataMan Setup Tool from support.cognex.com/downloads/dataman/software-firmware and follow the on-screen steps.
3. Connect the 380 series reader to your PC.
4. Launch the DataMan Setup Tool and click **Refresh**. Detected devices appear under **COM ports** or **Network devices**, or both.
5. Select a reader from the list and click **Connect**.

Trigger Types

The DataMan 380 readers support the following trigger modes:

- **Self**: At a time interval you configure, the reader acquires an image and runs the job continuously.
- **Single** (external trigger): Acquires a single image and attempts to decode any symbol it contains, or more than one symbol in cases where multicode is enabled. The reader relies on an external trigger source.
- **Presentation**: Scans, decodes and reports a single code in the field of view. The reader relies on an internal timing mechanism to acquire images.
- **Manual**: Begins acquiring images when you press the trigger button on the reader, and continues acquiring images until a symbol is found and decoded or you release the button.
- **Burst** (external trigger): Performs multiple image acquisitions based on an external trigger and decodes any symbol appearing in a single image or within a sequence of images, or multiple symbols in a single image or within a sequence of images when multicode is enabled. You can control the number of images within each burst and the interval between image acquisitions.
- **Continuous** (external trigger): Begins acquiring images based on a single external trigger and continues to acquire and decode images until a symbol is found and decoded, or until multiple images containing as many codes as specified in multicode mode are located, or until the trigger is released. You can configure your reader to acquire images based on the start and stop signal from separate digital IO pulses.

External Triggers

If you are using external triggering, you can use any of the following methods to trigger your reader.

- Press the trigger button on the reader.

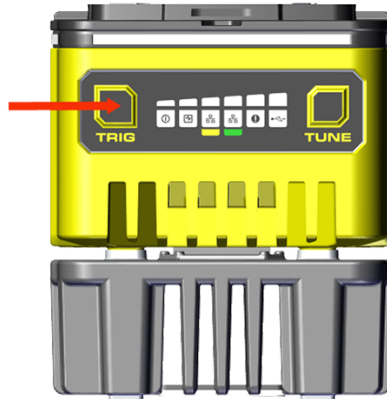

- Send a pulse on the I/O cable.
 - Trigger +
 - Trigger -
- Send a trigger command over any serial connection .
- Press **CTRL+T** on the keyboard while the DataMan Setup Tool has the input focus.
- Click the **Trigger** button in the DataMan Setup Tool.

i Note: You can also initiate external triggering through industrial protocols from a programmable logic controller.

Industrial Protocols

The reader supports the following industrial protocols:

- EtherNet/IP™, EDS and PLC
- PROFINET (Class B)
- SLMP Protocol

Specifications

The following sections list general specifications for the reader.

DataMan 380 Series Reader

Specification	DataMan 380
Lens Type	C-Mount lens or Cognex High Speed Liquid Lens
Trigger	1 opto-isolated, acquisition trigger input.
Discrete Inputs	1 opto-isolated, acquisition trigger input. Up to 3 general-purpose inputs when connected to the Breakout cable. $V_{IL}: \leq \pm 6\text{ V}$ $V_{IH}: \geq \pm 12\text{ V}$ $I_{TYP}: 4.2\text{ mA @ } 24\text{ V}$
Discrete Outputs	Up to 4 outputs when connected to the Breakout cable. $I_{MAX}: 50\text{ mA}$ $V_{OL}: \leq \pm 3\text{ V @ } 50\text{ mA}$
Status LEDs	Pass/Fail LED and Indicator Ring, Network LED, and Error LED.
Codes	1-D barcodes: Codabar, Code 39, Code 128, Code 93, Code 25, Interleaved 2 of 5, UPC/EAN/JAN 2-D barcodes: Data Matrix (ECC 0, 50, 80, 100, 140, and 200), QR Code, PDF 417, MaxiCode
Network Communication	2 Ethernet ports, 10/100/1000 BaseT with auto MDIX. IEEE 802.3 TCP/IP Protocol. Supports DHCP, static, and link-local IP address configuration. One port supports TSN networks. RS-232: Rx/D, Tx/D according to TIA/EIA-232-F
Power Consumption	24 V DC +/- 10% LPS or NEC class 2 Power consumption without USB device attached: <ul style="list-style-type: none"> • Average $\leq 15\text{ W}$ without illumination • Average $\leq 40\text{ W}$ with illumination • Peak $\leq 2\text{ A}$
Power Output	24 V DC at 1.0 A maximum to external light.
Material	Die-cast and extruded aluminum and zinc housing.
Finish	Painted.
Mounting	Four M3 threaded mounting holes. See Mounting Brackets on page 9 for supported mounts. Pattern: 38.5 × 58.5 mm (1.52 × 2.60 in)

Specification	DataMan 380
Weight	DataMan 380 with no accessories attached: 775 g (27.3 oz). <ul style="list-style-type: none"> with 45 mm plastic C-Mount cover (COV-380-CMNT-45): 830 g (29.3 oz) - no lens included. with 60 mm plastic C-Mount cover (COV-380-CMNT-60): 840 g (29.6 oz) - no lens included. with 75 mm plastic C-Mount cover (COV-380-CMNT-75): 855 g (30.1 oz) - no lens included. with Red HPIT Illumination: 3020 g (106.5 oz) - no lens included. with White HPIT Illumination: 3066 g (108.2 oz) - no lens included
Operational Temperature	0° C to 40° C (32° F to 122° F)
Storage Temperature	-20° C to 80° C (-4° F to 176° F)
Humidity	< 95% non-condensing
Protection	IP67, altitude: 2000 m, indoor use only, pollution degree II <div style="border: 1px solid black; padding: 5px; margin-top: 5px;"> <p>Note: IP67 rating applies only if all blind plugs and cables are attached properly, or the provided connector plug is installed. Also, make sure that the IP67-rated cover is installed properly.</p> </div>
Shock (Shipping and Storage)	IEC 60068-2-27 - 500 shocks in each polarity of each (X, Y, and Z) axis, 3000 shocks total, semi-sinusoidal, 11 g, 10 ms
Vibration (Shipping and Storage)	IEC 60068-2-6: vibration test in each of the three main axis for 2 hours at 10 Gs (10 to 500 Hz at 100 m/s ² / 15 mm) with cables or cable plugs and a 150 gram or lighter lens attached.
Regulations/Conformity	CE, FCC, KCC, TÜV SÜD NRTL, EU RoHS, China RoHS

DataMan 380 Series Reader Image Sensor

Specification	DM3808	DM3812	DM3816
Sensor Type	1/1.1-inch CMOS		1.1-inch CMOS
Image Sensor Properties	Diagonal size: 11.1 mm Pixel size: 2.74 µm (H) x 2.74 µm (V)	Diagonal size: 14 mm Pixel size: 2.74 µm (H) x 2.74 µm (V)	Diagonal size: 16.8 mm Pixel size: 2.74 µm (H) x 2.74 µm (V)
Maximum Image Resolution (pixels)	2840 x 2840 (8.06 mp)	4096 x 3000 (12.28 mp)	5320 x 3032 (16.13 mp)
Electronic Shutter Speed	Minimum exposure: 15 µs Maximum exposure: 200 ms		

LED Wavelengths

Model	LED	Wavelength
DataMan 380 with HPIT	Red	• 617 nm (AMBER)
	White	• Cx 0.321, Cy 0.327 acc. to CIE 1931 (WHITE)

Acquisition Trigger Input

The reader features one acquisition trigger input, which is optically isolated. You can configure the acquisition trigger input to trigger from an NPN (current sinking) or PNP (current sourcing) device.

- To trigger from an NPN type photoelectric sensor or PLC output, connect COMMON IN to +24 VDC and connect IN 0 to the output of the photoelectric sensor. When the output turns ON, it pulls TRIGGER down to 0 VDC, turning the opto-coupler ON.
- To trigger from a PNP photoelectric sensor or PLC output, connect IN 0 to the output of the photoelectric sensor and connect COMMON IN to 0 VDC. When the output turns ON, it pulls TRIGGER up to +24 VDC, turning the opto-coupler ON.

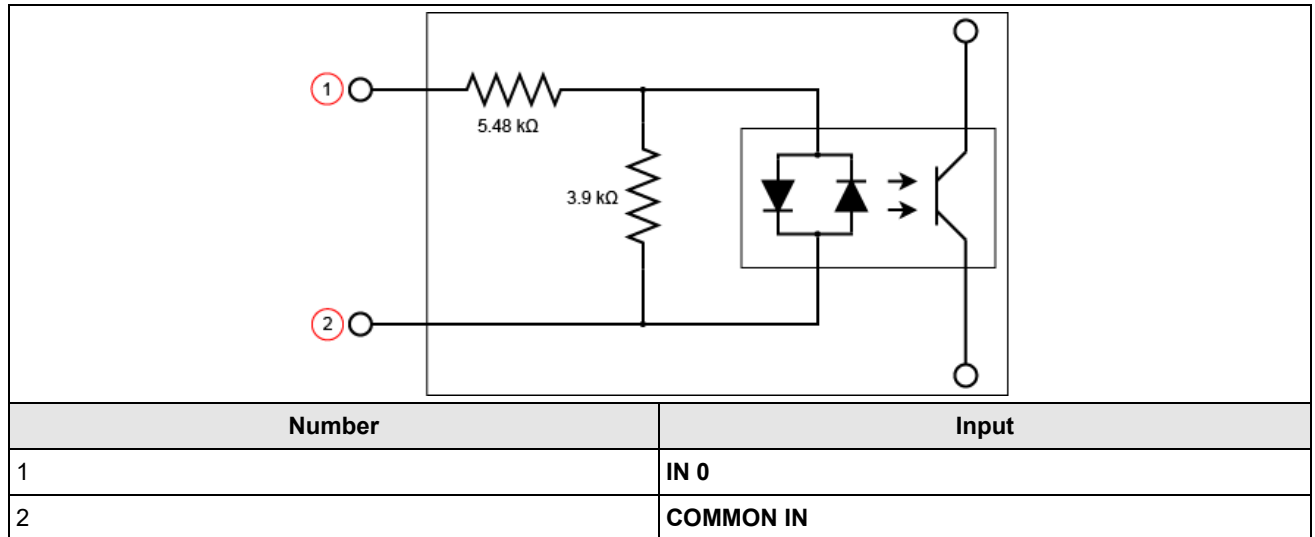

High-Speed Outputs

Specification	Description
Voltages	V_{MAX} : 26 VDC through external load V_{OL} : $\leq \pm 3$ V @ 50 mA
Current	I_{MAX} : 50 mA maximum sink or source current Each line is protected against over-current, short circuits and transients from switching inductive loads. High current inductive loads require an external protection diode.

For NPN lines, the external load should be connected between the output and the positive supply voltage (< 26 VDC). The output pulls down to less than 3 VDC when ON, which causes current to flow through the load. When the output is OFF, no current flows through the load.

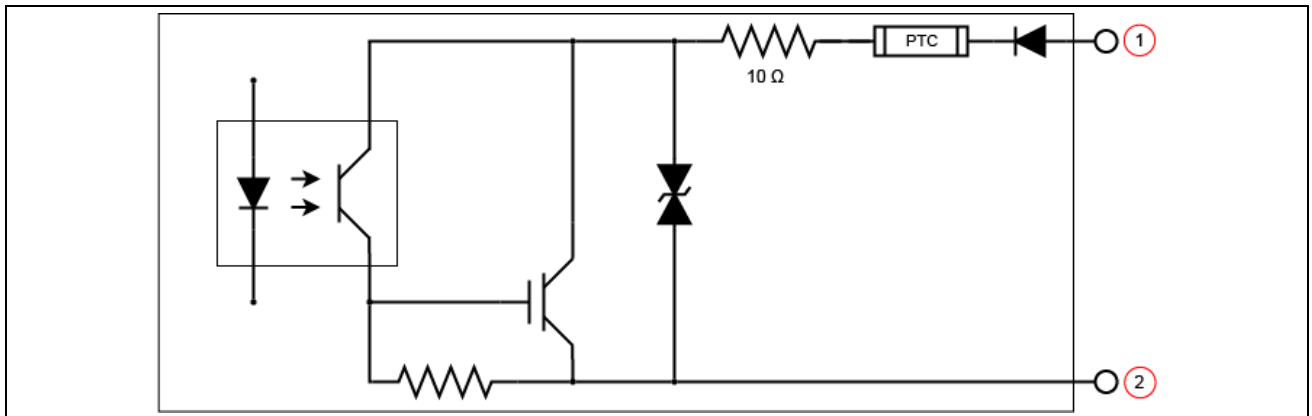

Number	Output
1	NPN OUT
2	COMMON OUT

For PNP lines, the external load should be connected between the output and the negative supply voltage (0 VDC). When connected to a 24 VDC power supply, the output pulls up greater than 21 VDC when ON, and current flows through the load. When the output is OFF, no current flows through the load.

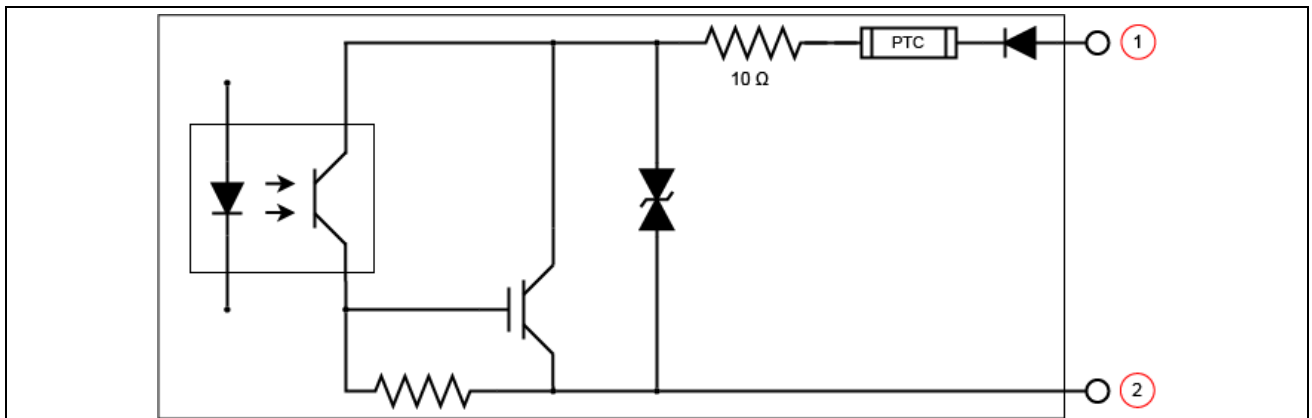

Number	Output
1	COMMON OUT
2	PNP OUT

Ethernet Cable

The Ethernet cable provides Ethernet connectivity to the reader. The Ethernet cable is used to connect the reader to other network devices.

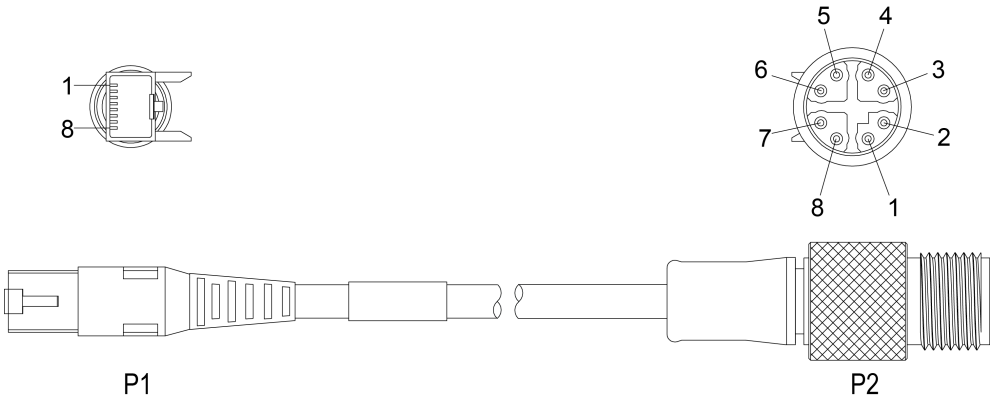

P1 Pin Number	Wire Color	Signal Name	P2 Pin Number
1	White/Orange	TxRx A +	1
2	Orange	TxRx A -	2
3	White/Green	TxRx B +	3
4	Blue	TxRx C +	8
5	White/Blue	TxRx C -	7
6	Green	TxRx B -	4
7	White/Brown	TxRx D +	5
8	Brown	TxRx D -	6

CAUTION: The Ethernet cable shield has to be grounded at the far end. Whatever this cable is plugged into (typically a switch or router) should have a grounded Ethernet connector. A digital voltmeter has to be used to validate the grounding. If the far end device is not grounded, a ground wire should be added in compliance with local electrical codes.

Note:

- Cables are sold separately.
- The wiring for this cable follows standard industrial Ethernet M12 specifications. It differs from the 568B standard.

Breakout Cable

The Breakout cable provides connections to an external power supply, the acquisition trigger input, encoder inputs (9902L only), general-purpose inputs, high-speed outputs, and RS-232 serial communications. The Breakout cable is not terminated.

The Breakout cable can be connected to devices, such as a trigger sensor or strobe light. The Breakout cable is not terminated.

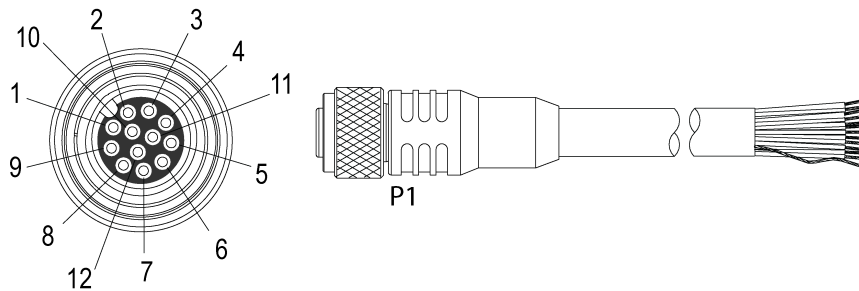

Pin#	Signal Names	Wire Color
1	IN 2 / HSOUT 2	Yellow
2	RS-232 TRANSMIT	White/Yellow
3	RS-232 RECEIVE	Brown
4	IN 3 / HSOUT 3	White/Brown
5	IN 1	Violet
6	COMMON IN	White/Violet
7	+24VDC	Red
8	GND	Black
9	COMMON OUT	Green
10	TRIGGER	Orange
11	HSOUT 0	Blue
12	HSOUT 1	Grey

Note:

- Cables are sold separately.
- Perform wiring or adjustments to I/O devices when the reader is not receiving power.
- You can cut exposed wires short or trim wire ends. You also can tie the wires back if you use a tie made of non-conductive material. Keep bare wires separated from the +24 V DC wire.
- When using the 15 meter Breakout cable, full 24VDC voltage must be maintained at the input leads of the Breakout cable when the vision system is operating.

External Light Connector

The LIGHT connector of the reader is used to connect the External Light cable to an external lighting device, providing power and strobe control. You can connect the External Light cable to either a continuous or strobed lighting device. Before using an external lighting device, you must configure the light settings within DataMan Setup Tool.

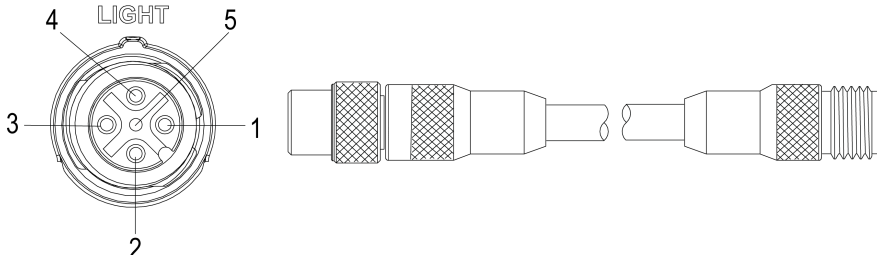

Pin#	Signal Name	Wire Color
1	+24 V DC	Brown
2	Intensity Control	White
3	GND	Blue
4	Strobe	Black
5	Chassis	Not Connected

Note:

- Cables are sold separately.
- Current load: 750 mA maximum. Only the +24 V DC pin is capable of sourcing 750 mA.
- Intensity Control is an analog signal that ranges from 0 to +10 V DC, and is configurable within DataMan Setup Tool. It is a control signal only, and must not be used to power an external device. Power must be sourced from +24 V DC and GND. Verify the External Light cable and light support intensity control.
- The Strobe output is active low 0 V DC and active high +12 V DC, with the Polarity configurable within DataMan Setup Tool. It is a control signal only and cannot be used for power. Power must be sourced from +24 V DC and GND.

CAUTION: Do not use the LIGHT connector to power the integrated light externally.

CCB-M12x12Fy-xx

The Power and I/O Breakout cable provides access to trigger and high-speed outputs. For RS-232, use the Power Supply return path for ground.

The figure on the left shows the plug on the device.

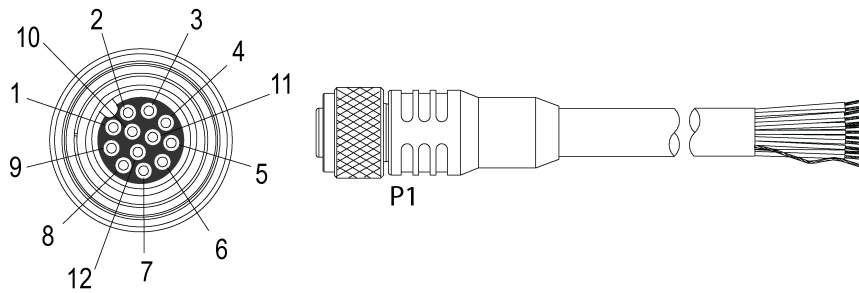

Pin#	Signal Names	Wire Color
1	Out 2/In 2	White
2	TxD	Green
3	RxD	Pink
4	Out 3/In 3	Yellow
5	In 1	Grey
6	Common In	Black
7	+24 VDC	Brown
8	GND	Blue
9	Common Out	Purple
10	In 0	Red
11	Out 0	Grey/Pink
12	Out 1	Red/Blue

Note:

- Cables are sold separately.



- Perform wiring or adjustments to I/O devices when the reader is not receiving power.
- You can cut exposed wires short or trim wire ends. You also can tie the wires back if you use a tie made of non-conductive material. Keep bare wires separated from the +24 V DC wire.

CCBL-05-01

The Power and I/O Breakout cable provides access to trigger and high-speed outputs. For RS-232, use the Power Supply return path for ground.

The figure on the left shows the plug on the device.

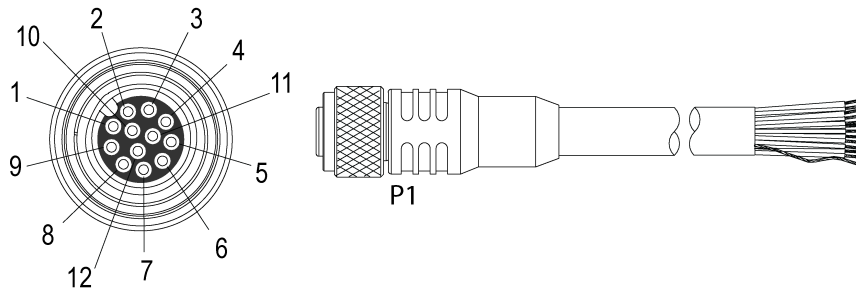

Pin#	Signal Names	Wire Color
1	Out 2/In 2	Yellow
2	TxD	White/Yellow
3	RxD	Brown
4	Out 3/In 3	White/Brown
5	In 1	Violet
6	Common In	White/Violet
7	+24 VDC	Red
8	GND	Black
9	Common Out	Green
10	In 0	Orange
11	Out 0	Blue
12	Out 1	Grey

Note:

- Cables are sold separately.
- i**
- Perform wiring or adjustments to I/O devices when the reader is not receiving power.
 - You can cut exposed wires short or trim wire ends. You also can tie the wires back if you use a tie made of non-conductive material. Keep bare wires separated from the +24 V DC wire.

CCB-PWRIO-05

The Power and I/O Breakout cable provides access to trigger and high-speed outputs. For RS-232, use the Power Supply return path for ground.

The figure on the left shows the plug on the device.

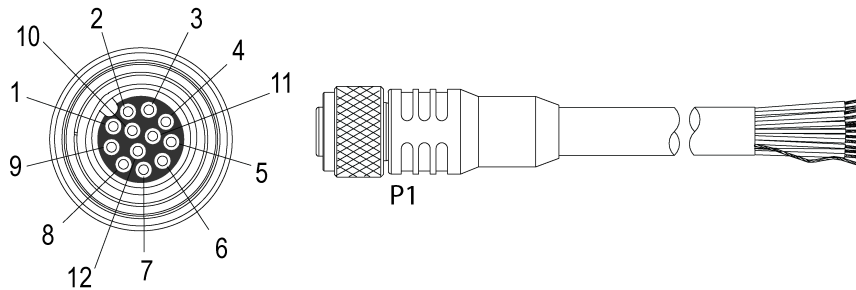

Pin#	Signal Names	Wire Color
1	Out 2/In 2	Yellow
2	TxD	White/Yellow
3	RxD	Brown
4	Out 3/In 3	White/Brown
5	In 1	Violet
6	Common In	White/Violet
7	+24 VDC	Red
8	GND	Black
9	Common Out	Green
10	In 0	Orange
11	Out 0	Blue
12	Out 1	Grey

Note:

- Cables are sold separately.
- i**
- Perform wiring or adjustments to I/O devices when the reader is not receiving power.
 - You can cut exposed wires short or trim wire ends. You also can tie the wires back if you use a tie made of non-conductive material. Keep bare wires separated from the +24 V DC wire.

Cleaning and Maintenance

Clean the Housing

To clean the outside of the reader housing, use a small amount of mild detergent cleaner or isopropyl alcohol on a cleaning cloth. Do not pour the cleaner on the reader housing.

 **CAUTION:** Do not attempt to clean any DataMan product with harsh or corrosive solvents, including lye, methyl ethyl ketone (MEK) or gasoline.

Clean the Reader Image Sensor Window

To remove dust from the outside of the image sensor window, use a pressurized air duster. The air must be free of oil, moisture or other contaminants that could remain on the glass and possibly degrade the image. Do not touch the glass window. If oil or smudges remain, use a cotton bud and alcohol (ethyl, methyl, or isopropyl) to clean the window. Do not pour the alcohol on the window.



Clean the Reader Lens Cover

To remove dust from the lens cover, use a pressurized air duster. The air must be free of oil, moisture or other contaminants that could remain on the lens cover. To clean the plastic window of the lens cover, use a small amount of isopropyl alcohol on a cleaning cloth. Do not scratch the plastic window. Do not pour the alcohol on the plastic window.

Regulations and Conformity

Note: For the most current CE and UKCA declaration and regulatory conformity information, see the Cognex support site: cognex.com/support.

DataMan 380 readers have Regulatory Model number 50103 and meet or exceed the requirements of all applicable standards organizations for safe operation. However, as with any electrical equipment, the best way to ensure safe operation is to operate them according to the agency guidelines that follow. Please read these guidelines carefully before using your device.

Safety and Regulatory	
Manufacturer	Cognex Corporation One Vision Drive Natick, MA 01760 USA
	DataMan 380 8 MP, 12 MP, 16 MP: Regulatory Model 50103 This is a class A product. In a domestic environment this product may cause radio interference in which case the user may be required to take immediate measures. This equipment complies with the essential requirements of the EU Directive 2014/30/EU. Declarations are available from your local representative.
EU RoHS	Compliant to the most recent applicable directive.
FCC	FCC Part 15, Class A This equipment has been tested and found to comply with the limits for a Class A digital device, pursuant to part 15 of the FCC Rules. These limits are designed to provide reasonable protection against harmful interference when the equipment is operated in a commercial environment. This equipment generates, uses, and can radiate radio frequency energy and, if not installed and used in accordance with the instruction manual, may cause harmful interference to radio communications. Operation of this equipment in a residential area is likely to cause harmful interference in which case the user will be required to correct the interference at his own expense.
Korea 	This device is certified for office use only and if used at home, there can be frequency interference problems. A급 기기(업무용 방송통신기자재): 이 기기는 업무용(A급) 전자파적합기기로서 판매자 또는 사용자는 이 점을 주의하시기 바라며, 가정외의 지역에서 사용하는 것을 목적으로 합니다. DataMan 380 8 MP, 12 MP, 16 MP: R-R-CGX-50103
TÜV	DataMan 380 8 MP, 12 MP, 16 MP: Regulatory Model 50103 NRTL: TÜV SÜD SCC/NRTL OSHA Scheme for UL/CAN 61010-1. CB report available upon request. TÜV SÜD, IEC/EN 61010-1.
	DataMan 380 8 MP, 12 MP, 16 MP: Regulatory Model 50103 This is a class A product. In a domestic environment this product may cause radio interference in which case the user may be required to take immediate measures. This equipment complies with the essential requirements of the Electromagnetic Compatibility Regulations 2016. Declarations are available from your local representative.

中国大陆RoHS (Information for China RoHS Compliance)

根据中国大陆《电子信息产品污染控制管理办法》(也称为中国大陆RoHS), 以下部份列出了本产品中可能包含的有毒有害物质或元素的名称和含量。



Hazardous Substances 有害物质						
Part Name 部件名称	Lead (Pb) 铅	Mercury (Hg) 汞	Cadmium (Cd) 镉	Hexavalent Chromium (Cr (VI)) 六价铬	Polybrominated biphenyls (PBB) 多溴联苯	Polybrominated diphenyl ethers (PBDE) 多溴二苯醚
Regulatory Model 50103	X	O	O	O	O	O

This table is prepared in accordance with the provisions of SJ/T 11364.

这个标签是根据SJ/T 11364 的规定准备的。

O: Indicates that said hazardous substance contained in all of the homogeneous materials for this part is below the limit requirement of GB / T26572 - 2011.

表示本部件所有均质材料中含有的有害物质低于GB / T26572 - 2011 的限量要求。

X: Indicates that said hazardous substance contained in at least one of the homogeneous materials used for this part is above the limit requirement of GB / T26572 - 2011.

表示用于本部件的至少一种均质材料中所含的危害物质超过GB / T26572 - 2011 的限制要求。

For European Community Users

Cognex complies with Directive 2012/19/EU OF THE EUROPEAN PARLIAMENT AND OF THE COUNCIL of 4 July 2012 on waste electrical and electronic equipment (WEEE).

This product has required the extraction and use of natural resources for its production. It may contain hazardous substances that could impact health and the environment, if not properly disposed.

In order to avoid the dissemination of those substances in our environment and to diminish the pressure on the natural resources, we encourage you to use the appropriate take-back systems for product disposal. Those systems will reuse or recycle most of the materials of the product you are disposing in a sound way.



The crossed out wheeled bin symbol informs you that the product should not be disposed of along with municipal waste and invites you to use the appropriate separate take-back systems for product disposal.

If you need more information on the collection, reuse, and recycling systems, please contact your local or regional waste administration.

You may also contact your supplier for more information on the environmental performance of this product.

