

COGNEX

MX-1000 User Guide

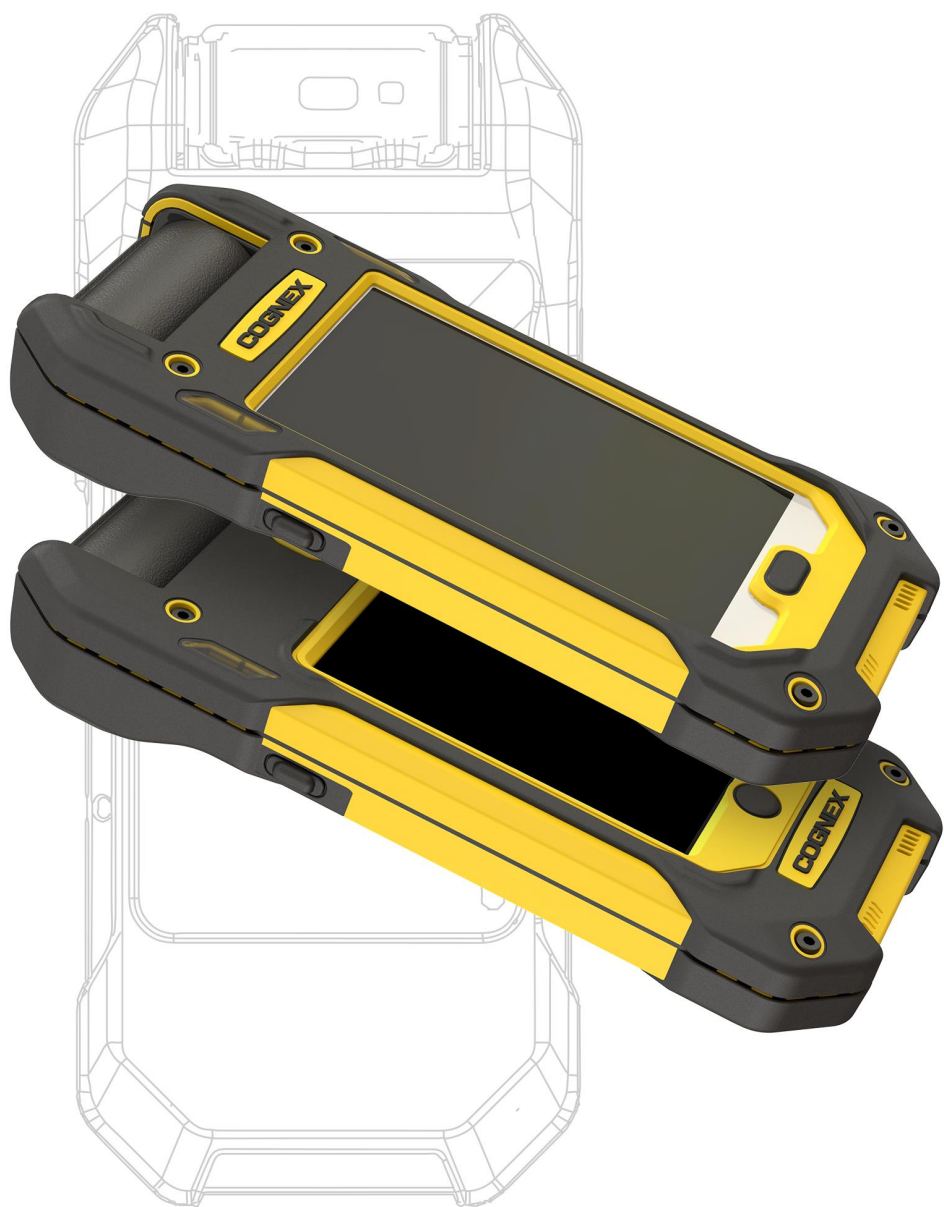

2022 November 23
Revision: 6.1.13SR4.1

Legal Notices

The software described in this document is furnished under license, and may be used or copied only in accordance with the terms of such license and with the inclusion of the copyright notice shown on this page. Neither the software, this document, nor any copies thereof may be provided to, or otherwise made available to, anyone other than the licensee. Title to, and ownership of, this software remains with Cognex Corporation or its licensor. Cognex Corporation assumes no responsibility for the use or reliability of its software on equipment that is not supplied by Cognex Corporation. Cognex Corporation makes no warranties, either express or implied, regarding the described software, its merchantability, non-infringement or its fitness for any particular purpose.

The information in this document is subject to change without notice and should not be construed as a commitment by Cognex Corporation. Cognex Corporation is not responsible for any errors that may be present in either this document or the associated software.

Companies, names, and data used in examples herein are fictitious unless otherwise noted. No part of this document may be reproduced or transmitted in any form or by any means, electronic or mechanical, for any purpose, nor transferred to any other media or language without the written permission of Cognex Corporation.

Copyright © 2021. Cognex Corporation. All Rights Reserved.

Portions of the hardware and software provided by Cognex may be covered by one or more U.S. and foreign patents, as well as pending U.S. and foreign patents listed on the Cognex web site at: cognex.com/patents.

The following are registered trademarks of Cognex Corporation:

Cognex, 2DMAX, Advantage, AlignPlus, Assemblyplus, Check it with Checker, Checker, Cognex Vision for Industry, Cognex VSOC, CVL, DataMan, DisplayInspect, DVT, EasyBuilder, Hotbars, IDMax, In-Sight, Laser Killer, MVS-8000, OmniView, PatFind, PatFlex, PatInspect, PatMax, PatQuick, SensorView, SmartView, SmartAdvisor, SmartLearn, UltraLight, Vision Solutions, VisionPro, VisionView

The following are trademarks of Cognex Corporation:

The Cognex logo, 1DMax, 3D-Locate, 3DMax, BGAll, CheckPoint, Cognex VSoC, CVC-1000, FFD, iLearn, In-Sight (design insignia with cross-hairs), In-Sight 2000, InspectEdge, Inspection Designer, MVS, NotchMax, OCRMax, PatMax RedLine, ProofRead, SmartSync, ProfilePlus, SmartDisplay, SmartSystem, SMD4, VisiFlex, Xpand

Portions copyright © Microsoft Corporation. All rights reserved.

Portions copyright © MadCap Software, Inc. All rights reserved.

Other product and company trademarks identified herein are the trademarks of their respective owners.

Table of Contents

Legal Notices	2
Table of Contents	3
Symbols	4
About MX-1000	5
Initial Setup	6
Tricks and Tips	8
The DataMan Quick Setup	9
Firmware Upgrade with DataMan Quick Setup	13
System Setup	14
Installing the DataMan Setup Tool	14
Proxy Mode	15
Keyboard Mode for iOS	15
Keyboard Mode for Android	16
Power Off Mode	17
MX-1000 Battery Management	18
Battery management	18
During charging	18
Battery management during use	18
Battery level indication	19
Troubleshooting	20
Compliance Statements	22
Compliance Statements: Wireless Charging Station	23
Precautions	25

Symbols

The following symbols indicate safety precautions and supplemental information:

 **WARNING:** This symbol indicates a hazard that could cause death, serious personal injury or electrical shock.

 **CAUTION:** This symbol indicates a hazard that could result in property damage.

 **Note:** This symbol indicates additional information about a subject.

 **Tip:** This symbol indicates suggestions and shortcuts that might not otherwise be apparent.

About MX-1000



The Cognex MX-1000 reader is a handheld ID mobile device supporting an integrated user interface based on a consumer mobile device in an industrial grade housing. It features high-speed bar code reading performance in a modular, rugged design that supports a variety of 3rd party mobile devices. The MX-1000 reader provides the industry's most advanced technology for reading 1-D and 2-D codes. The MX-1000 also reads challenging 2-D DPM codes. It is designed to withstand heavy use in industrial settings. The enhanced interface allows you to write and implement your own application according to the needs of your work environment.

Initial Setup

Perform the steps below to get your MX-1000 system up and running quickly and scan barcodes.

1. Assemble your MX-1000.



 **Tip:** For details, consult the ***MX-1000 Reference Manual***.



- i. Make sure that there is a battery in the MX-1000 device.
- ii. Make sure that the mobile device is powered on.

 **Note:** On some Android devices, the USB device class is not set by default, which hinders communication with the MX-1000. Please make sure that either MTP or PTP is selected on your mobile device when connected to a USB host.

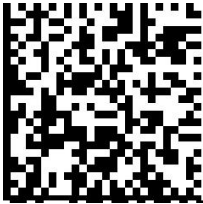
- iii. Ensure that the MX-1000 engine is turned on by pressing either of the trigger buttons (left or right side).

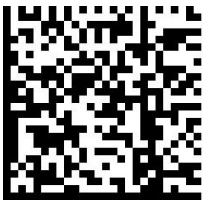
2. Scan the necessary Reader Programming (RP) codes from the following list:

	<p>USB Mode (Android)</p>	
	<p>USB Mode (iOS)</p>	
	<p>Enable Android Keyboard Emulation</p>	

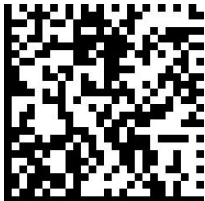
	Disable Android Keyboard Emulation	
	Enable iOS Keyboard Emulation	
	Disable iOS Keyboard Emulation	

3. Install the [DataMan Quick Setup](#) for the mobile platform you are using.
 - i. For Android: Install it from the Google Play Store.
 - ii. For iOS: Install it from the App Store.

 **Tip:** If you get a permissions error, go to Settings and select “Allow apps from unknown sources”. Then the installation will be successful.

4. Mobile Device Settings:
Settings on the mobile device that you may want to adjust to suit your application requirements:
 - Disable auto-rotate screen
 - Disable automatic screen brightness
 - Adjust screen timeout to maximum
 - Change touch key light duration to **Always On**
 - Enable increase touch sensitivity
 - Disable vibration in the phone (the MX-1000 has a vibration motor)
5. Start scanning: Open the DataMan Quick Setup on the mobile device and scan barcodes.

Tricks and Tips

1. A battery must be inserted in the back of the MX-1000 device for the scan engine to boot up. The scan engine does not run off the phone's battery. Rather, the Cognex battery powers the Cognex scan engine and provides auxiliary power to the phone.
2. Power the phone on separately, using the power button.
3. There is a left and right trigger button on the reader, and a software trigger button in the DataMan Quick Setup.
4. To reboot the reader, you do not have to remove the batteries. Just keep both side buttons pressed for ten seconds. After 5 seconds, you will see green light, then orange, then red and then the reader reboots.
5. To temporarily restore the default settings until the next reboot, follow the steps below.
 - i. Reboot the reader as described above.
 - ii. Follow the sequence as described in the table below:

User Action	Reader LED Sequence	Audio Indication	Description
1. Press and hold any trigger button.	Green	N/A	The reader is rebooting.
2. Hold the trigger button pressed.	Blinking red-green	N/A	After holding the trigger button pressed for a while, the Indicator LEDs switch to blinking red-green.
3. Release the trigger button.	Green	Beep	The beep and the Indicator LED turning green indicate that the trigger button can be released.
4. N/A	Orange	N/A	N/A
5. Press and hold the trigger button.	Green	Beep	The beep and the Indicator LED turning green indicate the trigger button must be pressed and held again.
6. Release the trigger button.	Green	Three beeps	The process was successful.

The DataMan Quick Setup

The **DataMan Quick Setup** can be used to configure your reader through your mobile device. By using this application, you can see the image and the decoded barcode software, change some basic settings on the DataMan device and update the firmware.

The first step in the MX-1000 setup process is to download and start the DataMan Quick Setup on your mobile phone.

Note: For information on how to install the DataMan Quick Setup, see the section on [Initial Testing](#).

Tip: You can download the DataMan Quick Setup from the Google Play store.

1. To start the DataMan Quick Setup, tap the DataMan Quick Setup icon on the desktop of your mobile user interface. The **Camera** page of the DataMan Quick Setup appears.

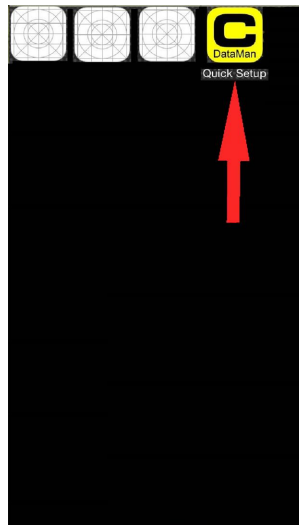

2. If you keep tapping **Trigger** or keep pressing the trigger buttons on your reader or on the grip, your reader scans and reads a code.

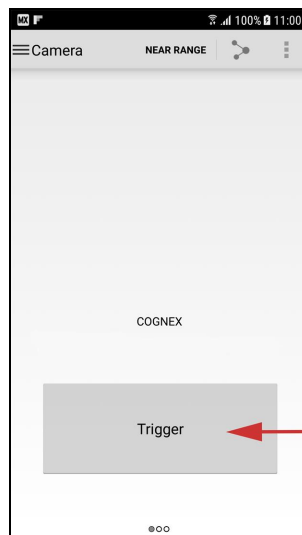

5. On swiping again, you can configure the details of the illumination and the aimer.

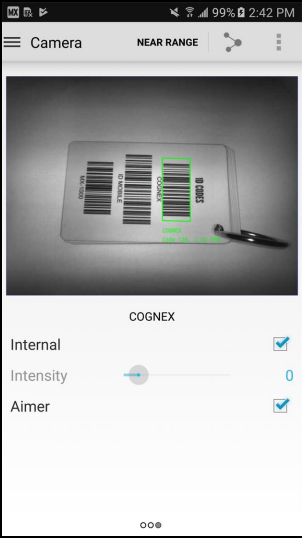

6. The functions can be reached from the main menu. On the **Result History** page, you find details about your past activities with the DataMan Quick Setup.

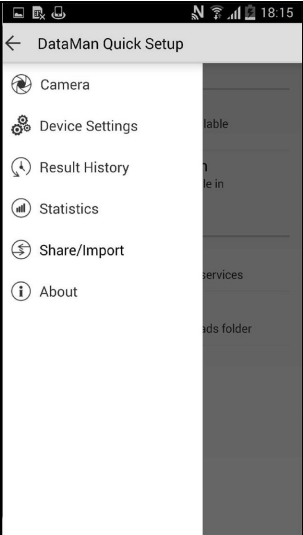

DataMan Quick Setup - Main Menu



Check the logs on the **Result History** page.

7. On the **Device Settings** page, you can configure the trigger type and the code symbologies.

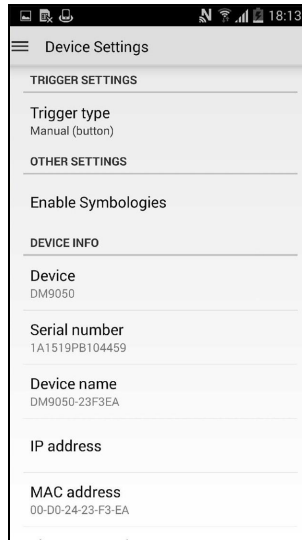

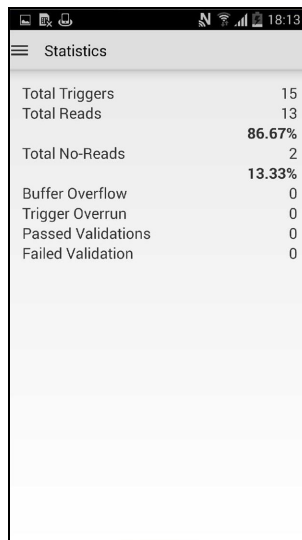

8. The **Statistics** page provides data on the triggers and reads.



You can perform the steps above not only by using the MX-1000 reader but also by using readers connected to your device on a network.



 **Tip:** If you want to develop your own application instead of using the DataMan Quick Setup, use the *Mobile SDK* available at <http://cognex.com>.

 **Note:** You can also perform the reader configuration in the [proxy mode](#) of the DataMan Quick Setup by using the [DataMan Setup Tool](#).

Firmware Upgrade with DataMan Quick Setup

To upgrade the firmware on your MX-1000 via the DataMan Quick Setup, follow the steps below:

 **Tip:** Firmware can be upgraded via the [DataMan Setup Tool](#) as well.

1. Make sure that your mobile device is connected properly to the MX-1000 and that you have performed [Initial Testing](#).
2. Navigate to the **Device Settings** page and tap **Firmware update**.
3. Tap on the firmware version you want to update to.
4. Tap **Download & Update**.

System Setup

Some settings can be adjusted using the DataMan Quick Setup. However, you can access all the settings on the MX-1000 by using the latest DataMan Setup Tool.

1. Download the latest DataMan Setup Tool onto your PC from the following URL:
<http://www.cognex.com/support/mx-1000/>
2. Connect your mobile device to a WiFi network.
3. Open the DataMan Quick Setup on the mobile device.

Make sure that you can see images on the phone coming from the reader, and trigger and see barcodes: launch the DataMan Setup Tool on your PC and connect to the MX-1000 reader, which will then appear under **Network devices**.

Note: The MX-1000 engine must be awake. You can check this by making sure that you can connect in the DataMan Quick Setup or by pressing the trigger buttons.





While connected to the DataMan Setup Tool, you can enable/disable symbologies, adjust the hibernate and power off times of the engine, adjust any data formatting and program scripting and more.

Installing the DataMan Setup Tool

The MX-1000 can be configured not only from the **DataMan Quick Setup** running on a mobile device, but also through a WiFi network using the **DataMan Setup Tool** installed on your PC or laptop. This process is the **proxy mode** of the DataMan Quick Setup.

Perform the following steps to use the DataMan Setup Tool:

1. Check the **MX-1000 Release Notes** for a full list of system requirements.
2. Download the latest DataMan Setup Tool from <http://www.cognex.com/support/dataman> and follow the on-screen steps.
3. Connect to a WiFi network with your mobile phone used in your MX-1000 reader. The used WiFi network must be the same to which the PC or laptop of the running Setup Tool is connected.
4. Start the DataMan Quick Setup on your reader because the DataMan Quick Setup must be running while using the DataMan Setup Tool.
5. Start the DataMan Setup Tool on your PC or laptop. Select one or more MX-1000 readers you want to work with and click **Connect**.

	DM8050-1BF566	DM8050	10.86.80.77	5.4.3	Discovered
	DM8500-RtmLeanTest-OJ	DM8500	10.86.80.19	4.2.4	Discovered
	DM8600-1C1AAC	DM8600	10.86.80.2	5.4.3	Discovered
	MX-1000-246EE6	MX-1000	192.168.1.124	5.5.1	Discovered

6. Set up and configure the reader.

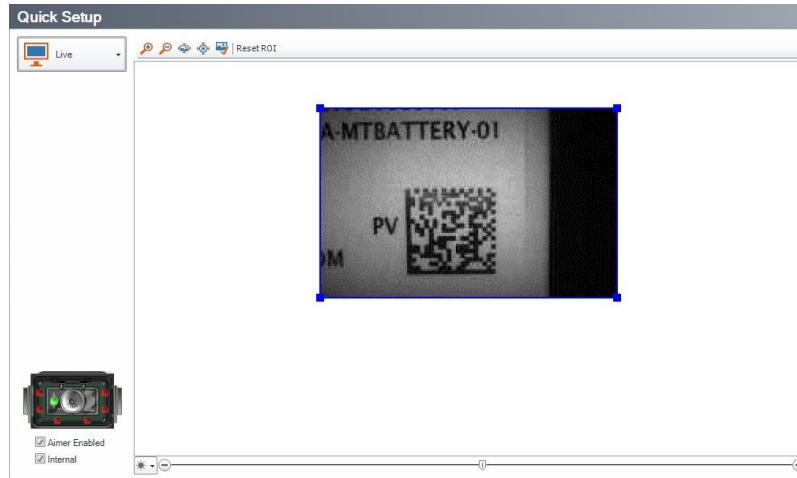

Tip: For more information on how to use the DataMan Setup Tool, consult the *DataMan Setup Tool Reference Manual*.

Proxy Mode

The DataMan Quick Setup provides the most important configuration features of readers. If you need more functions to get the appropriate reading result, use your reader in proxy mode via a WiFi network. In this case, your reader settings can be changed via the DataMan Setup Tool installed on a PC or laptop instead of using the DataMan Quick Setup directly.



Before you start using the DataMan Setup Tool to reach and control your reader in proxy mode, ensure that the following preconditions are met:

- Your mobile phone needs to connect to a network router.
- The PC or laptop on which you use the DataMan Setup Tool, and your mobile phone on which you use the DataMan Quick Setup must be on the same WiFi network.
- The DataMan Quick Setup must be running while you are using the DataMan Setup Tool.





Keyboard Mode for iOS

On iOS only, switch the MX-1000 reader keyboard mode on or off by scanning the following codes:

	Enable iOS Keyboard Mode	
	Disable iOS Keyboard Mode	

Keyboard Mode for Android

On Android only, switch the MX-1000 reader keyboard mode on or off by scanning the following codes:

	Enable Android Keyboard Mode	
	Disable Android Keyboard Mode	

Power Off Mode

The aim of **power off mode** is to extend battery life by minimizing the power consumption of the device.

The device can enter power off mode if the device is idle for extended time (1800 seconds by default). In power off mode, all parts of the system will be powered off except for the wireless charger. Resuming from power off mode can be done by pressing any of the device's buttons or by attaching to a charger. The power off feature cannot be synchronized with the power on status of the mobile device; they can be powered on or off independently.

Note: The power off feature is disabled while the device is being charged.

MX-1000 Battery Management

The battery management of the MX-1000 reader supports two types of optimization: **charging time optimization** and **runtime optimization**.

- **Charging time optimization** distributes available wireless charging power among the different batteries in the system to achieve the shortest charge time under the given conditions.
- The role of **runtime optimization** is to balance the discharging of the batteries of the device and the mobile device to achieve the longest potential system operation time with a single charge.

Note: Using or storing the device outside of the recommended temperature ranges may damage or reduce the battery's lifespan. Leaving the MX Series Mobile Terminal with a mobile device in direct sunlight for an extended amount of time can raise the temperature above the recommended limit.

Battery management

Improved battery management (available from firmware version 5.7.9 SR4) covers the following:

- how the MX-1000 charges the hosted device when the device is in its charging bay (or attached to a USB charger);
- and also how and when the MX-1000 provides power to the hosted device when the MX-1000 itself is not being charged.

During charging

The MX-1000 does not hold the hosted device's battery at full capacity for a long time. This process helps prolonging the hosted device's battery life.

- For the first 24 hours, the MX-1000 charges the hosted phone or iPod to its maximum capacity (100%), then stops charging.

If the hosted device's charge then drops below 90% charge, the MX-1000 provides power to charge the hosted device back to 100%.

- If the MX is still being charged after this initial 24-hour period, the MX-1000 allows the hosted device's battery to drop to 75%.

After letting the hosted device's battery drop to 75%, the MX-1000 starts to charge the hosted device's battery again, but it does not charge the battery above 85%.

Note: When you remove an MX-1000 from its charger, the hosted device's charge can be as low as 75%, depending on how long the MX-1000 had been charging the hosted device's battery. This is normal.

Note: As soon as you remove the MX from charging, charging periods reset. This means if you immediately put the MX-1000 back to charging, the MX-1000

Battery management during use

When in use, the MX-1000 only starts to charge the hosted device's battery if the battery's state of charge reaches 35%. The MX-1000 only recharges the hosted device's battery to a maximum of 70%.

Note: This is true only if the MX-1000 itself has over 750mAh of battery life left (about 25% when just using the flat pack battery, or about 13% when using both a flat pack and pistol grip battery). If the MX-1000's charge drops below this 750mAh threshold, the MX-1000 does not charge the phone.

Battery level indication

The red LED on the MX-1000 starts to blink at different intervals when the battery charge is low. Consult the table below to see what a certain blinking behavior indicates.

Blinking Intensity	Battery Capacity / Effect
per 2 seconds	9-5%
per second	4-3%
per 0.5 second	2-0%
per 500 ms	Power off

You can also check the battery status via the Quick Setup Application (see on the image below).



Troubleshooting

Symptom	Explanation	Solution
You have MX-1000s or DataMan reader(s) present on your wireless network and you are unable to connect to them from the DataMan Setup Tool or from the DataMan Quick Setup despite being on the same wireless network.	If you are using a wireless access point that is not supporting physical broadcast, you are not able to connect to your DataMan readers.	Use a network element that does support physical broadcast. For example, put a router behind your wireless access point.
The MX-1000 does not connect to your Android device in USB mode.	On some Android devices, the USB device class is not set by default, which hinders communication with the MX-1000.	Make sure that either MTP or PTP is selected on your mobile device when connected to a USB host.
The Quick Setup application shows the message: "MX-1000 is off. Please press trigger to wake up."	Connection between the reader and the application could not be established.	<ul style="list-style-type: none"> • Make sure that the reader is turned on. Press any button to power on. • Make sure that the cable between the phone and the reader is connected properly. • Restart the application. • Reboot the reader. To do this, hold both side buttons pressed for ten seconds.
The reader is producing two short green blinks repeatedly.	The reader is being internally reconfigured.	The process should not take more than a minute. Do not remove any batteries while the device is producing this light pattern. Removing the batteries during this process can permanently damage the device.
You are using the SDK but your application is not able to communicate with the reader.		<ul style="list-style-type: none"> • Make sure that the reader is turned on. Press any button to power on. • On Android, make sure that the keyboard mode is disabled. • Make sure that the cable between the phone and the reader is connected properly. • Restart the application. • Reboot the reader. To do this, hold both side buttons pressed for ten seconds.

Symptom	Explanation	Solution
After scanning a code, the reader beeps twice but no result is visible.	No application is connected to the reader.	Open the application you want to see the result in, and make sure it was able to connect to the reader. If using keyboard mode, make sure the cursor is in a text box where data can be typed in.
The reader does not respond to any button pressed.		<ul style="list-style-type: none"> • Put the reader on charger. • Hold both side buttons pressed for ten seconds to reboot the reader.



Compliance Statements

The MX-1000 has Regulatory Model 1AA7 (inductive) and Regulatory Model R00078 (non-inductive) , and meets or exceeds the requirements of all applicable standards organizations for safe operation. However, as with any electrical equipment, the best way to ensure safe operation is to operate them according to the agency guidelines that follow. Please read these guidelines carefully before using your device.

The following specifications apply to the MX-1000 readers:

Regulator	Specification
USA	FCC Part 15, Subpart B Class A
Canada	ICES-003, Class A
European Community	EN55022, Class A EN55024

Note: For the most current CE declaration and regulatory conformity information, see the Cognex support site: cognex.com/support.

Safety and Regulatory	
European Compliance 	This is a class A product. In a domestic environment this product may cause radio interference in which case the user may be required to take adequate measures. This equipment complies with the essential requirements of EU Directive 2014/30/EU. Declarations are available from your local representative.
FCC Class A Compliance Statement 	This equipment has been tested and found to comply with the limits for a Class A digital device, pursuant to part 15 of the FCC Rules. These limits are designed to provide reasonable protection against harmful interference when the equipment is operated in a commercial environment. This equipment generates, uses, and can radiate radio frequency energy and, if not installed and used in accordance with the instruction manual, may cause harmful interference to radio communications. Operation of this equipment in a residential area is likely to cause harmful interference in which case the user will be required to correct the interference at his own expense.
Canadian Compliance	This Class A digital apparatus complies with Canadian ICES-003. Cet appareil numérique de la classe A est conforme à la norme NMB-003 du Canada.
TÜV	MX-1000, inductive: Regulatory Model 1AA7 MX-1000, non-inductive: Regulatory Model R00078 NRTL: TÜV SÜD SCC/NRTL OSHA Scheme for UL/CAN 61010-1. CB report available upon request. TÜV SÜD, IEC/EN 61010-1.
Korea 	MX-1000: Regulatory Model 1AA7 (inductive), R00078 (non-inductive)

For European Union Users

Cognex complies with Directive 2012/19/EU OF THE EUROPEAN PARLIAMENT AND OF THE COUNCIL of 4 July 2012 on waste electrical and electronic equipment (WEEE).

This product has required the extraction and use of natural resources for its production. It may contain hazardous substances that could impact health and the environment, if not properly disposed.

In order to avoid the dissemination of those substances in our environment and to diminish the pressure on the natural resources, we encourage you to use the appropriate take-back systems for product disposal. Those systems will reuse or recycle most of the materials of the product you are disposing in a sound way.



The crossed out wheeled bin symbol informs you that the product should not be disposed of along with municipal waste and invites you to use the appropriate separate take-back systems for product disposal.

If you need more information on the collection, reuse, and recycling systems, please contact your local or regional waste administration.

You may also contact your supplier for more information on the environmental performance of this product.

Compliance Statements: Wireless Charging Station

The Wireless Charging Station has Regulatory Model 1ABA (inductive) and Regulatory Model R00080 (non-inductive), and meets or exceeds the requirements of all applicable standards organizations for safe operation. However, as with any electrical equipment, the best way to ensure safe operation is to operate them according to the agency guidelines that follow. Please read these guidelines carefully before using your device.

Regulator	Specification
USA	FCC 47 CFR Part 15, Subpart B Class A
Canada	ICES-003, Class A
European Community	EN55032, Class A EN55024
Australia	AS/NZS 3548 Class A
Japan	VCCI V-3/2015.04 Class A
Korea	IEC/CISPR 22 IEC/CISPR 24 KN22 KN24 Registration number: MSIP-REM-CGX-DMA-MT-BASE

For European Union Users

Cognex complies with Directive 2012/19/EU OF THE EUROPEAN PARLIAMENT AND OF THE COUNCIL of 4 July 2012 on waste electrical and electronic equipment (WEEE).

This product has required the extraction and use of natural resources for its production. It may contain hazardous substances that could impact health and the environment, if not properly disposed.



In order to avoid the dissemination of those substances in our environment and to diminish the pressure on the natural resources, we encourage you to use the appropriate take-back systems for product disposal. Those systems will reuse or recycle most of the materials of the product you are disposing in a sound way.



The crossed out wheeled bin symbol informs you that the product should not be disposed of along with municipal waste and invites you to use the appropriate separate take-back systems for product disposal.

If you need more information on the collection, reuse, and recycling systems, please contact your local or regional waste administration.

You may also contact your supplier for more information on the environmental performance of this product.

Safety and Regulatory	
European Compliance 	This is a Class A product. In a domestic environment this product may cause radio interference in which case the user may be required to take adequate measures. This equipment complies with the essential requirements of EU Directive 2014/30/EU. Declarations are available from your local representative.
FCC Class A Compliance Statement 	FCC Part 15, Class A This equipment has been tested and found to comply with the limits for a Class A digital device, pursuant to part 15 of the FCC Rules. These limits are designed to provide reasonable protection against harmful interference when the equipment is operated in a commercial environment. This equipment generates, uses, and can radiate radio frequency energy and, if not installed and used in accordance with the instruction manual, may cause harmful interference to radio communications. Operation of this equipment in a residential area is likely to cause harmful interference in which case the user will be required to correct the interference at his own expense.
Canadian Compliance	This Class A digital apparatus complies with Canadian ICES-003. Cet appareil numérique de la classe A est conforme à la norme NMB-003 du Canada.

Precautions

To reduce the risk of injury or equipment damage, observe the following precautions when you install the Cognex product:

- Route cables and wires away from high-current wiring or high-voltage power sources to reduce the risk of damage or malfunction from the following causes: over-voltage, line noise, electrostatic discharge (ESD), power surges, or other irregularities in the power supply.
- Changes or modifications not expressly approved by the party responsible for regulatory compliance could void the user's authority to operate the equipment.
- Ensure that the cable bend radius begins at least six inches from the connector. Cable shielding can be degraded or cables can be damaged or wear out faster if a service loop or bend radius is tighter than 10X the cable diameter.
- This device should be used in accordance with the instructions in this manual.
- All specifications are for reference purposes only and can change without notice.
- The safety of any system incorporating this product is the responsibility of the assembler of the system.
- This product is intended for industrial use in automated manufacturing or similar applications.
- This product does not contain user-serviceable parts. Do not make electrical or mechanical modifications to product components. Unauthorized modifications can void your warranty.

