

## DataMan<sup>®</sup> 80 Series Reference Manual



2024 April 24  
Revision: 24.2.0.12

# Legal Notices

The software described in this document is furnished under license, and may be used or copied only in accordance with the terms of such license and with the inclusion of the copyright notice shown on this page. Neither the software, this document, nor any copies thereof may be provided to, or otherwise made available to, anyone other than the licensee. Title to, and ownership of, this software remains with Cognex Corporation or its licensor. Cognex Corporation assumes no responsibility for the use or reliability of its software on equipment that is not supplied by Cognex Corporation. Cognex Corporation makes no warranties, either express or implied, regarding the described software, its merchantability, non-infringement or its fitness for any particular purpose.

The information in this document is subject to change without notice and should not be construed as a commitment by Cognex Corporation. Cognex Corporation is not responsible for any errors that may be present in either this document or the associated software.

Companies, names, and data used in examples herein are fictitious unless otherwise noted. No part of this document may be reproduced or transmitted in any form or by any means, electronic or mechanical, for any purpose, nor transferred to any other media or language without the written permission of Cognex Corporation.

Copyright © 2024. Cognex Corporation. All Rights Reserved.

Portions of the hardware and software provided by Cognex may be covered by one or more U.S. and foreign patents, as well as pending U.S. and foreign patents listed on the Cognex web site at: [cognex.com/patents](https://cognex.com/patents).

---

The following are registered trademarks of Cognex Corporation:

Cognex, 2DMAX, Advantage, AlignPlus, Assemblyplus, Check it with Checker, Checker, Cognex Vision for Industry, Cognex VSOC, CVL, DataMan, DisplayInspect, DVT, EasyBuilder, Hotbars, IDMax, In-Sight, Laser Killer, MVS-8000, OmniView, PatFind, PatFlex, PatInspect, PatMax, PatQuick, SensorView, SmartView, SmartAdvisor, SmartLearn, UltraLight, Vision Solutions, VisionPro, VisionView

The following are trademarks of Cognex Corporation:

The Cognex logo, 1DMax, 3D-Locate, 3DMax, BGAll, CheckPoint, Cognex VSoC, CVC-1000, FFD, iLearn, In-Sight (design insignia with cross-hairs), In-Sight 2000, InspectEdge, Inspection Designer, MVS, NotchMax, OCRMax, PatMax RedLine, ProofRead, SmartSync, ProfilePlus, SmartDisplay, SmartSystem, SMD4, VisiFlex, Xpand

Portions copyright © Microsoft Corporation. All rights reserved.

Portions copyright © MadCap Software, Inc. All rights reserved.

Other product and company trademarks identified herein are the trademarks of their respective owners.

# Precautions

To reduce the risk of injury or equipment damage, observe the following precautions when you install the Cognex product:

- This product is intended for indoor barcode reading for industrial use in automated manufacturing or similar applications.
- The safety of any system incorporating this product is the responsibility of the assembler of the system.
- Do not install Cognex products where they are exposed to environmental hazards such as excessive heat, dust, moisture, humidity, impact, vibration, corrosive substances, flammable substances, or static electricity.
- Route cables and wires away from high-current wiring or high-voltage power sources to reduce the risk of damage or malfunction from the following causes: over-voltage, line noise, electrostatic discharge (ESD), power surges, or other irregularities in the power supply.
- Do not expose the image sensor to laser light. Image sensors can be damaged by direct, or reflected, laser light. If your application requires laser light that might strike the image sensor, use a lens filter at the corresponding laser wavelength. For suggestions, contact your local integrator or application engineer.
- This product does not contain user-serviceable parts. Do not make electrical or mechanical modifications to product components. Unauthorized modifications can void your warranty.
- Changes or modifications not expressly approved by the party responsible for regulatory compliance could void the user's authority to operate the equipment.
- Include service loops with cable connections.
- Ensure that the cable bend radius begins at least six inches from the connector. Cable shielding can be degraded or cables can be damaged or wear out faster if a service loop or bend radius is tighter than 10X the cable diameter.
- This device should be used in accordance with the instructions in this manual.
- All specifications are for reference purposes only and can change without notice.

# Symbols

The following symbols indicate safety precautions and supplemental information:

---

 **WARNING:** This symbol indicates a hazard that could cause death, serious personal injury or electrical shock.

---

---

 **CAUTION:** This symbol indicates a hazard that could result in property damage.

---

---

 **Note:** This symbol indicates additional information about a subject.

---

---

 **Tip:** This symbol indicates suggestions and shortcuts that might not otherwise be apparent.

---

# Table of Contents

<b>Legal Notices</b> .....	<b>2</b>
<b>Precautions</b> .....	<b>3</b>
<b>Symbols</b> .....	<b>4</b>
<b>Table of Contents</b> .....	<b>5</b>
<b>Getting Started</b> .....	<b>7</b>
About the DataMan 80 Series .....	7
Supporting Documentation .....	8
DataMan 80 Series Accessories .....	9
Lenses .....	9
Illumination .....	10
Lens Covers .....	10
Mounting Brackets .....	11
Cables .....	11
Other Accessories .....	12
Illumination Options .....	12
DataMan 80 Series Systems .....	13
DataMan 80-PoE Systems .....	13
DataMan 80-USB Systems .....	14
<b>Setting Up Your DataMan Reader</b> .....	<b>15</b>
Reader Layout .....	15
DM80-USB Layout .....	15
DM80-PoE Layout .....	16
Indicator LEDs .....	16
Dimensions .....	17
DataMan 80-USB with 6.2 mm Lens .....	17
DataMan 80-USB with 6.2 mm Lens and Sound Amplifier .....	18
DataMan80-USB with 16 mm Lens .....	18
DataMan 80-PoE with 6.2 mm Lens .....	19
DataMan 80-PoE with 16 mm Lens .....	19
Field of View and Distance .....	20
DataMan 80 with 6.2 mm Lens .....	20
Short Range (Focused to 105 mm) .....	20
Long Range (Focused to 190 mm) .....	21
DataMan 80 Readers with 16 mm lens .....	22
Connecting the Reader .....	23
Installing and Changing Lenses .....	23
Changing a 6.2 mm Lens to a 16 mm Lens .....	23
Installing a High Speed Liquid Lens .....	27
Installing the Sound Amplifier .....	31
Mounting the Reader .....	32
Setting Focus .....	33
Manual Focus Lens .....	33
Focus Feedback .....	34

Best Practices .....	34
Connection Options .....	36
Connecting the Ethernet Cable to DataMan 80-PoE Readers .....	36
Using your DataMan 80-USB Device through USB .....	36
Emulating Serial Functionality .....	36
Emulating Ethernet Functionality .....	36
USB-Keyboard (HID) Functionality .....	36
<b>Using Your DataMan Reader .....</b>	<b>38</b>
Installing the DataMan Setup Tool .....	38
Trigger Types .....	38
External Triggers .....	39
Training the Reader .....	39
Manual Training .....	40
Training Feedback .....	40
Incremental Training for Multiple Symbologies .....	41
Industrial Protocols .....	42
<b>Specifications .....</b>	<b>43</b>
DataMan80 Series Reader .....	43
DataMan 80 Series Reader Image Sensor .....	44
LED and Laser Wavelengths .....	45
Acquisition Trigger Input .....	45
High-Speed Outputs .....	46
High Speed Output Wiring .....	47
Serial I/O Adapter (CCB-PIO-DB15-05ST) .....	48
PoE Cable (CCB-PIO-RJ50-2ST) .....	49
I/O Cable (DM-USBIO-00) .....	50
RS-232 Cable (DM-RS232IO-00) .....	50
<b>Cleaning and Maintenance .....</b>	<b>51</b>
Clean the Housing .....	51
Clean the Reader Image Sensor Window .....	51
Clean the Reader Lens Cover .....	51
<b>Regulations and Conformity .....</b>	<b>52</b>
中国大陆RoHS (Information for China RoHS Compliance) .....	53
For European Community Users .....	53

# Getting Started

This section provides general information about the DataMan 80 series reader and the accessories and systems.

## About the DataMan 80 Series

The DataMan 80 series readers are high-performance readers that offer:

- Powerful decoding in an ultra-compact package
- Flexible Industry 4.0 connectivity options
- Unmatched Modularity and Ease of Use



## Supporting Documentation

This document provides basic information about the DataMan 80 series readers. Additional information is available through the Windows **Start** menu or the DataMan Setup Tool **Help** menu after you install the DataMan software on your PC.







**Note:** For the latest documentation, visit: [support.cognex.com/documentation/dataman](http://support.cognex.com/documentation/dataman).



- The **DataMan Communications and Programming Guide** shows you how to integrate your DataMan reader into your particular automation and factory environment.  
Cognex > DataMan Software Revision: x.x.x> Documentation > Communications > DataMan Communications and Programming Guide
- The **DataMan Industrial Protocols Manual** provides information on how to integrate DataMan readers into your particular environment using industrial protocols.  
Cognex > DataMan Software Revision: x.x.x> Documentation > Communications > DataMan Industrial Protocols Manual
- The **DataMan Reader Configuration Codes** document provides printable 2-D codes that you can use to configure the DataMan reader.  
Cognex > DataMan Software Revision: x.x.x > Documentation > English > Reader Configuration Codes
- The **DM80 Quick Reference Guide** provides essential information about the DM80 reader.  
Cognex > DataMan Software Revision: x.x.x > Documentation > English > DM80 Series > DM80 Quick Reference Guide
- The **DataMan Fixed-Mount Readers Reference** is a complete online hardware reference for the DataMan fixed-mount ID readers.  
Cognex > DataMan Software Revision: x.x.x > Documentation > English > DM80 > Fixed-Mount Reference Manual
- The **DataMan Questions and Answers** document provides context-sensitive information. You can view this help inside the DataMan Setup Tool or as a stand-alone help file.  
Cognex > DataMan Software Revision: x.x.x > Documentation > DM80 > Questions and Answers
- The **DataMan Control Commands** lists DataMan Control Commands with all relevant information. You can view this help inside the Setup Tool or as a stand-alone help file.  
Cognex > DataMan Software Revision: x.x.x > Documentation > English > DataMan Control Commands
- The **Setup Tool Reference Manual** describes the user interface of the DataMan Setup Tool software.  
Cognex > DataMan Software Revision: x.x.x> Documentation > English > Setup Tool Reference Manual
- The **Release Notes** list detailed system requirements and additional information about the DataMan software release.  
Cognex > DataMan Software Revision: x.x.x > Documentation > DataMan Revision: x.x.x > Release Notes

## DataMan 80 Series Accessories



You can purchase the following components separately. For a list of options and accessories, contact your local Cognex sales representative.

### Lenses

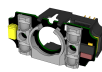

Accessory	Product Number	Illustration
6.2 mm lens kit that includes: <ul style="list-style-type: none"> <li>• 6.2 mm optics mount</li> <li>• 6.2 mm lens</li> <li>• Manual lens cap (assembled)</li> <li>• Screws</li> </ul>	DM280-LENS-62	
UV Light Kit for 6.2 mm lens (Risk Group Exempt acc. IEC 62471) <ul style="list-style-type: none"> <li>• UV light board (365 nm wavelength)</li> <li>• UV resistant front cover</li> <li>• Screws</li> </ul>	DM280-UV365-62	
16 mm lens kit with extended optics mount (requires the use of an extended front cover and high-powered red LED). The kit includes: <ul style="list-style-type: none"> <li>• 16 mm optics mount</li> <li>• 16 mm lens</li> <li>• Manual lens cap (assembled)</li> <li>• Screws</li> </ul>	DM260-LENS-16	
IR 6.2 mm lens kit, 3-position with IR LED includes: <ul style="list-style-type: none"> <li>• 6.2 mm optics mount</li> <li>• 6.2 mm lens (IR)</li> <li>• Standard Infrared Light for 6.2mm (Risk Group Exempt acc. IEC62471)</li> <li>• Manual lens cap (not assembled)</li> <li>• Screws</li> </ul>	DM280-KIT-IR-62	
IR 16 mm lens kit that includes: <ul style="list-style-type: none"> <li>• 16 mm optics mount</li> <li>• 16 mm lens (IR)</li> <li>• Standard Infrared Light for 16mm (Risk Group Exempt acc. IEC62471)</li> <li>• Manual lens cap (assembled)</li> <li>• Screws</li> </ul>	DMA-KIT-IR-16	
High Speed Liquid Lens Module (HSLL) to be used with 6.2 mm lens or 16 mm lens	DMA-HSLL-280	

Accessory	Product Number	Illustration
16 mm lens with ImageMax kit that includes: <ul style="list-style-type: none"> <li>• 16 mm optics mount</li> <li>• 16 mm lens</li> <li>• High Speed Liquid Lens Module (DMA-HSLL-280)</li> <li>• High Powered red LED illumination (DM260-LED-RED-HP) (Risk Group Exempt acc. IEC62471)</li> <li>• 2-LED half-polarized extended cover (DM260-LENS-16CVR-P) (Risk Group Exempt acc. IEC62471)</li> </ul>	DM280-KIT-IMGMAX	
Blue bandpass filter	DM150-BP470	
Red bandpass filter	DM150-BP635	



## Illumination

Accessory	Product Number	Illustration
Red LED Light for 6.2 mm Lens (Risk Group Exempt acc. IEC 62471)	DM150-LED-RED	
White LED Light for 6.2 mm Lens (Risk Group Exempt acc. IEC 62471)	DM150-LED-WHT	
Blue LED Light for 6.2 mm Lens (Risk Group Exempt acc. IEC 62471)	DM150-LED-BLU	
High-Powered Red LED Light for 16 mm Lens (Risk Group Exempt acc. IEC 62471)	DM280-LED-RED-HP	
High-Powered White LED Light for 16 mm Lens (Risk Group Exempt acc. IEC 62471)	DM280-LED-WHT-HP	

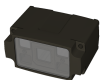
## Lens Covers





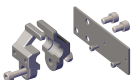



Accessory	Product Number	Illustration
Standard front cover. Use with a 6.2 mm lens only.	DM280-CVR-62	
Standard front cover, half-polarized. Use with a 6.2 mm lens only.	DM280-LENS-62CVR-P	
Standard front cover, fully-polarized. Use with a 6.2 mm lens only.	DM280-LENS-62CVR-F	
Extended front cover. Use with a 16 mm lens only.	DM260-LENS-16CVR	
Extended front cover, half-polarized. Use with a 16 mm lens only.	DM260-LENS-16CVR-P	
Extended front cover, fully-polarized. Use with a 16 mm lens only.	DM260-LENS-16CVR-F	

## Mounting Brackets

Accessory	Product Number	Illustration
Universal mounting bracket	DM100-UBRK-000	
Pivot mounting bracket	DM100-PIVOTM-01	
Tilted angle pivot bracket	DMBK-DMPIVOT-00	
Logistics mounting bracket and plate kit	DMA-BKT-LGS	

## Cables

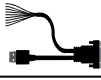
**Note:** Cables are sold separately.

Accessory	Product Number	Illustration	DM80-USB	DM80-PoE
Locked IP67 USB Type C Cable to USB Type A, Straight, 2.5 m	DMA-STCBLE-IP65-25		✓	
Locked IP67 USB Type C Cable to USB Type A, Straight 3.6 m	DMA-STCBLE-IP65-36		✓	
Locked IP67 USB Type C Cable to USB Type A, Angled, 2.5 m	DMA-RTCBLE-IP65-25		✓	
Locked IP67 USB Type C Cable to USB Type A, Angled, 3.6 m	DMA-RTCBLE-IP65-36		✓	
Locked IP67 RJ50 to RJ45 PoE with Flying Leads, Straight, 2 m	CCB-PIO-RJ50-2ST			✓
Locked IP67 RJ50 to RJ45 PoE with Flying Leads, Right Angle, 2 m	CCB-PIO-RJ50-2RA			✓
Locked IP67 USB-C to DB15, Straight 0.5 m	CCB-PIO-DB15-05ST		✓	
Locked IP67 USB-C to DB15, Right Angle, 0.5 m	CCB-PIO-DB15-05RA		✓	
USB I/O Cable with Flying Leads, 2.0 m	DM-USBIO-00		✓	
RS-232 I/O Cable with flying leads, 2.5 m	DM-RS232IO-00		✓	

## Other Accessories

Accessory	Product Number	Illustration	DM80-USB	DM80-PoE
Sound Amplifier	DM80-AMP		✓	

## Illumination Options

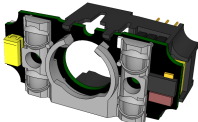
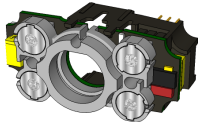
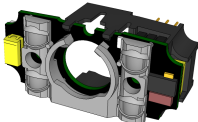
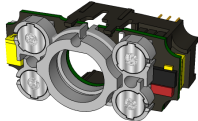
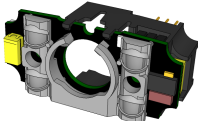
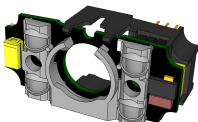
Illumination Board	Powered through USB or PoE	
	Max. Exposure Time	Max. Duty Cycle
<b>Standard Red</b> 	1 ms	6%
<b>High Power Red</b> 	1 ms	6%
<b>Standard White</b> 	1 ms	6%
<b>High Power White</b> 	1 ms	6%
<b>Standard Blue</b> 	1 ms	6%
<b>IR</b> 	1 ms	6%

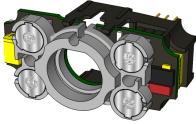
Illumination Board	Powered through USB or PoE	
	Max. Exposure Time	Max. Duty Cycle
<b>High Power IR</b> 	1 ms	6%

## DataMan 80 Series Systems

### DataMan 80-PoE Systems

	Omni-directional 1D Code	1D Max with Hotbars	High Speed Decoding	2DMax - Hard to read 2D codes	PowerGrid - Damaged 2D codes	Multi-Reader Sync	Resolution
DM-80L 1D Codes		✓	✓			✓	1440 x 1080
DM-80QL 1D Codes	✓	✓	✓			✓	
DM-80S 1D/2D Codes	✓	✓				✓	
DM-80Q 1D/2D Codes	✓	✓	✓	✓		✓	
DM-80X 1D/2D Codes	✓	✓	✓	✓	✓	✓	

## DataMan 80-USB Systems

	Omni-directional 1D Code	1D Max with Hotbars	High Speed Decoding	2DMax - Hard to read 2D codes	PowerGrid - Damaged 2D codes	Resolution
DM-80L 1D Codes		✓	✓			1440 x 1080
DM-80QL 1D Codes	✓	✓	✓			
DM-80S 1D/2D Codes	✓	✓				
DM-80Q 1D/2D Codes	✓	✓	✓	✓		
DM-80X 1D/2D Codes	✓	✓	✓	✓	✓	

# Setting Up Your DataMan Reader

Read this section to learn how the reader connects to its standard components and accessories.

**Note:**



- Cables are sold separately.
- If a standard component is missing or damaged, immediately contact your Cognex Authorized Service Provider (ASP) or Cognex Technical Support.



**CAUTION:** All cable connectors are keyed to fit the connectors on the reader. Do not force the connections or damage may occur.

## Reader Layout

### DM80-USB Layout

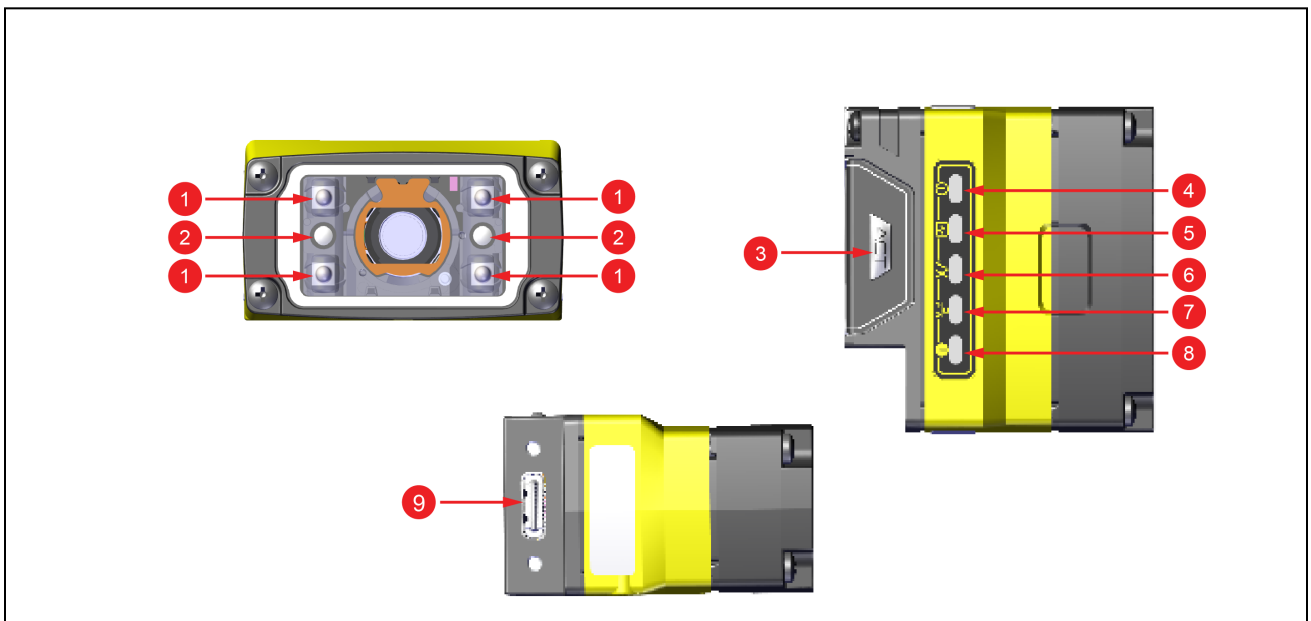

Number	Description
1	Illumination LEDs
2	LED aimers
3	ACT button
4	Power LED indicator
5	Train status/Trigger status LED indicator
6	Good/bad read LED indicator
7	Communication LED indicator
8	Error LED indicator
9	USB-C slot

## DM80-PoE Layout

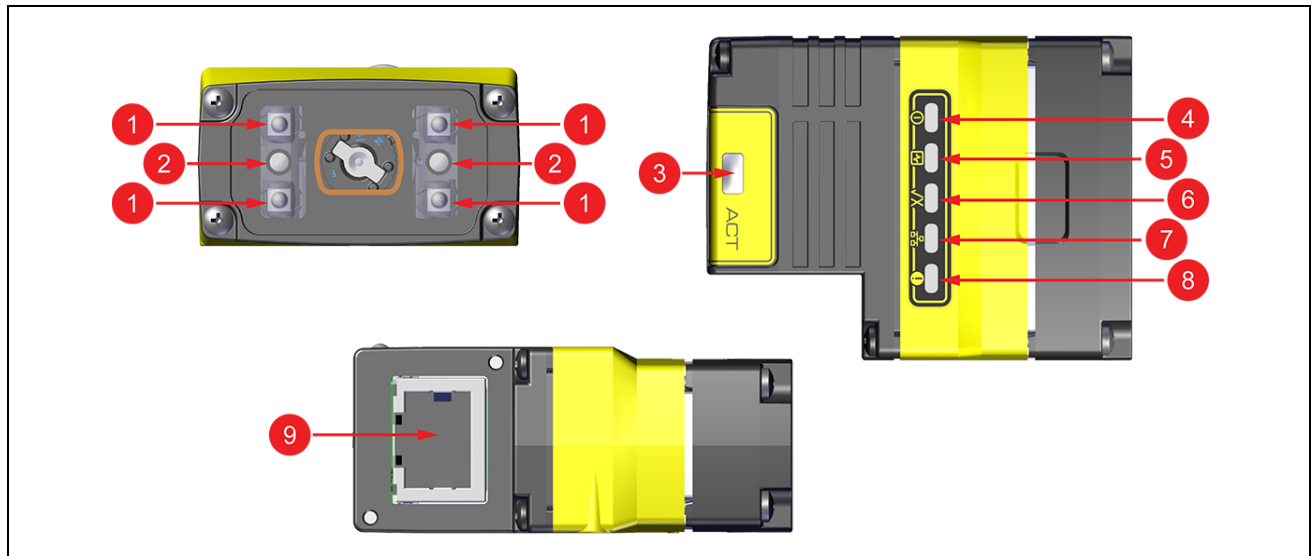

Number	Description
1	Illumination LEDs
2	LED aimers
3	ACT button
4	Power LED indicator
5	Train status/Trigger status LED indicator
6	Good/bad read LED indicator
7	Communication LED indicator
8	Error LED indicator
9	Ethernet connector

## Indicator LEDs

The table summarizes the functions of the indicator LEDs on DataMan 80 readers.

Indicator	Color/Status	Meaning
Power indicator LED	ON	The device is ON.
	OFF	The device is OFF.
	GREEN	The DM80-USB is receiving sufficient power from the USB-C connector on the host or through BC 1.2 support.
	RED	The connected host cannot guarantee enough power for the DM80-USB to operate properly.
Train/Trigger status indicator LED	ON	If the device has a trained code, this LED is GREEN.
	OFF	If the device has no trained code, this LED is OFF.

Indicator	Color/Status	Meaning
Good/Bad read indicator LED	GREEN, blinking	The device performs a good read. <b>Note:</b> In case of a good read, light edges are also blinking in GREEN.
	RED, blinking	The device performs a bad read when it does not find a decoding after a timeout. <b>Note:</b> In case of a bad read, light edges are also blinking in RED.
Communication	ON	This LED is on when the DataMan 80 reader established a physical or virtual Ethernet connection. DataMan 80-PoE readers have a physical connection, while DataMan 80-USB readers have a virtual Ethernet connection.
	OFF	This LED is OFF when there is no Ethernet connection.
Error	ON	This LED is on if the DataMan 80 reader detects an error.

## Dimensions

The following sections list dimensions of the reader.

**Note:**



- Dimensions are in millimeters and are for reference purposes only.
- All specifications are for reference purposes only and can change without notice.

### DataMan 80-USB with 6.2 mm Lens

The following image shows the dimensions of DataMan 80, equipped with 6.2 mm lens.

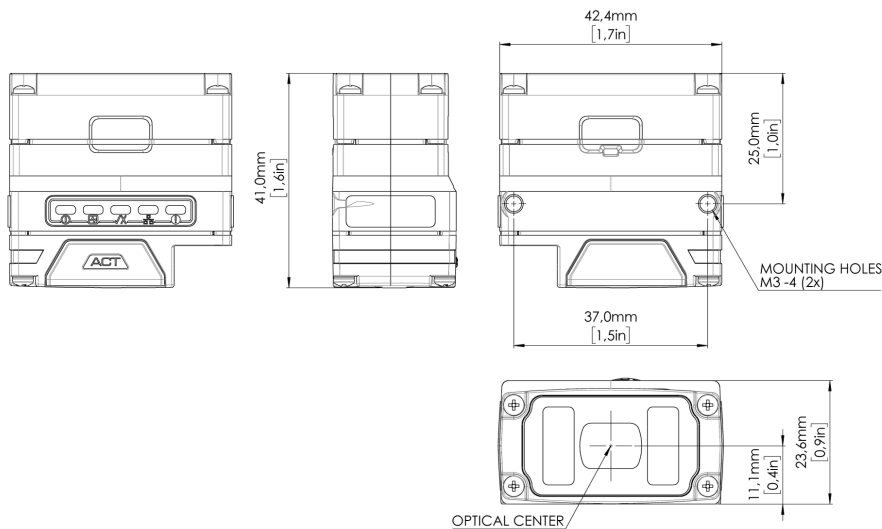

## DataMan 80-USB with 6.2 mm Lens and Sound Amplifier

The following image shows the dimensions of DataMan 80, equipped with 6.2 mm lens and the Sound Amplifier attachment.

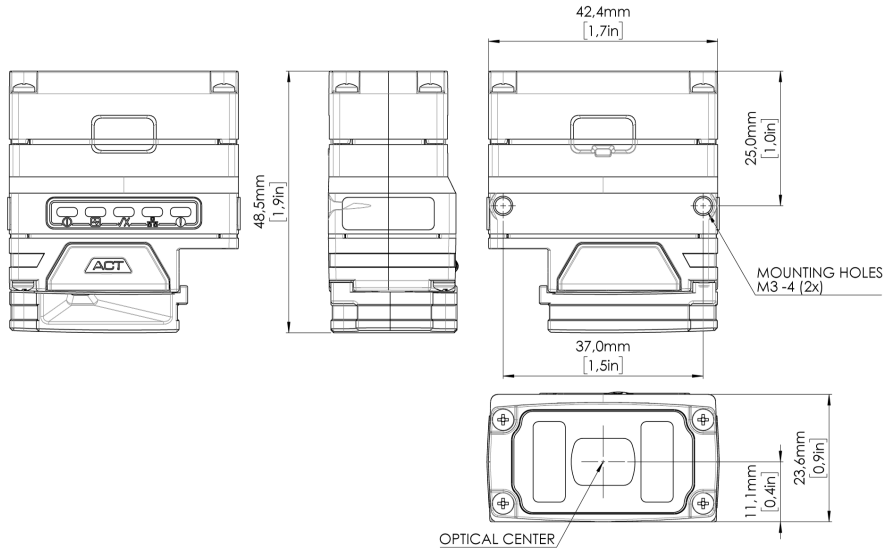

## DataMan80-USB with 16 mm Lens

The following image shows the dimensions of DataMan80, equipped with 16 mm lens.

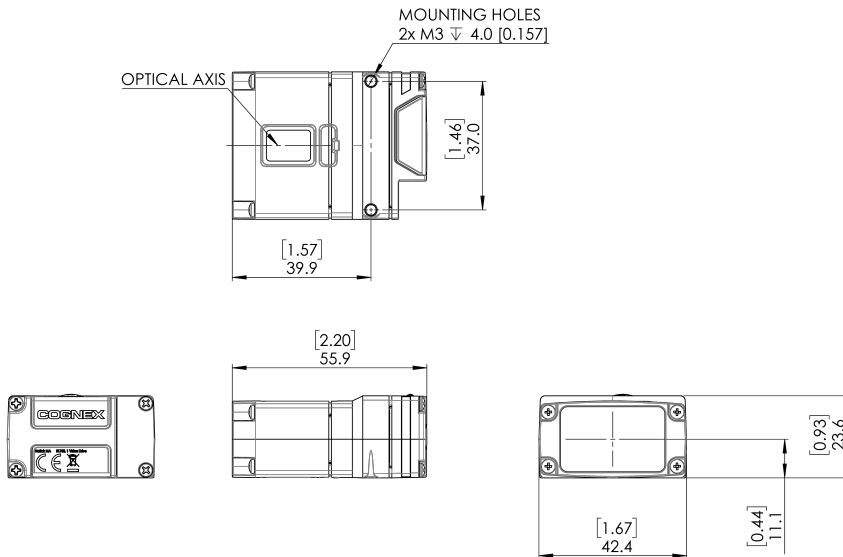

## DataMan 80-PoE with 6.2 mm Lens

The following image shows the dimensions of DataMan80-PoE equipped with 6.2 mm lens.

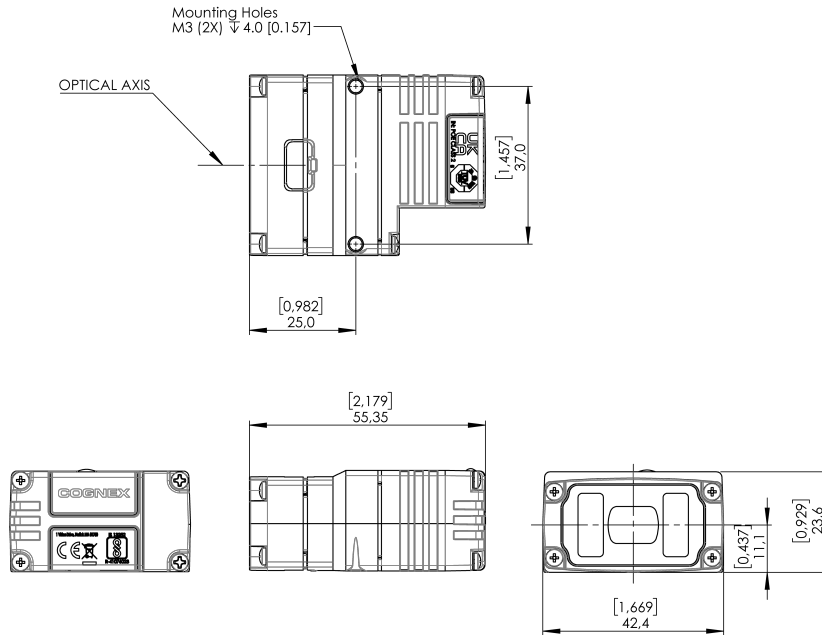

## DataMan 80-PoE with 16 mm Lens

The following image shows the dimensions of DataMan80-PoE equipped with 16 mm lens.

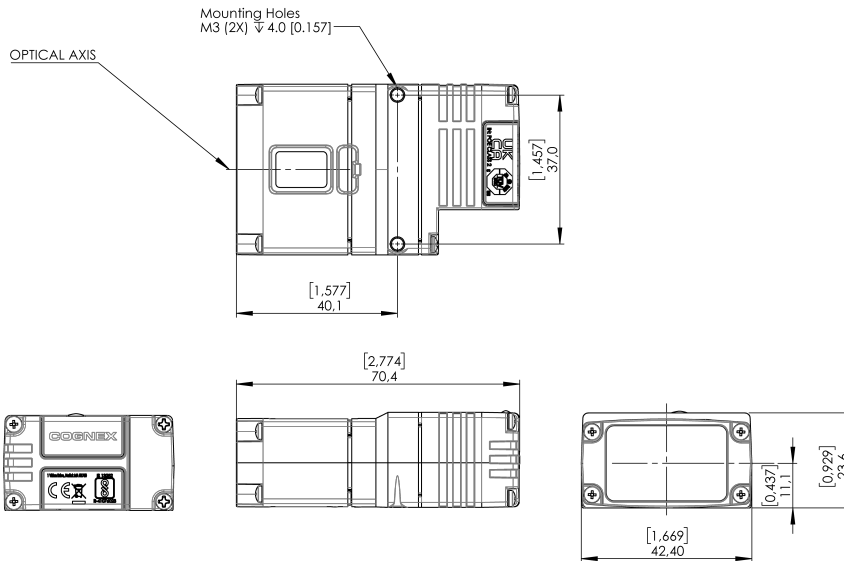

## Field of View and Distance

This section provides the Field of View (FoV) values for 6.2 mm and 16 mm lenses.

### DataMan 80 with 6.2 mm Lens

#### Short Range (Focused to 105 mm)

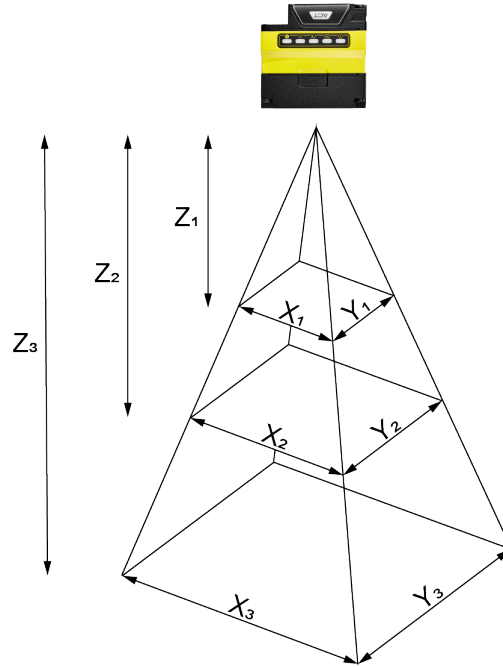

The following tables show the Field of View (FoV) widths of the 6.2 mm lens focused to 105 mm at various distances.

Working distance in mm	Horizontal values in mm	Vertical values in mm
$Z_1 = 40$	$X_1 = 38$	$Y_1 = 29$
$Z_2 = 65$	$X_2 = 58$	$Y_2 = 44$
$Z_3 = 105$	$X_3 = 90$	$Y_3 = 68$

Distances in mm	2D min. code in mil	1D min. code in mil
40	4	2
65	5	3
105	10	5

Long Range (Focused to 190 mm)

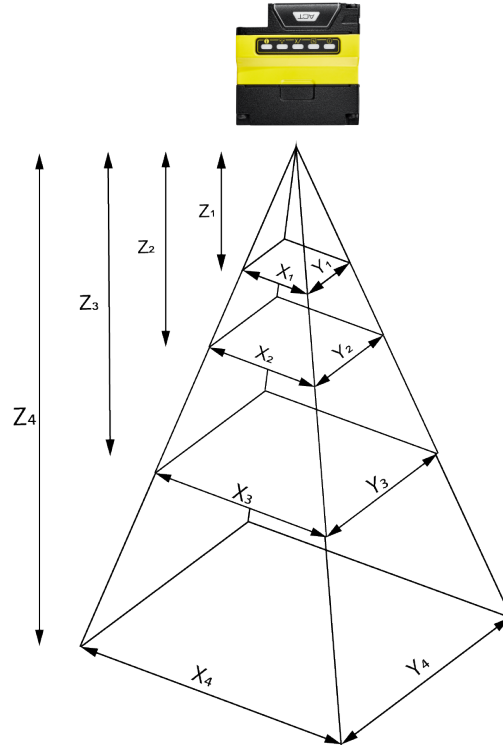

The following table shows the Field of View (FoV) widths of the 6.2 mm lens focused to 190 mm at various distances.

Working distance in mm	Horizontal values in mm	Vertical values in mm
Z <sub>1</sub> = 190	X <sub>1</sub> = 159	Y <sub>1</sub> = 119
Z <sub>2</sub> = 225	X <sub>2</sub> = 187	Y <sub>2</sub> = 140
Z <sub>3</sub> = 375	X <sub>3</sub> = 307	Y <sub>3</sub> = 230
Z <sub>4</sub> = 1000	X <sub>4</sub> = 808	Y <sub>4</sub> = 606

Distances in mm	2D min. code in mil	1D min. code in mil
150	10	6
190	12	8
225	15	8
375	20	15
500	30	20
1000	60	35

## DataMan 80 Readers with 16 mm lens

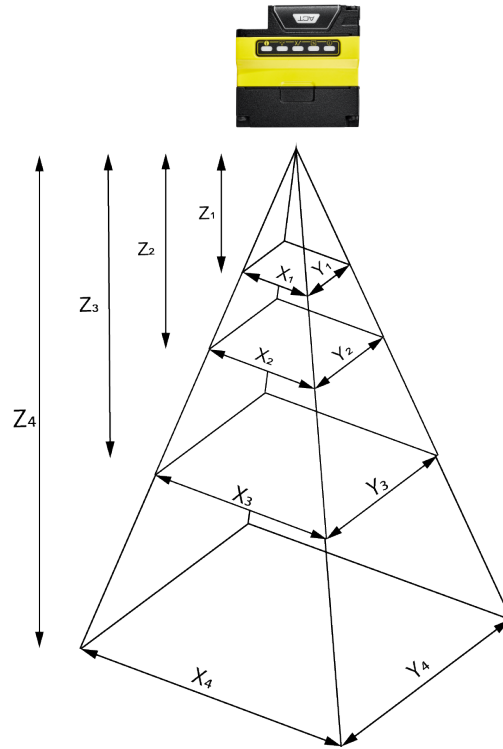

The following tables list the Field of View (FoV) widths of the 16 mm lens at various distances:

Working distance in mm	Horizontal values in mm	Vertical values in mm
$Z_1 = 150$	$X_1 = 46$	$Y_1 = 34$
$Z_2 = 225$	$X_2 = 69$	$Y_2 = 52$
$Z_3 = 375$	$X_3 = 116$	$Y_3 = 87$
$Z_4 = 1000$	$X_4 = 310$	$Y_4 = 232$

Distances in mm	2D min. code in mil	1D min. code in mil
80	2	2
150	3	2
190	4	3
225	5	3
375	8	5
500	10	7
1000	20	15

## Connecting the Reader



1	<a href="#">Installing the Sound Amplifier on page 31</a>
2	<a href="#">Mounting the Reader on page 32</a>
3	<a href="#">Connecting the Ethernet Cable to DataMan 80-PoE Readers on page 36</a>
4	<a href="#">Using your DataMan 80-USB Device through USB on page 36</a>

## Installing and Changing Lenses

This section provides an overview about installing and changing different kinds of lenses.

- [Changing a 6.2 mm Lens to a 16 mm Lens on page 23](#)
- [Installing a High Speed Liquid Lens on page 27](#)

**Note:** Use a Phillips screwdriver with drive size #1 for all Phillips screws that are reachable from the front side.

**Note:** Disconnect the reader from power before changing lenses or mounts.

**CAUTION:** Perform all lens modification procedures in a dust-free and ESD safe area.

### Changing a 6.2 mm Lens to a 16 mm Lens

This section provides a step-by-step process for changing the 6.2 mm lens to a 16 mm lens on the reader.

1. Unscrew the four M2x12mm Phillips Pan head screws, then take off the metal cover from the reader.

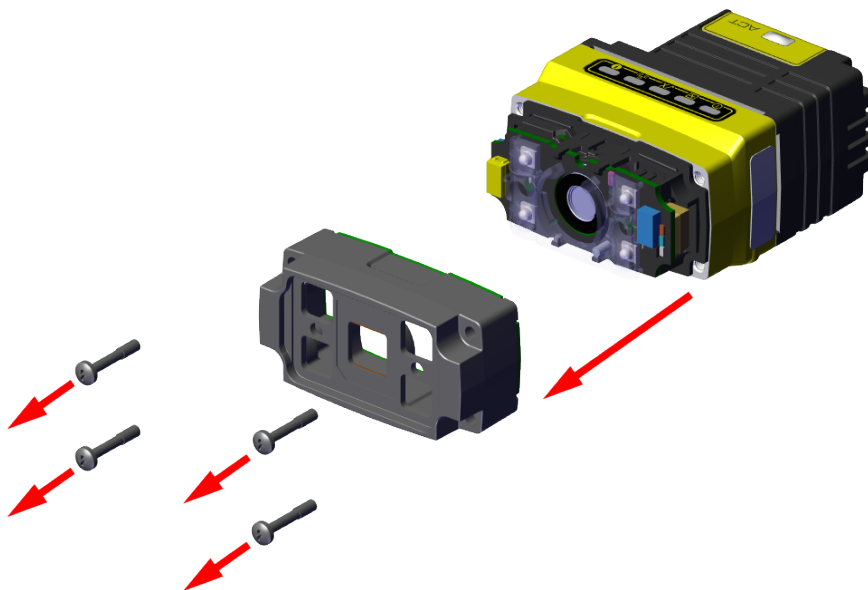

2. Remove the illumination module.

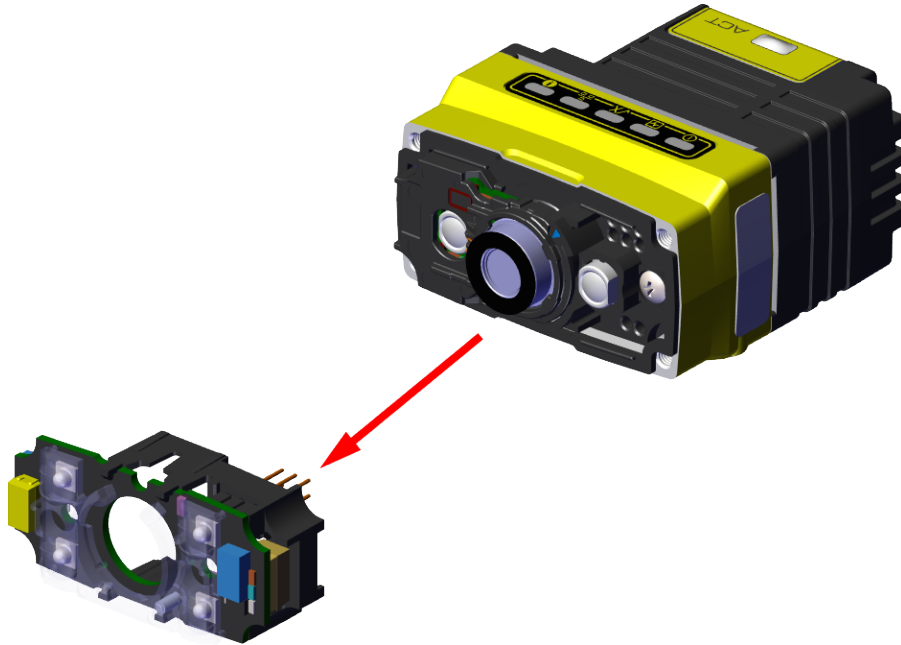

3. Unscrew the two M2x5mm Phillips head screws, remove the 6.2 mm lens mount and the 6.2 mm lens.



4. Attach the 16 mm lens mount and lens, and screw in the two M2x5mm Phillips head screws. Focus, if necessary. For more information, see [Setting Focus on page 33](#).

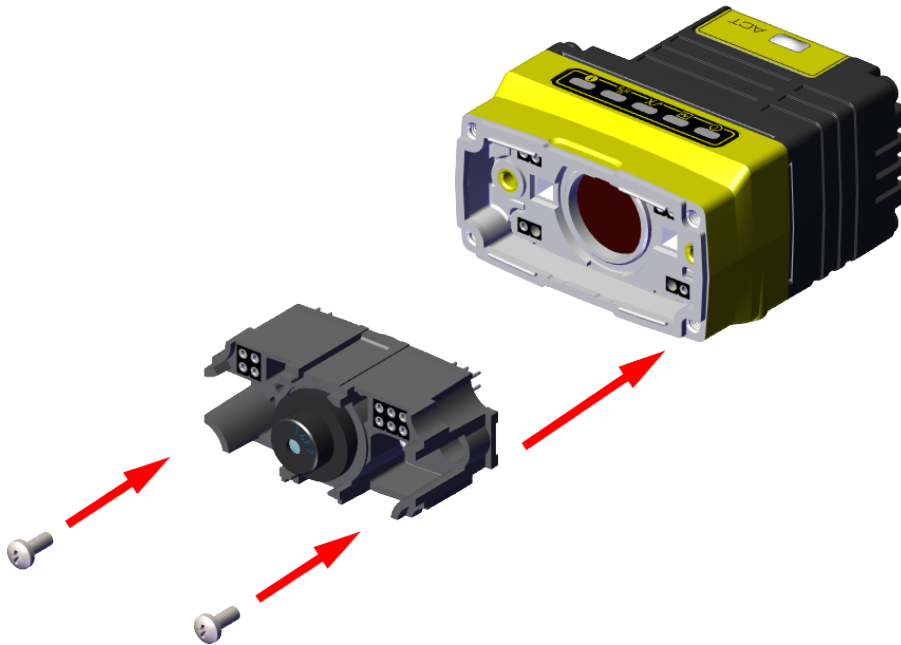

5. Attach the 16 mm lens illumination module.

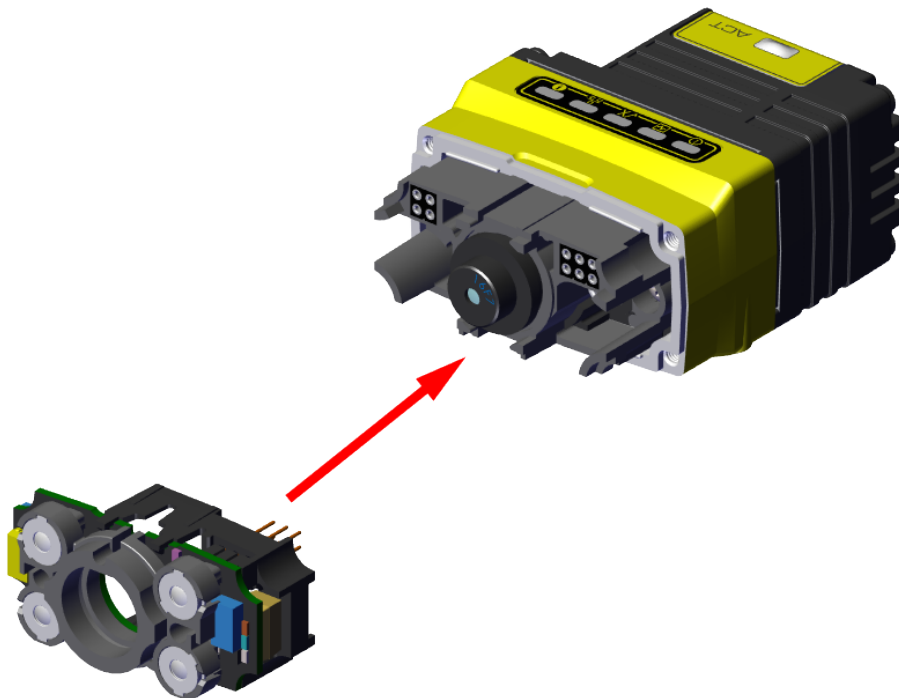

6. Attach the 16 mm lens front cover.

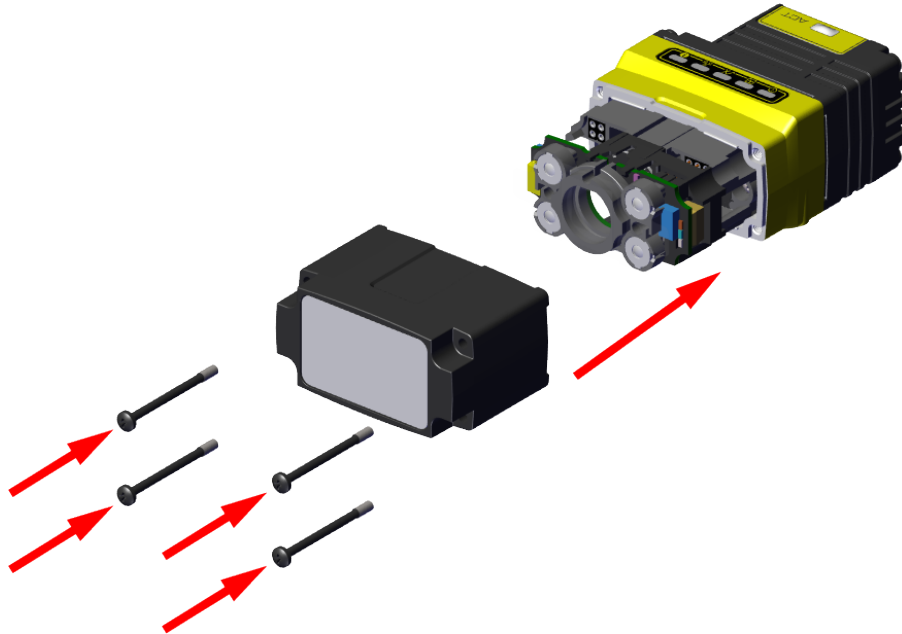

**Note:** The rib in the front cover must be oriented to the top side.

**Note:** Observing the tightening sequence below, tighten all four M2 x 12 mm Phillips Pan screws to 16 Ncm using a torque wrench.

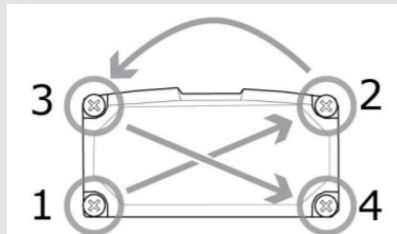

## Installing a High Speed Liquid Lens

This section shows the process of installing a liquid lens onto the DataMan 80 with a 6.2 mm lens.

1. Unscrew the four M2 x 12 mm Phillips Pan head screws, then take off the metal cover from the reader.

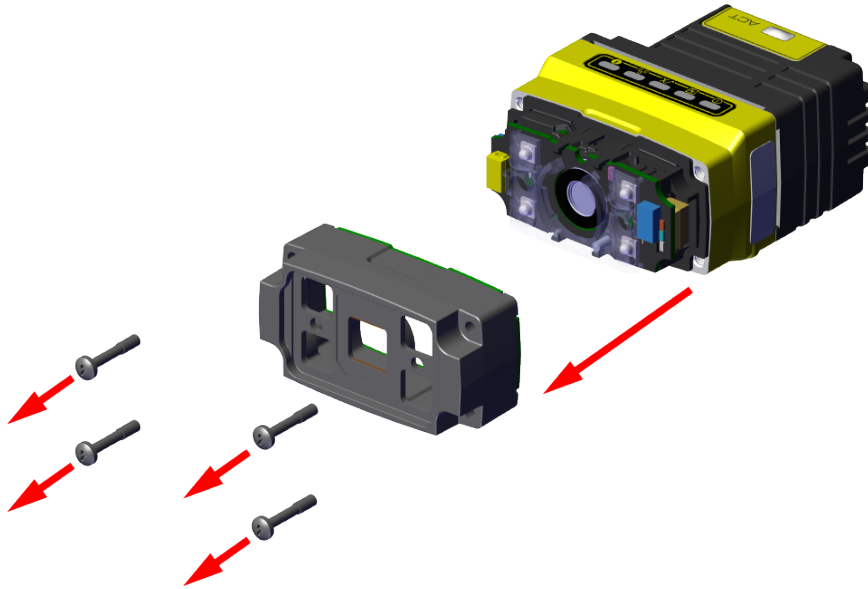

2. Remove the illumination module.



3. Turn the lens cap to the 105 mm position.



- Carefully remove the lens cap from the imager lens.



**Note:** In order not to lose focus calibration, do not rotate the imager lens while the lens cap is removed.

- Attach the liquid lens accessory by aligning the 2x2 connectors of the liquid lens with the 2x2 sockets on the optics mount.



6. Press the liquid lens onto the imager lens until you reach the stop.



7. Re-attach the illumination module.

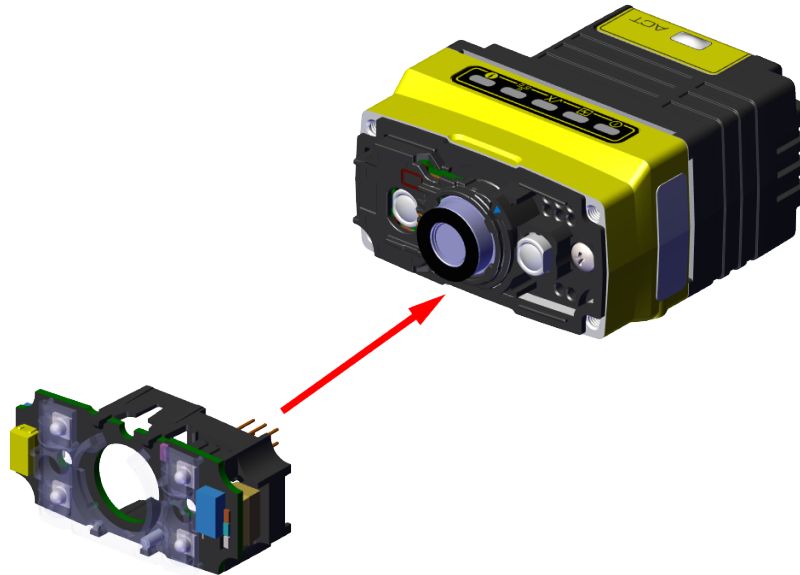

8. Re-attach the front cover.

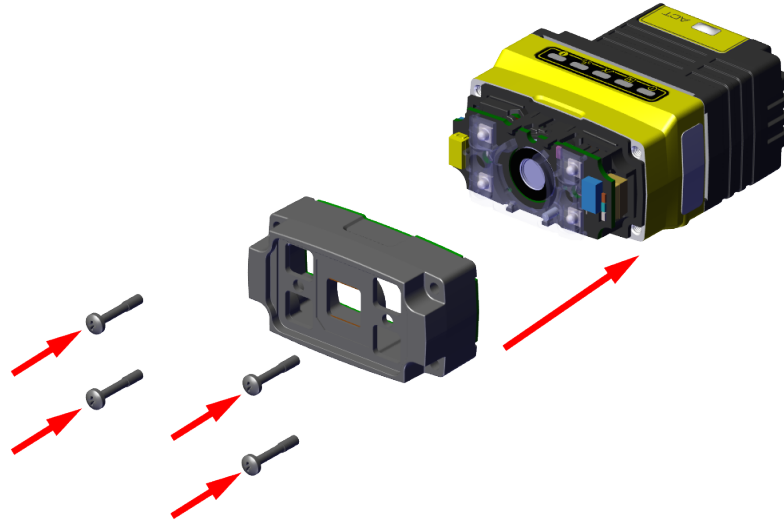

**Note:** The rib in the front cover must be oriented to the top side.

**Note:** Observing the tightening sequence below, tighten all four M2 x 12 mm Phillips Pan screws to 16 Ncm using a torque wrench.

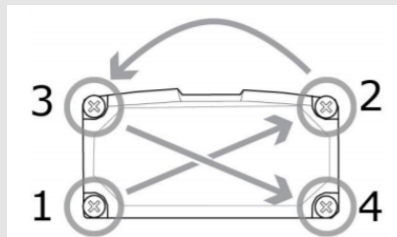

## Installing the Sound Amplifier

The sound amplifier accessory increases the volume of the DataMan 80 to assist users in loud environments. You have to manually install the sound amplifier to the back of the reader.

**Note:** Before you install the sound amplifier, make sure that the DataMan 80 housing is clean and free of oils.

1. Remove the protective film from the adhesive surface of the sound amplifier.

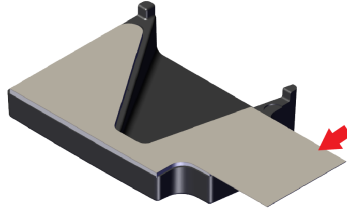

2. Use the two pegs to align the sound amplifier to the DataMan 80 backplate. The sound output points in the direction of the button on the reader.



3. Rotate the sound amplifier onto the surface of the DataMan 80 backplate.



4. Press the sound amplifier firmly onto the DataMan 80 backplate until it is securely attached.



## Mounting the Reader

The reader provides mounting holes for attachment to a mounting surface.

**CAUTION:** The reader has to be grounded, either by mounting the reader to a fixture that is electrically grounded or by attaching a wire from the reader's mounting fixture to frame ground or Earth ground. If a ground wire is used, it has to be attached to one of the two mounting points on the bottom plate of the reader and not to the mounting points on the front of the reader.

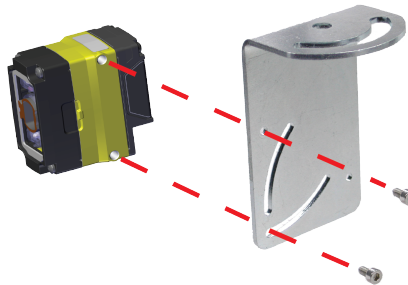

Align the holes on the mounting surface with the mounting holes on the reader. Insert the M3 screws into the mounting holes.

**Note:**

Mounting the reader at a slight angle (15°) reduces reflections and improves performance.

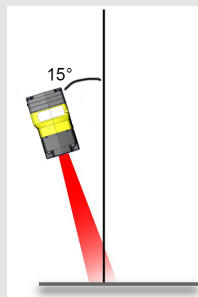

## Setting Focus

There is a range of reading distances available for different code sizes and focus positions. To set focus on your reader, use the following options depending on whether you use a liquid lens or a manual focus lens.

DataMan readers are compatible with multiple different lenses. Each lens has a range of reading distances available for different code sizes and focus positions. Having accurate focus settings is essential to maximize read rates.

To set the focus on your reader, use the following options depending on whether you use a liquid lens or a manual focus lens.

**Note:**

The DataMan Setup Tool has focus sheets that can help you manually adjust lenses or swapping between them.

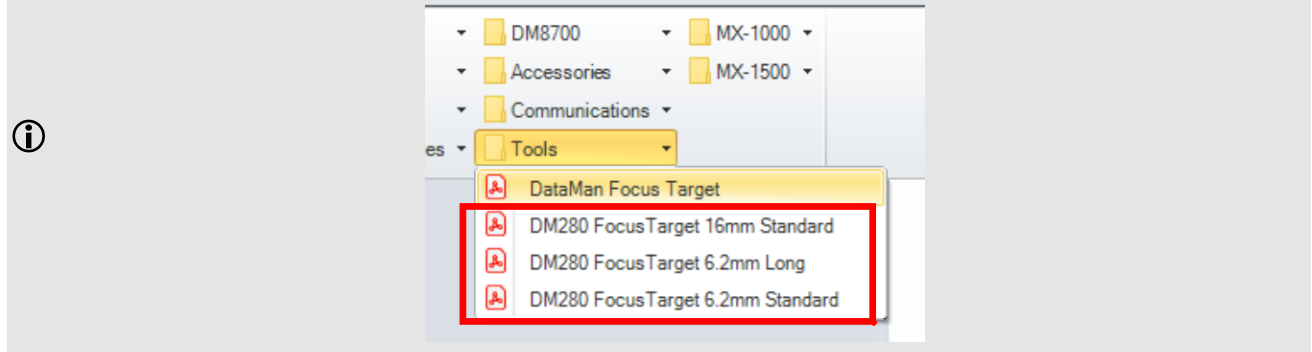

## Manual Focus Lens

Click the **Focus Feedback** button in the image panel in SetupTool to enable focus feedback.

This enables a color-coded focus feedback bar on the right side of the image panel. Once focus feedback is enabled, enter live mode and manually adjust the lens until the focus feedback bar is green.

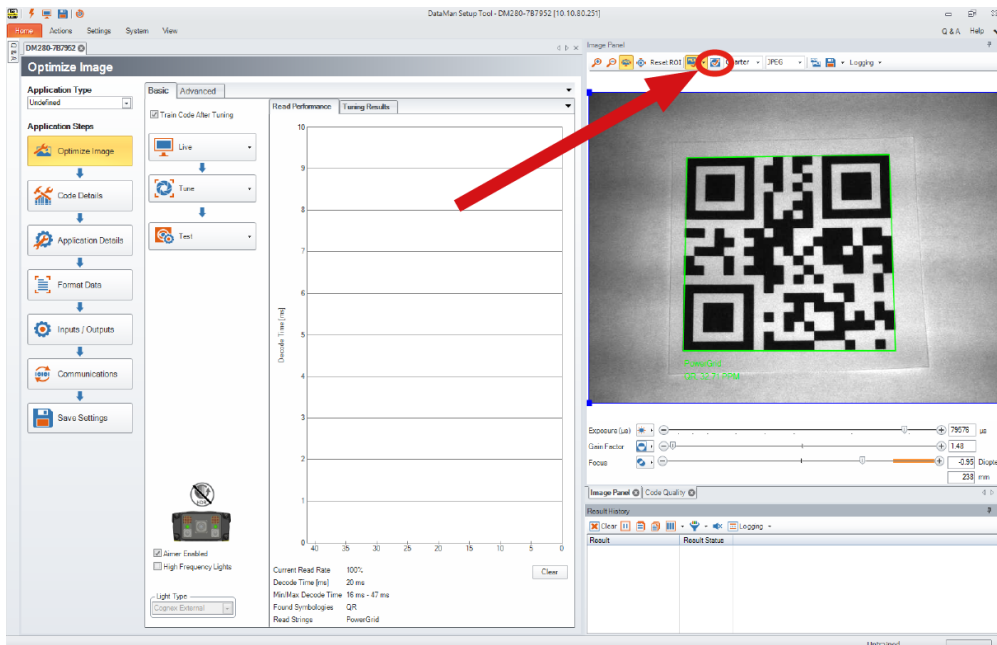

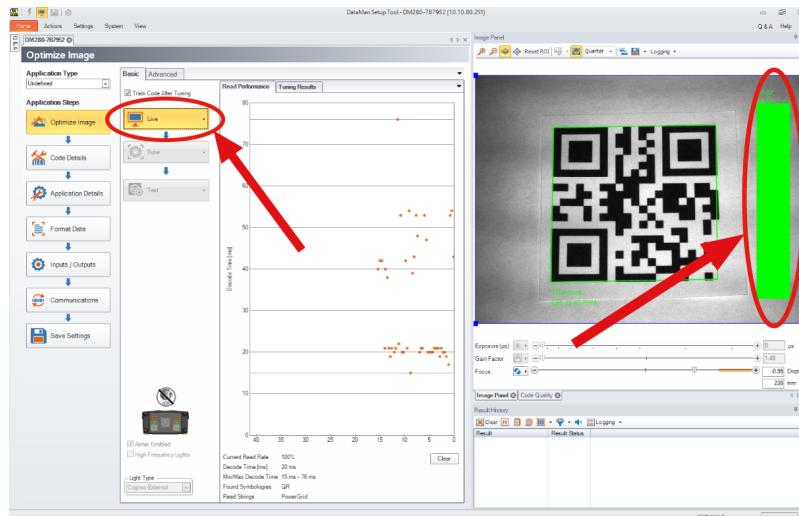

## Focus Feedback

Focus is indicated by colors ranging from red (bad focus) to green (sharp focus). When focusing the reader, you need to adjust its position until the focus column becomes green.

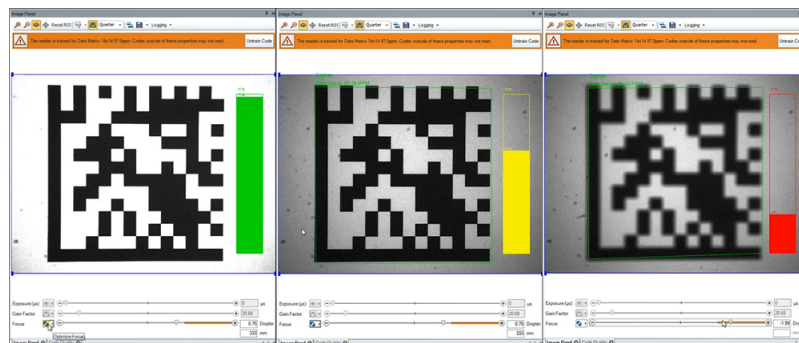

## Best Practices

Both **Optimize Focus** and the **Focus Feedback** use the same procedure for testing the current focus. They consider various sub-regions of the image.

Follow these guidelines to maximize the performance of **Optimize Focus** and **Focus Feedback**:

- Use a focus target (such as the one supplied with this Reference Manual) that includes high-contrast features and is big enough that it fills at least a 100 x 100 pixel region in the center of the field of view at the desired working distance.
- Avoid floppy pieces of paper and make sure the target is perfectly flat.
- Make sure that the target is perfectly perpendicular to the optical axis of the reader.
- Make sure that the rest of the field of view, such as the part not covered by the focus target, does not contain any high-contrast features. For example, you would ideally fill the entire field of view with a white card or sheet of paper (to avoid shadows), and position the focus target in the middle.
- The supplied 120 x 120 mm focus target is appropriate for typical working distances. If you use such a working distance that the target does not completely fill the image, make sure that there are no high-contrast features visible outside of the target (see previous bullet).

**Note:**



- If you use the focus feedback indicator to adjust a manual focus lens, you must apply power to the reader before you remove the cover. If you remove the cover before applying power, the internal illumination will not function.
- If you use a Liquid Lens, make sure that the cover is mounted and connected before you apply power. If you attach or remove the front cover while the reader is powered, the focus setting is lost.

## Connection Options

This section summarizes connection options.

For more information on how to connect your DataMan reader to your network, see the *DataMan Communications and Programming Guide*.

## Connecting the Ethernet Cable to DataMan 80-PoE Readers

**CAUTION:** The Ethernet cable shield has to be grounded at the far end. Whatever this cable is plugged into (typically a switch or router) should have a grounded Ethernet connector. A digital voltmeter has to be used to validate the grounding. If the far end device is not grounded, a ground wire should be added in compliance with local electrical codes.

**Note:** Make sure to power the reader through a PoE (Power over Ethernet) connection.

1. Connect the RJ-50 connector of the CCB-PIO-RJ50-2ST/RA cable to the Ethernet connector of the reader.
2. Connect the RJ-45 connector of the CCB-PIO-RJ50-2ST/RA cable to a switch, router, or PC, as applicable.

## Using your DataMan 80-USB Device through USB

You can use the USB connector of the DataMan 80-USB in the following ways:

- Emulating serial (USB-COM) functionality  
The DataMan 80 establishes the connection through emulated serial port.
- Emulating Ethernet functionality  
The DataMan 80 establishes the connection through emulated Ethernet.
- As HID (Human Interface Device)  
If you use DataMan 80 in HID mode, the device serves as an emulated keyboard.

### Emulating Serial Functionality

If you connect a USB-C cable, you can see a COM port in the Windows Device Manager, as a generic USB-COM port.

To emulate serial functionality:

1. Set the **USB Connection** properties in the **Serial** tab of the **Communication Settings** panel in DataMan Setup Tool.
2. Look at the Windows Device Manager to identify the proper device.
3. Enable the **Serial-over-USB** option in DataMan Setup Tool, because it is disabled by default.

### Emulating Ethernet Functionality

#### USB-Keyboard (HID) Functionality

To use the DataMan 80 as an emulated keyboard, set the language of the keyboard in the DataMan Setup Tool. HID reports use the keyboard language set in the drop down menu.

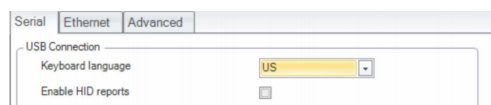

To enable HID reports, tick the checkbox in DataMan Setup Tool.

**Note:**



- Communication through HID reports is similar to using a physical keyboard.
- Using keyboard emulation with applications supporting hotkeys can result in unexpected behavior, depending on the data of the read codes.

# Using Your DataMan Reader

This section provides information on the installation of the DataMan Setup Tool, trigger types, and protocols.

## Installing the DataMan Setup Tool

Follow the steps below to install and connect your reader to the DataMan Setup Tool:

1. Check the DataMan **Release Notes** for a full list of system requirements.
2. Download the latest version of the DataMan Setup Tool from [support.cognex.com/downloads/dataman/software-firmware](http://support.cognex.com/downloads/dataman/software-firmware) and follow the on-screen steps.
3. Connect the 80 series reader to your PC:
  - You can connect your DM80-PoE reader directly to your PC or to the same network to which your PC is connected.
  - You must connect DM80-USB reader directly to your PC.
4. Launch the DataMan Setup Tool and click **Refresh**. Detected devices appear under **COM ports** or **Network devices**, or both.
5. Select a reader from the list and click **Connect**.

## Trigger Types

The DataMan 80 readers support the following trigger modes:

- **Self**: At a time interval you configure, the reader acquires an image and runs the job continuously.
- **Single** (external trigger): Acquires a single image and attempts to decode any symbol it contains, or more than one symbol in cases where multicode is enabled. The reader relies on an external trigger source.
- **Presentation**: Scans, decodes and reports a single code in the field of view. The reader relies on an internal timing mechanism to acquire images.
- **Manual**: Begins acquiring images when you press the ACT button on the reader, and continues acquiring images until a symbol is found and decoded or you release the button.
- **Burst** (external trigger): Performs multiple image acquisitions based on an external trigger and decodes any symbol appearing in a single image or within a sequence of images, or multiple symbols in a single image or within a sequence of images when multicode is enabled. You can control the number of images within each burst and the interval between image acquisitions.
- **Continuous** (external trigger): Begins acquiring images based on a single external trigger and continues to acquire and decode images until a symbol is found and decoded, or until multiple images containing as many codes as specified in multicode mode are located, or until the trigger is released. You can configure your reader to acquire images based on the start and stop signal from separate digital IO pulses.

## External Triggers

If you are using external triggering, you can use any of the following methods to trigger your reader.

- Press the ACT button on the reader.



- Send a pulse on the I/O cable.
  - Trigger +
  - Trigger -

**Note:** This method is available on the DataMan 80-PoE by default. You can also use this method DataMan 80-USB when connected through the serial I/O adapter cable.

- Send a trigger command over any serial connection .
- Press **CTRL+T** on the keyboard while the DataMan Setup Tool has the input focus.
- Click the **Trigger** button in the DataMan Setup Tool.

**Note:** You can also initiate external triggering through industrial protocols from a programmable logic controller.

## Training the Reader

Training your reader with the expected symbology can make the time required to decode successive symbols more consistent. In addition, training may help increase decode yield.

To train your reader, place a code in front of the reader and do one of the following:

- Press and hold the ACT button for a minimum of three seconds.



- Click **Train Code** under **Actions** on the ribbon bar.

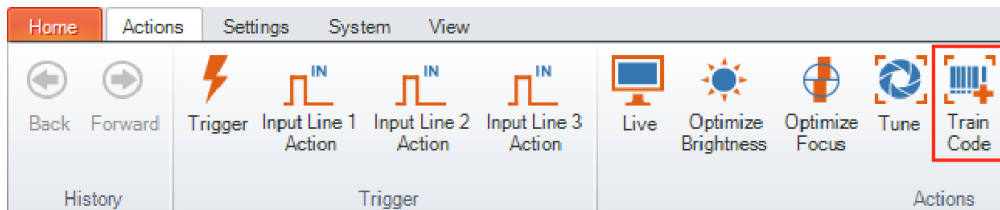

You can use training in **Single**, **Burst**, **Continuous** or **Self** trigger modes.

**Note:** Only a single symbol of each symbology kind can be trained.

## Manual Training

You can manually train your reader which is helpful if you do not have a barcode nearby or you need to train during a running production.

1. Click **Advanced** under the **Code Details**.
2. In the **Training** tab, you can manually train a code by entering the attributes.
3. Check the **Is Valid** checkbox.

Training	
Disable Untrained Symbologies	<input checked="" type="checkbox"/>
Incremental Training	<input type="checkbox"/>
<b>Data Matrix</b>	
Training	Trained <span style="float: right;">Untrain Code</span>
<b>Manual Code Training</b>	
Number of Rows	18
Number of Columns	18
Module Size (pixels)	22.8
Polarity	Dark On Light
Mirrored	<input type="checkbox"/>
Is Valid	<input checked="" type="checkbox"/>

## Training Feedback

The second LED from left on the reader glows green to indicate that it is currently trained. If the reader has no trained code, the LED is off.



Connect the reader to the DataMan Setup Tool to untrain it and allow it to recognize other enabled symbologies.

## Incremental Training for Multiple Symbologies

If you want to train the reader to recognize multiple symbologies, you can present a single image showing all the desired symbologies and perform the training procedure previously described.

If you cannot present a single image showing all the necessary symbologies, you can enable incremental training under **Training** on the **Advanced** tab of the **Code Details** pane:

The screenshot shows the 'Code Details' pane with the 'Advanced' tab selected. The 'Training' section is expanded, and the 'Incremental Training' checkbox is checked and highlighted with a red box. The 'Disable Untrained Symbologies' checkbox is also checked.

Section	Property	Value
General	2D	
	1D	
Multicode	Number of Codes	1
	Allow Partial Results	<input type="checkbox"/>
	Data Matrix	
	QR Code / MaxiCode / Aztec Code	
	DotCode	
1D / Stacked / Postal	Sorting Priority	Symbology.
	Training	
Training	Disable Untrained Symbologies	<input checked="" type="checkbox"/>
	Incremental Training	<input checked="" type="checkbox"/>

With incremental training enabled, you can train the reader using multiple images showing the symbologies you expect to decode. The reader will train each new symbology while retaining the existing trained symbologies.

## Industrial Protocols

**Note:** Only the DM80-PoE supports industrial protocols.

The reader supports the following industrial protocols:

- EtherNet/IP™, EDS and PLC
- PROFINET (Class B)
- SLMP Protocol
- Modbus TCP
- CC-Link

Select industrial protocol samples and tools you want to use when you install the DataMan Setup Tool.

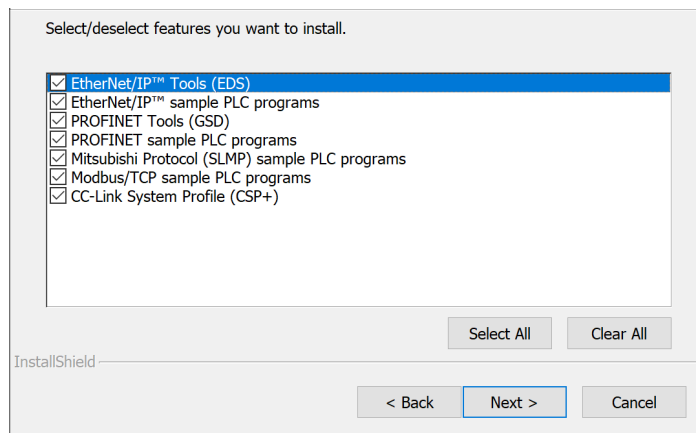

There are three ways to enable or disable industrial protocols. Once enabled, a reboot is required for the changes to take effect.

- Enable the protocols using the **Industrial Protocols** pane of the DataMan Setup Tool, under **Communications**.
- Scan the appropriate **Reader Configuration codes**. For more information, see *Reader Configuration Codes* available through the Windows **Start** menu, the DataMan Setup Tool **Help** menu, or DataMan documentation available on the [Cognex support site](#).
- Send the appropriate **DMCC** command. For more information, see *Command Reference* available through the Windows **Start** menu or the DataMan Setup Tool **Help** menu.

For more information on using the industrial protocols, see the **DataMan Industrial Protocols Manual** available through the Windows **Start** menu, the DataMan Setup Tool **Help** menu, or DataMan documentation available on the [Cognex support site](#).

# Specifications

The following sections list general specifications for the reader.

## DataMan80 Series Reader

Specification	DataMan 80-USB	DataMan 80-PoE
Weight	With 6.2 mm lens: 64 g With 16 mm lens: 97 g	With 6.2 mm lens: 99 g With 16 mm lens: 132 g
Power	<ul style="list-style-type: none"> <li>USB powered:               <ul style="list-style-type: none"> <li>USB BC 1.2 port.</li> <li>USB 3.0 port with 4.5 W or higher.</li> <li>USB-C with USB-PD (5 V/3 A)</li> </ul> </li> <li>External power supply: +5 — +24 V DC.</li> </ul> <div style="border: 1px solid black; padding: 5px; margin-top: 10px;"> <p><b>Note:</b> External power is only available when using a Cognex serial I/O breakout cable, for example CCB-PIO-DB15-05ST.</p> </div> <p>Supplied by limited-energy circuit according to IEC/UL/CSA 61010-1.</p>	PoE Class 2
Power Consumption	Average: 3.3 W Maximum: 4.2 W	Average: 4.3 W Maximum: 6 W
Operating Temperature	0–40 °C (32–104 °F)	
Storage Temperature	-10–60 °C (14–140 °F)	
Humidity	<95% non-condensing	
Environmental	DataMan 80: IP67 <div style="border: 1px solid black; padding: 10px; margin-top: 10px;"> <p><b>Note:</b></p> <ul style="list-style-type: none"> <li>IP67 rating applies only if you attach all blind plugs and cables properly, or install the provided connector plug.</li> <li> The DataMan 80-USB is compatible with 10-pin CAT5 RJ50 cables. When using off-the-shelf cables, the IP rating is based on the rating of your chosen cable.</li> <li>Make sure to install the IP67-rated cover properly.</li> </ul> </div> <p>Altitude: 2000 m, indoor use only, pollution degree II</p>	
Shock	IEC 60068-2-27 - 500 shocks in each polarity of each (X, Y, and Z) axis, 3000 shocks total, semi-sinusoidal, 11 g, 10 ms	
Shock (Shipping and Storage)	ISTA-1A Standardized Testing - Packaged Products 150 lb or less	
Vibration	IEC 60068-2-6: vibration test in each of the three main axis for 2 hours @ 10 Gs (10 to 500 Hz at 100 m/s <sup>2</sup> / 15 mm)	

Specification	DataMan 80-USB	DataMan 80-PoE
Vibration (Shipping and Storage)	FedEx Vibration Testing for packaged products 150 lbs or less	
Codes	<b>1-D barcodes:</b> Codabar, Code 39, Code 128, Code 93, Code 25, Interleaved 2 of 5, Postal Codes, UPC/EAN/JAN, MSI <b>2-D barcodes:</b> Data Matrix (IDMax and IDQuick: ECC 0, 50, 80, 100, 140, and 200), QR Code, microQR, PDF 417, AztecCode, DotCode, MaxiCode	
High-Speed Output 0	<b>Note:</b> Only available when using the <a href="#">Serial I/O Adapter (CCB-PIO-DB15-05ST)</a> on page 48.	<b>Note:</b> The DataMan 80-PoE uses one shared line for input and output.
	$I_{MAX}$ : 50 mA	$I_{MAX}$ : 50 mA
	$V_{OL}$ : $\leq \pm 3$ V @ 50 mA	$V_{OL}$ : $\leq \pm 3$ V @ 50 mA
Input 0	<b>Note:</b> Only available when using the <a href="#">Serial I/O Adapter (CCB-PIO-DB15-05ST)</a> on page 48.	<b>Note:</b> Only available when using the <a href="#">PoE Cable (CCB-PIO-RJ50-2ST)</a> on page 49.
	$V_{IL}$ : $\leq \pm 6$ V	$V_{IL}$ : $\leq \pm 6$ V
	$V_{IH}$ : $\geq \pm 12$ V	$V_{IH}$ : $\geq \pm 12$ V
	$I_{TYP}$ : 4.2 mA @ 24 V	$I_{TYP}$ : 4.2 mA @ 24 V
Ethernet	N/A	10/100/1000. Full duplex or half duplex.
RS-232	RxD, TxD according to TIA/EIA-232-F	N/A
	<b>Note:</b> Only available when using the <a href="#">Serial I/O Adapter (CCB-PIO-DB15-05ST)</a> on page 48.	

## DataMan 80 Series Reader Image Sensor

Specification	DataMan 80
Image Sensor	1/3-inch CMOS, global shutter
Image Sensor Properties	Diagonal size: 6.21 mm Pixel size: 3.45 $\mu$ m (H) x 3.45 $\mu$ m (V)
Image Resolution (pixels)	1440 x 1080 (1.6 mp)
Electronic Shutter Speed	Minimum exposure: 43 $\mu$ s Maximum exposure: 1 ms (with internal illumination) Maximum exposure: 200 ms (with external illumination)
Image Acquisition at Full Resolution	Maximum: 45 Hz
Lens Type	<ul style="list-style-type: none"> <li>6.2 mm (3 pos or LLM) with IR blocking filter</li> <li>16 mm (manual or LLM) with IR blocking filter</li> <li>6.2 mm UV, 6.2 mm</li> <li>16 mm IR</li> </ul>

## LED and Laser Wavelengths

The following table shows LED types and the related peak wavelengths.

PID	LED	Wavelength
DM150-LED-WHT	White	Chromaticity coordinates acc. to CIE 1931 • Cx 0.34 (typ.) • Cy 0.33 (typ.)
DM150-LED-BLU	Blue	465 nm
DM150-LED-RED	Red	617 nm
DMA-KIT-IR-62	IR	820 nm
DMA-KIT-IR-16	IR	850 nm

## Acquisition Trigger Input

The reader features one acquisition trigger input. You can configure the acquisition trigger input to trigger from an NPN (current sinking) device.

To trigger from an NPN type photoelectric sensor or PLC output, connect IN 0 to the output of the photoelectric sensor. The reference of the input is GND. When the output turns ON, it pulls TRIGGER down to 0 VDC, turning the transistor ON.

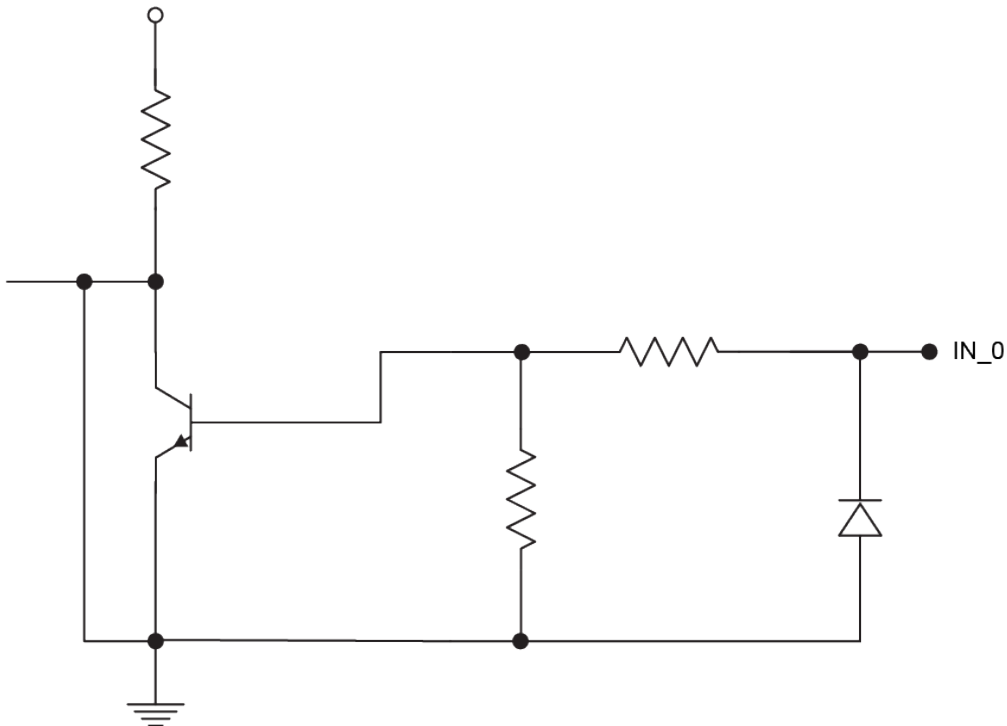

## High-Speed Outputs

Specification	Description
Voltages	$V_{MAX}$ : 26 VDC through external load $V_{OL}$ : $\leq \pm 3$ V @ 50 mA
Current	$I_{MAX}$ : 50 mA maximum sink or source current Each line is protected against over-current, short circuits and transients from switching inductive loads. High current inductive loads require an external protection diode.

For NPN lines, the external load should be connected between the output and the positive supply voltage (< 26 VDC). The output pulls down to less than 3 VDC when ON, which causes current to flow through the load. When the output is OFF, no current flows through the load.

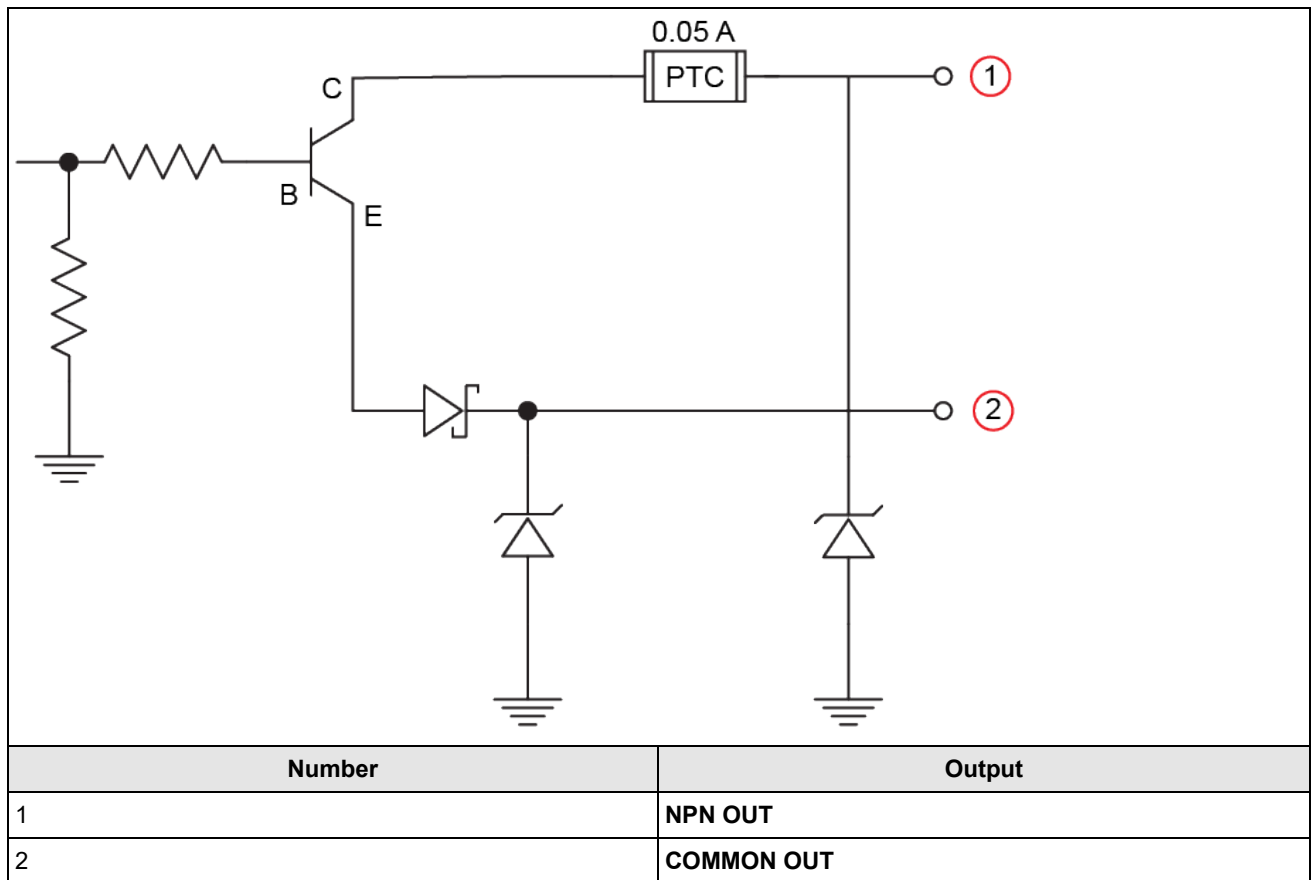

For PNP lines, the external load should be connected between the output and the negative supply voltage (0 VDC). When connected to a 24 VDC power supply, the output pulls up greater than 21 VDC when ON, and current flows through the load. When the output is OFF, no current flows through the load.

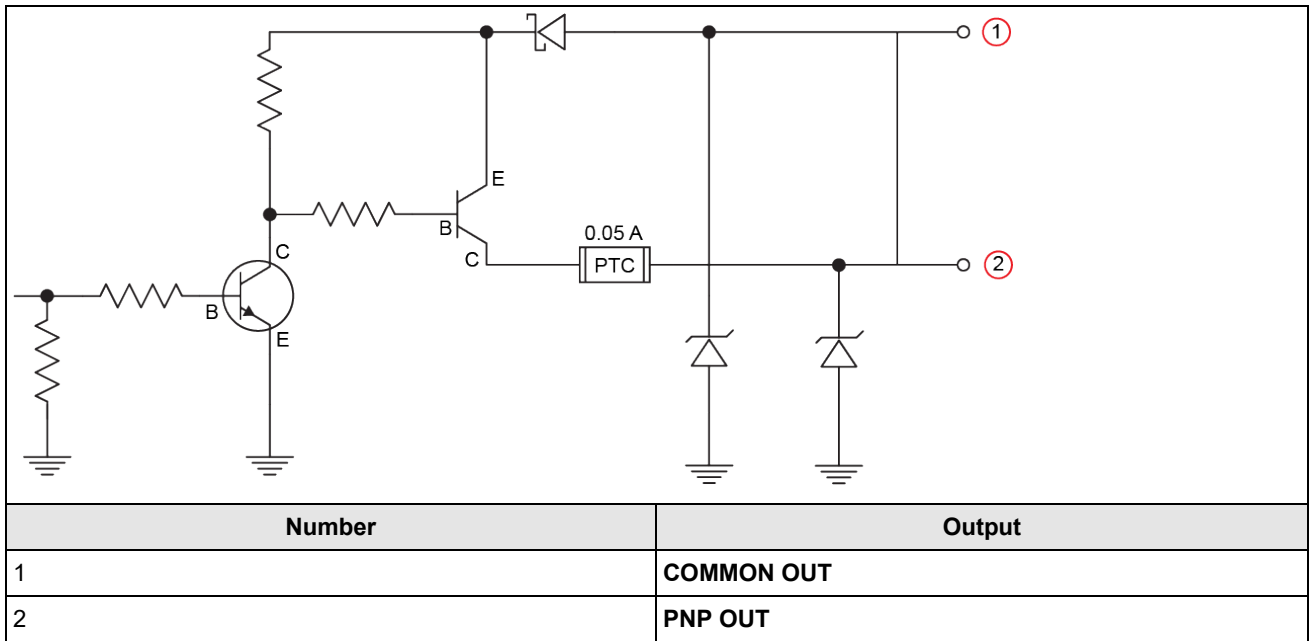

## High Speed Output Wiring

To connect to an NPN-compatible PLC input, connect one of the reader's high-speed outputs directly to the PLC input. When enabled, the output pulls the PLC input down to less than 3 VDC.

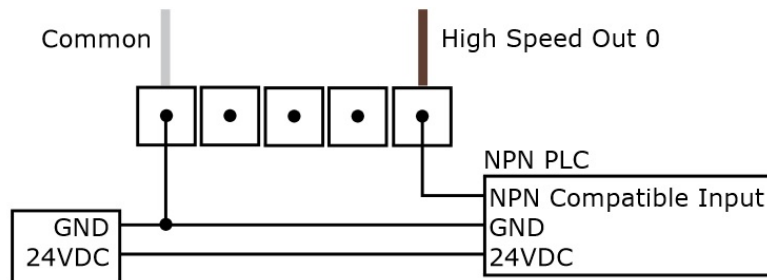

To connect to a PNP-compatible PLC input, connect one of the reader's high-speed outputs directly to the PLC input. When enabled, the output pulls the PLC input up to greater than 21 VDC.

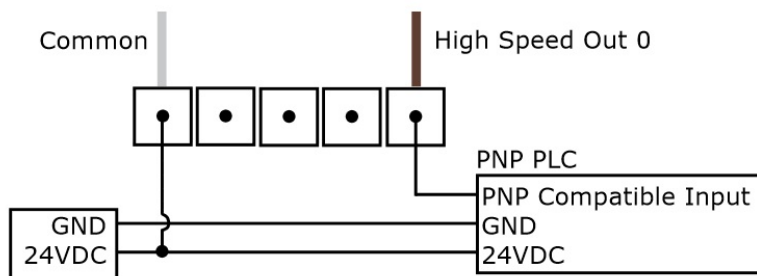

To connect the high-speed outputs to a relay, LED or similar load, connect the negative side of the load to the output and the positive side to +24VDC. When the output switches on, the negative side of the load is pulled down to less than 3 VDC, and 21 VDC appears across the load. Use a protection diode for a large inductive load, with the anode connected to the output and the cathode connected to +24 VDC.

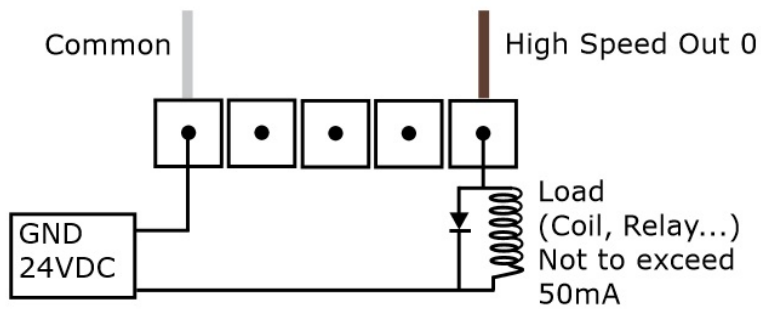

## Serial I/O Adapter (CCB-PIO-DB15-05ST)

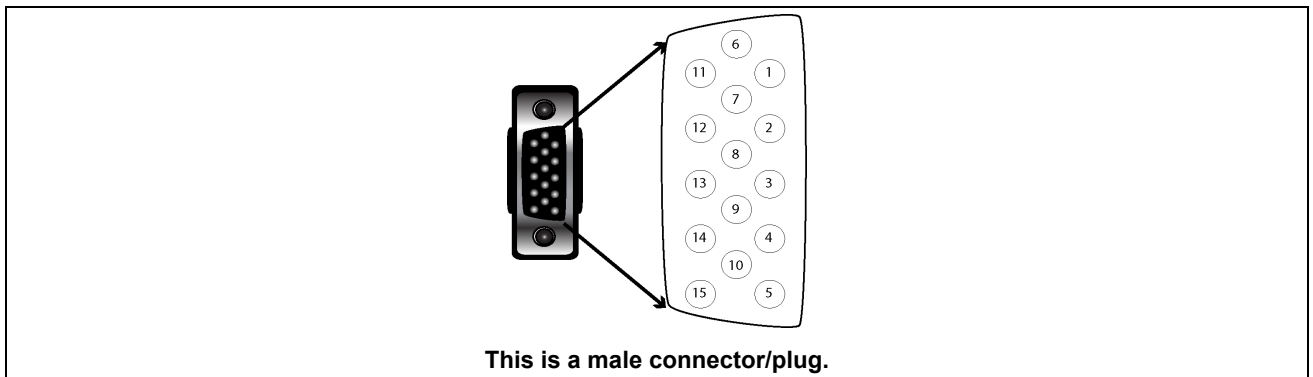

Pin Number	Signal Name
1	Reserved
2	TxD
3	RxD
4	GND
5	DC+ (system power, 5-24 VDC)
6	NC
7	Output-0
8	Input-0
9	NC
10	NC
11	NC
12	Output-Common
13	NC
14	Reserved
15	Reserved

## PoE Cable (CCB-PIO-RJ50-2ST)

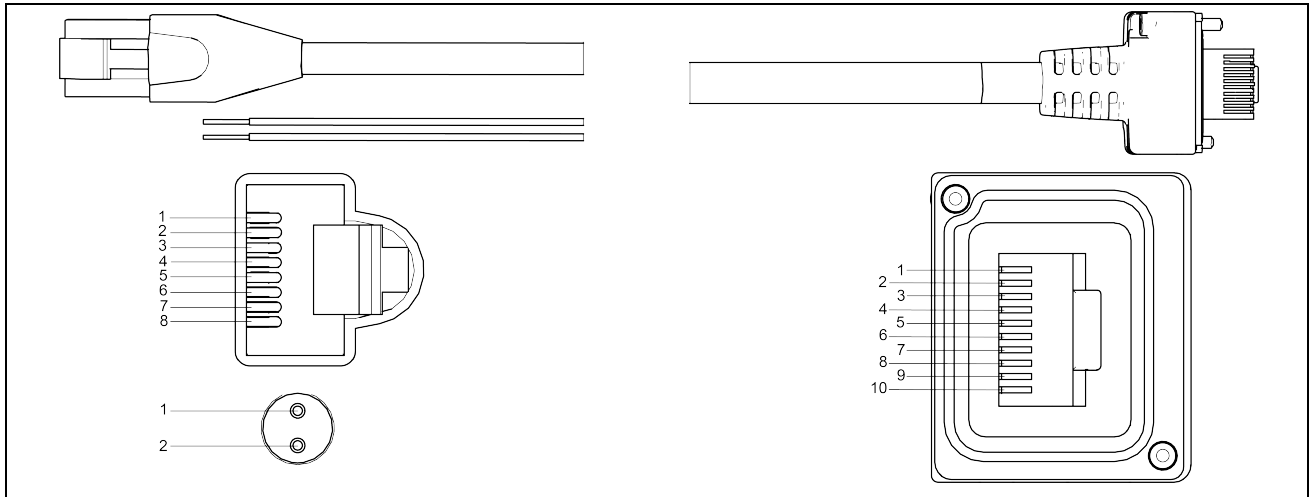

RJ45 Jack				RJ50 Jack			
Pin Number	Color	Twisted Pair	Function	Pin Number	Color	Twisted Pair	Function
1	Green/White	3	Ethernet	2	Green/White	3	Ethernet
2	Green	3		3	Green/White	3	
3	Orange/White	2		4	Orange/White	2	
4	Blue	1		5	Blue	1	
5	Blue/White	1		6	Blue/White	1	
6	Orange	2		7	Orange	2	
7	Brown/White	4		8	Brown/White	4	
8	Brown	4		9	Brown	4	
Flying Leads				Outer Pins			
1	Purple	None	In/Out	1	Purple	None	In/Out
2	Purple/White	None	Common	10	Purple/White	None	Common

## I/O Cable (DM-USBIO-00)

You can connect a cable with USB and flying leads to the cable that is attached to the DataMan 80-USB. The following table shows the pinout and color description of the flying leads. The leads not shown in the table are not connected to the device.

**Note:** GND (Pin 4) is connected to the reader housing, cable shield, and DB15 shell.

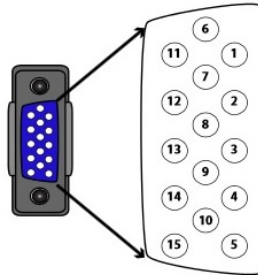

This is a female socket/connector.

PIN	Color	Signal
4	Black	GND
7	Blue/White	Output-0
8	White	Input-0
12	Light Blue/Yellow	Output-Common

## RS-232 Cable (DM-RS232IO-00)

You can connect a cable with RS-232 and flying leads to the cable that is attached to the DataMan 80-USB. The following table shows the pinout and color description of the flying leads. The leads not shown in the table are not connected to the device.

**Note:** The DataMan 80-USB does not support flow control through RS-232.

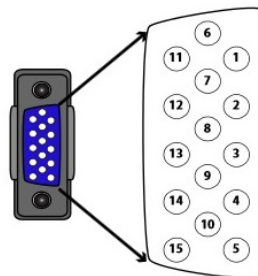

This is a female socket/connector.

PIN	Color	Signal
4	Black	GND
5	Brown/White	VDC
7	Blue/White	Output-0
8	White	Input-0
12	Light Blue/Yellow	Output-Common
13	Light Blue/Green	Input-Common

# Cleaning and Maintenance

## Clean the Housing

To clean the outside of the reader housing, use a small amount of mild detergent cleaner or isopropyl alcohol on a cleaning cloth. Do not pour the cleaner on the reader housing.

---

 **CAUTION:** Do not attempt to clean any DataMan product with harsh or corrosive solvents, including lye, methyl ethyl ketone (MEK) or gasoline.

---

## Clean the Reader Image Sensor Window

To remove dust from the outside of the image sensor window, use a pressurized air duster. The air must be free of oil, moisture or other contaminants that could remain on the glass and possibly degrade the image. Do not touch the glass window. If oil or smudges remain, use a cotton bud and alcohol (ethyl, methyl, or isopropyl) to clean the window. Do not pour the alcohol on the window.



## Clean the Reader Lens Cover

To remove dust from the lens cover, use a pressurized air duster. The air must be free of oil, moisture or other contaminants that could remain on the lens cover. To clean the plastic window of the lens cover, use a small amount of isopropyl alcohol on a cleaning cloth. Do not scratch the plastic window. Do not pour the alcohol on the plastic window.

# Regulations and Conformity

**Note:** For the most current CE and UKCA declarations and regulatory conformity information, see the Cognex support site: [cognex.com/support](http://cognex.com/support).

DataMan 80 readers have Regulatory Model numbers 50209 and 50181 and meet or exceed the requirements of all applicable standards organizations for safe operation. However, as with any electrical equipment, the best way to ensure safe operation is to operate them according to the agency guidelines that follow. Please read these guidelines carefully before using your device.

<b>Safety and Regulatory</b>	
Manufacturer	Cognex Corporation One Vision Drive Natick, MA 01760 USA
	DataMan 80-USB: Regulatory Model 50209 DataMan 80-PoE: Regulatory Model 50181 This is a class A product. In a domestic environment this product may cause radio interference in which case the user may be required to take immediate measures. This equipment complies with the essential requirements of the EU Directive 2014/30/EU. Declarations are available from your local representative.
EU RoHS	Compliant to the most recent applicable directive.
FCC	FCC Part 15, Class A This equipment has been tested and found to comply with the limits for a Class A digital device, pursuant to part 15 of the FCC Rules. These limits are designed to provide reasonable protection against harmful interference when the equipment is operated in a commercial environment. This equipment generates, uses, and can radiate radio frequency energy and, if not installed and used in accordance with the instruction manual, may cause harmful interference to radio communications. Operation of this equipment in a residential area is likely to cause harmful interference in which case the user will be required to correct the interference at his own expense.
Korea 	This device is certified for office use only and if used at home, there can be frequency interference problems. A급 기기(업무용 방송통신기자재): 이 기기는 업무용(A급) 전자파적합기기로서 판매자 또는 사용자는 이 점을 주의하시기 바라며, 가정외의 지역에서 사용하는 것을 목적으로 합니다. DataMan 80-USB: R-R-CGX-50209 DataMan 80-PoE: R-R-CGX-50181
TÜV	DataMan 80-USB: Regulatory Model 50209 DataMan 80-PoE: Regulatory Model 50181 NRTL: TÜV SÜD SCC/NRTL OSHA Scheme for UL/CAN 61010-1. CB report available upon request. TÜV SÜD, IEC/EN 61010-1.
UK	Regulatory Model 50209 Regulatory Model 50181 This is a class A product. In a domestic environment, this product can cause radio interference, in which case the user is required to take adequate measures. This equipment complies with the essential requirements of the Electromagnetic Compatibility Regulations 2016. Declarations are available from your local representative.

## 中国大陆RoHS (Information for China RoHS Compliance)

根据中国大陆《电子信息产品污染控制管理办法》(也称为中国大陆RoHS), 以下部份列出了本产品中可能包含的有毒有害物质或元素的名称和含量。



Part Name 部件名称	Hazardous Substances 有害物质					
	Lead (Pb) 铅	Mercury (Hg) 汞	Cadmium (Cd) 镉	Hexavalent Chromium (Cr (VI)) 六价铬	Polybrominated biphenyls (PBB) 多溴联苯	Polybrominated diphenyl ethers (PBDE) 多溴二苯醚
Regulatory Model 50209 Regulatory Model 50181	X	O	O	O	O	O

This table is prepared in accordance with the provisions of SJ/T 11364.

这个标签是根据SJ/T 11364 的规定准备的。

O: Indicates that said hazardous substance contained in all of the homogeneous materials for this part is below the limit requirement of GB / T26572 - 2011.

表示本部件所有均质材料中含有的有害物质低于GB / T26572 - 2011 的限量要求。

X: Indicates that said hazardous substance contained in at least one of the homogeneous materials used for this part is above the limit requirement of GB / T26572 - 2011.

表示用于本部件的至少一种均质材料中所含的危害物质超过GB / T26572 - 2011 的限制要求。

## For European Community Users

Cognex complies with Directive 2012/19/EU OF THE EUROPEAN PARLIAMENT AND OF THE COUNCIL of 4 July 2012 on waste electrical and electronic equipment (WEEE).

This product has required the extraction and use of natural resources for its production. It may contain hazardous substances that could impact health and the environment, if not properly disposed.

In order to avoid the dissemination of those substances in our environment and to diminish the pressure on the natural resources, we encourage you to use the appropriate take-back systems for product disposal. Those systems will reuse or recycle most of the materials of the product you are disposing in a sound way.



The crossed out wheeled bin symbol informs you that the product should not be disposed of along with municipal waste and invites you to use the appropriate separate take-back systems for product disposal.

If you need more information on the collection, reuse, and recycling systems, please contact your local or regional waste administration.

You may also contact your supplier for more information on the environmental performance of this product.

