

DataMan[®] 280 Series Reference Manual



2024 January 04
Revision: 24.1.0.4

Legal Notices

The software described in this document is furnished under license, and may be used or copied only in accordance with the terms of such license and with the inclusion of the copyright notice shown on this page. Neither the software, this document, nor any copies thereof may be provided to, or otherwise made available to, anyone other than the licensee. Title to, and ownership of, this software remains with Cognex Corporation or its licensor. Cognex Corporation assumes no responsibility for the use or reliability of its software on equipment that is not supplied by Cognex Corporation. Cognex Corporation makes no warranties, either express or implied, regarding the described software, its merchantability, non-infringement or its fitness for any particular purpose.

The information in this document is subject to change without notice and should not be construed as a commitment by Cognex Corporation. Cognex Corporation is not responsible for any errors that may be present in either this document or the associated software.

Companies, names, and data used in examples herein are fictitious unless otherwise noted. No part of this document may be reproduced or transmitted in any form or by any means, electronic or mechanical, for any purpose, nor transferred to any other media or language without the written permission of Cognex Corporation.

Copyright © 2023. Cognex Corporation. All Rights Reserved.

Portions of the hardware and software provided by Cognex may be covered by one or more U.S. and foreign patents, as well as pending U.S. and foreign patents listed on the Cognex web site at: cognex.com/patents.

The following are registered trademarks of Cognex Corporation:

Cognex, 2DMAX, Advantage, AlignPlus, Assemblyplus, Check it with Checker, Checker, Cognex Vision for Industry, Cognex VSOC, CVL, DataMan, DisplayInspect, DVT, EasyBuilder, Hotbars, IDMax, In-Sight, Laser Killer, MVS-8000, OmniView, PatFind, PatFlex, PatInspect, PatMax, PatQuick, SensorView, SmartView, SmartAdvisor, SmartLearn, UltraLight, Vision Solutions, VisionPro, VisionView

The following are trademarks of Cognex Corporation:

The Cognex logo, 1DMax, 3D-Locate, 3DMax, BGAll, CheckPoint, Cognex VSoC, CVC-1000, FFD, iLearn, In-Sight (design insignia with cross-hairs), In-Sight 2000, InspectEdge, Inspection Designer, MVS, NotchMax, OCRMax, PatMax RedLine, ProofRead, SmartSync, ProfilePlus, SmartDisplay, SmartSystem, SMD4, VisiFlex, Xpand

Portions copyright © Microsoft Corporation. All rights reserved.

Portions copyright © MadCap Software, Inc. All rights reserved.

Other product and company trademarks identified herein are the trademarks of their respective owners.

Precautions

To reduce the risk of injury or equipment damage, observe the following precautions when you install the Cognex product:

- Connectivity is possible through the following options:
 - 24 VDC (+/- 10%) output connection using a UL or NTRL listed power supply
 - Power over Ethernet (PoE) 13 W power supply

Any other voltage creates a risk of fire or shock and can damage the components. Applicable national and local wiring standards and rules must be followed.

- This product is intended for industrial use in automated manufacturing or similar applications.
- The safety of any system incorporating this product is the responsibility of the assembler of the system.
- Do not install Cognex products where they are exposed to environmental hazards such as excessive heat, dust, moisture, humidity, impact, vibration, corrosive substances, flammable substances, or static electricity.
- Route cables and wires away from high-current wiring or high-voltage power sources to reduce the risk of damage or malfunction from the following causes: over-voltage, line noise, electrostatic discharge (ESD), power surges, or other irregularities in the power supply.
- Do not expose the image sensor to laser light. Image sensors can be damaged by direct, or reflected, laser light. If your application requires laser light that might strike the image sensor, use a lens filter at the corresponding laser wavelength. For suggestions, contact your local integrator or application engineer.
- This product does not contain user-serviceable parts. Do not make electrical or mechanical modifications to product components. Unauthorized modifications can void your warranty.
- Changes or modifications not expressly approved by the party responsible for regulatory compliance could void the user's authority to operate the equipment.
- Include service loops with cable connections.
- Ensure that the cable bend radius begins at least six inches from the connector. Cable shielding can be degraded or cables can be damaged or wear out faster if a service loop or bend radius is tighter than 10X the cable diameter.
- This device should be used in accordance with the instructions in this manual.
- All specifications are for reference purposes only and can change without notice.

Symbols

The following symbols indicate safety precautions and supplemental information:

 **WARNING:** This symbol indicates a hazard that could cause death, serious personal injury or electrical shock.

 **CAUTION:** This symbol indicates a hazard that could result in property damage.

 **Note:** This symbol indicates additional information about a subject.

 **Tip:** This symbol indicates suggestions and shortcuts that might not otherwise be apparent.

Table of Contents

Legal Notices	2
Precautions	3
Symbols	4
Table of Contents	5
Getting Started	7
About the DataMan 280 Series	7
Supporting Documentation	8
DataMan 280 Series Accessories	9
Lenses	9
Illumination	10
Lens Covers	11
Mounting Brackets	12
Cables	13
DataMan 280 Series Systems	14
DataMan 280 Systems	14
DataMan 282 Systems	15
Illumination Options	15
Setting Up Your DataMan Reader	17
Reader Layout	17
Indicator LEDs	19
Dimensions	21
DataMan 280 with 6.2 mm lens	21
DataMan 280 with 16 mm Lens	22
DataMan 280 with L-shaped extension, equipped with 6.2 mm Lens	23
DataMan 280 with L-shaped extension, equipped with 16 mm Lens	24
DataMan 282 with High Power Integrated Torch	25
DataMan 282 with High Power Integrated Torch - L-Shaped Extension	26
Dataman 282 with Dome Front Cover	27
Dataman 282 with Dome Front Cover - Right Angle Configuration	28
Field of View and Reading Distance	29
DataMan 280 Readers with 6.2 mm Lens	29
Short Range (Focused to 105 mm)	29
Long Range (Focused to 190 mm)	29
DataMan 280 Readers with 16 mm lens	30
DataMan 282 Readers with 8 mm Lens	32
DataMan 282 Readers with 12 mm Lens	33
DataMan 282 Readers with 16 mm Lens	34
Connecting the Reader	35
Installing and Changing Lenses	36
Installing a C-Mount Lens	36
Changing a 6.2 mm Lens to a 16 mm Lens	40
Installing a High Speed Liquid Lens	44
Installing Front Cover on High-Power Integrated Torch	48

Mounting the Reader	48
Mounting the Reader in Straight Configuration	49
Mounting the Reader in Right-Angle Configuration	49
Setting Focus	49
Manual Focus Lens	50
Focus Feedback	51
Best Practices	51
Connection Options	53
Connecting the Ethernet Cable to DataMan 280 Series Readers	53
DataMan 282 Readers LED Behavior with PoE	53
Connecting the Power and I/O Breakout Cable	53
Using your Device through USB	53
Emulating Serial Functionality	54
Emulating Ethernet Functionality	54
USB-Keyboard (HID) Functionality	55
Using Your DataMan Reader	57
Installing the DataMan Setup Tool	57
Trigger Types	57
External Triggers	58
Training the Reader	58
Manual Training	59
Training Feedback	60
Incremental Training for Multiple Symbologies	60
DM282 LED Configurations	61
Industrial Protocols	64
Specifications	65
DataMan 280 Series Reader	65
DataMan 280 Series Reader Image Sensor	66
LED Wavelengths	66
Acquisition Trigger Input	67
High-Speed Outputs	68
High Speed Output Wiring	69
Ethernet Cable	70
CCB-M12x12Fy-xx	71
CCBL-05-01	72
CCB-PWRIO-05	73
Cleaning and Maintenance	74
Clean the Housing	74
Clean the Reader Image Sensor Window	74
Clean the Reader Lens Cover	74
Regulations and Conformity	75
中国大陆RoHS (Information for China RoHS Compliance)	76
For European Community Users	76

Getting Started

This section provides general information about the DataMan 280 series reader and the accessories and systems.

About the DataMan 280 Series

The DataMan 280 series readers are high-performance readers that offer:

- Premium class performance in a compact package
- Flexible Industry 4.0 connectivity options
- Unmatched Modularity and Ease of Use

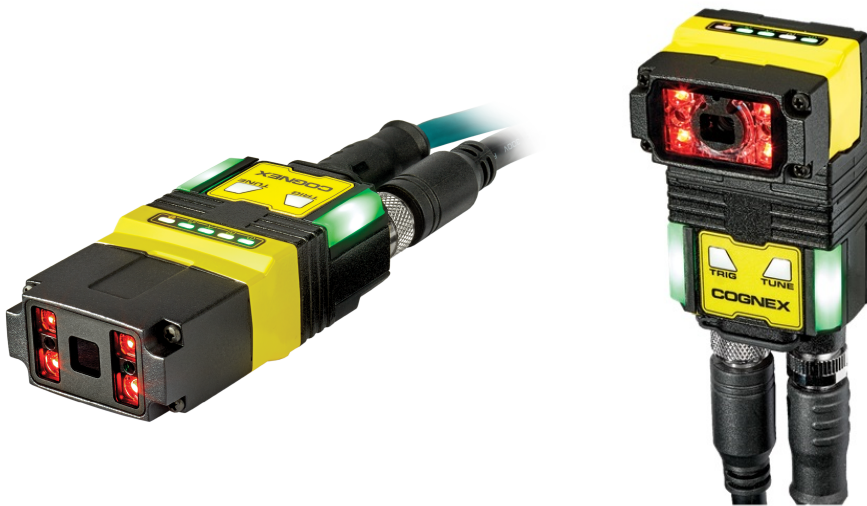

Supporting Documentation

This document provides basic information about the DataMan 280 series readers. Additional information is available through the Windows **Start** menu or the DataMan Setup Tool **Help** menu after you install the DataMan software on your PC.





Note: For the latest documentation, visit: support.cognex.com/documentation/dataman.

- The **DataMan Communications and Programming Guide** shows you how to integrate your DataMan reader into your particular automation and factory environment.
Cognex > DataMan Software Revision: x.x.x> Documentation > Communications > DataMan Communications and Programming Guide
- The **DataMan Industrial Protocols Manual** provides information on how to integrate DataMan readers into your particular environment using industrial protocols.
Cognex > DataMan Software Revision: x.x.x> Documentation > Communications > DataMan Industrial Protocols Manual
- The **DataMan Reader Configuration Codes** document provides printable 2-D codes that you can use to configure the DataMan reader.
Cognex > DataMan Software Revision: x.x.x > Documentation > English > Reader Configuration Codes
- The **DM280 Quick Reference Guide** provides essential information about the DM280 reader.
Cognex > DataMan Software Revision: x.x.x > Documentation > English > DM280 Series > DM280 Quick Reference Guide
- The **DataMan Fixed-Mount Readers Reference** is a complete online hardware reference for the DataMan fixed-mount ID readers.
Cognex > DataMan Software Revision: x.x.x > Documentation > English > DM280 > Fixed-Mount Reference Manual
- The **DataMan Questions and Answers** document provides context-sensitive information. You can view this help inside the DataMan Setup Tool or as a stand-alone help file.
Cognex > DataMan Software Revision: x.x.x > Documentation > DM280 > Questions and Answers
- The **DataMan Control Commands** lists DataMan Control Commands with all relevant information. You can view this help inside the Setup Tool or as a stand-alone help file.
Cognex > DataMan Software Revision: x.x.x > Documentation > English > DataMan Control Commands
- The **Setup Tool Reference Manual** describes the user interface of the DataMan Setup Tool software.
Cognex > DataMan Software Revision: x.x.x> Documentation > English > Setup Tool Reference Manual
- The **Release Notes** list detailed system requirements and additional information about the DataMan software release.
Cognex > DataMan Software Revision: x.x.x > Documentation > DataMan Revision: x.x.x > Release Notes

DataMan 280 Series Accessories

You can purchase the following components separately. For a list of options and accessories, contact your local Cognex sales representative.

Lenses

Accessory	Product Number	Illustration	DM280	DM282
6.2 mm lens kit that includes: <ul style="list-style-type: none"> • 6.2 mm optics mount • 6.2 mm lens • Manual lens cap (assembled) • Screws 	DM280-LENS-62		✓	
UV Light Kit for 6.2 mm lens <ul style="list-style-type: none"> • UV light board (365 nm wavelength) • UV resistant front cover • screws 	DM280-UV365-62		✓	
16 mm lens kit with extended optics mount (requires the use of an extended front cover and high-powered red LED). The kit includes: <ul style="list-style-type: none"> • 16 mm optics mount • 16 mm lens • Manual lens cap (assembled) • Screws 	DM260-LENS-16		✓	
IR 6.2 mm lens kit, 3-position with IR LED includes: <ul style="list-style-type: none"> • 6.2 mm optics mount • 6.2 mm lens (IR) • Standard Infrared Light for 6.2mm (Risk Group Exempt acc. IEC62471) • Manual lens cap (not assembled) • Screws 	DM280-KIT-IR-62		✓	
IR 16 mm lens kit that includes: <ul style="list-style-type: none"> • 16 mm optics mount • 16 mm lens (IR) • Standard Infrared Light for 16mm (Risk Group Exempt acc. IEC62471) • Manual lens cap (assembled) • Screws 	DMA-KIT-IR-16		✓	

Accessory	Product Number	Illustration	DM280	DM282
High Speed Liquid Lens Module (HSLL) to be used with 6.2 mm lens or 16 mm lens	DMA-HSLL-280		✓	✓
16 mm lens with ImageMax kit that includes: <ul style="list-style-type: none"> • 16 mm optics mount • 16 mm lens • High Speed Liquid Lens Module (DMA-HSLL-280) • High Powered red LED illumination (DM260-LED-RED-HP) (Risk Group Exempt acc. IEC62471) • 2-LED half-polarized extended cover (DM260-LENS-16CVR-P) (Risk Group Exempt acc. IEC62471) 	DM280-KIT-IMGMAX		✓	
Blue bandpass filter	DM150-BP470		✓	
Blue bandpass filter, 450 nm	280-TORCH-BP450			✓
Red bandpass filter	DM150-BP635		✓	
Red bandpass filter, 635 nm	280-TORCH-BP635			✓

Illumination

Accessory	Product Number	Illustration	DM280	DM282
Red LED Light for 6.2 mm Lens (Risk Group Exempt acc. IEC 62471)	DM150-LED-RED		✓	
White LED Light for 6.2 mm Lens (Risk Group Exempt acc. IEC 62471)	DM150-LED-WHT		✓	
Blue LED Light for 6.2 mm Lens (Risk Group Exempt acc. IEC 62471)	DM150-LED-BLU		✓	
High-Powered Red LED Light for 16 mm Lens (Risk Group Exempt acc. IEC 62471) For maximum light power 24 V DC supply is recommended.	DM280-LED-RED-HP		✓	
High-Powered White LED Light for 16 mm Lens (Risk Group Exempt acc. IEC 62471) For maximum light power 24 V DC supply is recommended.	DM280-LED-WHT-HP		✓	





Lens Covers

Accessory	Product Number	Illustration	DM280	DM282
Standard front cover. Use with a 6.2 mm lens only.	DM280-CVR-62		✓	
Standard front cover, half-polarized. Use with a 6.2 mm lens only.	DM280-LENS-62CVR-P		✓	
Standard front cover, fully-polarized. Use with a 6.2 mm lens only.	DM280-LENS-62CVR-F		✓	
Extended front cover. Use with a 16 mm lens only.	DM260-LENS-16CVR		✓	
Extended front cover, half-polarized. Use with a 16 mm lens only.	DM260-LENS-16CVR-P		✓	
Extended front cover, fully-polarized. Use with a 16 mm lens only.	DM260-LENS-16CVR-F		✓	
C-mount adapter, IP40	DM280-CMNT-00		✓	
C-mount cover, IP65	DM280-CMNT-CVR		✓	
Cross-polarized cover for High-Power Integrated Torch	280-HPIT-COVPOL			✓
Clear cover for High-Power Integrated Torch	280-HPIT-COVCLR			✓
Diffuse cover for High-Power Integrated Torch	280-HPIT-COVDIF			✓
Dome Diffuser cover for High-Power Integrated Torch	280-TORCH-DOME			✓

CAUTION: For 280-HPIT-COVPOL, 280-HPIT-COVCLR, and 280-HPIT-COVDIF equipped with a laser aimer, the device has been tested to be under the limits of a Class 1 Laser device.



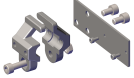









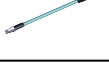

Mounting Brackets

Accessory	Product Number	Illustration	DM280	DM282
Universal mounting bracket	DM100-UBRK-000		✓	✓
Pivot mounting bracket	DM100-PIVOTM-01		✓	✓
Tilted angle pivot bracket	DMBK-DMPIVOT-00		✓	✓
Logistics mounting bracket and plate kit	DMA-BKT-LGS		✓	✓
Adjustable mirror bracket	DMA-262-MIR		✓	

Cables

Note: Cables are sold separately.

Accessory	Product Number	Illustration	DM280	DM282
Ethernet Cable, X-coded M12-8 to RJ-45	CCB-84901-2001-xx (straight, xx specifies length: 2m, 5m, 10m, 15m, 30m)		✓	✓
Ethernet Cable, X-coded M12-8 to RJ-45	CCB-84901-2002-xx (right-angled, xx specifies length: 2m, 5m, 10m)		✓	✓
Ethernet Cable, Robotic X-Coded M12-8 to RJ-45	CCB-84901-2RBT-xx (straight, xx specifies length: 2m, 5m, 10m)		✓	✓
X-Coded to A-Coded Ethernet cable adapter, 0.5 m	CCB-M12X8MS-XCAC		✓	✓
Power and I/O Breakout Cable, M12-12 to Flying Lead	CCB-M12x12Fy-05 (y = straight/angled, xx specifies length)		✓	✓
Power and I/O Breakout Cable, M12-12 to Flying Lead	CCBL-05-01		✓	✓
Power and I/O Breakout Cable, M12-12 to Flying Lead	CCB-PWRIO- xx (straight, xx specifies length: 5m, 10m, 15m)		✓	✓
Power and I/O Breakout Cable, M12-12 to Flying Lead	CCB-PWRIO-xxR (right-angled, xx specifies length: 5m, 10m, 15m)		✓	✓
I/O Module Cable M12-12 to DB15	CCB-PWRIO-MOD-xx (xx specifies length: 2m, 5m)		✓	✓
RS-232 Connection Cable	CCB-M12xDB9Y-05		✓	✓
I/O Extension Cable	CKR-200-CBL-EXT		✓	✓
Sealed USB Type C Cable to USB Type A, Straight, 2.5 m	DMA-STCBL-IP65-25		✓	✓
Sealed USB Type C Cable to USB Type A, Straight 3.6 m	DMA-STCBL-IP65-36		✓	✓
Sealed USB Type C Cable to USB Type A, Angled, 2.5 m	DMA-RTCBL-IP65-25		✓	✓
Sealed USB Type C Cable to USB Type A, Angled, 3.6 m	DMA-RTCBL-IP65-36		✓	✓

DataMan 280 Series Systems



DataMan 280 Systems





	Omni-directional 1D Code	1D Max with Hotbars	High Speed Decoding	2DMax - Hard to read 2D codes	PowerGrid - Damaged 2D codes	Multi-Reader Sync	Resolution
DM-280L 1D Codes		✓	✓			✓	1440 x 1080
DM-280QL 1D Codes	✓	✓	✓			✓	
DM-280S 1D/2D Codes	✓	✓				✓	
DM-280Q 1D/2D Codes	✓	✓	✓	✓		✓	
DM-280X 1D/2D Codes	✓	✓	✓	✓	✓	✓	

DataMan 282 Systems

	Omnidirectional 1D Code	1D Max with Hotbars	High Speed Decoding	2DMax - Hard to read 2D codes	PowerGrid - Damaged 2D codes	Multi-Reader Sync	Resolution
DM-282L 1D Codes		✓	✓			✓	1920 x 1080
DM-282QL 1D Codes	✓	✓	✓			✓	
DM-282S 1D/2D Codes	✓	✓				✓	
DM-282Q 1D/2D Codes	✓	✓	✓	✓		✓	
DM-282X 1D/2D Codes	✓	✓	✓	✓	✓	✓	

Illumination Options

Illumination Board	PoE Powered		24 V Externally Powered	
	Max. exposure time	Max. duty cycle	Max. exposure time	Max. duty cycle
Standard Red 	1 ms	6%	1 ms	6%
High Power Red 	1 ms	6%	10 ms	10%
Standard White 	1 ms	6%	1 ms	6%

Illumination Board	PoE Powered		24 V Externally Powered	
	Max. exposure time	Max. duty cycle	Max. exposure time	Max. duty cycle
High Power White 	1 ms	6%	10 ms	10%
Standard Blue 	1 ms	6%	1 ms	6%
IR 	1 ms	6%	1 ms	6%
High Power IR 	1 ms	6%	10 ms	10%
High-Power Integrated Torch 	HPIT does not support PoE.		5 ms	6.5%

Setting Up Your DataMan Reader

Read this section to learn how the reader connects to its standard components and accessories.

Note:



- Cables are sold separately.
- If a standard component is missing or damaged, immediately contact your Cognex Authorized Service Provider (ASP) or Cognex Technical Support.



CAUTION: All cable connectors are keyed to fit the connectors on the reader. Do not force the connections or damage may occur.

Reader Layout

The images and tables below show the elements of the reader.

DataMan 280:

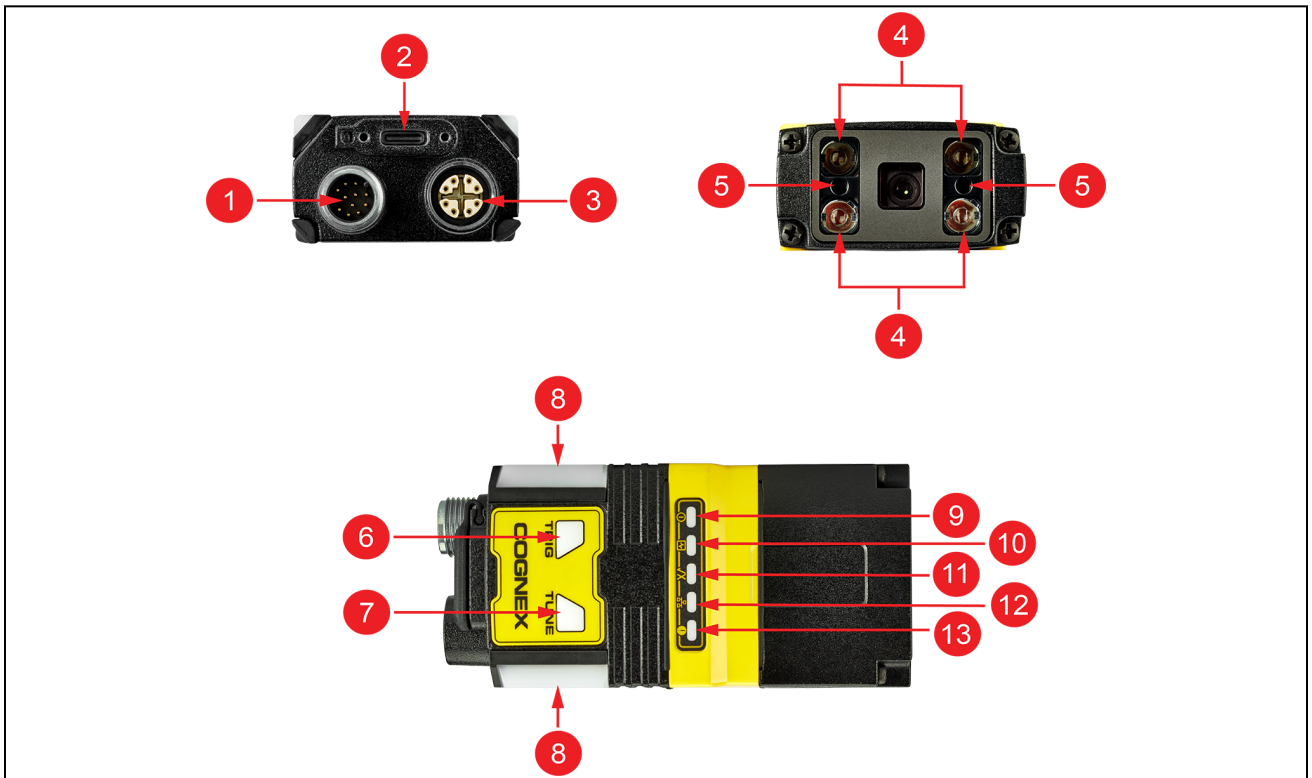

Number	Description
1	Power I/O Breakout cable connector
2	USB-C slot (with plastic cover)
3	Ethernet connector
4	Illumination LEDs
5	LED aimers
6	Trigger button

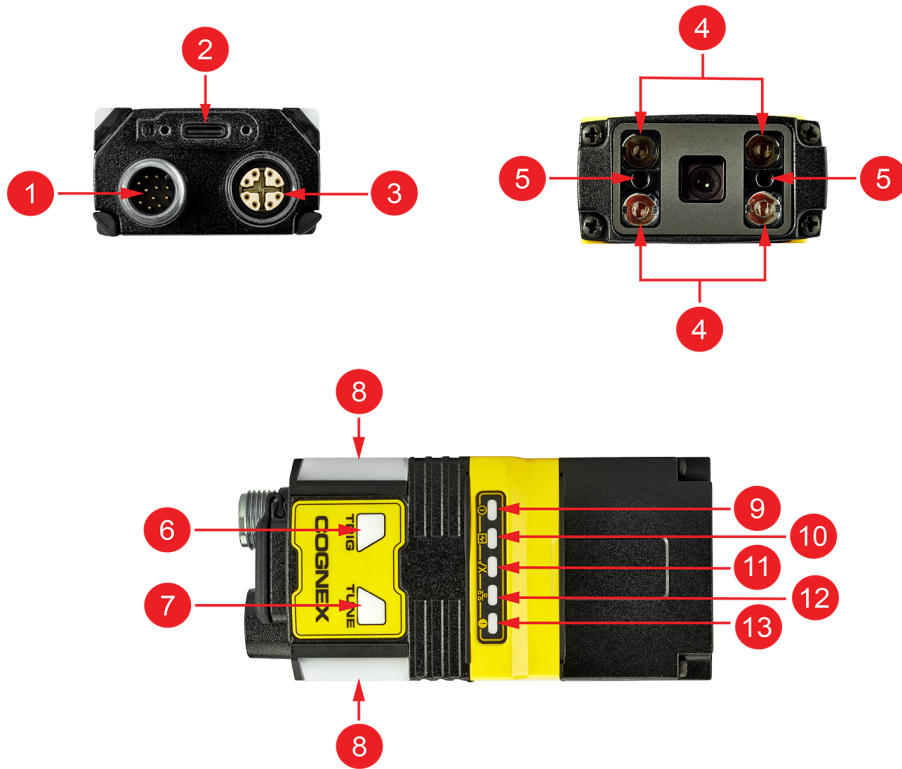

Number	Description
7	Tune button
8	Indicator LEDs
9	Power LED indicator
10	Train status/Trigger status LED indicator
11	Good/bad read LED indicator
12	Communication LED indicator
13	Error LED indicator

DataMan 282:

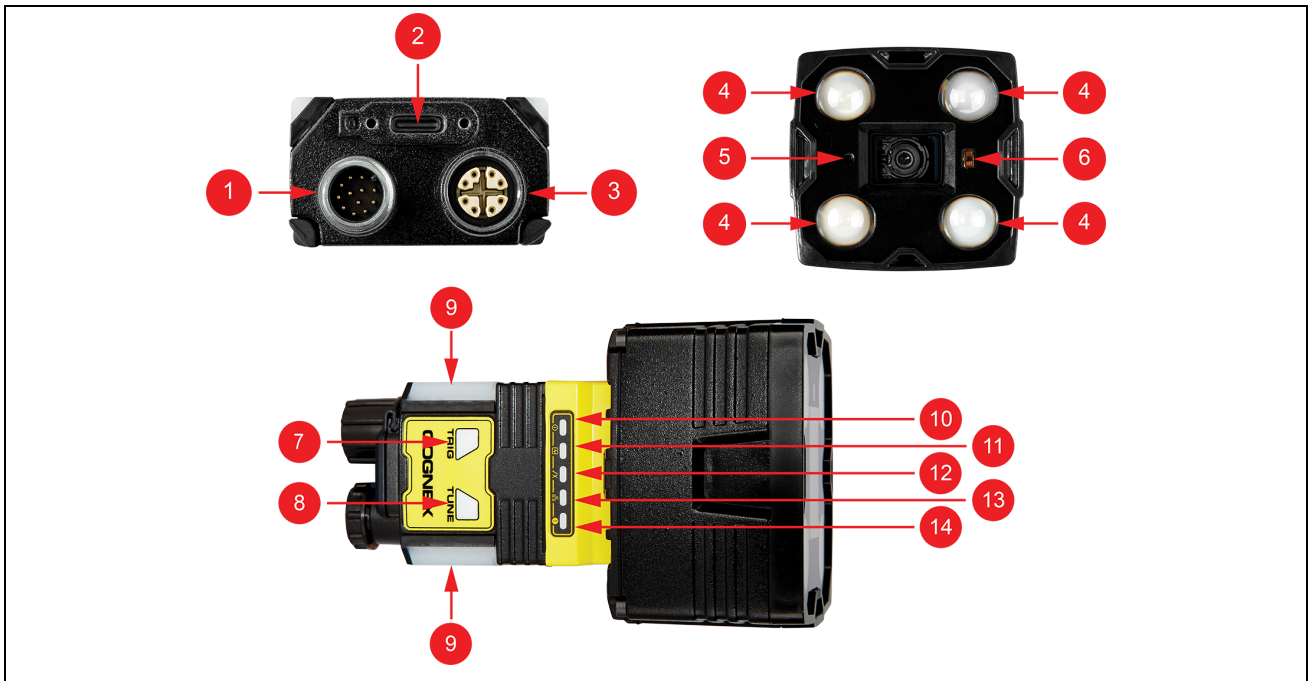

Number	Description
1	Power I/O Breakout cable connector
2	USB-C slot (with plastic cover)
3	Ethernet connector
4	Illumination LEDs
5	LED Aimer
6	Distance Sensor
7	Trigger button
8	Tune button
9	Indicator LEDs
10	Power LED indicator
11	Train status/Trigger status LED indicator
12	Good/bad inspection LED indicator
13	Communication LED indicator
14	Error LED indicator

Indicator LEDs

The table summarizes the functions of the indicator LEDs on DataMan 280 series readers.

Indicator	Color/Status	Meaning
User indicator LEDs	GREEN, blinking	Light edges blink in GREEN when the device performs a good read. Note: In case of a good read, the Good/Bad read indicator LED is also blinking in GREEN.
	RED, blinking	Light edges blink in RED when the device performs a bad read when it does not find a decoding after a timeout. Note: In case of a bad read, the Good/Bad read indicator LED is also blinking in RED.
	WHITE	Light edges are WHITE when you trigger the Identify function in DataMan Setup Tool. For more information, see <i>DataMan Setup Tool Reference Manual</i> .
Power indicator LED	ON	The device is ON.
	OFF	The device is OFF.
Train/Trigger status indicator LED	ON	If the device has a trained code, this LED is GREEN.
	OFF	If the device has no trained code, this LED is OFF.
Good/Bad read indicator LED	GREEN, blinking	The device performs a good read. Note: In case of a good read, light edges are also blinking in GREEN.
	RED, blinking	The device performs a bad read when it does not find a decoding after a timeout. Note: In case of a bad read, light edges are also blinking in RED.
Communication	ON	This LED is on when the DataMan 280 series established the Ethernet connection.
	OFF	This LED is OFF when there is no Ethernet connection.
Error	ON	This LED is on if the DataMan 280 series reader detects an error.

Dimensions

The following sections list dimensions of the reader.

Note:



- Dimensions are in millimeters and are for reference purposes only.
- All specifications are for reference purposes only and can change without notice.

DataMan 280 with 6.2 mm lens

The following image shows the dimensions of DataMan 280, equipped with 6.2 mm lens.

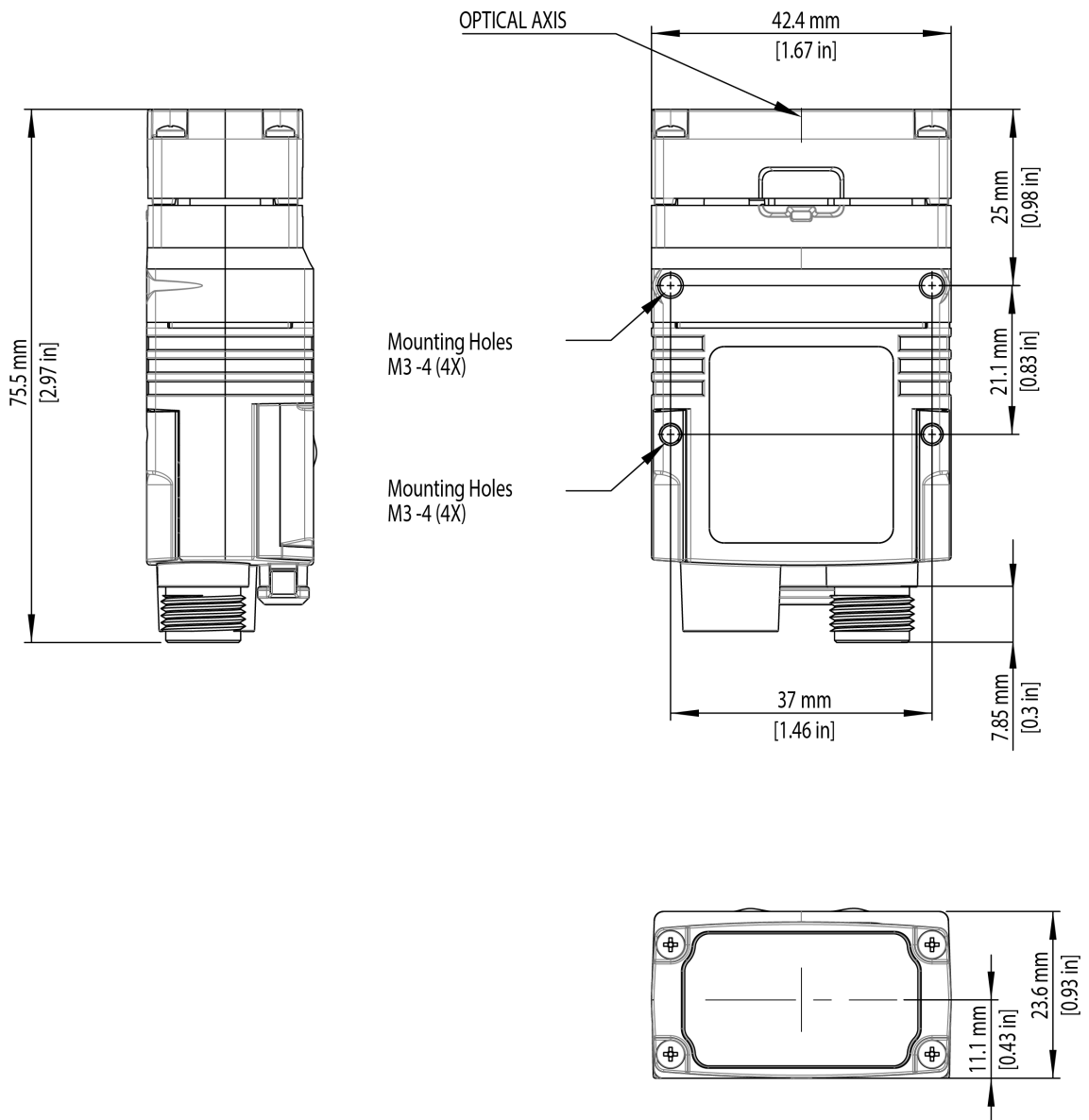

DataMan 280 with 16 mm Lens

The following image shows the dimensions of DataMan 280 equipped with 16 mm lens.

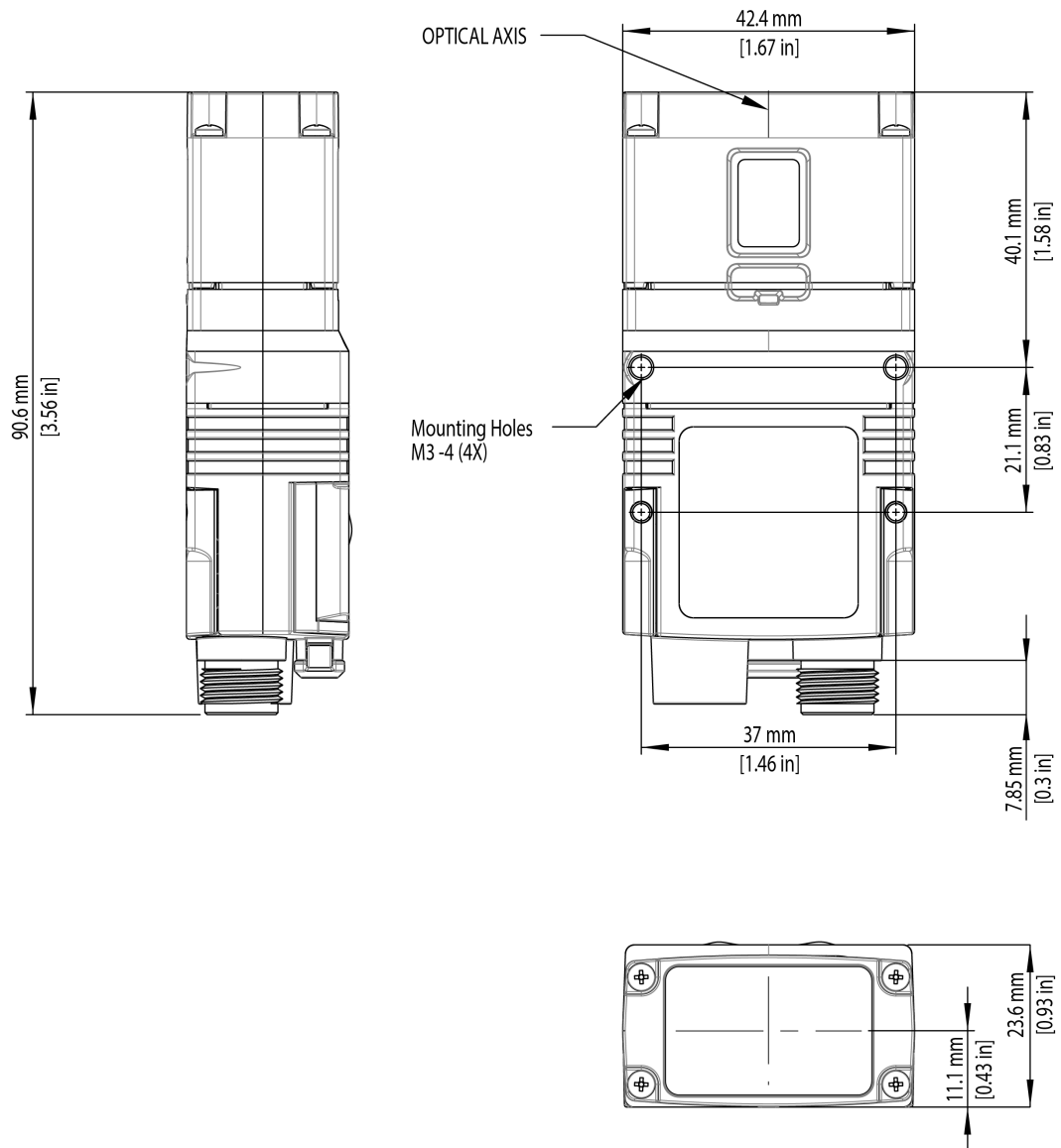

DataMan 280 with L-shaped extension, equipped with 6.2 mm Lens

The following image shows the dimensions of DataMan 280 equipped with L-shaped extension and 6.2 mm lens.

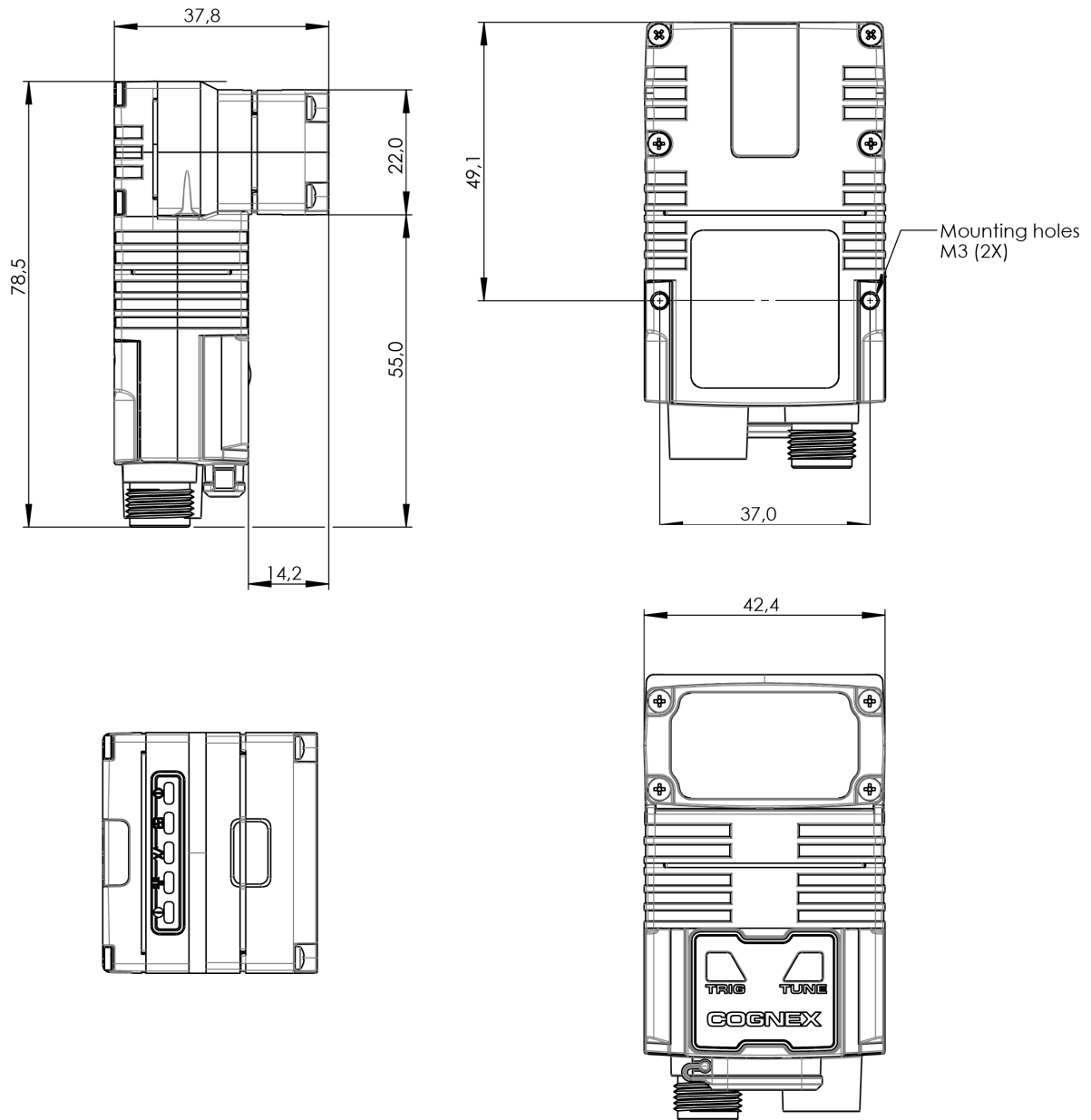

DataMan 280 with L-shaped extension, equipped with 16 mm Lens

The following image shows the dimensions of DataMan 280 equipped with L-shaped extension and 16 mm lens.

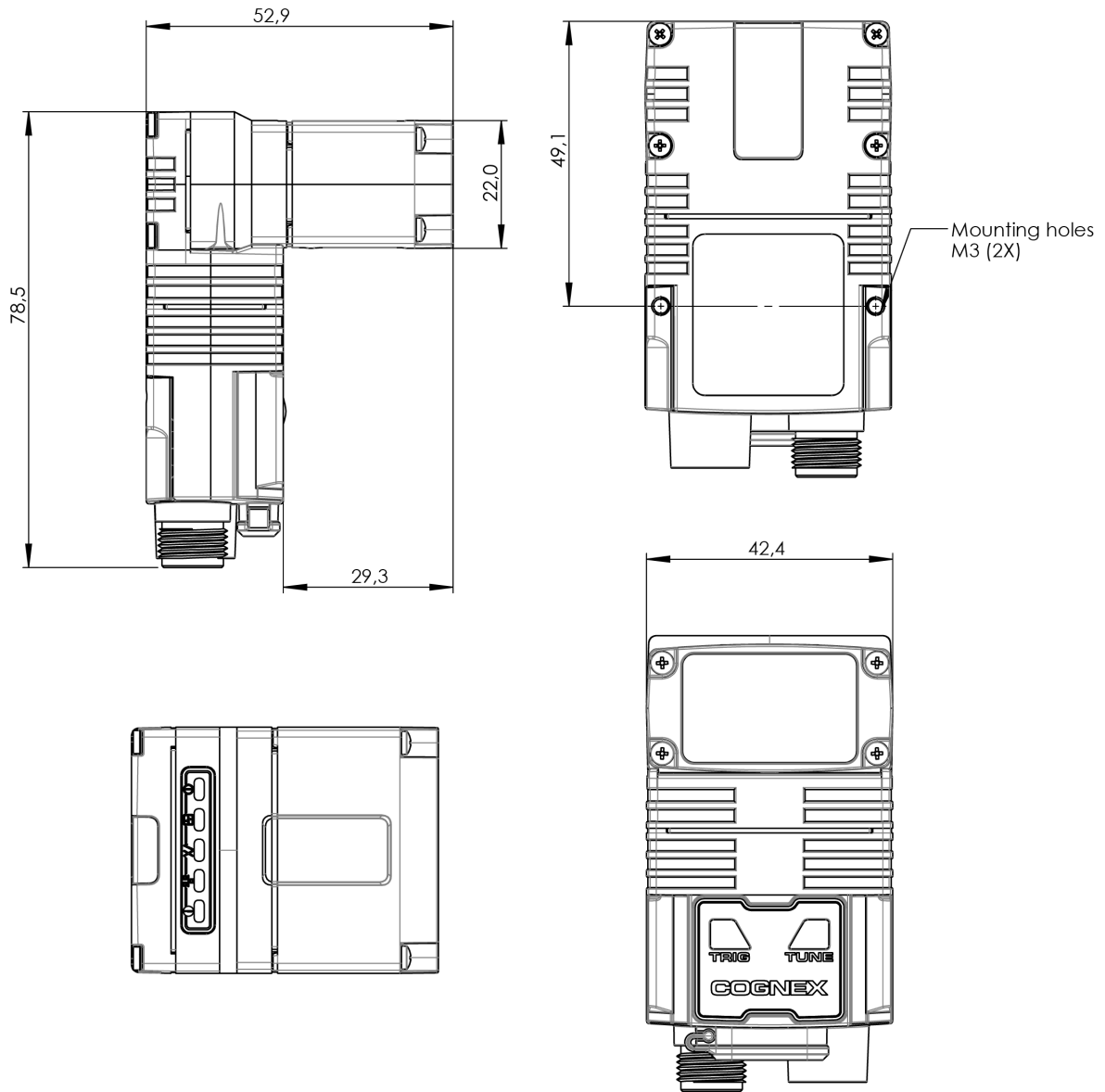

DataMan 282 with High Power Integrated Torch

The following image shows the dimensions of DataMan 282 equipped with high power integrated torch.

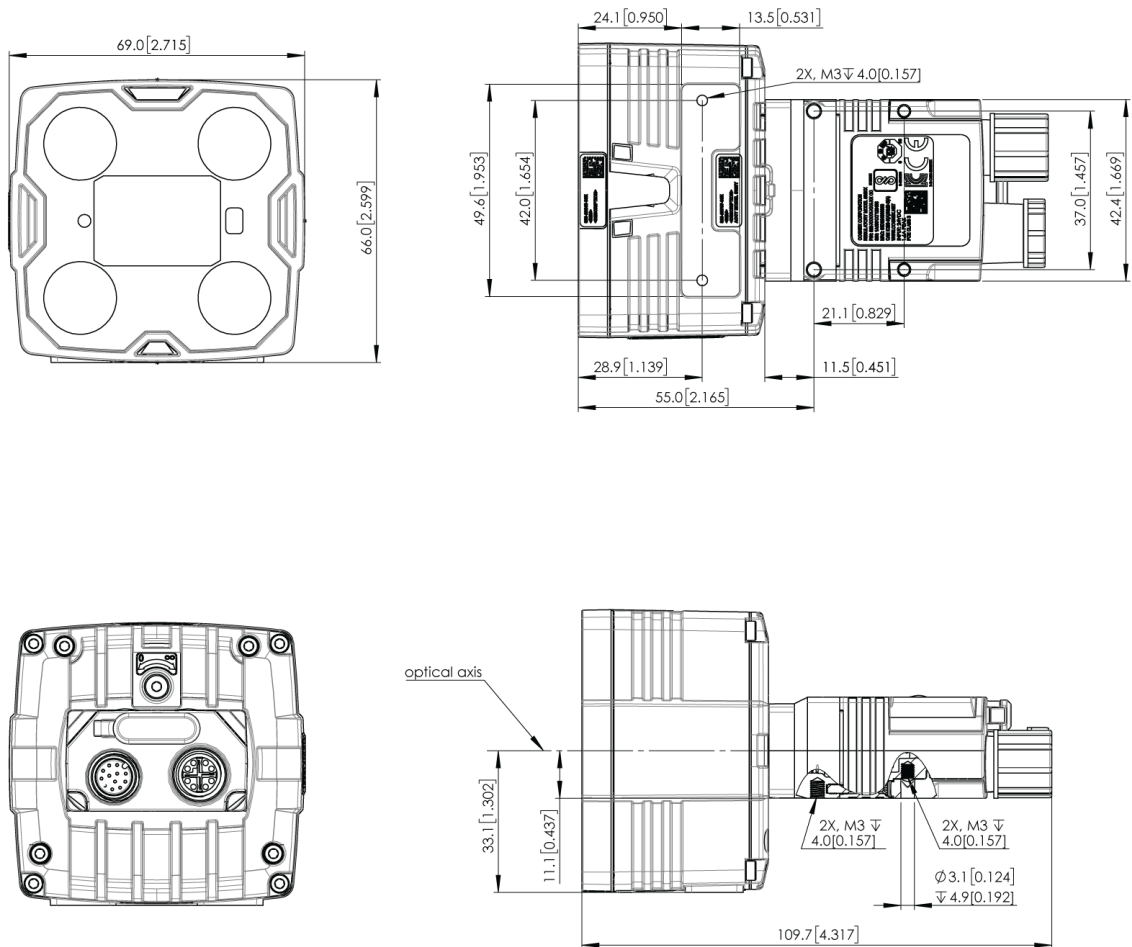

DataMan 282 with High Power Integrated Torch - L-Shaped Extension

The following image shows the dimensions of DataMan 282 equipped with high power integrated torch and L-shaped extension.

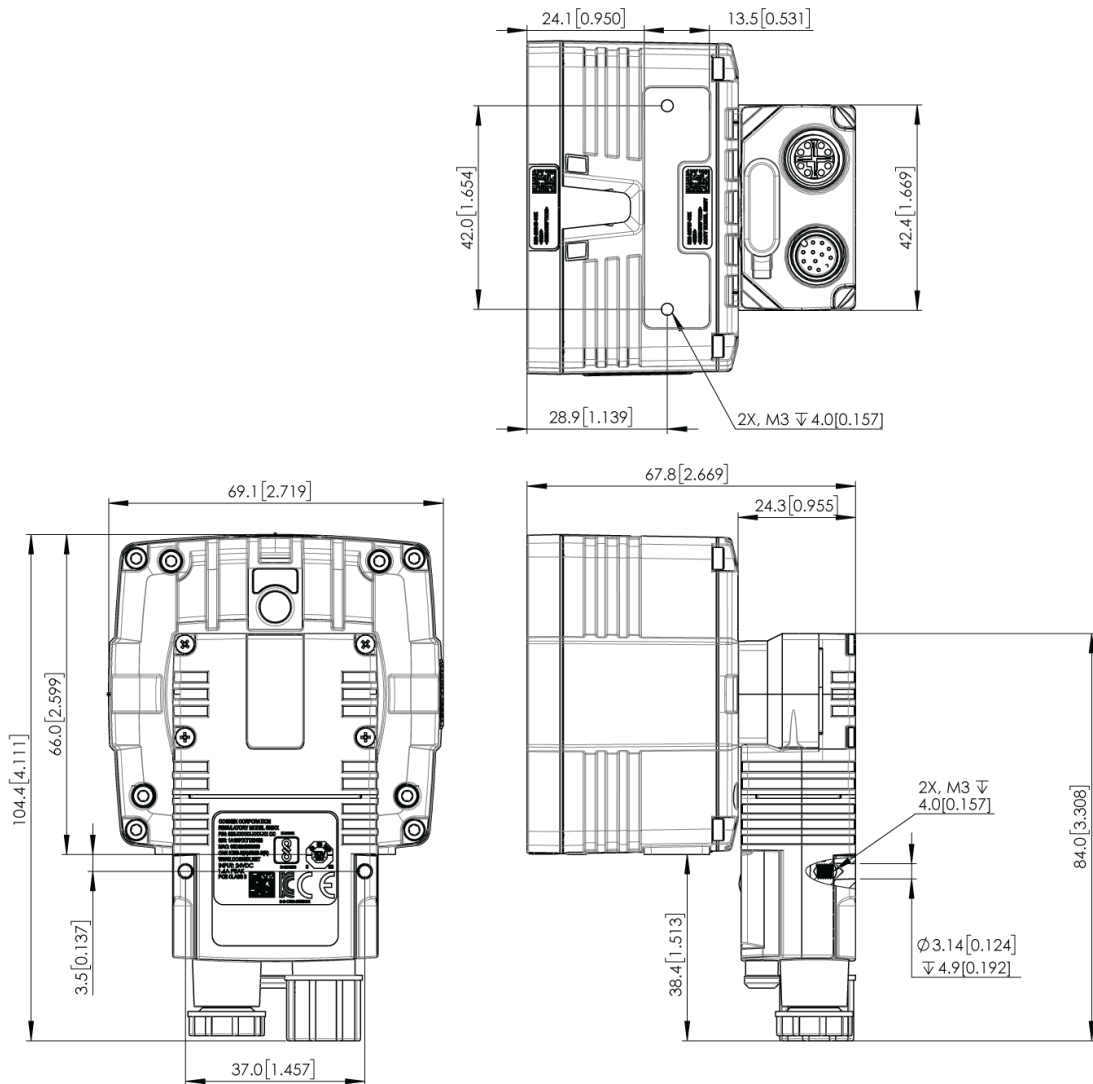

Dataman 282 with Dome Front Cover

The following image shows the dimensions of DataMan 282 equipped with a dome front cover.

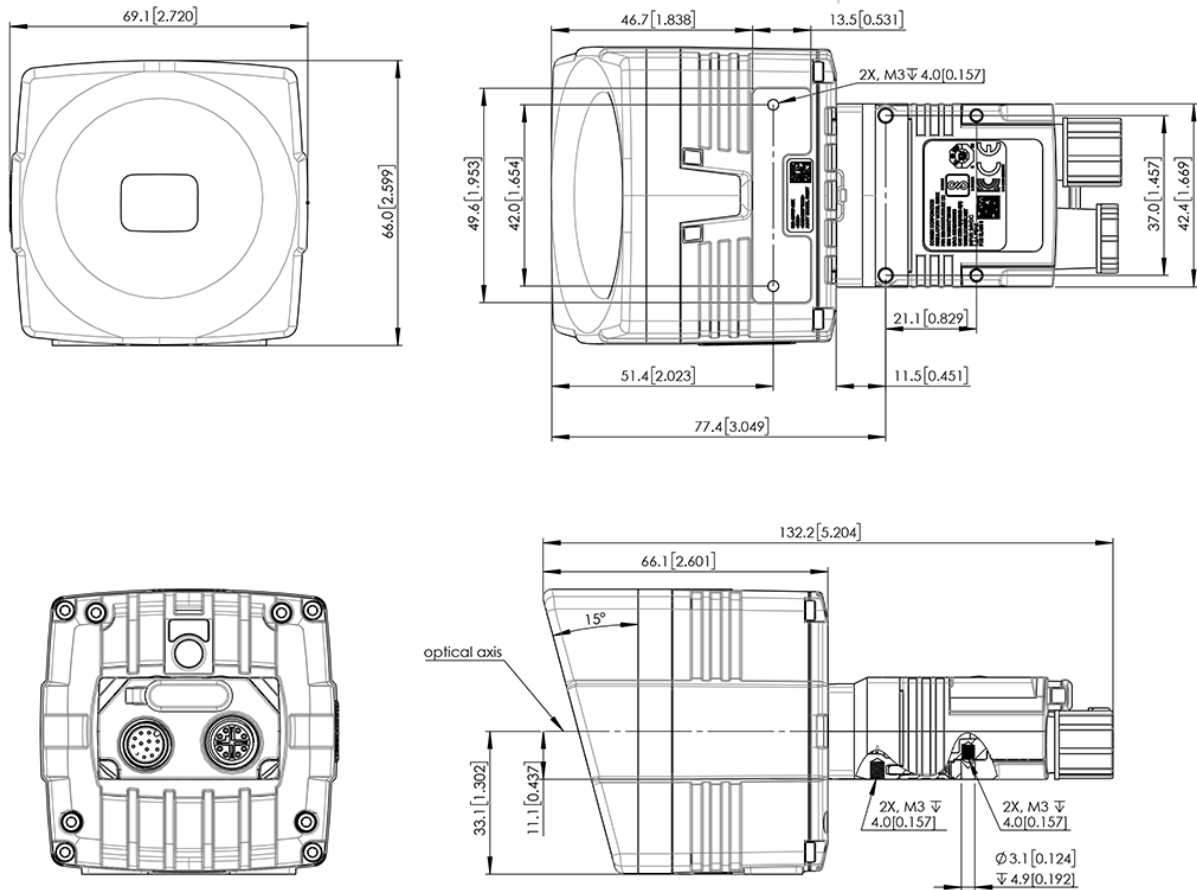

Dataman 282 with Dome Front Cover - Right Angle Configuration

The following image shows the dimensions of DataMan 282 equipped with L-shaped extension and dome front cover.

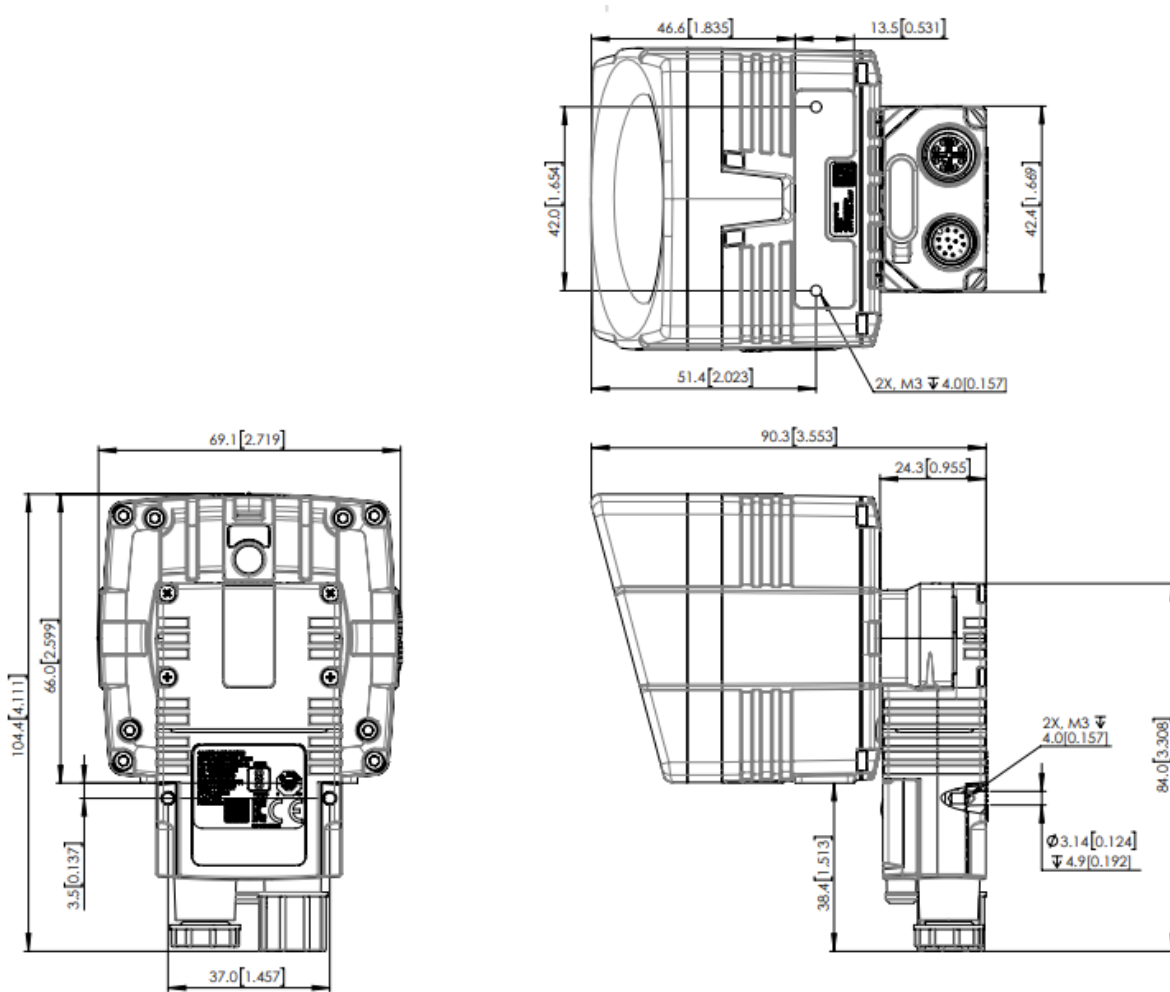

Field of View and Reading Distance

This section provides the Field of View (FoV) values for 6.2 mm and 16 mm lenses.

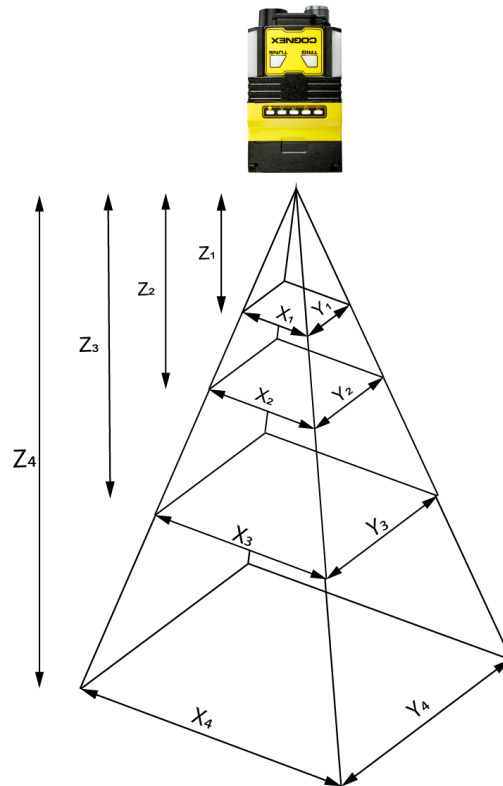

DataMan 280 Readers with 6.2 mm Lens

6.2 mm lenses can be focused to 105 mm (short range) and to 190 mm (long range).

Short Range (Focused to 105 mm)

The following tables show the Field of View (FoV) widths of the 6.2 mm lens focused to 105 mm at various distances.

Working distance in mm	Horizontal values in mm	Vertical values in mm
$Z_1 = 40$	$X_1 = 38$	$Y_1 = 29$
$Z_2 = 65$	$X_2 = 58$	$Y_2 = 44$
$Z_3 = 105$	$X_3 = 90$	$Y_3 = 68$

Distances in mm	2D min. code in mil	1D min. code in mil
40	4	2
65	5	3
105	10	5

Long Range (Focused to 190 mm)

The following table shows the Field of View (FoV) widths of the 6.2 mm lens focused to 190 mm at various distances.

Working distance in mm	Horizontal values in mm	Vertical values in mm
$Z_1 = 190$	$X_1 = 159$	$Y_1 = 119$
$Z_2 = 225$	$X_2 = 187$	$Y_2 = 140$
$Z_3 = 375$	$X_3 = 307$	$Y_3 = 230$
$Z_4 = 1000$	$X_4 = 808$	$Y_4 = 606$

Distances in mm	2D min. code in mil	1D min. code in mil
150	10	6
190	12	8
225	15	8
375	20	15
500	30	20
1000	60	35

DataMan 280 Readers with 16 mm lens

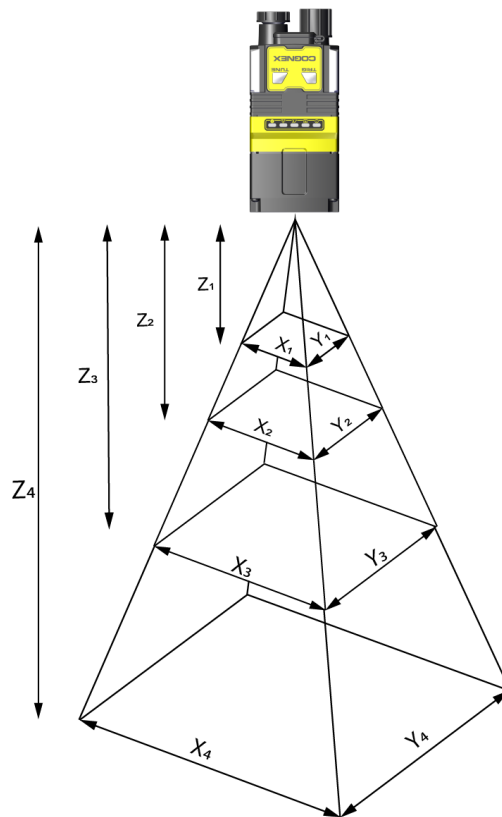

The following tables list the Field of View (FoV) widths of the 16 mm lens at various distances:

Working distance in mm	Horizontal values in mm	Vertical values in mm
$Z_1 = 150$	$X_1 = 46$	$Y_1 = 34$
$Z_2 = 225$	$X_2 = 69$	$Y_2 = 52$

Working distance in mm	Horizontal values in mm	Vertical values in mm
Z ₃ = 375	X ₃ = 116	Y ₃ = 87
Z ₄ = 1000	X ₄ = 310	Y ₄ = 232

Distances in mm	2D min. code in mil	1D min. code in mil
80	2	2
150	3	2
190	4	3
225	5	3
375	8	5
500	10	7
1000	20	15

DataMan 282 Readers with 8 mm Lens

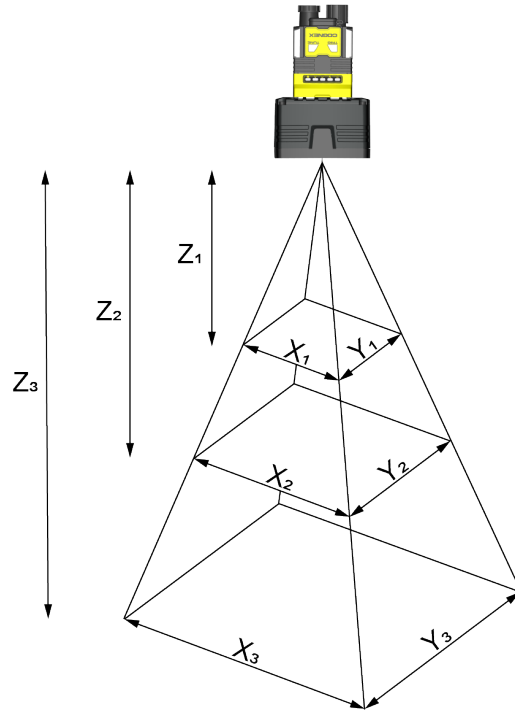

Working distance in mm	Horizontal values in mm	Vertical values in mm
$Z_1 = 300$	$X_1 = 223$	$Y_1 = 125$
$Z_2 = 750$	$X_2 = 526$	$Y_2 = 295$
$Z_3 = 1200$	$X_3 = 828$	$Y_3 = 466$

Working Distance in mm	2D min. code in mil	1D min. code in mil
300	12	7
750	18	12
1200	22	15

DataMan 282 Readers with 12 mm Lens

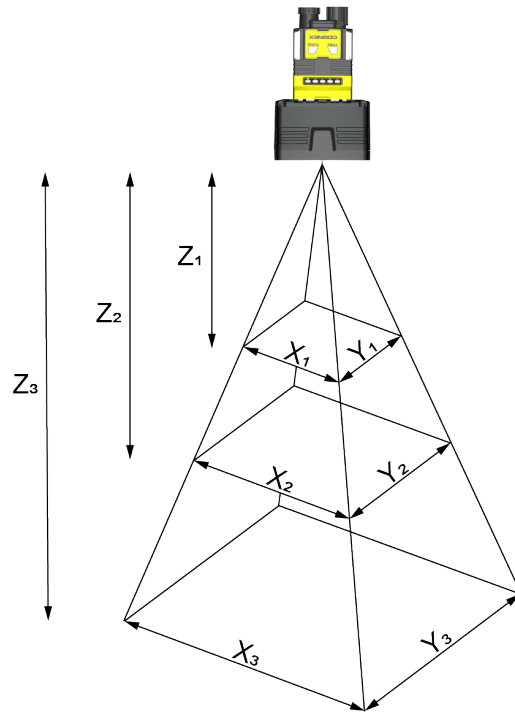

Working distance in mm	Horizontal values in mm	Vertical values in mm
$Z_1 = 300$	$X_1 = 141$	$Y_1 = 79$
$Z_2 = 750$	$X_2 = 343$	$Y_2 = 193$
$Z_3 = 1200$	$X_3 = 545$	$Y_3 = 306$

Working Distance in mm	2D min. code in mil	1D min. code in mil
300	10	6
750	18	11
1200	22	15

DataMan 282 Readers with 16 mm Lens

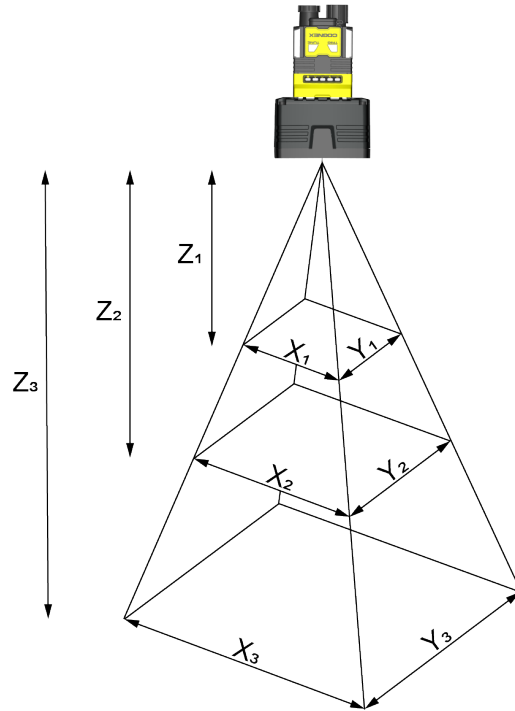

Working distance in mm	Horizontal values in mm	Vertical values in mm
$Z_1 = 300$	$X_1 = 105$	$Y_1 = 59$
$Z_2 = 750$	$X_2 = 256$	$Y_2 = 144$
$Z_3 = 1200$	$X_3 = 407$	$Y_3 = 229$

Working Distance in mm	2D min. code in mil	1D min. code in mil
300	8	5
750	16	9
1200	22	14

Connecting the Reader



1	Installing a C-Mount Lens on page 36
2	Mounting the Reader on page 48
3	Connecting the Ethernet Cable to DataMan 280 Series Readers on page 53
4	Connecting the Power and I/O Breakout Cable on page 53

Installing and Changing Lenses

This section provides an overview about installing and changing different kinds of lenses.

- [Installing a C-Mount Lens on page 36](#)
- [Changing a 6.2 mm Lens to a 16 mm Lens on page 40](#)
- [Installing a High Speed Liquid Lens on page 44](#)

Note: Use a Phillips screwdriver with drive size #1 for all Phillips screws that are reachable from the front side.

Note: Disconnect the reader from power before changing lenses or mounts.

CAUTION: Perform all lens modification procedures in a dust-free and ESD safe area.

Installing a C-Mount Lens

1. Unscrew the four M2x12mm Phillips Pan head screws, then take off the metal cover from the reader.

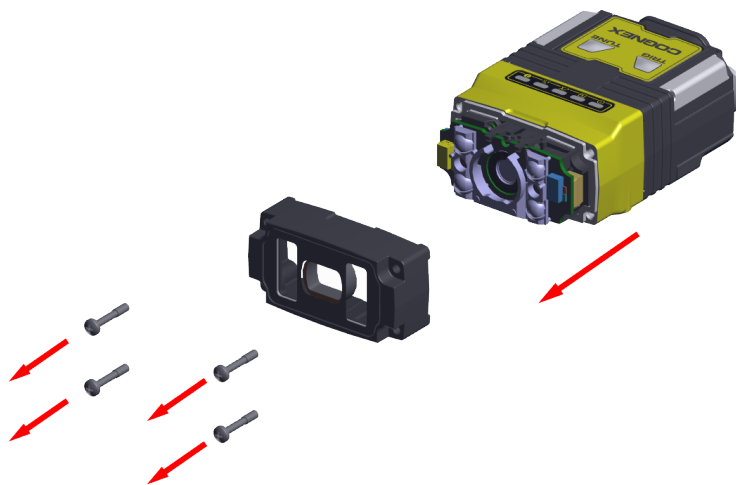

2. Remove the illumination module.



3. Unscrew the two M2x5mm Phillips head screws, remove the 6.2 mm lens mount and the 6.2 mm lens.



4. Place the C-Mount cover on the front of the device, and tighten the screws.

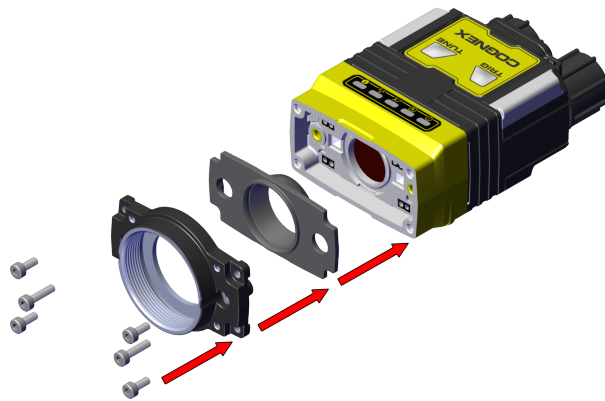

Note:

Observing the tightening sequence below, tighten all six M2 x 12 mm Phillips Pan screws to 12 Ncm using a torque wrench.

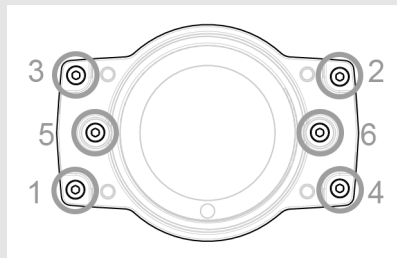

5. Place the lens cover adapter plate on the C-Mount cover, and tighten the screws.

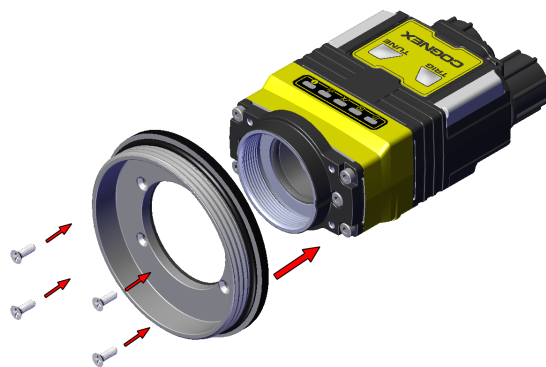

6. Thread the lens into the reader.



7. Screw the lens cover onto the lens cover adapter.

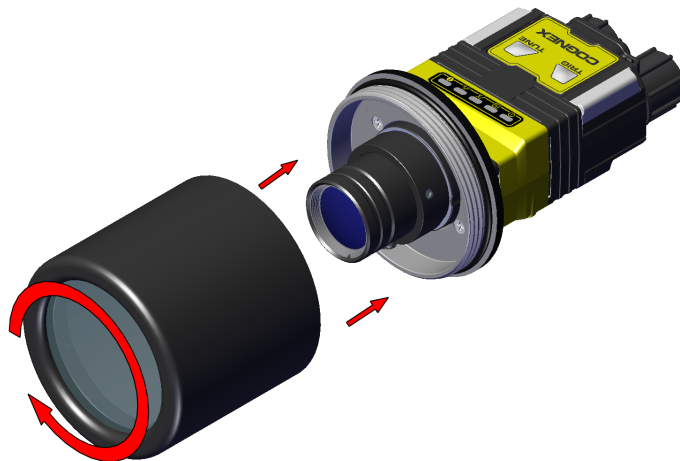

Changing a 6.2 mm Lens to a 16 mm Lens

This section provides a step-by-step process for changing the 6.2 mm lens to a 16 mm lens on the reader.

1. Unscrew the four M2x12mm Phillips Pan head screws, then take off the metal cover from the reader.

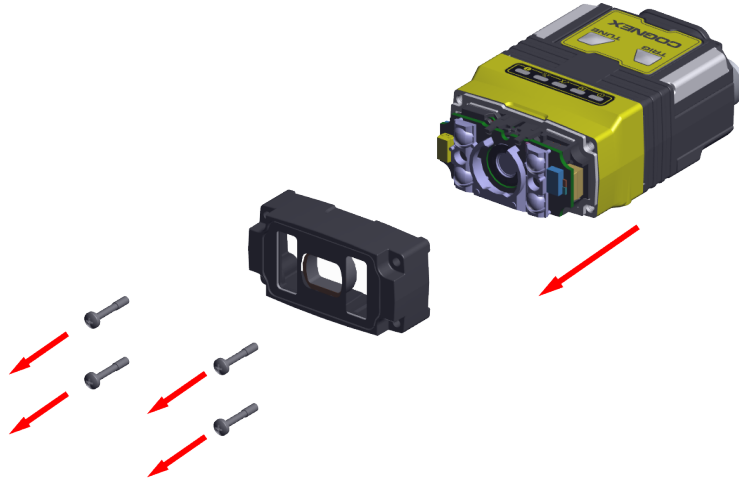

2. Remove the illumination module.



-
3. Unscrew the two M2x5mm Phillips head screws, remove the 6.2 mm lens mount and the 6.2 mm lens.



4. Attach the 16 mm lens mount and lens, and screw in the two M2x5mm Phillips head screws. Focus, if necessary. For more information, see [Setting Focus on page 49](#).

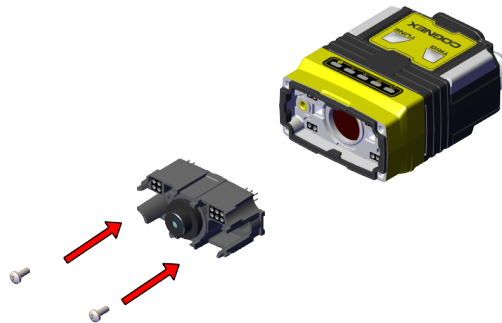

5. Attach the 16 mm lens illumination module.

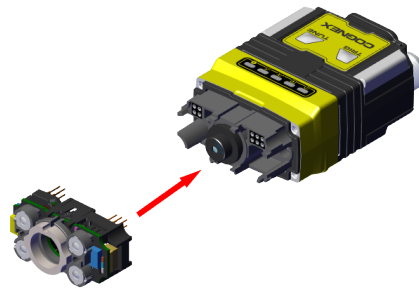

6. Attach the 16 mm lens front cover.

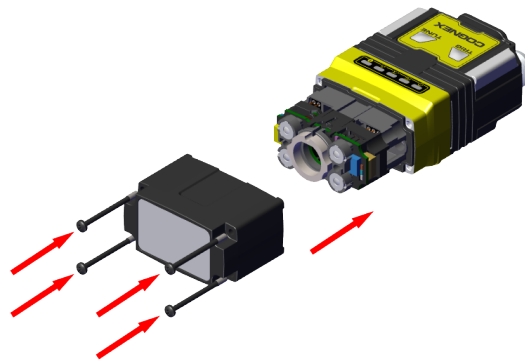

i Note: The rib in the front cover must be oriented to the top side.

Note:
Observing the tightening sequence below, tighten all four M2 x 12 mm Phillips Pan screws to 16 Ncm using a torque wrench.

i

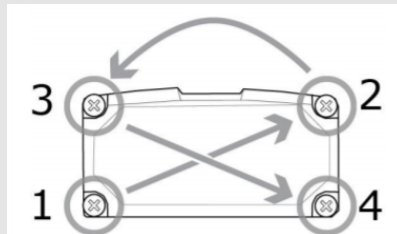

Installing a High Speed Liquid Lens

This section shows the process of installing a liquid lens onto the DataMan 280 with a 6.2 mm lens.

1. Unscrew the four M2 x 12 mm Phillips Pan head screws, then take off the metal cover from the reader.

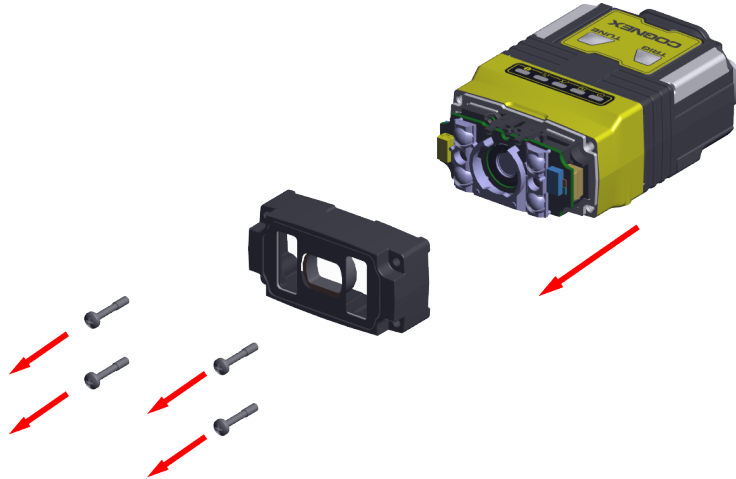

2. Remove the illumination module.



3. Turn the lens cap to the 105 mm position.



4. Carefully remove the lens cap from the imager lens.



Note: In order not to lose focus calibration, do not rotate the imager lens while the lens cap is removed.

5. Attach the liquid lens accessory by aligning the 2x2 connectors of the liquid lens with the 2x2 sockets on the optics mount.



6. Press the liquid lens onto the imager lens until you reach the stop.



7. Re-attach the illumination module.



8. Re-attach the front cover.

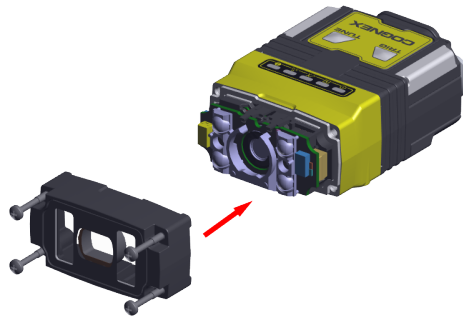

Note: The rib in the front cover must be oriented to the top side.

Note:
Observing the tightening sequence below, tighten all four M2 x 12 mm Phillips Pan screws to 16 Ncm using a torque wrench.

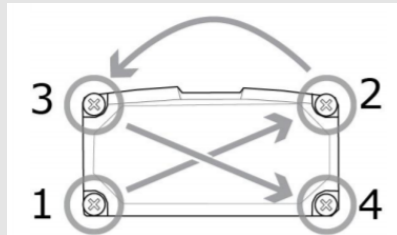

Installing Front Cover on High-Power Integrated Torch

1. Screw in the four screws from the light module housing into the front cover.

The following image depicts the dome front cover. The same instructions apply to polarized and diffuse front covers.

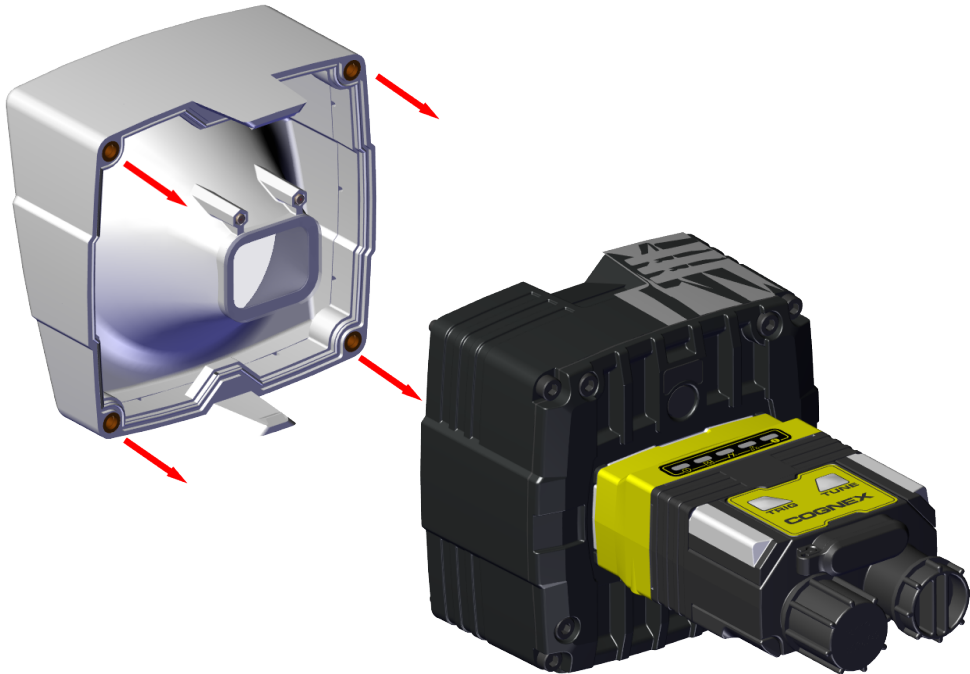

Note:

Observing the tightening sequence below, tighten all four M2.5 x 34 mm Phillips Pan screws to 0.25 Ncm using a torque wrench.

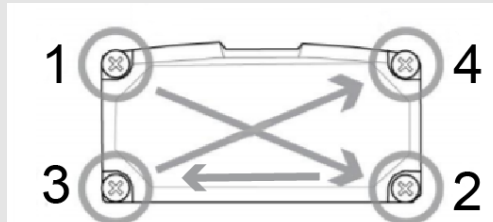

Mounting the Reader

The reader provides mounting holes for attachment to a mounting surface.

CAUTION: The reader has to be grounded, either by mounting the reader to a fixture that is electrically grounded or by attaching a wire from the reader's mounting fixture to frame ground or Earth ground. If a ground wire is used, it has to be attached to one of the four mounting points on the bottom plate of the reader and not to the mounting points on the front of the reader.

The method of mounting depends on whether the reader is in straight or right-angle configuration, regardless of the product variant.

Mounting the Reader in Straight Configuration

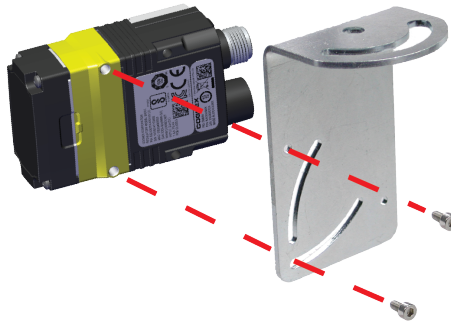

Align the holes on the mounting surface with the mounting holes on the reader. Insert the M3 screws into the mounting holes.

Mounting the Reader in Right-Angle Configuration

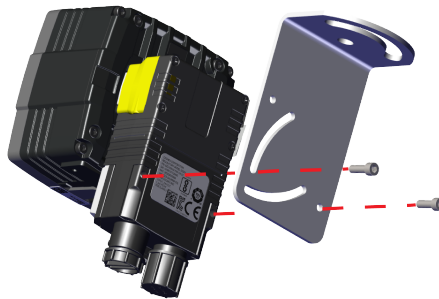

Align the holes on the mounting surface with the mounting holes on the reader. With the reader in right-angle position, only the back mounting holes can be used.

Note:

Mounting the reader at a slight angle (15°) reduces reflections and improves performance.

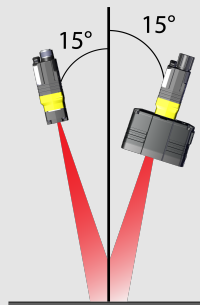

Setting Focus

There is a range of reading distances available for different code sizes and focus positions. To set focus on your reader, use the following options depending on whether you use a liquid lens or a manual focus lens.

DataMan readers are compatible with multiple different lenses. Each lens has a range of reading distances available for different code sizes and focus positions. Having accurate focus settings is essential to maximize read rates.

To set the focus on your reader, use the following options depending on whether you use a liquid lens or a manual focus lens.

Note:

The DataMan Setup Tool has focus sheets that can help you manually adjust lenses or swapping between them.

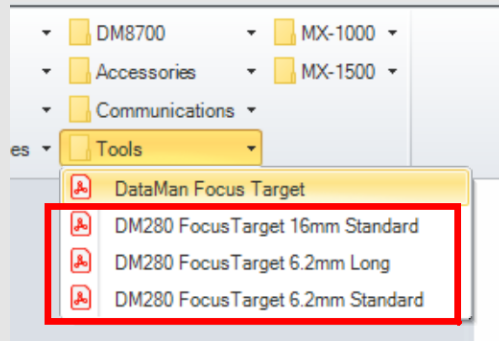

Manual Focus Lens

Click the **Focus Feedback** button in the image panel in SetupTool to enable focus feedback.

This enables a color-coded focus feedback bar on the right side of the image panel. Once focus feedback is enabled, enter live mode and manually adjust the lens until the focus feedback bar is green.

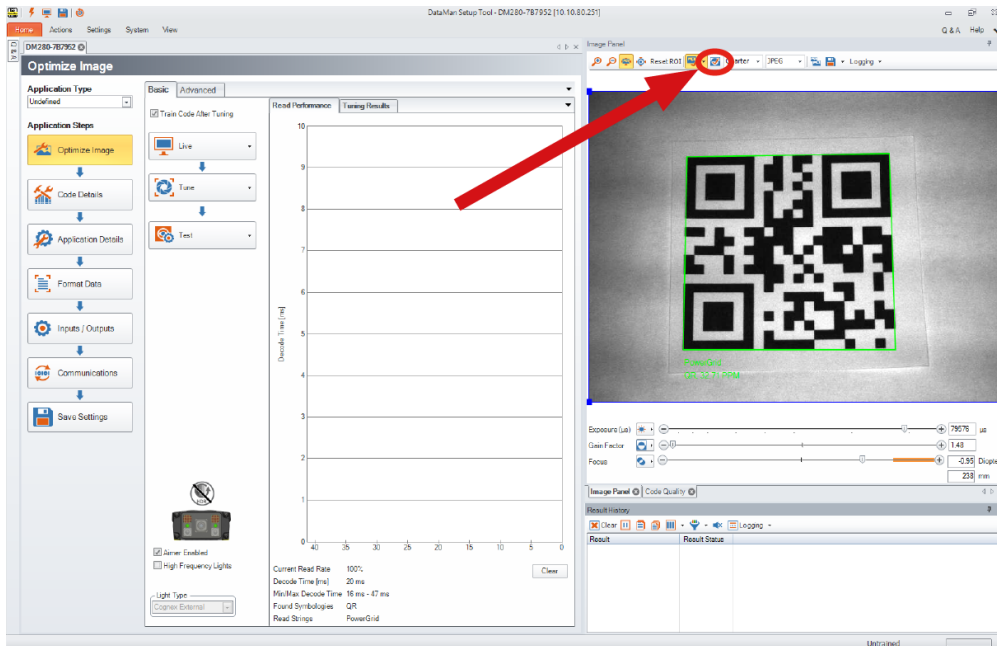

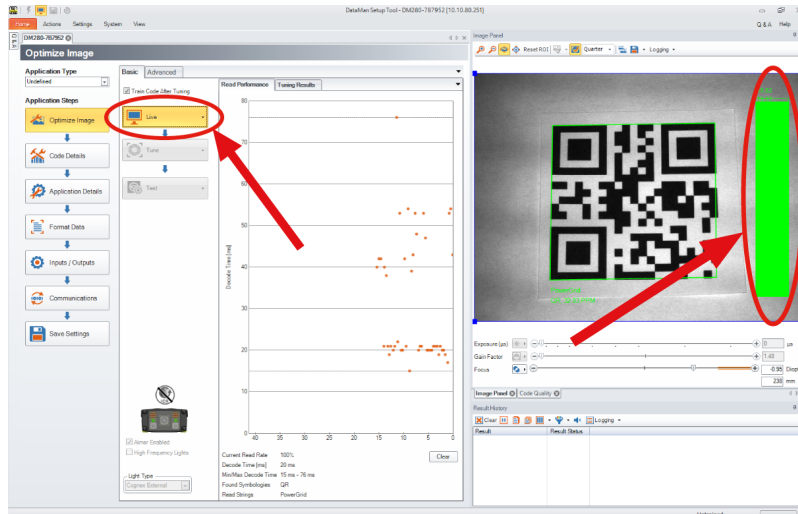

Focus Feedback

Focus is indicated by colors ranging from red (bad focus) to green (sharp focus). When focusing the reader, you need to adjust its position until the focus column becomes green.

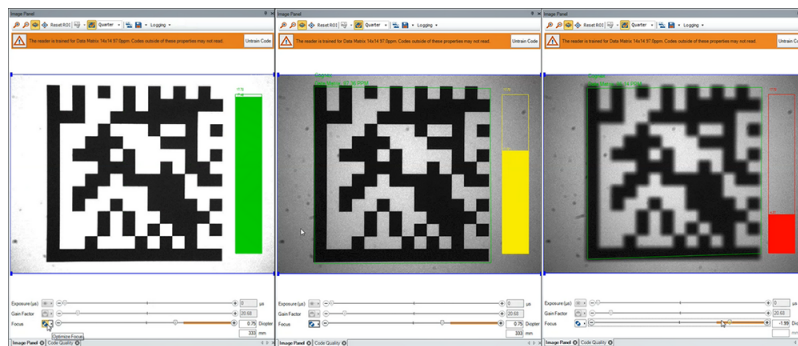

Best Practices

Both **Optimize Focus** and the **Focus Feedback** use the same procedure for testing the current focus. They consider various sub-regions of the image.

Follow these guidelines to maximize the performance of **Optimize Focus** and **Focus Feedback**:

- Use a focus target (such as the one supplied with this Reference Manual) that includes high-contrast features and is big enough that it fills at least a 100 x 100 pixel region in the center of the field of view at the desired working distance.
- Avoid floppy pieces of paper and make sure the target is perfectly flat.
- Make sure that the target is perfectly perpendicular to the optical axis of the reader.
- Make sure that the rest of the field of view, such as the part not covered by the focus target, does not contain any high-contrast features. For example, you would ideally fill the entire field of view with a white card or sheet of paper (to avoid shadows), and position the focus target in the middle.
- The supplied 120 x 120 mm focus target is appropriate for typical working distances. If you use such a working distance that the target does not completely fill the image, make sure that there are no high-contrast features visible outside of the target (see previous bullet).

Note:



- If you use the focus feedback indicator to adjust a manual focus lens, you must apply power to the reader before you remove the cover. If you remove the cover before applying power, the internal illumination will not function.
- If you use a Liquid Lens, make sure that the cover is mounted and connected before you apply power. If you attach or remove the front cover while the reader is powered, the focus setting is lost.

Connection Options

This section summarizes connection options.

For more information on how to connect your DataMan reader to your network, see the *DataMan Communications and Programming Guide*.

Connecting the Ethernet Cable to DataMan 280 Series Readers

CAUTION: The Ethernet cable shield has to be grounded at the far end. Whatever this cable is plugged into (typically a switch or router) should have a grounded Ethernet connector. A digital voltmeter has to be used to validate the grounding. If the far end device is not grounded, a ground wire should be added in compliance with local electrical codes.



1. Connect the Ethernet cable's M12 connector to the reader ENET connector.
2. Connect the Ethernet cable's RJ-45 connector to a switch/router or PC, as applicable.

Note:

- Besides powering the DataMan 280 readers through a Breakout Cable, it is possible to power DataMan through PoE connection as well, in which case it is not necessary to use a Breakout Cable.
- DataMan 282 readers do not support PoE.



DataMan 282 Readers LED Behavior with PoE

DataMan 282 Readers require 24 V DC to operate. If you try to power the reader with a PoE cable, the reader boots up, but the illumination shuts down. The error LED of the reader turns solid red to indicate an underpowered state. You can overwrite the behavior of the error LED in the **Inputs / Outputs** application step of the DataMan Setup Tool. For more information on how to configure the error LED, refer to the *DataMan Questions and Answers* document.

Connecting the Power and I/O Breakout Cable

CAUTION: To reduce emissions, connect the far end of the Breakout cable shield to frame ground.



Note:



- Perform wiring or adjustments to I/O devices when the reader is not receiving power.
- You can clip unused wires short or use a tie made of non-conductive material to tie them back. Keep bare wires separated from the +24 V DC wire.

1. Verify that the 24 V DC power supply is unplugged and not receiving power.
2. Attach the +24 V DC connector of the Power and I/O Breakout cable and Ground wires to the corresponding terminals on the power supply. For more information, see [Specifications on page 65](#).



CAUTION: Never connect voltages other than 24 V DC. Always observe the polarity shown.

3. Attach the M12 connector of the Power and I/O Breakout Cable to the 24 V DC connector of the reader.
4. Restore power to the 24 V DC power supply and turn it on if necessary.

Using your Device through USB

You can use the USB connector of the DataMan 280 in the following ways:

- Emulating serial (USB-COM) functionality

The DataMan 280 establishes the connection through emulated serial port.

- Emulating Ethernet functionality

The DataMan 280 establishes the connection through emulated Ethernet.

- As HID (Human Interface Device)

If you use DataMan 280 in HID mode, the device serves as an emulated keyboard.

Emulating Serial Functionality

If you connect a USB-C cable, you can see a COM port in the Windows Device Manager, as a generic USB-COM port.

To emulate serial functionality:

1. Set the **USB Connection** properties in the **Serial** tab of the **Communication Settings** panel in DataMan Setup Tool.
2. Look at the Windows Device Manager to identify the proper device.
3. Enable the **Serial-over-USB** option in DataMan Setup Tool, because it is disabled by default.

Emulating Ethernet Functionality

You have to configure the connection between the PC and the DataMan 280 in order to use the emulated Ethernet-over-USB functionality.

The DataMan 280 has the fixed IP 192.168.111.2/24 through an emulated Ethernet connection.

To configure the PC-emulated Ethernet driver to be in the same LAN, do the following:

1. Connect the PC to the DataMan 280 with an USB-C cable.
2. Make sure to have the WebHMI enabled in DataMan Setup Tool (by default, this option is disabled).
3. Open Control Panel and select Network and internet.
4. Select Network and Sharing Center, then select Change adapter settings.
5. Identify the virtual adapter. On the example image below, it's Ethernet 5.

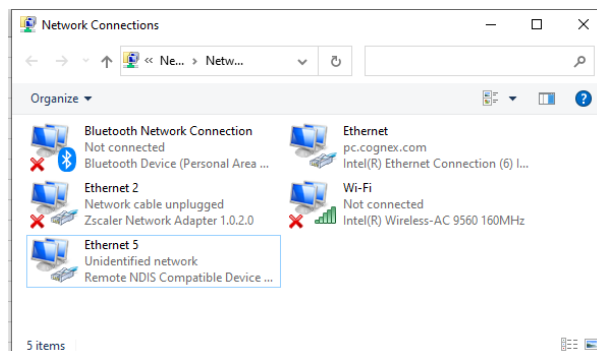

6. Right-click on the virtual adapter and select Properties. Assign a fixed IP to the network adapter starting with 192.168.111.

Use Case Examples

To connect to the DataMan Setup Tool:

1. Connect the PC to the DataMan 280 with an USB-C cable
2. Set up the Ethernet emulation as described in [Emulating Ethernet Functionality on page 54](#).
3. Open the DataMan Setup Tool.

4. Navigate to the **Home > Repair and Support** page, click **Add Network Device**, and enter the 192.168.111.2 IP address. Click **OK**.

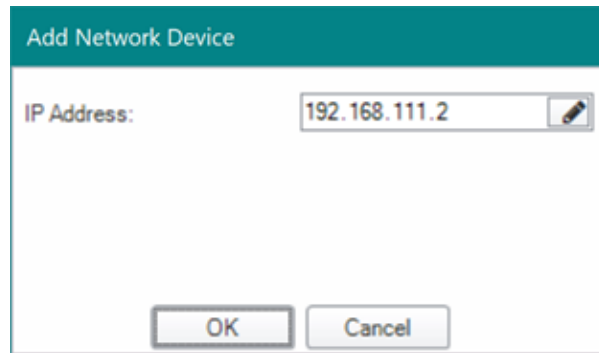

5. Connect to the reader.

To connect through Telnet:

1. Connect the PC to the DataMan 280 with an USB-C cable.
2. Set up the Ethernet emulation as described in [Emulating Ethernet Functionality on page 54](#).
3. Open a Telnet connection with the 192.168.111.2/23 IP address.

To connect to the WebHMI:

1. Connect the PC to the DataMan 280 with an USB-C cable.
2. Set up the Ethernet emulation as described in [Emulating Ethernet Functionality on page 54](#).
3. Enable the WebHMI in DataMan Setup Tool. By default, this option is disabled.

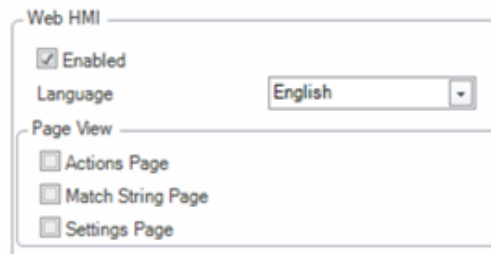

Note: Note: The WebHMI takes a few seconds to launch.

4. Open a browser and enter 192.168.111.2 into the address bar to connect to the WebHMI through the virtual IP address.

WebHMI is a use case example. You can also use Telnet or DataMan Setup Tool for emulating Ethernet functionality.

- Telnet: Open Telnet connection with 192.168.111.2/23 IP address.
- DataMan Setup Tool:
 - a. Click **Add Network Device** on the Home, Repair and Support page and enter the 192.168.111.2 IP address. Click **OK**.
 - b. Connect to the reader.

USB-Keyboard (HID) Functionality

To use the DataMan 280 as an emulated keyboard, set the language of the keyboard in the DataMan Setup Tool. HID reports use the keyboard language set in the drop down menu.

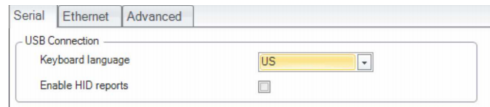

To enable HID reports, tick the checkbox in DataMan Setup Tool.

Note:



- Communication through HID reports is similar to using a physical keyboard.
- Using keyboard emulation with applications supporting hotkeys can result in unexpected behavior, depending on the data of the read codes.

Using Your DataMan Reader

This section provides information on the installation of the DataMan Setup Tool, trigger types, and protocols.

Installing the DataMan Setup Tool

Follow the steps below to install and connect your reader to the DataMan Setup Tool.

1. Check the DataMan **Release Notes** for a full list of system requirements.
2. Download the latest version of the DataMan Setup Tool from support.cognex.com/downloads/dataman/software-firmware and follow the on-screen steps.
3. Connect the 280 series reader to your PC.
4. Launch the DataMan Setup Tool and click **Refresh**. Detected devices appear under **COM ports** or **Network devices**, or both.
5. Select a reader from the list and click **Connect**.

Trigger Types

The DataMan 280 readers support the following trigger modes:

- **Self**: At a time interval you configure, the reader acquires an image and runs the job continuously.
- **Single** (external trigger): Acquires a single image and attempts to decode any symbol it contains, or more than one symbol in cases where multicode is enabled. The reader relies on an external trigger source.
- **Presentation**: Scans, decodes and reports a single code in the field of view. The reader relies on an internal timing mechanism to acquire images.
- **Manual**: Begins acquiring images when you press the trigger button on the reader, and continues acquiring images until a symbol is found and decoded or you release the button.
- **Burst** (external trigger): Performs multiple image acquisitions based on an external trigger and decodes any symbol appearing in a single image or within a sequence of images, or multiple symbols in a single image or within a sequence of images when multicode is enabled. You can control the number of images within each burst and the interval between image acquisitions.
- **Continuous** (external trigger): Begins acquiring images based on a single external trigger and continues to acquire and decode images until a symbol is found and decoded, or until multiple images containing as many codes as specified in multicode mode are located, or until the trigger is released. You can configure your reader to acquire images based on the start and stop signal from separate digital IO pulses.

External Triggers

If you are using external triggering, you can use any of the following methods to trigger your reader.

- Press the trigger button on the reader.



- Send a pulse on the I/O cable.
 - Trigger +
 - Trigger -
- Send a trigger command over any serial connection .
- Press **CTRL+T** on the keyboard while the DataMan Setup Tool has the input focus.
- Click the **Trigger** button in the DataMan Setup Tool.

Note: You can also initiate external triggering through industrial protocols from a programmable logic controller.

Training the Reader

Training your reader with the expected symbology can make the time required to decode successive symbols more consistent. In addition, training may help increase decode yield.

To train your reader, place a code in front of the reader and do one of the following:

- Press and hold the trigger button for a minimum of three seconds.



- Click **Train Code** under **Actions** on the ribbon bar.

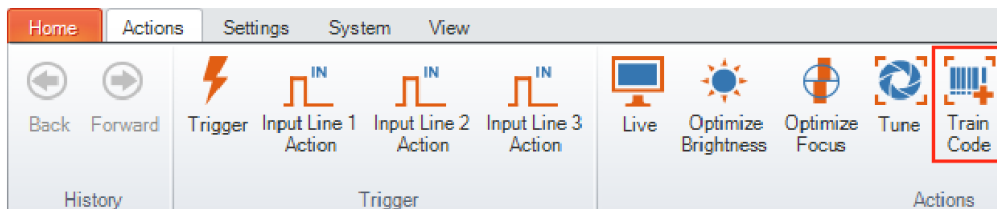

You can use training in **Single**, **Burst**, **Continuous** or **Self** trigger modes.

Note: Only a single symbol of each symbology kind can be trained.

Manual Training

You can manually train your reader which is helpful if you do not have a barcode nearby or you need to train during a running production.

1. Click **Advanced** under the **Code Details**.
2. In the **Training** tab, you can manually train a code by entering the attributes.
3. Check the **Is Valid** checkbox.

Training	
Disable Untrained Symbologies	<input checked="" type="checkbox"/>
Incremental Training	<input type="checkbox"/>
Data Matrix	
Training	Trained Untrain Code
Manual Code Training	
Number of Rows	18
Number of Columns	18
Module Size (pixels)	22.8
Polarity	Dark On Light
Mirrored	<input type="checkbox"/>
Is Valid	<input checked="" type="checkbox"/>

Training Feedback

The second LED from left on the reader glows green to indicate that it is currently trained. If the reader has no trained code, the LED is off.



Connect the reader to the DataMan Setup Tool to untrain it and allow it to recognize other enabled symbologies.

Incremental Training for Multiple Symbologies

If you want to train the reader to recognize multiple symbologies, you can present a single image showing all the desired symbologies and perform the training procedure previously described.

If you cannot present a single image showing all the necessary symbologies, you can enable incremental training under **Training** on the **Advanced** tab of the **Code Details** pane:

Code Details

Application Type: Undefined

Application Steps:

- Optimize Image
- Code Details
- Application Details
- Format Data
- Inputs / Outputs

Basic | **Advanced**

Non-Default Values

General

- 2D
- 1D

Multicode

Number of Codes	1
Allow Partial Results	<input type="checkbox"/>

Data Matrix

QR Code / MaxiCode / Aztec Code

DotCode

1D / Stacked / Postal

Sorting Priority	Symbology.
------------------	------------

Training

Disable Untrained Symbologies	<input checked="" type="checkbox"/>
Incremental Training	<input type="checkbox"/>

With incremental training enabled, you can train the reader using multiple images showing the symbologies you expect to decode. The reader will train each new symbology while retaining the existing trained symbologies.

DM282 LED Configurations

In the DataMan Setup Tool, you can control the primary illumination color of the LED lights of the reader in the **Optimize Image** tab. The default color is red.

The following colors are available:

- Red
- Green
- Blue
- White

To change the color of the LEDs, click on one of the color icons:

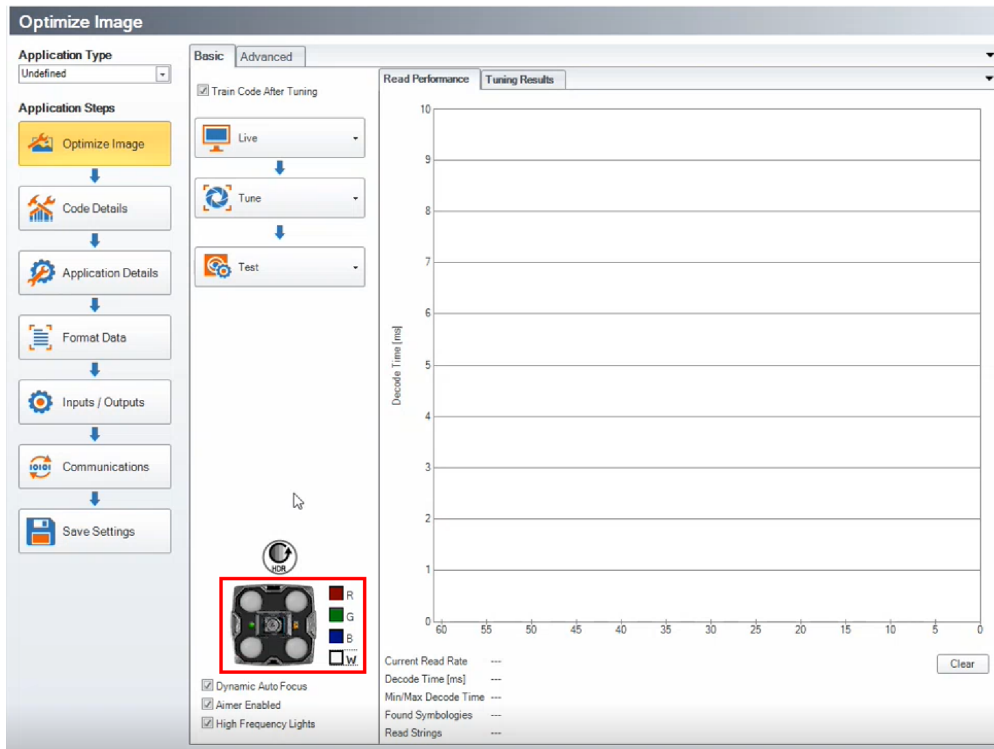

In the **Inputs / Outputs** pane, you can assign a LED color for the input/output events. For example, you can set a color for a successful read and set a different color for an unsuccessful read.

1. Check the **Custom Indicator LED** checkbox.

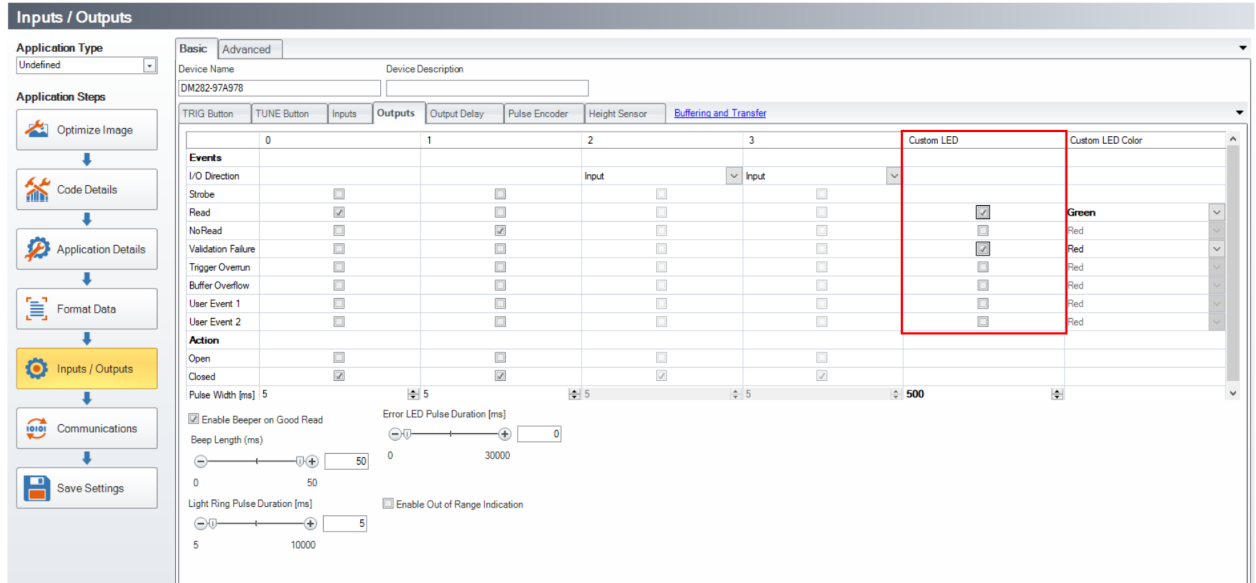

2. Pick a custom LED color in the **Custom LED Color Selector** column.

The screenshot shows the 'Inputs / Outputs' configuration page. On the left, there is a sidebar with 'Application Steps' including 'Optimize Image', 'Code Details', 'Application Details', 'Format Data', 'Inputs / Outputs' (highlighted), 'Communications', and 'Save Settings'. The main area is divided into 'Basic' and 'Advanced' tabs. The 'Advanced' tab is active, showing a table with columns for 'TRIG Button', 'TUNE Button', 'Inputs', 'Outputs', 'Output Delay', 'Pulse Encoder', 'Height Sensor', and 'Custom LED'. The 'Custom LED' column has a dropdown menu open, showing a list of colors: 'Green', 'Red', 'Red', 'Red', 'Red', 'Red', 'Red'. The 'Green' option is selected. Below the table, there are several sliders and checkboxes for configuring the LED behavior, such as 'Enable Beeper on Good Read', 'Error LED Pulse Duration [ms]', 'Beep Length (ms)', 'Light Ring Pulse Duration [ms]', and 'Enable Out of Range Indication'.

Note:

If you choose the same color for the primary illumination and for the custom inputs/outputs LED, a warning appears next to the custom color. In this case, you either have to choose a different primary illumination color, or choose a different custom LED color for the inputs/outputs events.



This is a close-up of the 'Custom LED Color' dropdown menu. The menu is open, showing a list of color options: 'Green', 'Red', 'White', 'Red', 'Red', 'Red', 'Red'. The 'White' option is currently selected and highlighted with a grey background. A red box is drawn around the 'White' option, and a warning icon (an exclamation mark inside a triangle) is visible to the right of the 'White' option, indicating that this color is not allowed because it matches the primary illumination color.

Industrial Protocols

The reader supports the following industrial protocols:

- EtherNet/IP™, EDS and PLC
- PROFINET (Class B)
- SLMP Protocol
- Modbus TCP
- CC-Link

Select industrial protocol samples and tools you want to use when you install the DataMan Setup Tool.

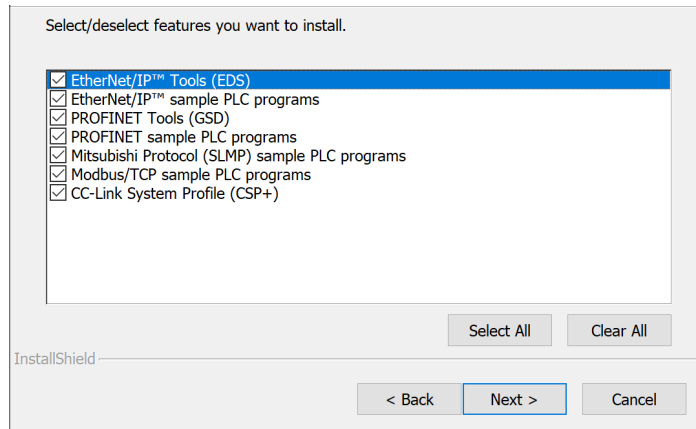

There are three ways to enable or disable industrial protocols. Once enabled, a reboot is required for the changes to take effect.

- Enable the protocols using the **Industrial Protocols** pane of the DataMan Setup Tool, under **Communications**.
- Scan the appropriate **Reader Configuration codes**. For more information, see *Reader Configuration Codes* available through the Windows **Start** menu, the DataMan Setup Tool **Help** menu, or DataMan documentation available on the [Cognex support site](#).
- Send the appropriate **DMCC** command. For more information, see *Command Reference* available through the Windows **Start** menu or the DataMan Setup Tool **Help** menu.

For more information on using the industrial protocols, see the **DataMan Industrial Protocols Manual** available through the Windows **Start** menu, the DataMan Setup Tool **Help** menu, or DataMan documentation available on the [Cognex support site](#).

Specifications

The following sections list general specifications for the reader.

DataMan 280 Series Reader

Specification	DataMan 280	DataMan 282
Weight	6.2 mm: 141 g 16 mm: 169 g Right angle configuration adds 50 g	HPIT: 290 g Right angle configuration adds 50 g
Power	24 V DC +/- 10%, PoE (Power over Ethernet)	24 V DC ± 10%
24 V Supply	24 V DC ± 10% LPS or NEC class 2	24 V DC ± 10%
	Power consumption without USB device attached: <ul style="list-style-type: none"> • Average ≤ 5 W using High-Powered Light • Average ≤ 6 W using High Frequency High-Powered Light • Peak ≤ 1.6 A using internal illumination 	Power consumption: <ul style="list-style-type: none"> • Average 5 W • Peak 10.7 W
Power over Ethernet Supply	PoE Class 3	N/A
Operating Temperature	0–40 °C (32–104 °F)	
Storage Temperature	-10–60 °C (14–140 °F)	
Humidity	<95% non-condensing	
Environmental	IP67	
	 Note: IP67 rating applies only if all blind plugs and cables are attached properly, or the provided connector plug is installed. Also, make sure that the IP67-rated cover is installed properly.	
Shock	IEC 60068-2-27 - 500 shocks in each polarity of each (X, Y, and Z) axis, 3000 shocks total, semi-sinusoidal, 11 g, 10 ms	
Shock (Shipping and Storage)	ISTA-1A Standardized Testing - Packaged Products 150 lb or less	
Vibration	IEC 60068-2-6: vibration test in each of the three main axis for 2 hours @ 10 Gs (10 to 500 Hz at 100m/s ² / 15 mm)	
Vibration (Shipping and Storage)	FedEx Vibration Testing for packaged products 150 lbs or less	
RS-232	RxD, TxD according to TIA/EIA-232-F	
Codes	1-D barcodes: Codabar, Code 39, Code 128, Code 93, Code 25, Interleaved 2 of 5, Postal Codes, UPC/EAN/JAN, MSI 2-D barcodes: Data Matrix (IDMax and IDQuick: ECC 0, 50, 80, 100, 140, and 200), QR Code, microQR, PDF 417, AztecCode, DotCode, MaxiCode	

Specification	DataMan 280	DataMan 282
High-Speed Outputs 0, 1, 2, 3	I_{MAX} : 50 mA	
	V_{OL} : $\leq \pm 3$ V @ 50 mA	
Inputs 0 (Trigger), 1, 2, 3	V_{IL} : $\leq \pm 6$ V	
	V_{IH} : $\geq \pm 12$ V	
	I_{TYP} : 4.2 mA @ 24 V	
Ethernet	10/100/1000. Full duplex or half duplex.	

DataMan 280 Series Reader Image Sensor

Specification	DataMan 280	DataMan 282
Image Sensor	1/3-inch CMOS, global shutter	1/3-inch CMOS, global shutter
Image Sensor Properties	Diagonal size: 6.21 mm Pixel size: 3.45 μ m (H) x 3.45 μ m (V)	Diagonal size: 6.17 mm Pixel size: 2.8 μ m (H) x 2.8 μ m (V)
Image Resolution (pixels)	1440 x 1080 (1.6 mp)	1920 x 1080 pixels (2 mp)
Electronic Shutter Speed	Minimum exposure: 43 μ s Maximum exposure: 200 ms (with external illumination)	Minimum exposure: 30 μ s Maximum exposure: 200 ms (with external illumination)
Image Acquisition at Full Resolution	Maximum: 45 Hz	
Lens Type	6.2 mm (3 pos or LLM) with IR blocking filter, 16 mm (manual or LLM) with IR blocking filter, 6.2 mm UV, 6.2 mm and 16 mm IR, C-Mount acc.	8 mm, 12 mm, 16 mm High Speed Liquid Lens

LED Wavelengths

The following table shows LED types and the related dominant wavelengths.

LED	λ [nm]
RED	617
RED HPIL	617
BLUE	470
WHITE	6500K (Color temperature)
IR	850
IR HPIL	850
UV	365

Acquisition Trigger Input

The reader features one acquisition trigger input, which is optically isolated. You can configure the acquisition trigger input to trigger from an NPN (current sinking) or PNP (current sourcing) device.

- To trigger from an NPN type photoelectric sensor or PLC output, connect COMMON IN to +24 VDC and connect IN 0 to the output of the photoelectric sensor. When the output turns ON, it pulls TRIGGER down to 0 VDC, turning the opto-coupler ON.
- To trigger from a PNP photoelectric sensor or PLC output, connect IN 0 to the output of the photoelectric sensor and connect COMMON IN to 0 VDC. When the output turns ON, it pulls TRIGGER up to +24 VDC, turning the opto-coupler ON.

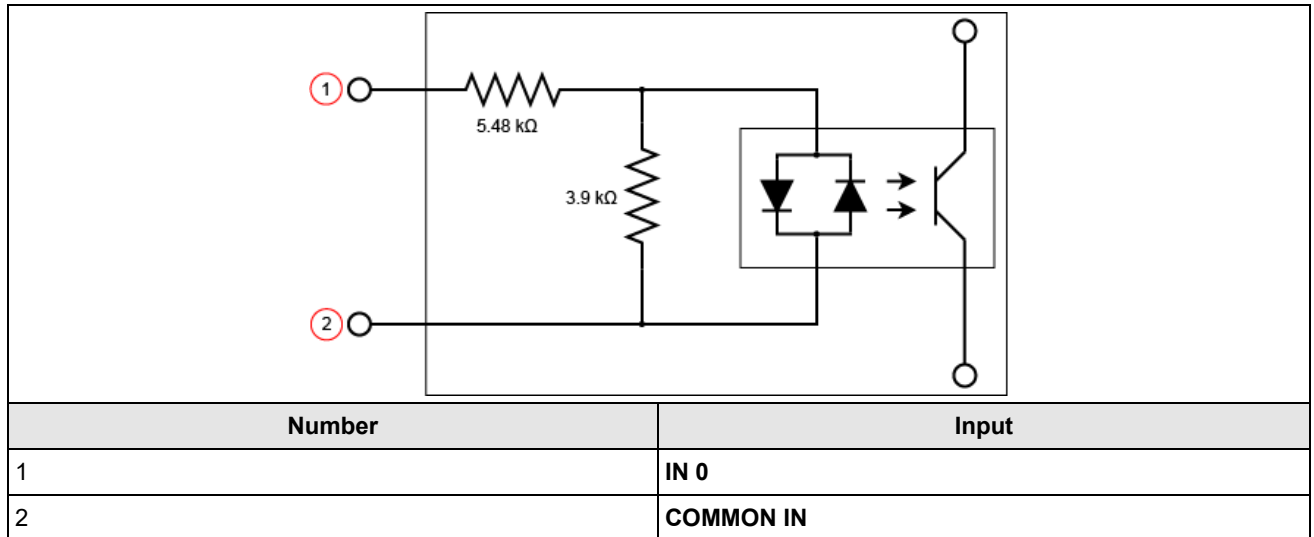

High-Speed Outputs

Specification	Description
Voltages	V_{MAX} : 26 VDC through external load V_{OL} : $\leq \pm 3$ V @ 50 mA
Current	I_{MAX} : 50 mA maximum sink or source current Each line is protected against over-current, short circuits and transients from switching inductive loads. High current inductive loads require an external protection diode.

For NPN lines, the external load should be connected between the output and the positive supply voltage (< 26 VDC). The output pulls down to less than 3 VDC when ON, which causes current to flow through the load. When the output is OFF, no current flows through the load.

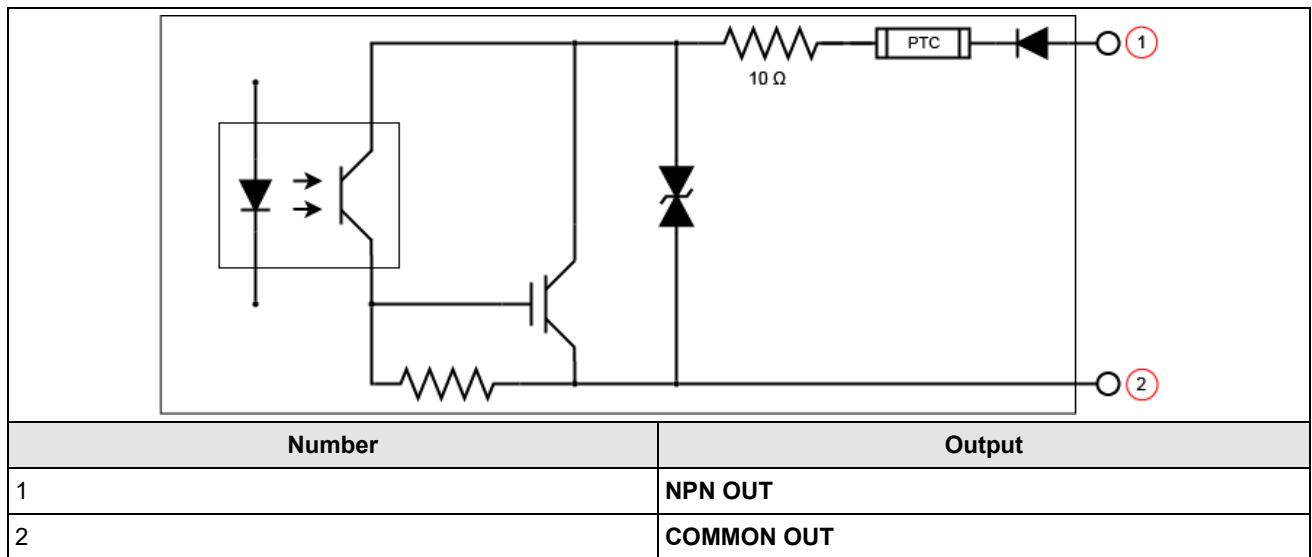

For PNP lines, the external load should be connected between the output and the negative supply voltage (0 VDC). When connected to a 24 VDC power supply, the output pulls up greater than 21 VDC when ON, and current flows through the load. When the output is OFF, no current flows through the load.

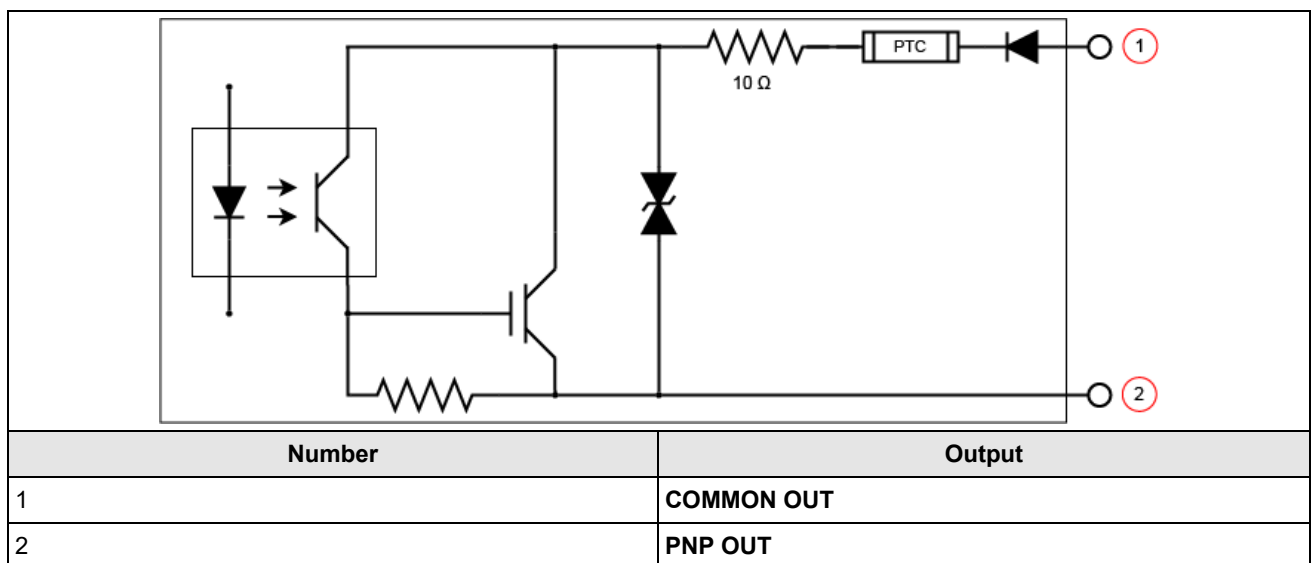

High Speed Output Wiring

To connect to an NPN-compatible PLC input, connect one of the reader's high-speed outputs directly to the PLC input. When enabled, the output pulls the PLC input down to less than 3 VDC.

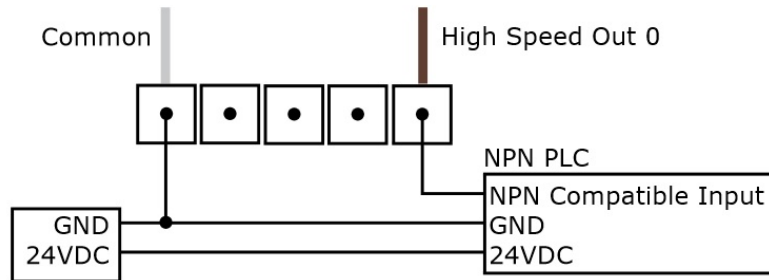

To connect to a PNP-compatible PLC input, connect one of the reader's high-speed outputs directly to the PLC input. When enabled, the output pulls the PLC input up to greater than 21 VDC.

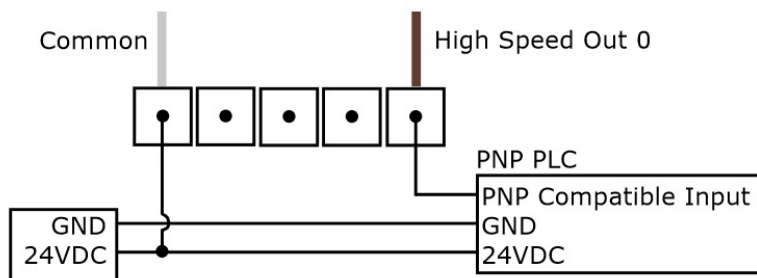

To connect the high-speed outputs to a relay, LED or similar load, connect the negative side of the load to the output and the positive side to +24VDC. When the output switches on, the negative side of the load is pulled down to less than 3 VDC, and 21 VDC appears across the load. Use a protection diode for a large inductive load, with the anode connected to the output and the cathode connected to +24 VDC.

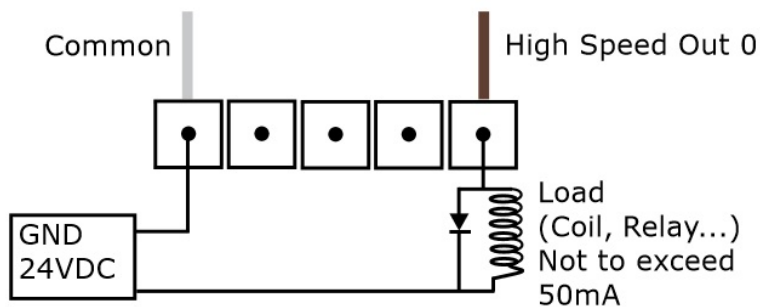

Ethernet Cable

The Ethernet cable provides Ethernet connectivity to the reader. The Ethernet cable is used to connect the reader to other network devices.

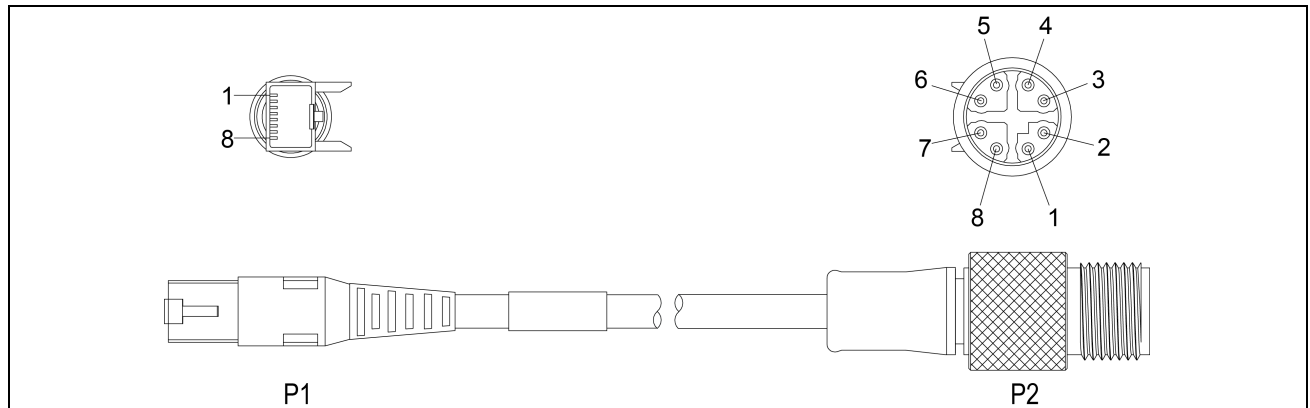

P1 Pin Number	Wire Color	Signal Name	P2 Pin Number
1	White/Orange	TxRx A +	1
2	Orange	TxRx A -	2
3	White/Green	TxRx B +	3
4	Blue	TxRx C +	8
5	White/Blue	TxRx C -	7
6	Green	TxRx B -	4
7	White/Brown	TxRx D +	5
8	Brown	TxRx D -	6

CAUTION: The Ethernet cable shield has to be grounded at the far end. Whatever this cable is plugged into (typically a switch or router) should have a grounded Ethernet connector. A digital voltmeter has to be used to validate the grounding. If the far end device is not grounded, a ground wire should be added in compliance with local electrical codes.

Note:

- Cables are sold separately.
- The wiring for this cable follows standard industrial Ethernet M12 specifications. It differs from the 568B standard.



CCB-M12x12Fy-xx

The Power and I/O Breakout cable provides access to trigger and high-speed outputs. For RS-232, use the Power Supply return path for ground.

The figure on the left shows the plug on the device.

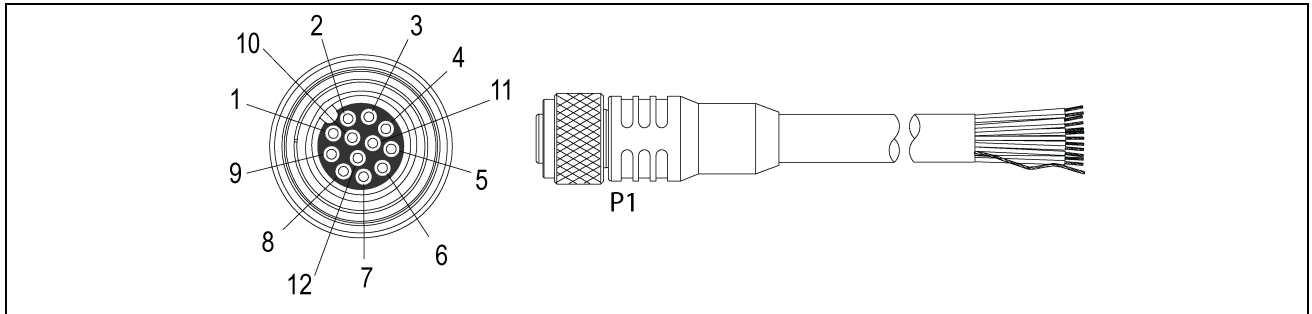

Pin#	Signal Names	Wire Color
1	Out 2/In 2	White
2	TxD	Green
3	RxD	Pink
4	Out 3/In 3	Yellow
5	In 1	Grey
6	Common In	Black
7	+24 VDC	Brown
8	GND	Blue
9	Common Out	Purple
10	In 0	Red
11	Out 0	Grey/Pink
12	Out 1	Red/Blue

Note:

- Cables are sold separately.
- Perform wiring or adjustments to I/O devices when the reader is not receiving power.
- You can cut exposed wires short or trim wire ends. You also can tie the wires back if you use a tie made of non-conductive material. Keep bare wires separated from the +24 V DC wire.



CCBL-05-01

The Power and I/O Breakout cable provides access to trigger and high-speed outputs. For RS-232, use the Power Supply return path for ground.

The figure on the left shows the plug on the device.

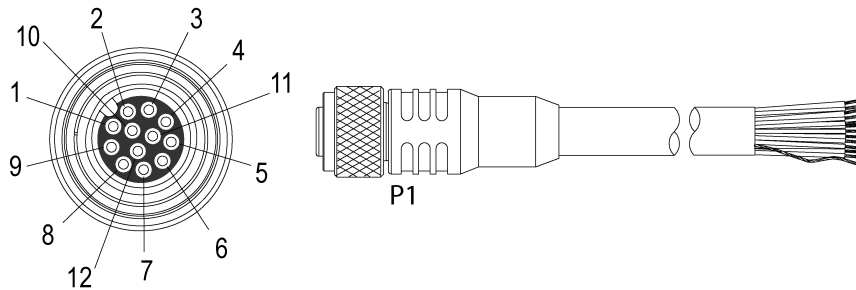

Pin#	Signal Names	Wire Color
1	Out 2/In 2	Yellow
2	TxD	White/Yellow
3	RxD	Brown
4	Out 3/In 3	White/Brown
5	In 1	Violet
6	Common In	White/Violet
7	+24 VDC	Red
8	GND	Black
9	Common Out	Green
10	In 0	Orange
11	Out 0	Blue
12	Out 1	Grey

Note:

- Cables are sold separately.
- i**
- Perform wiring or adjustments to I/O devices when the reader is not receiving power.
 - You can cut exposed wires short or trim wire ends. You also can tie the wires back if you use a tie made of non-conductive material. Keep bare wires separated from the +24 V DC wire.

CCB-PWRIO-05

The Power and I/O Breakout cable provides access to trigger and high-speed outputs. For RS-232, use the Power Supply return path for ground.

The figure on the left shows the plug on the device.

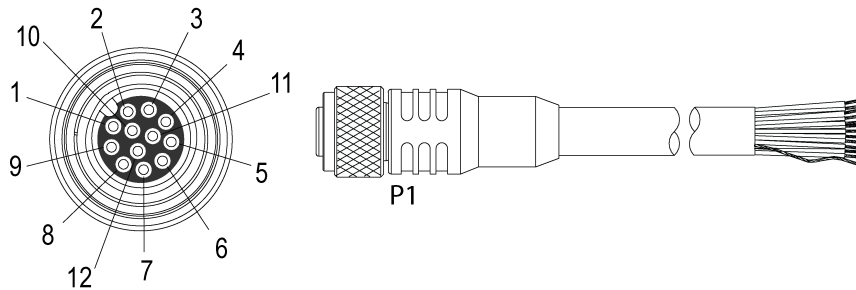

Pin#	Signal Names	Wire Color
1	Out 2/In 2	Yellow
2	TxD	White/Yellow
3	RxD	Brown
4	Out 3/In 3	White/Brown
5	In 1	Violet
6	Common In	White/Violet
7	+24 VDC	Red
8	GND	Black
9	Common Out	Green
10	In 0	Orange
11	Out 0	Blue
12	Out 1	Grey

Note:

- Cables are sold separately.
- i**
- Perform wiring or adjustments to I/O devices when the reader is not receiving power.
 - You can cut exposed wires short or trim wire ends. You also can tie the wires back if you use a tie made of non-conductive material. Keep bare wires separated from the +24 V DC wire.

Cleaning and Maintenance

Clean the Housing

To clean the outside of the reader housing, use a small amount of mild detergent cleaner or isopropyl alcohol on a cleaning cloth. Do not pour the cleaner on the reader housing.

 **CAUTION:** Do not attempt to clean any DataMan product with harsh or corrosive solvents, including lye, methyl ethyl ketone (MEK) or gasoline.

Clean the Reader Image Sensor Window

To remove dust from the outside of the image sensor window, use a pressurized air duster. The air must be free of oil, moisture or other contaminants that could remain on the glass and possibly degrade the image. Do not touch the glass window. If oil or smudges remain, use a cotton bud and alcohol (ethyl, methyl, or isopropyl) to clean the window. Do not pour the alcohol on the window.



Clean the Reader Lens Cover

To remove dust from the lens cover, use a pressurized air duster. The air must be free of oil, moisture or other contaminants that could remain on the lens cover. To clean the plastic window of the lens cover, use a small amount of isopropyl alcohol on a cleaning cloth. Do not scratch the plastic window. Do not pour the alcohol on the plastic window.

Regulations and Conformity

Note: For the most current CE and UKCA declarations and regulatory conformity information, see the Cognex support site: cognex.com/support.

DataMan 280 readers have Regulatory Model numbers 50208, 50210, 50215, 50216 and meet or exceed the requirements of all applicable standards organizations for safe operation. However, as with any electrical equipment, the best way to ensure safe operation is to operate them according to the agency guidelines that follow. Please read these guidelines carefully before using your device.

Safety and Regulatory	
Manufacturer	Cognex Corporation One Vision Drive Natick, MA 01760 USA
	This is a class A product. In a domestic environment this product may cause radio interference in which case the user may be required to take immediate measures. This equipment complies with the essential requirements of the EU Directive 2014/30/EU. Declarations are available from your local representative.
EU RoHS	Compliant to the most recent applicable directive.
FCC	FCC Part 15, Class A This equipment has been tested and found to comply with the limits for a Class A digital device, pursuant to part 15 of the FCC Rules. These limits are designed to provide reasonable protection against harmful interference when the equipment is operated in a commercial environment. This equipment generates, uses, and can radiate radio frequency energy and, if not installed and used in accordance with the instruction manual, may cause harmful interference to radio communications. Operation of this equipment in a residential area is likely to cause harmful interference in which case the user will be required to correct the interference at his own expense.
Korea 	This device is certified for office use only and if used at home, there can be frequency interference problems. A급 기기(업무용 방송통신기자재): 이 기기는 업무용(A급) 전자파적합기기로서 판매자 또는 사용자는 이 점을 주의하시기 바라며, 가정외의 지역에서 사용하는 것을 목적으로 합니다. DataMan280 1.6 MP: R-R-CGX-50208 DataMan 280 1.6 MP L-shaped: R-R-CGX-50210 DataMan 280 2 MP: R-R-CGX-50215 DataMan 280 2 MP L-shaped: R-R-CGX-50216
TÜV	DataMan 280 1.6 MP: Regulatory Model 50208 DataMan 280 1.6 MP L-shaped: Regulatory Model 50210 DataMan 280 2 MP: Regulatory Model 50215 DataMan 280 2 MP L-shaped: Regulatory Model 50216 NRTL: TÜV SÜD SCC/NRTL OSHA Scheme for UL/CAN 61010-1. CB report available upon request. TÜV SÜD, IEC/EN 61010-1.
UK	Regulatory Model 50208 Regulatory Model 50210 Regulatory Model 50215 Regulatory Model 50216 This is a class A product. In a domestic environment, this product can cause radio interference, in which case the user is required to take adequate measures. This equipment complies with the essential requirements of the Electromagnetic Compatibility Regulations 2016. Declarations are available from your local representative.

中国大陆RoHS (Information for China RoHS Compliance)

根据中国大陆《电子信息产品污染控制管理办法》(也称为中国大陆RoHS), 以下部份列出了本产品中可能包含的有毒有害物质或元素的名称和含量。



Part Name 部件名称	Hazardous Substances 有害物质					
	Lead (Pb) 铅	Mercury (Hg) 汞	Cadmium (Cd) 镉	Hexavalent Chromium (Cr (VI)) 六价铬	Polybrominated biphenyls (PBB) 多溴联苯	Polybrominated diphenyl ethers (PBDE) 多溴二苯醚
Regulatory Model 50215	X	O	O	O	O	O
Regulatory Model 50216						

This table is prepared in accordance with the provisions of SJ/T 11364.

这个标签是根据SJ/T 11364 的规定准备的。

O: Indicates that said hazardous substance contained in all of the homogeneous materials for this part is below the limit requirement of GB / T26572 - 2011.

表示本部件所有均质材料中含有的有害物质低于GB / T26572 - 2011 的限量要求。

X: Indicates that said hazardous substance contained in at least one of the homogeneous materials used for this part is above the limit requirement of GB / T26572 - 2011.

表示用于本部件的至少一种均质材料中所含的危害物质超过GB / T26572 - 2011 的限制要求。

For European Community Users

Cognex complies with Directive 2012/19/EU OF THE EUROPEAN PARLIAMENT AND OF THE COUNCIL of 4 July 2012 on waste electrical and electronic equipment (WEEE).

This product has required the extraction and use of natural resources for its production. It may contain hazardous substances that could impact health and the environment, if not properly disposed.

In order to avoid the dissemination of those substances in our environment and to diminish the pressure on the natural resources, we encourage you to use the appropriate take-back systems for product disposal. Those systems will reuse or recycle most of the materials of the product you are disposing in a sound way.



The crossed out wheeled bin symbol informs you that the product should not be disposed of along with municipal waste and invites you to use the appropriate separate take-back systems for product disposal.

If you need more information on the collection, reuse, and recycling systems, please contact your local or regional waste administration.

You may also contact your supplier for more information on the environmental performance of this product.

