

DataMan[®] 380 Series Quick Reference Guide



2023 November 16
Revision: 23.3.1.3

Precautions

To reduce the risk of injury or equipment damage, observe the following precautions when you install the Cognex product:

- Connectivity is possible through the following options:
 - 24 VDC (+/- 10%) output connection using a UL or NTRL listed power supply

Any other voltage creates a risk of fire or shock and can damage the components. Applicable national and local wiring standards and rules must be followed.

- This product is intended for industrial use in automated manufacturing or similar applications.
- The safety of any system incorporating this product is the responsibility of the assembler of the system.
- Do not install Cognex products where they are exposed to environmental hazards such as excessive heat, dust, moisture, humidity, impact, vibration, corrosive substances, flammable substances, or static electricity.
- Route cables and wires away from high-current wiring or high-voltage power sources to reduce the risk of damage or malfunction from the following causes: over-voltage, line noise, electrostatic discharge (ESD), power surges, or other irregularities in the power supply.
- Do not expose the image sensor to laser light. Image sensors can be damaged by direct, or reflected, laser light. If your application requires laser light that might strike the image sensor, use a lens filter at the corresponding laser wavelength. For suggestions, contact your local integrator or application engineer.

- This product does not contain user-serviceable parts. Do not make electrical or mechanical modifications to product components. Unauthorized modifications can void your warranty.
- Changes or modifications not expressly approved by the party responsible for regulatory compliance could void the user's authority to operate the equipment.
- Include service loops with cable connections.
- Ensure that the cable bend radius begins at least six inches from the connector. Cable shielding can be degraded or cables can be damaged or wear out faster if a service loop or bend radius is tighter than 10X the cable diameter.
- This device should be used in accordance with the instructions in this manual.
- All specifications are for reference purposes only and can change without notice.

Symbols

The following symbols indicate safety precautions and supplemental information:



WARNING: This symbol indicates a hazard that could cause death, serious personal injury or electrical shock.



CAUTION: This symbol indicates a hazard that could result in property damage.



Note: This symbol indicates additional information about a subject.





Tip: This symbol indicates suggestions and shortcuts that might not otherwise be apparent.





Accessories

You can purchase the following components separately. For a list of options and accessories, contact your local Cognex sales representative.



Lenses

Accessory	Product Number	Illustration
16 mm f6.5 Cognex High-res	CLN-C16F06-UR	
25 mm f6.5 Cognex High-res	CLN-C25F06-UR	
35 mm f6.5 Cognex High-res	CLN-C35F06-UR	
12 mm Var. Ap. Edmund Optics HP Series	LEC-86570	
16 mm Var. Ap. Edmund Optics HP Series	LEC-86571	
25 mm Var. Ap. Edmund Optics HP Series	LEC-86572	
35 mm Var. Ap. Edmund Optics HP Series	LEC-86573	
50 mm Var. Ap. Edmund Optics HP Series	LEC-86574	

Lens Covers







Accessory	Product Number	Illustration
45 mm Plastic Lens Cover Use with CLN-C16F06-UR or CLN-C25F06-UR.	COV-380-CMNT-45	
60 mm Plastic Lens Cover Use with LEC-86571 or LEC-86572.	COV-380-CMNT-60	
75 mm Plastic Lens Cover Use with LEC-86573.	COV-380-CMNT-75	
30 mm Lens Cover Extender	COV-7000-CMNT-LGX	







Mounting Brackets

Accessory	Product Number	Illustration
Pivot mounting bracket	DMBK-PIVOT-DM380	
U-shaped mounting bracket for use with HPIT	DMBK-PVT-HPIT-380	

Cables

i Note: Cables are sold separately.

Accessory	Product Number	Illustration
Ethernet Cable, X-coded M12-8 to RJ-45	CCB-84901-2001-xx (straight, xx specifies length: 2m, 5m, 10m, 15m, 30m)	
Ethernet Cable, X-coded M12-8 to RJ-45	CCB-84901-2002-xx (right-angled, xx specifies length: 2m, 5m, 10m)	
Ethernet Cable, Robotic X-Coded M12-8 to RJ-45	CCB-84901-2RBT-xx (straight, xx specifies length: 2m, 5m, 10m)	
X-Coded to A-Coded Ethernet cable adapter, 0.5 m	CCB-M12X8MS-XCAC	
Power and I/O Breakout Cable, M12-12 to Flying Lead	CCB-M12x12Fy-05 (y = straight/angled, xx specifies length)	
Power and I/O Breakout Cable, M12-12 to Flying Lead	CCBL-05-01	
Power and I/O Breakout Cable, M12-12 to Flying Lead	CCB-PWRIO- xx (straight, xx specifies length: 5m, 10m, 15m)	

Accessory	Product Number	Illustration
Power and I/O Breakout Cable, M12-12 to Flying Lead	CCB-PWRIO-xxR (right-angled, xx specifies length: 5m, 10m, 15m)	
I/O Module Cable M12-12 to DB15	CCB-PWRIO-MOD-xx (xx specifies length: 2m, 5m)	
USB Type C Cable to USB Type A, Straight, 2.5 m	DMA-STCBLE-IP65-25	
USB Type C Cable to USB Type A, Angled, 2.5 m	DMA-RTCBLE-IP65-25	
External Light Cable, Yellow	IVSL-5PM12-J300 IVSL-5PM12-J500 IVSL-5PM12-J1000 IVSL-5PM12-J2000	
External Light Cable, Black	IVSL-M12-NSB-300 IVSL-M12-NSB-1000 IVSL-M12-NSB-2000	



Note: This cable supports intensity control.



Note: This cable supports intensity control and is used with standard SVL lights.

Integrated Lights

Accessory	Illustration
High-Powered Integrated Torch (HPIT), red and white variants Please contact Cognex sales for more details.	

WARNING: High-Powered Integrated Torch devices equipped with a Time-of-Flight sensor, the device has been tested to be under the limits of a Class 1 Laser device.



CAUTION: High-Powered Integrated Torch devices equipped with a target aimer have been tested in accordance with IEC 60825-1. 3rd ed. 2014, and have been certified to be under the limits of a Class 2 Laser device.

LASER LIGHT - DO NOT STARE INTO
CLASS 2 LASER PRODUCT 515nm<1m
CLASSIFIED PER IEC 60825-1, Ed 3, 2



Complies with 21 CFR 1040.10 & 1040.11
with IEC 60825-1 Ed. 3, as described in
Laser Notice No. 56 May 8 2019



DataMan 380 Series Systems

	Omnidirectional 1D Codes	Omnidirectional 1D/2D Codes	Multi-Reader Sync	Resolution
DM3808QL	✓		✓	2840 × 2840
DM3808X		✓	✓	
DM3812QL	✓		✓	4096 × 3000
DM3812X		✓	✓	
DM3816QL	✓		✓	5320 × 3032
DM3816X		✓	✓	

Setting Up Your DataMan Reader

Read this section to learn how the reader connects to its standard components and accessories.

Note:

- Cables are sold separately.
- If a standard component is missing or damaged, immediately contact your Cognex Authorized Service Provider (ASP) or Cognex Technical Support.



CAUTION: All cable connectors are keyed to fit the connectors on the reader. Do not force the connections or damage may occur.

Reader Layout

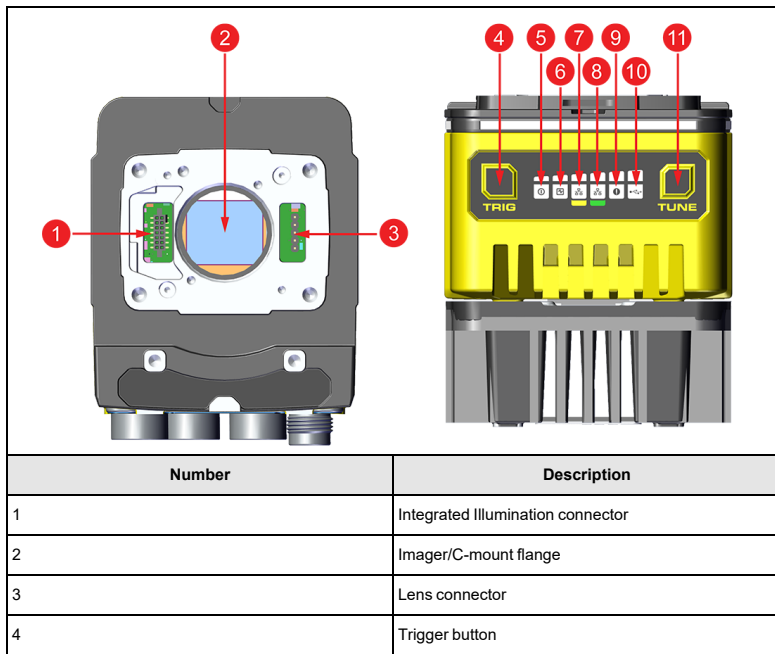

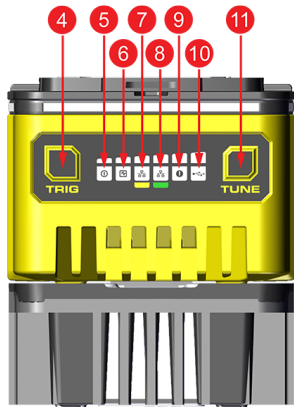
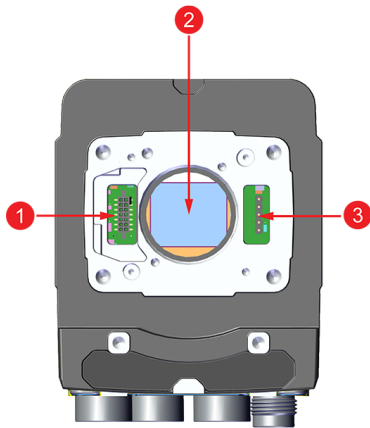

5	Power LED indicator
6	Train status LED indicator
7	Ethernet 0 status LED
8	Ethernet 1 status LED
9	Error LED indicator
10	Coglink/USB-C status LED
11	Tune button

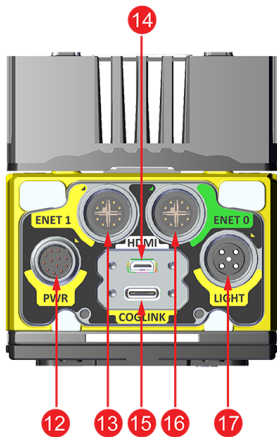

12	Power I/O Breakout cable connector
13	Ethernet connector 1
14	Micro-HDMI connector
15	Coglink/USB-C connector
16	Ethernet connector 0
17	Light connector
18	Indicator lights
19	Heatsink

Dimensions

The following sections list dimensions of the reader.

Note:



- Dimensions are in millimeters and are for reference purposes only.
- All specifications are for reference purposes only and can change without notice.

DataMan 380 Reader Only

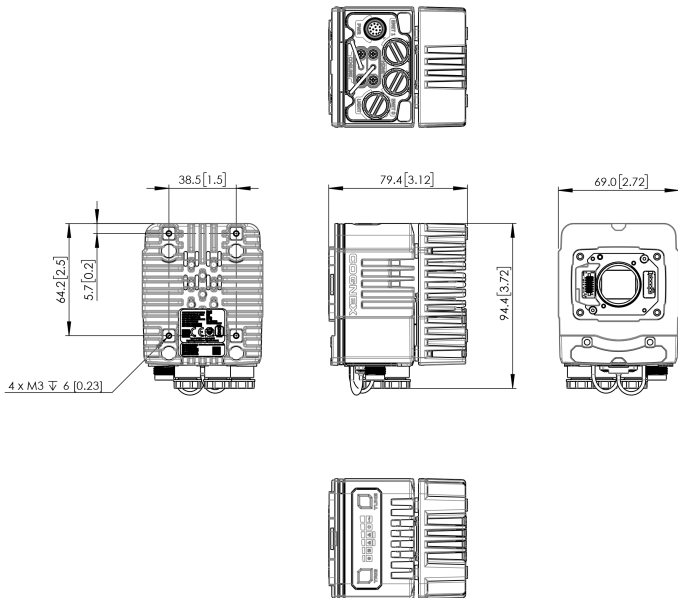

DataMan 380 with 45 mm Lens Cover

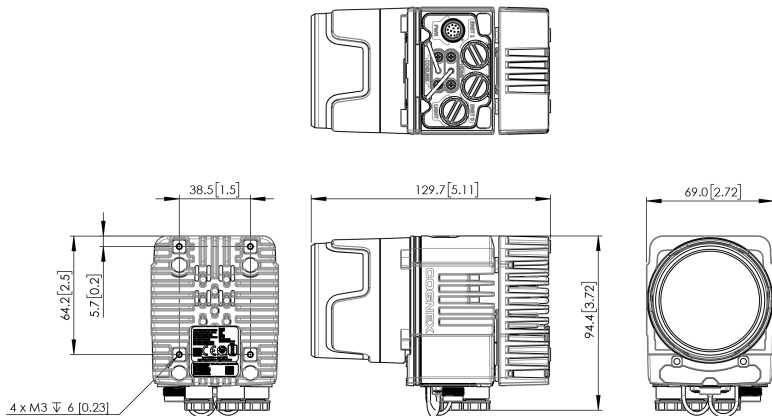

DataMan 380 with 60 mm Lens Cover

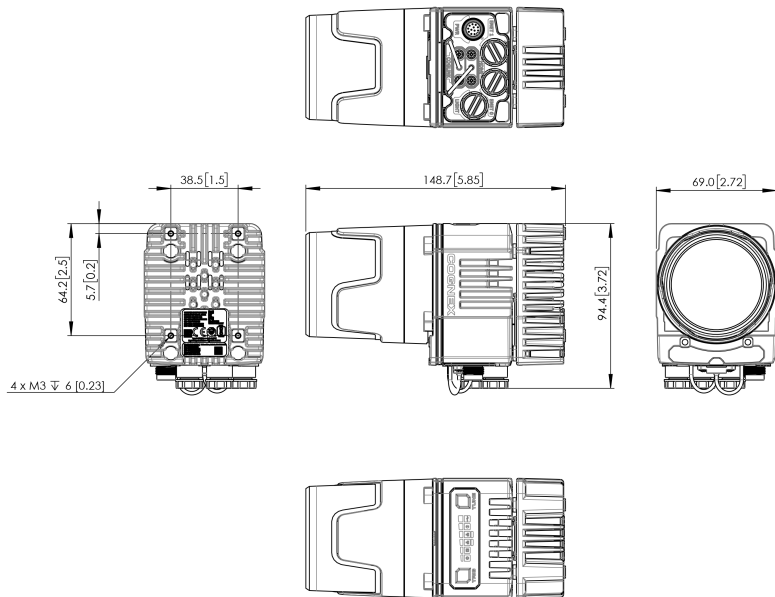

DataMan 380 with 75 mm Lens Cover

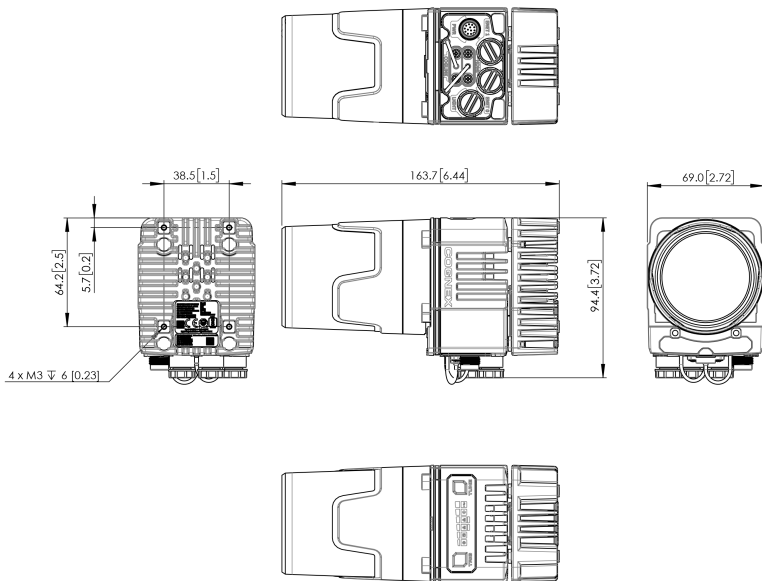

DataMan 380 with HPIT

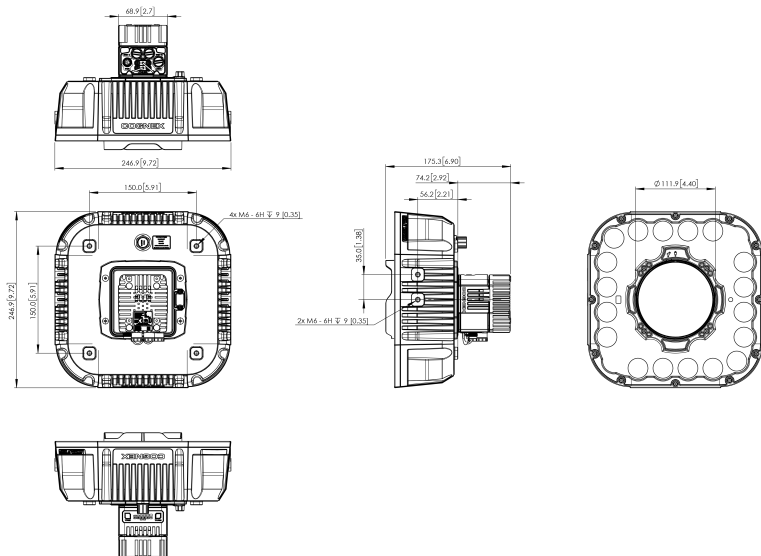

Field of View and Distance

This section provides the Field of View (FoV) values for 16 mm and 25 mm lenses.

DataMan 3808 Field of View

16 mm Focal Length

Working Distance in mm	Horizontal Values in mm	Vertical Values in mm
700	335	335
1200	575	575
1700	815	815

25 mm Focal Length

Working Distance in mm	Horizontal Values in mm	Vertical Values in mm
1200	365	365
1700	520	520
2200	675	675

DataMan 3812 Field of View

16 mm Focal Length

Working Distance in mm	Horizontal Values in mm	Vertical Values in mm
700	480	350
1200	830	610
1700	1180	865

25 mm Focal Length

Working Distance in mm	Horizontal Values in mm	Vertical Values in mm
1200	525	385
1700	750	550
2200	975	715

DataMan 3816 Field of View

16 mm Focal Length

Working Distance in mm	Horizontal Values in mm	Vertical Values in mm
700	625	355
1200	1080	615
1700	1535	875

25 mm Focal Length

Working Distance in mm	Horizontal Values in mm	Vertical Values in mm
1200	685	390
1700	975	555
2200	1270	720

Mounting the Reader

The reader provides mounting holes for attachment to a mounting surface.



CAUTION: The reader has to be grounded, either by mounting the reader to a fixture that is electrically grounded or by attaching a wire from the reader's mounting fixture to frame ground or Earth ground. If a ground wire is used, it has to be attached to one of the mounting points on the bottom plate of the reader and not to the mounting points on the front of the reader.

Note:



Mounting the reader at a slight angle (15°) reduces reflections and improves performance.

Mounting with Pivot Bracket

1. Align the pivot mounting bracket with the reader.

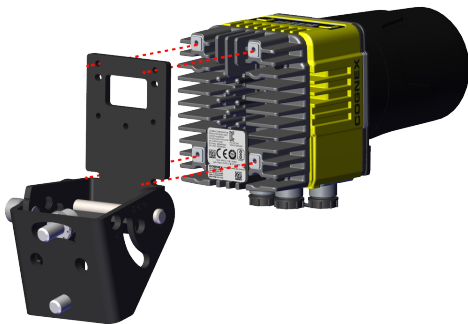

2. Insert the screws into the mounting pilot holes and tighten them.

 **Note:** Apply a maximum of 0.4 Nm torque when tightening the screws.

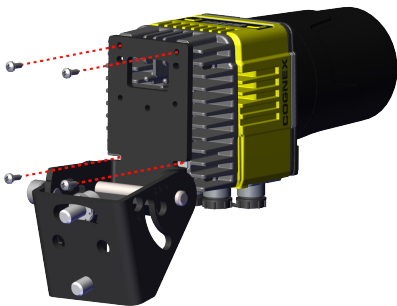

3. Place the reader on a mounting surface and tighten the screws.

Mounting with U-shaped Bracket for HPIT

1. Attach the pivot bracket to the frame.

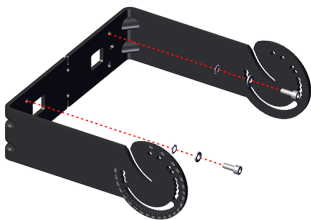

2. Insert the rotation axis screws without fully tightening them.

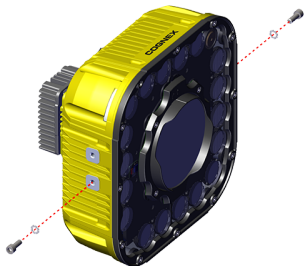

3. Slide the reader into the mounting bracket through the central slot.

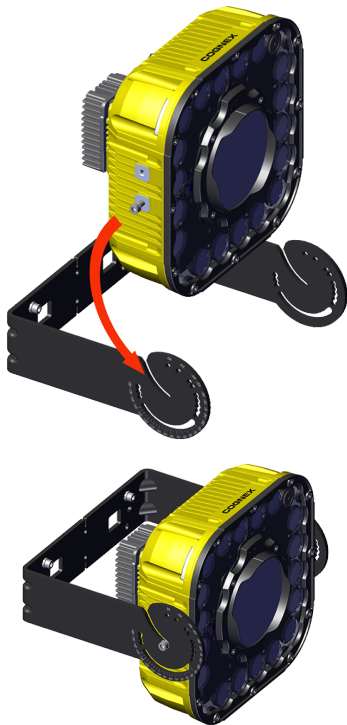

4. Apply the chosen rotation angle by inserting a screw into one of the preset holes or to the sliding slot on the mounting bracket.

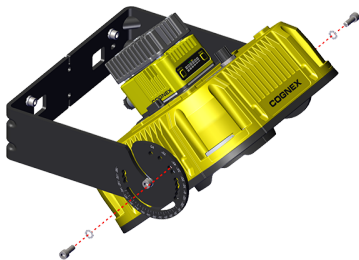

5. Tighten the mounting screws.

i **Note:** Apply a maximum of 5 Nm torque when tightening the screws.

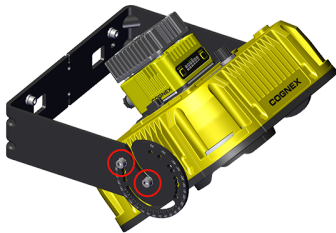

Connection Options

This section summarizes connection options.

Connecting the Ethernet Cable

CAUTION: The Ethernet cable shield has to be grounded at the far end. Whatever this cable is plugged into (typically a switch or router) should have a grounded Ethernet connector. A digital voltmeter has to be used to validate the grounding. If the far end device is not grounded, a ground wire should be added in compliance with local electrical codes.



1. Connect the M12 connector of the Ethernet cable to the green ENET0 connector of the reader.

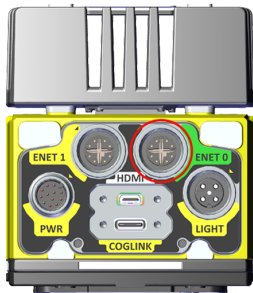

2. Connect the RJ-45 connector of the Ethernet cable to a switch, router, or PC.

Connecting the Power and I/O Breakout Cable



CAUTION: To reduce emissions, connect the far end of the Breakout cable shield to frame ground.

Note:



- Perform wiring or adjustments to I/O devices when the reader is not receiving power.
- You can clip unused wires short or use a tie made of non-conductive material to tie them back. Keep bare wires separated from the +24 V DC wire.

1. Verify that the 24 V DC power supply is unplugged and not receiving power.
2. Attach the +24 V DC connector of the Power and I/O Breakout cable and Ground wires to the corresponding terminals on the power supply. For more information, see *Specifications* on page 33.
3. Attach the M12 connector of the Power and I/O Breakout Cable to the 24 V DC connector of the reader.
4. Restore power to the 24 V DC power supply and turn it on if necessary.

Using your Device through USB

You can utilize the USB connector of the DataMan 380 for emulating serial (USB-COM) functionality.

For a detailed description, see the DataMan 380 Reference Manual.

Specifications

The following sections list general specifications for the reader.

DataMan 380 Series Reader

Specification	DataMan 380
Lens Type	C-Mount lens or Cognex High Speed Liquid Lens
Trigger	1 opto-isolated, acquisition trigger input.
Discrete Inputs	1 opto-isolated, acquisition trigger input. Up to 3 general-purpose inputs when connected to the Breakout cable. $V_{IL}: \leq \pm 6 \text{ V}$ $V_{IH}: \geq \pm 12 \text{ V}$ $I_{TYP}: 4.2 \text{ mA @ } 24 \text{ V}$
Discrete Outputs	Up to 4 outputs when connected to the Breakout cable. $I_{MAX}: 50 \text{ mA}$ $V_{OL}: \leq \pm 3 \text{ V @ } 50 \text{ mA}$
Status LEDs	Pass/Fail LED and Indicator Ring, Network LED, and Error LED.
Codes	1-D barcodes: Codabar, Code 39, Code 128, Code 93, Code 25, Interleaved 2 of 5, UPC/EAN/JAN 2-D barcodes: Data Matrix (ECC 0, 50, 80, 100, 140, and 200), QR Code, PDF 417, MaxiCode
Network Communication	2 Ethernet ports, 10/100/1000 BaseT with auto MDIX. IEEE 802.3 TCP/IP Protocol. Supports DHCP, static, and link-local IP address configuration. One port supports TSN networks. RS-232: Rx/D, Tx/D according to TIA/EIA-232-F

Specification	DataMan 380
Power Consumption	24 V DC +/- 10% LPS or NEC class 2 Power consumption without USB device attached: <ul style="list-style-type: none"> • Average ≤ 15 W without illumination • Average ≤ 40 W with illumination • Peak ≤ 2 A
Power Output	24 V DC at 1.0 A maximum to external light.
Material	Die-cast and extruded aluminum and zinc housing.
Finish	Painted.
Mounting	Four M3 threaded mounting holes. See <i>Mounting Brackets</i> on page 7 for supported mounts. Pattern: 38.5 × 58.5 mm (1.52 × 2.60 in)
Weight	DataMan 380 with no accessories attached: 775 g (27.3 oz). <ul style="list-style-type: none"> • with 45 mm plastic C-Mount cover (COV-380-CMNT-45): 830 g (29.3 oz) - no lens included. • with 60 mm plastic C-Mount cover (COV-380-CMNT-60): 840 g (29.6 oz) - no lens included. • with 75 mm plastic C-Mount cover (COV-380-CMNT-75): 855 g (30.1 oz) - no lens included. • with HPIT Illumination, High Speed Liquid Lens (16 mm), and standard front cover: 950 g (33.5 oz.).
Operational Temperature	0° C to 40° C (32° F to 122° F)
Storage Temperature	-20° C to 80° C (-4° F to 176° F)
Humidity	< 95% non-condensing

Specification	DataMan 380
Protection	IP67, altitude: 2000 m, indoor use only, pollution degree II
	 Note: IP67 rating applies only if all blind plugs and cables are attached properly, or the provided connector plug is installed. Also, make sure that the IP67-rated cover is installed properly.
Shock (Shipping and Storage)	IEC 60068-2-27 - 500 shocks in each polarity of each (X, Y, and Z) axis, 3000 shocks total, semi-sinusoidal, 11 g, 10 ms
Vibration (Shipping and Storage)	IEC 60068-2-6: vibration test in each of the three main axis for 2 hours at 10 Gs (10 to 500 Hz at 100 m/s ² / 15 mm) with cables or cable plugs and a 150 gram or lighter lens attached.
Regulations/Conformity	CE, FCC, KCC, TÜV SÜD NRTL, EU RoHS, China RoHS

DataMan 380 Series Reader Image Sensor

Specification	DM3808	DM3812	DM3816
Sensor Type	1/1.1-inch CMOS		1.1-inch CMOS
Image Sensor Properties	Diagonal size: 11.1 mm Pixel size: 2.74 µm (H) x 2.74 µm (V)	Diagonal size: 14 mm Pixel size: 2.74 µm (H) x 2.74 µm (V)	Diagonal size: 16.8 mm Pixel size: 2.74 µm (H) x 2.74 µm (V)
Maximum Image Resolution (pixels)	2840 × 2840 (8.06 mp)	4096 x 3000 (12.28 mp)	5320 x 3032 (16.13 mp)
Electronic Shutter Speed	Minimum exposure: 15 µs Maximum exposure: 200 ms		

Regulations and Conformity

i Note: For the most current CE and UKCA declarations and regulatory conformity information, see the Cognex support site: cognex.com/support.

DataMan 380 readers have Regulatory Model number 50103 and meet or exceed the requirements of all applicable standards organizations for safe operation. However, as with any electrical equipment, the best way to ensure safe operation is to operate them according to the agency guidelines that follow. Please read these guidelines carefully before using your device.

Safety and Regulatory	
Manufacturer	Cognex Corporation One Vision Drive Natick, MA 01760 USA
CE	DataMan 380 8 MP, 12 MP, 16 MP: Regulatory Model 50103 This is a class A product. In a domestic environment this product may cause radio interference in which case the user may be required to take immediate measures. This equipment complies with the essential requirements of the EU Directive 2014/30/EU. Declarations are available from your local representative.
EU RoHS	Compliant to the most recent applicable directive.
FCC	FCC Part 15, Class A This equipment has been tested and found to comply with the limits for a Class A digital device, pursuant to part 15 of the FCC Rules. These limits are designed to provide reasonable protection against harmful interference when the equipment is operated in a commercial environment. This equipment generates, uses, and can radiate radio frequency energy and, if not installed and used in accordance with the instruction manual, may cause harmful interference to radio communications. Operation of this equipment in a residential area is likely to cause harmful interference in which case the user will be required to correct the interference at his own expense.

Safety and Regulatory

<p>Korea</p> 	<p>This device is certified for office use only and if used at home, there can be frequency interference problems. A급 기기(업무용 방송통신기자재): 이 기기는 업무용(A급) 전자파적합기기로서 판매자 또는 사용자는 이 점을 주의하시기 바라며, 가정외의 지역에서 사용하는 것을 목적으로 합니다. DataMan 380 8 MP, 12 MP, 16 MP: R-R-CGX-50103</p>
<p>TÜV</p>	<p>DataMan 380 8 MP, 12 MP, 16 MP: Regulatory Model 50103</p> <p>NRTL: TÜV SÜD SCC/NRTL OSHA Scheme for UL/CAN 61010-1.</p> <p>CB report available upon request. TÜV SÜD, IEC/EN 61010-1.</p>
<p>UK</p>	<p>Regulatory Model 50103 This is a class A product. In a domestic environment, this product can cause radio interference, in which case the user is required to take adequate measures. This equipment complies with the essential requirements of the Electromagnetic Compatibility Regulations 2016. Declarations are available from your local representative.</p>

中国大陆RoHS (Information for China RoHS Compliance)

根据中国大陆《电子信息产品污染控制管理办法》(也称为中国大陆RoHS), 以下部份列出了本产品中可能包含的有毒有害物质或元素的名称和含量。



Hazardous Substances 有害物质						
Part Name 部件名称	Lead (Pb) 铅	Mercury (Hg) 汞	Cadmium (Cd) 镉	Hexavalent Chromium (Cr (VI)) 六价铬	Polybrominated biphenyls (PBB) 多溴联苯	Polybrominated diphenyl ethers (PBDE) 多溴二苯醚
Regulatory Model 50103	X	O	O	O	O	O
<p>This table is prepared in accordance with the provisions of SJ/T 11364. 这个标签是根据SJ/T 11364的规定准备的。</p> <p>O: Indicates that said hazardous substance contained in all of the homogeneous materials for this part is below the limit requirement of GB / T26572 - 2011. 表示本部件所有均质材料中含有的有害物质低于GB / T26572 - 2011的限量要求。</p> <p>X: Indicates that said hazardous substance contained in at least one of the homogeneous materials used for this part is above the limit requirement of GB / T26572 - 2011. 表示用于本部件的至少一种均质材料中所含的危害物质超过GB / T26572 - 2011的限制要求。</p>						

For European Community Users

Cognex complies with Directive 2012/19/EU OF THE EUROPEAN PARLIAMENT AND OF THE COUNCIL of 4 July 2012 on waste electrical and electronic equipment (WEEE).

This product has required the extraction and use of natural resources for its production. It may contain hazardous substances that could impact health and the environment, if not properly disposed.

In order to avoid the dissemination of those substances in our environment and to diminish the pressure on the natural resources, we encourage you to use the appropriate take-back systems for product disposal. Those systems will reuse or recycle most of the materials of the product you are disposing in a sound way.



The crossed out wheeled bin symbol informs you that the product should not be disposed of along with municipal waste and invites you to use the appropriate separate take-back systems for product disposal.

If you need more information on the collection, reuse, and recycling systems, please contact your local or regional waste administration.

You may also contact your supplier for more information on the environmental performance of this product.

Copyright © 2023
Cognex Corporation. All Rights Reserved.