

COGNEX

DataMan[®] 580 Series Quick Reference Guide



2023 September 22

Revision: 23.3.0.4

Precautions

To reduce the risk of injury or equipment damage, observe the following precautions when you install the Cognex product:

- Connectivity is possible through the following options:
 - 24 VDC (+/- 10%) output connection using a UL or NTRL listed power supply

Any other voltage creates a risk of fire or shock and can damage the components. Applicable national and local wiring standards and rules must be followed.

- This product is intended for industrial use in automated manufacturing or similar applications.
- The safety of any system incorporating this product is the responsibility of the assembler of the system.
- Do not install Cognex products where they are exposed to environmental hazards such as excessive heat, dust, moisture, humidity, impact, vibration, corrosive substances, flammable substances, or static electricity.
- Route cables and wires away from high-current wiring or high-voltage power sources to reduce the risk of damage or malfunction from the following causes: over-voltage, line noise, electrostatic discharge (ESD), power surges, or other irregularities in the power supply.
- Do not expose the image sensor to laser light. Image sensors can be damaged by direct, or reflected, laser light. If your application requires laser light that might strike the image sensor, use a lens filter at the corresponding laser wavelength. For suggestions, contact your local integrator or application engineer.

- This product does not contain user-serviceable parts. Do not make electrical or mechanical modifications to product components. Unauthorized modifications can void your warranty.
- Changes or modifications not expressly approved by the party responsible for regulatory compliance could void the user's authority to operate the equipment.
- Include service loops with cable connections.
- Ensure that the cable bend radius begins at least six inches from the connector. Cable shielding can be degraded or cables can be damaged or wear out faster if a service loop or bend radius is tighter than 10X the cable diameter.
- This device should be used in accordance with the instructions in this manual.
- All specifications are for reference purposes only and can change without notice.

Symbols

The following symbols indicate safety precautions and supplemental information:



WARNING: This symbol indicates a hazard that could cause death, serious personal injury or electrical shock.



CAUTION: This symbol indicates a hazard that could result in property damage.



Note: This symbol indicates additional information about a subject.





Tip: This symbol indicates suggestions and shortcuts that might not otherwise be apparent.

Accessories

You can purchase the following components separately. For a list of options and accessories, contact your local Cognex sales representative.







Kits



Kit	Product Number	Illustration
<p>MVT Spares: 25 mm lens kit</p> <ul style="list-style-type: none">• 25 mm Cognex lens, focused and 3D calibrated• Lens cover• DataMan 5809	<p>DM5809QL-MVT13 DM5809X-MVT13</p>	 An illustration showing two lens kits. On the left is a 25 mm lens kit, consisting of a black lens with a yellow ring and a small black lens cover. On the right is a 35 mm lens kit, consisting of a larger black lens with a yellow ring and a black lens cover. Both kits are shown next to a yellow and black Cognex DataMan camera unit.
<p>MVT Spares: 35 mm lens kit</p> <ul style="list-style-type: none">• 35 mm Cognex lens, focused and 3D calibrated• Lens cover• DataMan 5809	<p>DM5809QL-MVT10 DM5809X-MVT10</p>	

Kit	Product Number	Illustration
<p>DataMan 5809 with 16 mm lens kit</p> <ul style="list-style-type: none"> • 16 mm Cognex lens, user-specified focus distance, 3D calibrated • Lens cover • DataMan 5809 	<p>Contact a Cognex sales representative for custom DataMan 5809 configurations.</p>	
<p>DataMan 5809 with 25 mm lens kit</p> <ul style="list-style-type: none"> • 25 mm Cognex lens, user-specified focus distance, 3D calibrated • Lens cover • DataMan 5809 		
<p>DataMan 5809 with 35 mm lens kit</p> <ul style="list-style-type: none"> • 35 mm Cognex lens, user-specified focus distance, 3D calibrated • Lens cover • DataMan 5809 		



Cables

i Note: Cables are sold separately.

Accessory	Product Number	Illustration
Ethernet Cable, X-coded M12-8 to RJ-45	CCB-84901-2001-xx (straight, xx specifies length: 2m, 5m, 10m, 15m, 30m)	
Ethernet Cable, X-coded M12-8 to RJ-45	CCB-84901-2002-xx (right-angled, xx specifies length: 2m, 5m, 10m)	
Ethernet Cable, Robotic X-Coded M12-8 to RJ-45	CCB-84901-2RBT-xx (straight, xx specifies length: 2m, 5m, 10m)	
X-Coded to A-Coded Ethernet cable adapter, 0.5 m	CCB-M12X8MS-XCAC	
Power and I/O Extension Cable, M12-12 to M12-12	CKR-200-CBL-EXT	
Power and I/O Breakout Cable, M12-12 to Flying Lead	CCB-M12x12Fy-05 (y = straight/angled, xx specifies length)	
Power and I/O Breakout Cable, M12-12 to Flying Lead	CCBL-05-01	

Accessory	Product Number	Illustration
Power and I/O Breakout Cable, M12-12 to Flying Lead	CCB-PWRIO- xx (straight, xx specifies length: 5m, 10m, 15m)	
Power and I/O Breakout Cable, M12-12 to Flying Lead	CCB-PWRIO-xxR (right-angled, xx specifies length: 5m, 10m, 15m)	

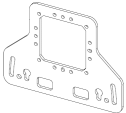
Mounting Brackets

Accessory	Product Number	Illustration
Flat Bracket	DMBK-FLAT-580	
Pivot Bracket	DMBK-PIVOT-580	

DataMan 580 Systems

	Code Reading	Multi-Reader Sync	Resolution
DM5809-QL	Omnidirectional 1D Codes	✓	4096 x 2160
DM5809-X	Omnidirectional 1D/2D Codes	✓	

Setting Up Your DataMan Reader

Read this section to learn how the reader connects to its standard components and accessories.

Note:

- Cables are sold separately.
- If a standard component is missing or damaged, immediately contact your Cognex Authorized Service Provider (ASP) or Cognex Technical Support.



CAUTION: All cable connectors are keyed to fit the connectors on the reader. Do not force the connections or damage may occur.

Reader Layout

The image and table below shows the elements of the reader.



Number	Description
1	Power I/O Breakout cable connector
2	Ethernet connector 0 (default interface)
3	USB-C slot (with plastic cover)
4	Ethernet connector 1
5	Light connector
6	Connector orientation locking screw

The following image and table shows the buttons and LEDs.

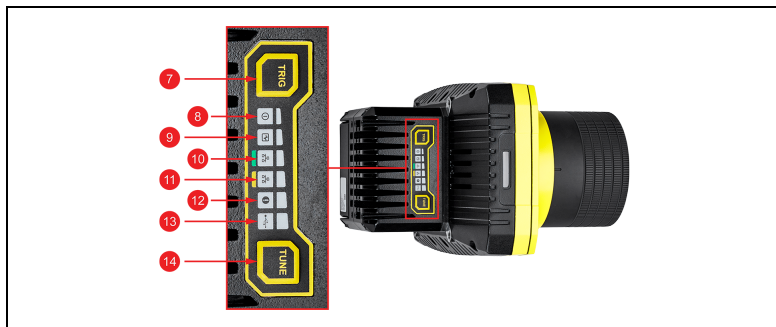

Number	Description
7	Trigger button
8	Power LED indicator
9	Train status LED indicator
10	Ethernet 0 status LED
11	Ethernet 1 status LED
12	Error LED indicator
13	USB-C status LED
14	Tune button

Dimensions

The following sections list dimensions of the reader.

Note:



- Dimensions are in millimeters and are for reference purposes only.
- All specifications are for reference purposes only and can change without notice.

DataMan 580 Dimensions

The following images show the dimensions of DataMan 580.

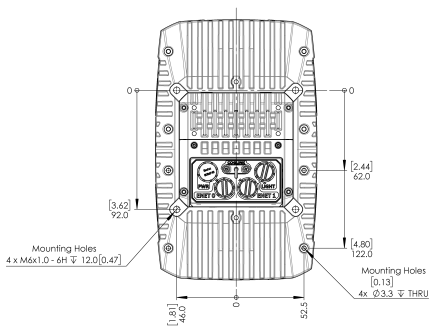
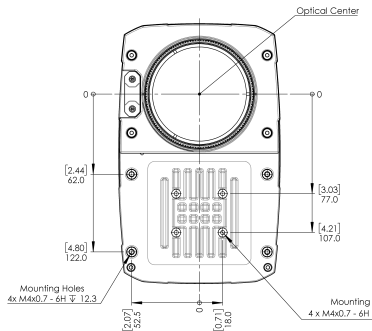

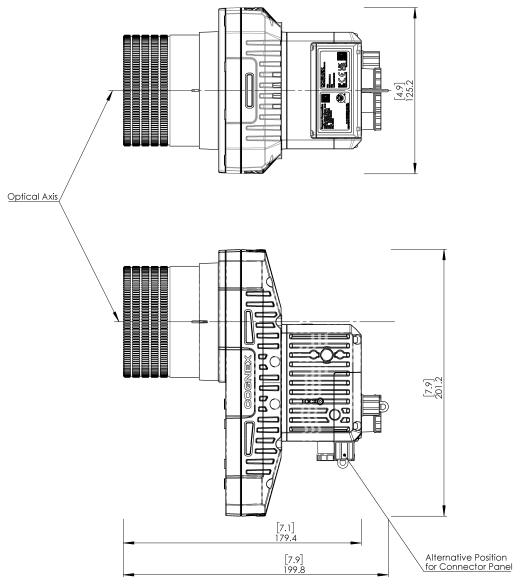

Field of View and Distance

This section provides the Field of View (FoV) values for 16 mm, 25 mm, and 35 mm lenses.

DataMan 580 Readers with 16 mm lens

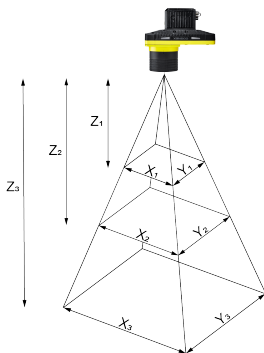

The following table lists the FoV values of a DataMan 5809 with 16 mm lens:

Working Distance in mm	Horizontal FoV in mm	Vertical FoV in mm
$Z_1 = 900$	$X_1 = 640$	$Y_1 = 335$
$Z_2 = 1200$	$X_2 = 850$	$Y_2 = 450$
$Z_3 = 1600$	$X_3 = 1135$	$Y_3 = 600$

DataMan 580 Readers with 25 mm Lens

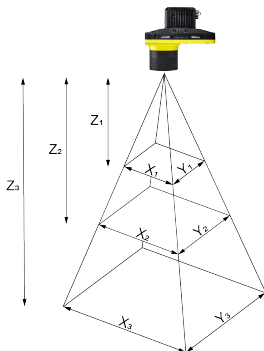

The following table lists the FoV values of a DataMan 5809 with 25 mm lens:

Working Distance in mm	Horizontal FoV in mm	Vertical FoV in mm
$Z_1 = 1700$	$X_1 = 770$	$Y_1 = 405$
$Z_2 = 2100$	$X_2 = 950$	$Y_2 = 500$
$Z_3 = 2500$	$X_3 = 1130$	$Y_3 = 595$

DataMan 580 Readers with 35 mm Lens

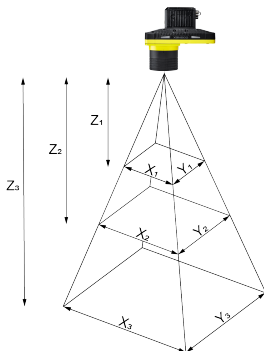

The following table lists the FoV values of a DataMan 5809 with 35 mm lens:

Working distance in mm	Horizontal FoV in mm	Vertical FoV in mm
$Z_1 = 1800$	$X_1 = 575$	$Y_1 = 300$
$Z_2 = 2400$	$X_2 = 770$	$Y_2 = 405$
$Z_3 = 2700$	$X_3 = 865$	$Y_3 = 460$

Mounting the Reader

The reader provides mounting holes for attachment to a mounting surface.



CAUTION: The reader has to be grounded, either by mounting the reader to a fixture that is electrically grounded or by attaching a wire from the reader's mounting fixture to frame ground or Earth ground. If a ground wire is used, it has to be attached to one of the mounting points on the bottom plate of the reader and not to the mounting points on the front of the reader.

Note:



Mounting the reader at a slight angle (15°) reduces reflections and improves performance.

Mounting with Pivot Bracket

The mounting kit includes:

- 1x DataMan 580 pivot bracket camera side
- 1x DataMan 580 pivot bracket frame side
- 2x threaded dowel pins
- 4x M6X16 screws
- 2x M6X12 screws
- 2x M8X16 screws
- 2x M8 flat washers
- 2x M8 split lock washers

- 6x M6 flat washers
- 6x M6 split lock washers

Assembly Instructions

1. Align the frame side pivot bracket with the frame. Place an M8 flat washer and an M8 split lock washer on each of the frame mounting holes. Put the M8 flat washers first. Insert the two M8x16 screws into the frame mounting holes. Screw the bracket to the frame using an 8 mm hex wrench.



Note: The symbols on each side of the bracket show the orientation of the reader after the assembly, and the angles where you can point the reader.

2. Insert the two M4 threaded dowel pins into the small bracket mounting holes on the reader. Use a flat screw driver to tighten them. Align the holes on the pivot bracket with the dowel pins and bracket mounting holes on the reader.



3. Place the four M6 flat washers and the four M6 split lock washers, one on each of the device mounting holes. The M6 flat washers go first. Insert the four M6X16 screws into the bracket mounting holes. Use a 6 mm hex wrench to tighten them.



4. If you need to rotate the I/O module, see *Rotating the I/O Module* on page 29.
5. Slide the two mounting bracket sides together, align the arrows on the two parts. Push the camera side bracket in the direction of the arrow and rotate it so the two parts align horizontally.

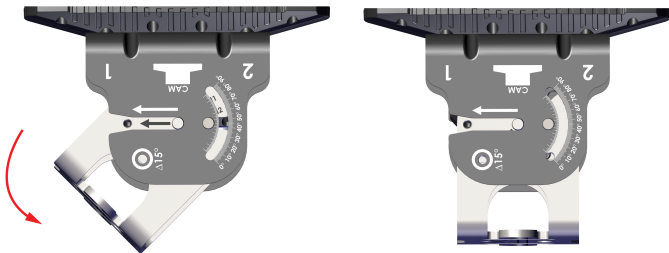

6. Rotate the camera so it points at the target.

7. Fix the bracket in place with one of the following methods:

- Use the delta 15° holes to fix in increments of 15°.
- Put a screw directly into the angle scale.

In both cases, place one M6 flat washers and one M6 split lock washers on each of the two holes. The M6 flat washers are first. Insert the two M6X12 screws into the holes. Use a 6 mm hex wrench to tighten them.

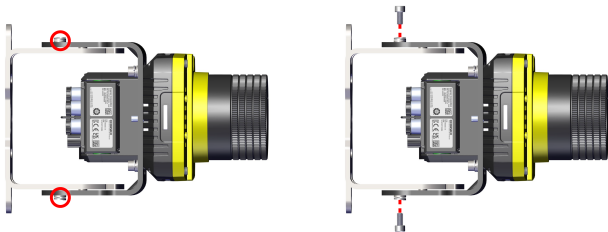

Mounting with Flat Bracket

The mounting kit includes:

- 1x DataMan 580 flat bracket
- 2x M4 threaded dowel pins
- 4x M6X16 screws
- 2x M8x16 screws
- 2x M8 flat washers
- 2x M8 split lock washers
- 4x M6 flat washers
- 4x M6 split lock washers

Assembly Instructions

1. Insert the two M4 threaded dowel pins into the small bracket mounting holes on the reader. Use a flat screw driver to tighten them. Align the holes on the flat bracket with the dowel pins and bracket mounting holes on the reader.

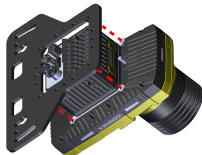
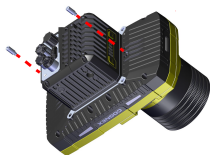

2. Place the four M6 flat washers and the four M6 split lock washers, one on each of the device mounting holes. The M6 flat washers go first. Insert the four M6X16 screws into the bracket mounting holes. Use a 6 mm hex wrench to tighten them.

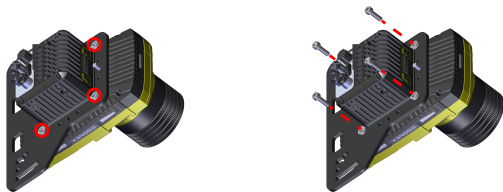

3. If you need to rotate the I/O module, see *Rotating the I/O Module* on page 29.
4. Place an M8 flat washer and an M8 split lock washer on each of the frame mounting holes. Put the M8 flat washers first. Insert the M8x16 screws into the frame mounting holes.



5. Screw the device to the frame using an 8 mm hex wrench.

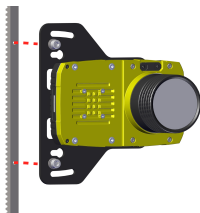

Connecting the Ethernet Cable

CAUTION: The Ethernet cable shield has to be grounded at the far end. Whatever this cable is plugged into (typically a switch or router) should have a grounded Ethernet connector. A digital voltmeter has to be used to validate the grounding. If the far end device is not grounded, a ground wire should be added in compliance with local electrical codes.



1. Connect the M12 connector of the Ethernet cable to the green ENET0 connector of the reader.



Connecting the Power and I/O Breakout Cable



CAUTION: To reduce emissions, connect the far end of the Breakout cable shield to frame ground.

Note:



- Perform wiring or adjustments to I/O devices when the reader is not receiving power.
 - You can clip unused wires short or use a tie made of non-conductive material to tie them back. Keep bare wires separated from the +24 V DC wire.
-
1. Verify that the 24 V DC power supply is unplugged and not receiving power.
 2. Attach the +24 V DC connector of the Power and I/O Breakout cable and Ground wires to the corresponding terminals on the power supply. For more information, see *Specifications* on page 30.
 3. Attach the M12 connector of the Power and I/O Breakout Cable to the 24 V DC connector of the reader.
 4. Restore power to the 24 V DC power supply and turn it on if necessary.

Rotating the I/O Module

i Note: Mount the reader before rotating the I/O module.

Instructions:

1. Unlock the I/O module with a 1.5 mm hex key and rotate the I/O module. The only supported alternative position is 90° down.

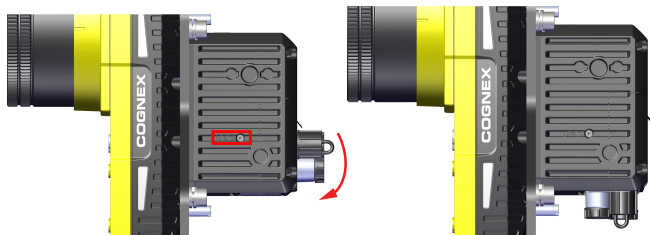

2. Lock the I/O module with a 1.5 mm hex key.

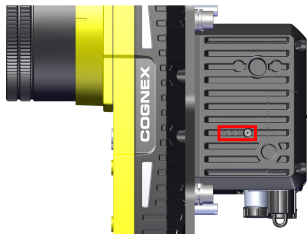

Using your Device through USB

You can utilize the USB connector of the DataMan 580 for emulating serial (USB-COM) functionality.

Specifications

The following sections list general specifications for the reader.

DataMan 580 Series Reader

Specification	DataMan 580
Operating Temperature	0–40 °C (32–104 °F)
Storage Temperature	-10–60 °C (14–140 °F)
Humidity	<95% non-condensing
Weight	With 35 mm F6 lens: 1780 g
Power	24 V DC \pm 10% LPS or NEC class 2 Power consumption without USB device attached: <ul style="list-style-type: none">• Average < 15W without illumination• Average < 40W w. Illumination• Peak < 2A

Specification	DataMan 580
Environmental	IP67, altitude: 2000 m, indoor use only, pollution degree II
	 Note: IP67 rating applies only if all blind plugs and cables are attached properly, or the provided connector plug is installed. Also make sure that the IP67-rated cover is installed properly.
Codes	1-D barcodes: Codabar, Code 39, Code 128, Code 93, Code 25, Interleaved 2 of 5, UPC/EAN/JAN 2-D barcodes: Data Matrix (IDMax and IDQuick: ECC 0, 50, 80, 100, 140, and 200), QR Code, PDF 417, MaxiCode

DataMan 580 Series Reader Image Sensor

Specification	DataMan 580
Image Sensor	2/3-inch CMOS, global shutter
	 Note: Requires >1 inch lensing.
Image Sensor Properties	Diagonal size: 12.96 mm Pixel size: 2.8 μ m (H) x 2.8 μ m (V)
Image Resolution (pixels)	4096 x 2160
Electronic Shutter Speed	Minimum exposure: 27 μ s Maximum exposure: 400 ms (with external illumination)
Lens Type	Manual focus: <ul style="list-style-type: none"> • 25 mm F6.5 • 35 mm F6 • 16 mm F6

Regulations and Conformity

i Note: For the most current CE and UKCA declarations and regulatory conformity information, see the Cognex support site: cognex.com/support.

DataMan 580 readers have Regulatory Model number 50114 and meet or exceed the requirements of all applicable standards organizations for safe operation. However, as with any electrical equipment, the best way to ensure safe operation is to operate them according to the agency guidelines that follow. Please read these guidelines carefully before using your device.

Safety and Regulatory	
Manufacturer	Cognex Corporation One Vision Drive Natick, MA 01760 USA
CE	DataMan 580 9 MP: Regulatory Model 50114 This is a class A product. In a domestic environment this product may cause radio interference in which case the user may be required to take immediate measures. This equipment complies with the essential requirements of the EU Directive 2014/30/EU. Declarations are available from your local representative.
EU RoHS	Compliant to the most recent applicable directive.
FCC	FCC Part 15, Class A This equipment has been tested and found to comply with the limits for a Class A digital device, pursuant to part 15 of the FCC Rules. These limits are designed to provide reasonable protection against harmful interference when the equipment is operated in a commercial environment. This equipment generates, uses, and can radiate radio frequency energy and, if not installed and used in accordance with the instruction manual, may cause harmful interference to radio communications. Operation of this equipment in a residential area is likely to cause harmful interference in which case the user will be required to correct the interference at his own expense.

Safety and Regulatory

<p>Korea</p> 	<p>This device is certified for office use only and if used at home, there can be frequency interference problems. A급 기기(업무용 방송통신기자재): 이 기기는 업무용(A급) 전자파적합기기로서 판매자 또는 사용자는 이 점을 주의하시기 바라며, 가정외의 지역에서 사용하는 것을 목적으로 합니다. DataMan 580 9 MP: R-R-CGX-50114</p>
<p>TÜV</p>	<p>DataMan 580 9 MP: Regulatory Model 50114</p> <hr/> <p>NRTL: TÜV SÜD SCC/NRTL OSHA Scheme for UL/CAN 61010-1.</p> <hr/> <p>CB report available upon request. TÜV SÜD, IEC/EN 61010-1.</p>
<p>UK</p>	<p>Regulatory Model 50114 This is a class A product. In a domestic environment, this product can cause radio interference, in which case the user is required to take adequate measures. This equipment complies with the essential requirements of the Electromagnetic Compatibility Regulations 2016. Declarations are available from your local representative.</p>

中国大陆RoHS (Information for China RoHS Compliance)

根据中国大陆《电子信息产品污染控制管理办法》(也称为中国大陆RoHS), 以下部份列出了本产品中可能包含的有毒有害物质或元素的名称和含量。



Hazardous Substances 有害物质						
Part Name 部件名称	Lead (Pb) 铅	Mercury (Hg) 汞	Cadmium (Cd) 镉	Hexavalent Chromium (Cr (VI)) 六价铬	Polybrominated biphenyls (PBB) 多溴联苯	Polybrominated diphenyl ethers (PBDE) 多溴二苯醚
Regulatory Model 50114	X	O	O	O	O	O
<p>This table is prepared in accordance with the provisions of SJ/T 11364. 这个标签是根据SJ/T 11364的规定准备的。</p> <p>O: Indicates that said hazardous substance contained in all of the homogeneous materials for this part is below the limit requirement of GB/T26572-2011. 表示本部件所有均质材料中含有的有害物质低于GB/T26572-2011的限量要求。</p> <p>X: Indicates that said hazardous substance contained in at least one of the homogeneous materials used for this part is above the limit requirement of GB/T26572-2011. 表示用于本部件的至少一种均质材料中所含的危害物质超过GB/T26572-2011的限制要求。</p>						

For European Community Users

Cognex complies with Directive 2012/19/EU OF THE EUROPEAN PARLIAMENT AND OF THE COUNCIL of 4 July 2012 on waste electrical and electronic equipment (WEEE).

This product has required the extraction and use of natural resources for its production. It may contain hazardous substances that could impact health and the environment, if not properly disposed.

In order to avoid the dissemination of those substances in our environment and to diminish the pressure on the natural resources, we encourage you to use the appropriate take-back systems for product disposal. Those systems will reuse or recycle most of the materials of the product you are disposing in a sound way.



The crossed out wheeled bin symbol informs you that the product should not be disposed of along with municipal waste and invites you to use the appropriate separate take-back systems for product disposal.

If you need more information on the collection, reuse, and recycling systems, please contact your local or regional waste administration.

You may also contact your supplier for more information on the environmental performance of this product.

Copyright © 2023
Cognex Corporation. All Rights Reserved.