

DataMan[®] 260 Series Quick Reference Guide

2023 July 06
Revision: 23.2.1.1



Precautions

To reduce the risk of injury or equipment damage, observe the following precautions when you install the Cognex product:

- This device requires the use of an LPS or NEC class 2 power supply (non-PoE device) or the use of a PoE Class 1 (PoE device).
- Do not connect or disconnect this device from the I/O module or 15-pin USB adapter cable when the I/O module or adapter cable is connected to a PC.
- Route cables and wires away from high-current wiring or high-voltage power sources to reduce the risk of damage or malfunction from the following causes: over-voltage, line noise, electrostatic discharge (ESD), power surges, or other irregularities in the power supply.
- Changes or modifications not expressly approved by the party responsible for regulatory compliance could void the user's authority to operate the equipment.
- Ensure that the cable bend radius begins at least six inches from the connector. Cable shielding can be degraded or cables can be damaged or wear out faster if a service loop or bend radius is tighter than 10X the cable diameter.
- This device should be used in accordance with the instructions in this manual.
- All specifications are for reference purposes only and can change without notice.
- This product is intended for industrial use in automated manufacturing or similar applications.

- The safety of any system incorporating this product is the responsibility of the assembler of the system.
- This product does not contain user-serviceable parts. Do not make electrical or mechanical modifications to product components. Unauthorized modifications can void your warranty.

Symbols

The following symbols indicate safety precautions and supplemental information:



WARNING: This symbol indicates a hazard that could cause death, serious personal injury or electrical shock.



CAUTION: This symbol indicates a hazard that could result in property damage.



Note: This symbol indicates additional information about a subject.



Tip: This symbol indicates suggestions and shortcuts that might not otherwise be apparent.

Product Overview

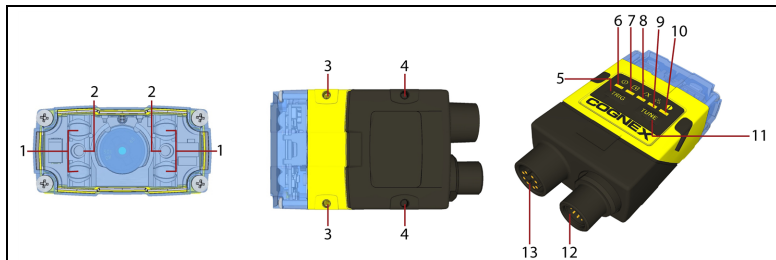

Item	Description
1	Illumination LEDs
2	LED aimers
3-4*	Mounting holes (M3 x 3.5mm)
5	Trigger button
6	Power indicator
7	Train status indicator
8	Good/bad read indicator
9	Network status indicator
10	Error indicator
11	Tune button







12	Power, I/O and RS-232 connector
13	Ethernet connector





i Note: *Use only one set of mounting holes (either 3 OR 4) for mounting.

i Note: The five status LEDs together also function as a peak meter using an orange light.

DataMan 260 Accessories

LENS OPTIONS, COVERS, ILLUMINATIONS AND FILTERS

Accessory Name	Accessory Number	Accessory Image
6.2 mm lens kit	DM150-LENS-62	
IR 6.2 mm lens kit, 3 -position with IR LED	DMA-KIT-IR-62	
IR 16 mm lens kit	DMA-KIT-IR-16	
16 mm lens with extended optics mount (requires the use of an extended front cover and high-powered red LED)	DM260-LENS-16	
UV Light Kit for 6.2 mm lens (365nm)	DMA-KIT-UV365-62	
Liquid Lens Module (LLM) to be used with 6.2 mm lens or 16 mm lens	DMA-LLM-150-260	

ImageMax kit	DM260-KIT-16LL	
Clear lens cover*	DM150-CVR-CLR	
Clear lens cover, ESD safe*	DM150-CVR-ESD	
Polarized front cover*	DM260-LENS-62CVR- F**	
Extended lens cover, un-polarized** Extended lens cover, half-polarized ** Extended lens cover, fully polarized**	DM260-LENS-16CVR*** DM260-LENS-16CVR- P*** DM260-LENS-16CVR- F***	
C-mount adaptor, IP40	DM260-CMNT-00	
C-mount adaptor, IP65	DM260-CMNT-CVR	
Blue bandpass filter	DM150-BP470	
Red bandpass filter	DM150-BP635	
Red LED illumination* White LED illumination* Blue LED illumination*	DM150-LED-RED DM150-LED-WHT DM150-LED-BLU	
High Powered red LED illumination**	DM260-LED-RED-HP	









Note: *Use with a 6.2 mm lens only!

**Use with a 16 mm lens only!

***ESD safe

CABLES AND OTHER

Accessory Name	Accessory Number	Accessory Image
Connection cable 24V, I/O, RS-232	CCBL-05-01 CCB-M12x12Fy-xx (y=S: straight / y=A: angled *, xx specifies length)	
Connection cable RS-232	CCB-M12xDB9Y-05	
Adapter cable, M12x12 to M8x4/M8x5, 0.5 m	DM260-ADAP-M12M8	
X-Coded to RJ45 Ethernet Cable	CCB-84901-2001-xx, where xx can be 02, 05, 10, 15 or 30, indicating length in meters	
Adapter cable, ETH, M12, X-CODED/A-CODED, 0.5 m	CCB-M12x8MS-XCAC	
Universal Mounting Bracket	DM100-UBRK-000	
Pivot Mounting Bracket	DM100-PIVOTM-00	

Dimensional Drawings

The size of the DataMan 260 in the angled configuration is shown in the following figures:

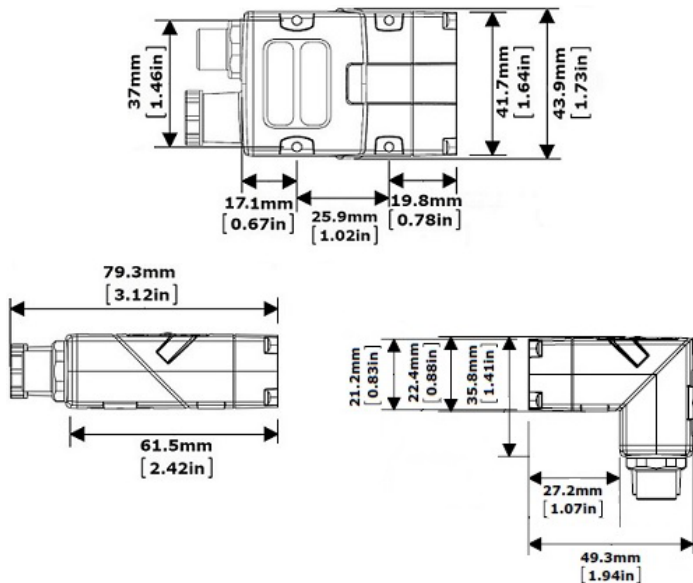

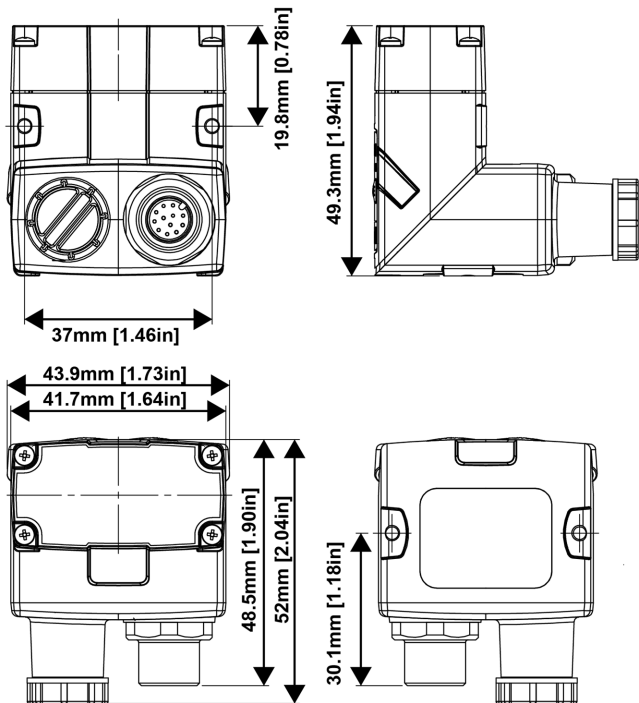

The size of the DataMan 260 with the extended lens cover configuration is shown in the following figures:

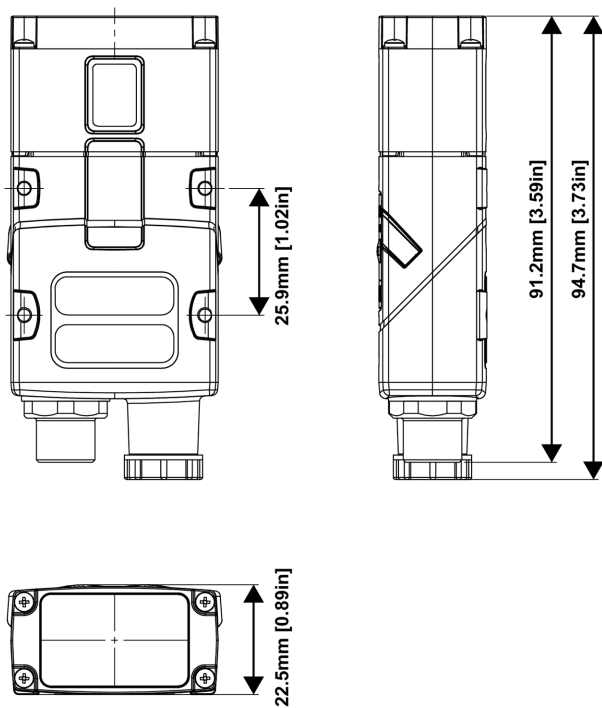

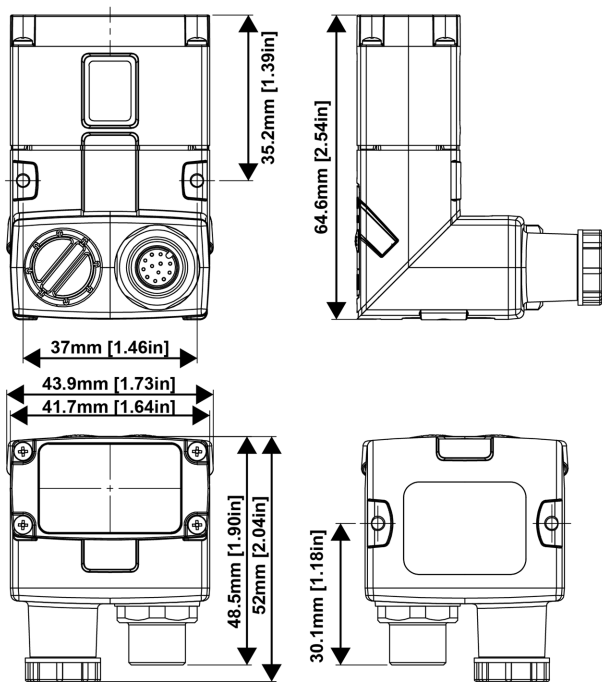

The size of the DataMan 260 with the side read mirror configuration is shown in the following figure:

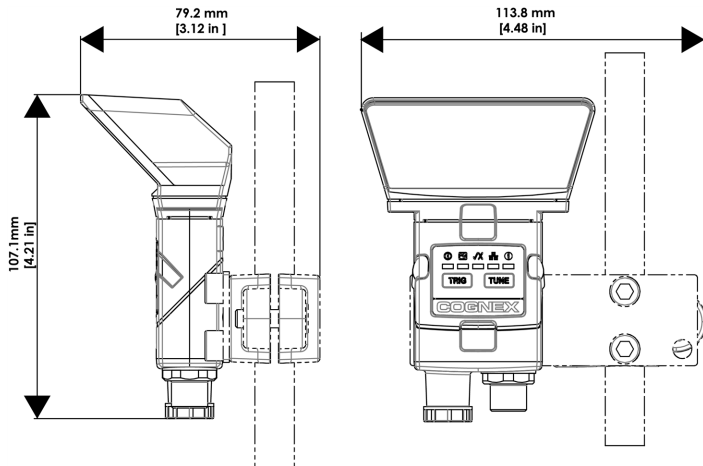

Field of View and Reading Distances

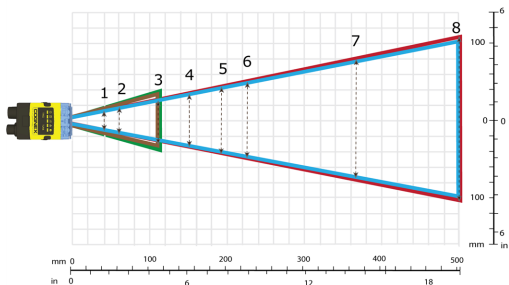

Horizontal Field of View values

Device	1	2	3	4
DM260	Short Range: 34 mm [1.3 in]	Short Range: 50 mm [1.9 in]	Short Range: 77 mm [3.0 in]	Long Range: 115 mm [4.5 in]
DM262	Short Range: 37 mm [1.45 in]	Short Range: 56 mm [2.2 in]	Short Range: 87 mm [3.4 in]	Long Range: 123 mm [4.8 in]

	5	6	7	8
DM260	Long Range: 144 mm [5.6 in]	Long Range: 170 mm [6.7 in]	Long Range: 279 mm [10.9 in]	Long Range: 370 mm [14.5 in]
DM262	Long Range: 153 mm [6.0 in]	Long Range: 181 mm [7.1 in]	Long Range: 297 mm [11.7 in]	Long Range: 394 mm [15.5 in]

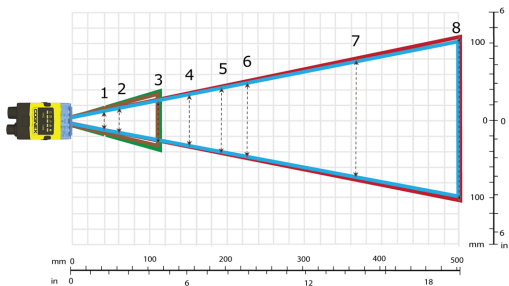

Vertical Field of View values

Device	1	2	3	4

DM260	Short Range: 22 mm [0.86 in]	Short Range: 32 mm [1.25 in]	Short Range: 49 mm [1.9 in]	Long Range: 73 mm [2.8 in]
DM262	Short Range: 28 mm [1.1 in]	Short Range: 42 mm [1.65 in]	Short Range: 65 mm [2.5 in]	Long Range: 92 mm [3.6 in]
	5	6	7	8
DM260	Long Range: 92 mm [3.6 in]	Long Range: 108 mm [4.25 in]	Long Range: 178 mm [7.0 in]	Long Range: 236 mm [9.2 in]
DM262	Long Range: 115 mm [4.5 in]	Long Range: 135 mm [5.3 in]	Long Range: 223 mm [8.7 in]	Long Range: 295 mm [11.6 in]

Reading Distance for 1D and 2D Codes with 6.2 mm Lens

Device	Distances in mm/ 2D min. code 6.2 mm lens Long Range		Distances in mm/ 1D min. code 6.2 mm lens Long Range	
	mm	MIL	mm	MIL
DM260	150	12 MIL	150	6 MIL
	190	15 MIL	190	10 MIL
	225	18 MIL	225	10 MIL
	375	30 MIL	375	15 MIL
	500	35 MIL	500	20 MIL
	1000	80 MIL	1000	35 MIL
DM262	150	10 MIL	150	5 MIL
	190	12 MIL	190	6 MIL
	225	15 MIL	225	6 MIL
	375	20 MIL	375	10 MIL
	500	25 MIL	500	15 MIL
	1000	50 MIL	1000	30 MIL

Device	Distances in mm/ 2D min. code 6.2 mm lens Short Range		Distances in mm/ 1D min. code 6.2 mm lens Short Range	
	DM260	40	4 MIL	40
65		5 MIL	65	3 MIL
105		10 MIL	105	6 MIL
DM262	40	3 MIL	40	2 MIL
	65	4 MIL	65	2 MIL
	105	7 MIL	105	5 MIL

Reading Distance for 1D and 2D Codes with 16 mm Lens

Device	Distances in mm/ 2D min. code 16 mm lens		Distances in mm/ 1D min. code 16 mm lens	
	DM260	80	3 MIL	80
150		5 MIL	150	3 MIL
190		6 MIL	190	4 MIL
225		7 MIL	225	4 MIL
375		12 MIL	375	5 MIL
500		15 MIL	500	10 MIL
1000		25 MIL	1000	15 MIL
DM262	80	2 MIL	80	2 MIL
	150	3 MIL	150	2 MIL
	190	4 MIL	190	2 MIL
	225	4 MIL	225	3 MIL
	375	7 MIL	375	4 MIL
	500	10 MIL	500	6 MIL
	1000	20 MIL	1000	15 MIL

DataMan 260 Readers with Side Read Mirror

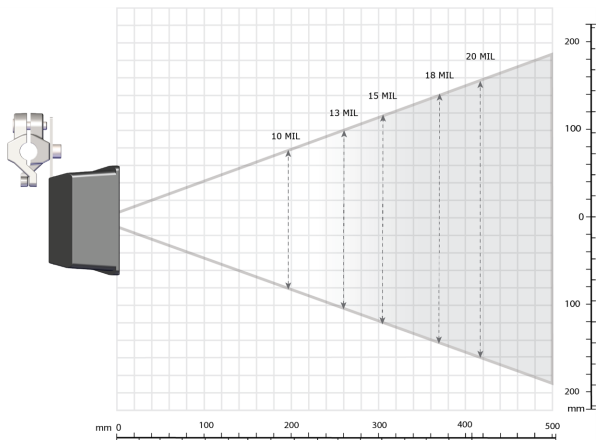

The following table shows the Field of View (FoV) widths of DM260 with 6.2 mm lens focused to 190 mm at various distances.

Device	1D min. code	Distance in mm	Width in mm
DM260	10 MIL	196	158
	13 MIL	261	205
	15 MIL	305	237
	18 MIL	370	285
	20 MIL	414	316

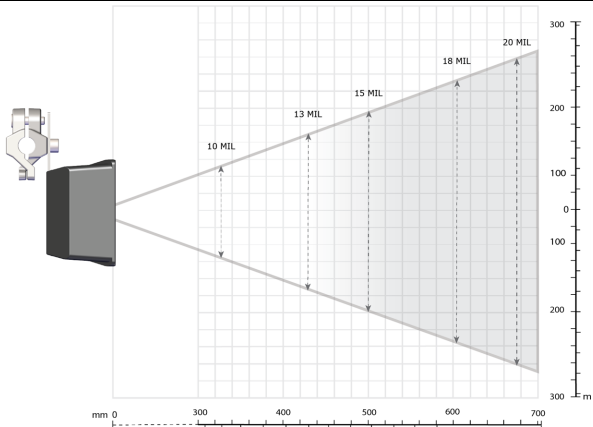

The following table shows the Field of View (FoV) widths of DM262 with 6.2 mm lens focused to 190 mm at various distances.

Device	1D min. code	Distance in mm	Width in mm
DM262	10 MIL	327	269
	13 MIL	431	350
	15 MIL	501	404
	18 MIL	605	485
	20 MIL	675	539

Connecting the Reader

Perform the following steps:

1. Mount the reader.
2. Connect the Ethernet cable (CCB-84901-2001-05) either to a computer or a switch.
3. Connect the breakout cable (CCBL-05-01).

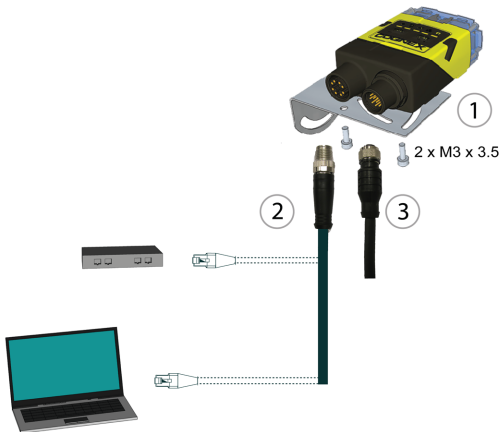

For information on the pinout and wire colors, see section *Connections, Optics and Lighting* in the *DataMan 260 Reference Manual*.

Mounting

Mounting the DataMan 260 at a slight angle (15°) can reduce reflections and improve reader performance.

Use the set of mounting holes on the rear part to mount the DataMan reader.

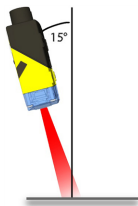

Connect the Ethernet Cable

1. Connect the Ethernet cable's M12 connector to the reader ENET connector.
2. Connect the Ethernet cable's RJ-45 connector to a switch/router or PC, as applicable.

Connect the Breakout Cable



Note: You can clip unused wires short or use a tie made of non-conductive material to tie them back.

1. Verify that the 24 V DC power supply is unplugged and not receiving power.

2. Attach the Breakout cable's +24VDC and GROUND to the corresponding terminals on the power supply.



CAUTION: Never connect voltages other than 24 V DC. Always observe the polarity shown.

3. Attach the Breakout cable's M12 connector to the DataMan 260 reader's 24VDC connector.
4. Restore power to the 24 V DC power supply and turn it on if necessary.

Installation

Installation procedures are detailed in the *DataMan 260 Reference Manual*, which is installed with the DataMan Setup Tool. The DataMan Setup Tool is available from the DataMan support site: <http://www.cognex.com/support/dataman>.

To access documentation, open the Windows Start menu, select *All Programs > Cognex > DataMan Software vx.x.x > Documentation*.

Note:

- Cables are sold separately.
- If a standard component is missing or damaged, immediately contact your Cognex Authorized Service Provider (ASP) or Cognex Technical Support.



CAUTION: All cable connectors are "keyed" to fit the connectors on the DataMan system; do not force the connectors or damage may occur.

1. After installing the software, connect the DataMan 260 Series reader to your PC.
2. Launch the DataMan Setup Tool and click **Refresh**.
3. Select your DataMan 260 reader from the list and click **Connect**.

DataMan 260 Specifications

Specification	DataMan 260 Series Reader
Weight	142 g
Operating Temperature	0°C — +40°C (+32°F — +104°F)
Storage Temperature	-10°C — +60°C (+14°F — +140°F)
Maximum Humidity	<95% (non-condensing)
Environmental	IP65
Shock and Vibration	IEC 60068-2-27: 1000 shocks, semi-sinusoidal, 11g, 10ms IEC 60068-2-6: vibration test in each of the three main axis for 2 hours @ 10 Gs (10 to 500 Hz at 100m/s ² / 15mm)
LED Safety	IEC 62471: Exempt risk group, no further labeling is required.
RS-232	RxD, TxD according to TIA/EIA-232-F
Codes	1-D barcodes: Codabar, Code 39, Code 128, and Code 93, Code 25, Interleaved 2 of 5, Pharma, GS1 DataBar, Postal, Code UPC/EAN/JAN, MSI 2-D barcodes: Data Matrix™ (IDMax and IDQuick: ECC 0, 50, 80, 100, 140, and 200) QR Code and microQR Code, RSS/CS, PDF 417, MicroPDF 417, AztecCode, DotCode, MaxiCode

Discrete I/O operating Limits	HS Output 0, 1, 2, 3	I_{MAX}	@ 24 VDC	50 mA
		R_{MAX}	@ 12 VDC	150 Ω
			@ 24 VDC	470 Ω
	Input 0 (Trigger)	V_{IH}	± 15 — ± 25 V	
	Input 1	V_{IL}	0 — ± 5 V	
		I_{TYP}	@ 12 VDC	2.0 mA
			@ 24 VDC	4.2 mA
Power Supply Requirements	<ul style="list-style-type: none"> PoE powered: Class 1 PoE supply, maximum 3.84 W, or External power supply (no PoE): +24 VDC +/- 10% (1 A maximum, 5 W average) Supplied by LPS or NEC class 2 only			
Power Consumption	<3.84 W (PoE Class 1) <5 W (average, externally powered at +24 V)			

DataMan 260 Series Imager Specifications

Specification	DataMan 260 Imager	DataMan 262 Imager
Image Sensor	1/3 inch CMOS	1/3 inch CMOS
Image Sensor Properties	4.51 mm x 2.88 mm (W x H), 6.0 μ m square pixels	4.8 mm x 3.6 mm (W x H), 3.75 μ m square pixels
Image Resolution (pixels)	752 x 480	1280 x 960

Specification	DataMan 260 Imager	DataMan 262 Imager
Lens Type	S-mount 6.2 mm F:5 (with optional liquid lens) with IR blocking filter S-mount 16 mm F:7 (with optional liquid lens) with IR blocking filter	

LED Wavelengths

The following table shows LED types and the related wavelengths:

LED	λ [nm]
RED	617
RED HPIL	617
BLUE	470
WHITE	6500K (Color Temperature)
IR	850
IR HPIL	850
UV	365

Regulations/Conformity

The DataMan 260 has Regulatory Models 1AA5, 1ABD, 1AA0, 1ABF and meets or exceeds the requirements of all applicable standards organizations for safe operation. However, as with any electrical equipment, the best way to ensure safe operation is to operate them according to the agency guidelines that follow. Please read these guidelines carefully before using your device.



Note: For the most current CE declaration and regulatory conformity information, see the Cognex support site: cognex.com/support.

Safety and Regulatory	
Manufacturer	Cognex Corporation One Vision Drive Natick, MA 01760 USA
USA	FCC 47 CFR Part 15 Subpart B, Class A This device complies with Part 15 of the FCC Rules. Operation is subject to the following two conditions: (1) this device may not cause harmful interference; and (2) this device must accept any interference received, including interference that may cause undesired operation. This equipment generates, uses, and can radiate radio frequency energy and, if not installed and used in accordance with the instruction manual, may cause harmful interference to radio communications. Operation of this equipment in a residential area is likely to cause harmful interference in which case the user will be required to correct the interference at their own expense.
Canada	ICES-003, Class A This Class A digital apparatus complies with Canadian ICES-003. Cet appareil numérique de la classe A est conforme à la norme NMB-003 du Canada.

Safety and Regulatory	
Europe	EN55022 (CISPR 22) Class A EN55024 EN60950 This is a class A product. In a domestic environment this product may cause radio interference in which case the user may be required to take immediate measures. This equipment complies with the essential requirements of the EU Directive 2014/30/EU. Declarations are available from your local representative. The CE mark on the product indicates that the system has been tested to and conforms with the provisions noted within the 2014/30/EU Electromagnetic Compatibility Directive. For further information please contact: Cognex Corporation, One Vision Drive Natick, MA 01760 USA. Cognex Corporation shall not be liable for use of our product with equipment (i.e., power supplies, personal computers, etc.) that is not CE marked.
Australia	Radiocommunications (Electromagnetic Compatibility) Standard: 2017 (EN 55032:2012) 
Korea	KN22, KN24 A급 기기 (업무용 방송통신기자재): 이 기기는 업무용(A급) 전자파 적합기기로서 판매자 또는 사용자는 이 점을 주의하시기 바라며, 가정외의 지역에서 사용하는 것을 목적으로 합니다. Certificate number: MSIP-REM-CGX-DM260 MSIP-REM-CGX-DM262X MSIP-REM-CGX-DM260PoE
Japan	VCCI V-3/2015.04 Class A <div style="border: 1px solid black; padding: 10px; text-align: center;"> <p>この装置は、クラスA情報技術装置です。この装置を家庭環境で使用すると電波妨害を引き起こすことがあります。この場合には使用者が適切な対策を講ずるよう要求されることがあります。</p> <p>VCCI-A</p> </div>
TÜV	Regulatory Model 1AA3 Regulatory Model 1ABE TÜV SÜD SCC/NRTL OSHA Scheme for UL/CAN 61010-1.. CB report available upon request. .TÜV SÜD, IEC/EN 61010-1.

For European Community Users

Cognex complies with Directive 2012/19/EU OF THE EUROPEAN PARLIAMENT AND OF THE COUNCIL of 4 July 2012 on waste electrical and electronic equipment (WEEE).

This product has required the extraction and use of natural resources for its production. It may contain hazardous substances that could impact health and the environment, if not properly disposed.

In order to avoid the dissemination of those substances in our environment and to diminish the pressure on the natural resources, we encourage you to use the appropriate take-back systems for product disposal. Those systems will reuse or recycle most of the materials of the product you are disposing in a sound way.



The crossed out wheeled bin symbol informs you that the product should not be disposed of along with municipal waste and invites you to use the appropriate separate take-back systems for product disposal.

If you need more information on the collection, reuse, and recycling systems, please contact your local or regional waste administration.

You may also contact your supplier for more information on the environmental performance of this product.

中国大陆RoHS (Information for China RoHS Compliance)

根据中国大陆《电子信息产品污染控制管理办法》(也称为中国大陆RoHS),以下部份列出了本产品中可能包含的有毒有害物质或元素的名称和含量。



Table of toxic and hazardous substances/elements and their content, as required by China's management methods for controlling pollution by electronic information products.

	Hazardous Substances 有害物质					
Part Name 部件名称	Lead (Pb) 铅	Mercury (Hg) 汞	Cadmium (Cd) 镉	Hexavalent Chromium (Cr (VI)) 六价铬	Polybrominated biphenyls (PBB) 多溴联苯	Polybrominated diphenyl ethers (PBDE) 多溴二苯醚
Regulatory Models 1AA5, 1ABD, 1AA0, 1ABF	X	O	O	O	O	O
<p>This table is prepared in accordance with the provisions of SJ/T 11364. 这个标签是根据SJ/T 11364的规定准备的。</p> <p>O: Indicates that said hazardous substance contained in all of the homogeneous materials for this part is below the limit requirement of GB / T26572 - 2011. 表示本部件所有均质材料中含有的有害物质低于GB / T26572 - 2011的限量要求。</p> <p>X: Indicates that said hazardous substance contained in at least one of the homogeneous materials used for this part is above the limit requirement of GB / T26572 - 2011. 表示用于本部件的至少一种均质材料中所含的危害物质超过GB / T26572 - 2011的限制要求。</p>						

Copyright © 2021
Cognex Corporation. All Rights Reserved.