

# COGNEX

## DataMan<sup>®</sup> 8700 Quick Reference Guide



2023 July 03

Revision: 23.2.1.3

# Precautions

To reduce the risk of injury or equipment damage, observe the following precautions when you install the Cognex product:

- This product is intended for industrial use in automated manufacturing or similar applications.
- The safety of any system incorporating this product is the responsibility of the assembler of the system.
- This product does not contain user-serviceable parts. Do not make electrical or mechanical modifications to product components. Unauthorized modifications can void your warranty.
- Route cables and wires away from high-current wiring or high-voltage power sources to reduce the risk of damage or malfunction from the following causes: over-voltage, line noise, electrostatic discharge (ESD), power surges, or other irregularities in the power supply.
- Changes or modifications not expressly approved by the party responsible for regulatory compliance could void the user's authority to operate the equipment.
- Ensure that the cable bend radius begins at least six inches from the connector. Cable shielding can be degraded or cables can be damaged or wear out faster if a service loop or bend radius is tighter than 10X the cable diameter.
- This device should be used in accordance with the instructions in this manual.
- All specifications are for reference purposes only and can change without notice.

# Symbols

The following symbols indicate safety precautions and supplemental information:



**WARNING:** This symbol indicates a hazard that could cause death, serious personal injury or electrical shock.

---



**CAUTION:** This symbol indicates a hazard that could result in property damage.

---



**Note:** This symbol indicates additional information about a subject.

---



**Tip:** This symbol indicates suggestions and shortcuts that might not otherwise be apparent.

---

# Product Overview

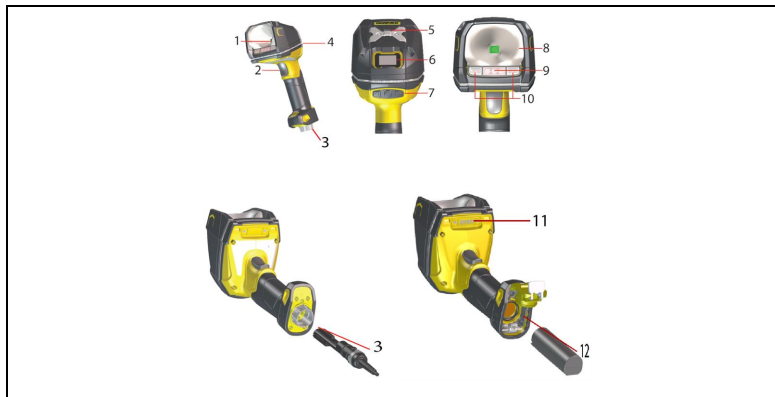

Number	DataMan 8700 DX Reader
1	LED aimer
2	Trigger (press and hold to read)
3	Cable insertion point (corded readers only)
4	360° ring light indicator
5	Lanyard hook



Number	DataMan 8700 DX Reader
6	OLED display
7	OLED input and configuration buttons
8	Diffused light
9	Polarized light
10	Direct light
11	Charging pins (wireless readers only)
12	Battery insertion (wireless readers only)

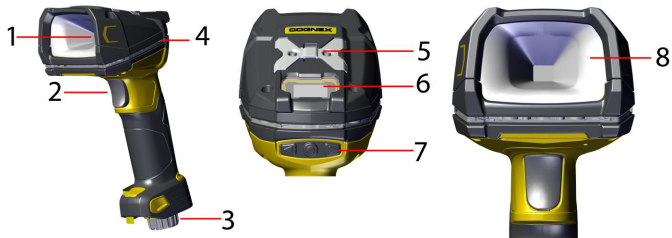

Number	DataMan 8700 DQ Reader
1	LED aimer
2	Trigger (press and hold to read)
3	Cable insertion point (corded readers only)
4	360° ring light indicator
5	Lanyard hook
6	OLED display
7	OLED input and configuration buttons
8	Diffused light



Number	DataMan 8700 LX Reader
1	LED aimer
2	Trigger (press and hold to read)
3	Cable insertion point (corded readers only)
4	360° ring light indicator
5	Lanyard hook
6	OLED display
7	OLED input and configuration buttons
8	Direct light



Number	DataMan 8700 HD Reader
1	LED aimer
2	Trigger (press and hold to read)
3	Cable insertion point (corded readers only)
4	360° ring light indicator
5	Lanyard hook
6	OLED display
7	OLED input and configuration buttons
8	Diffused light

# OLED Display Layout

The OLED display is user interface where you can communicate with the DataMan 8700.

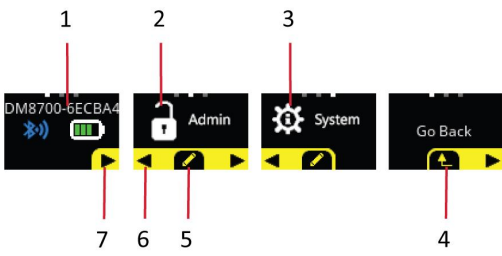

The diagram illustrates the OLED display layout with four screens and their navigation controls. The screens are labeled 1 through 4, and the navigation controls are labeled 5 through 7. Screen 1 (Main Screen) shows the device name 'DM8700-6ECBA4', Bluetooth and battery icons, and a right arrow. Screen 2 (Admin Screen) shows a lock icon, the word 'Admin', and left and right arrows. Screen 3 (System Screen) shows a gear icon, the word 'System', and left and right arrows. Screen 4 (Go Back) shows the text 'Go Back' and a left arrow. Navigation controls 5, 6, and 7 are shown as pencil, checkmark, and toggle icons respectively, positioned below the arrows on screens 2 and 3.

Number	Screen or Icon	Description
1	Main Screen	First screen after boot up is complete. The main screen contains information about the name of the reader, the Bluetooth connection and the battery status of the reader. <sup>1</sup>
2	Admin Screen	Enter the menu on the admin screen, where you can set passwords and other permissions.
3	System Screen	Enter the system menu, where you can configure settings
4	Return arrow	Return one level up in the menu
5	Action button	Displays a pencil, a check mark, or a toggle icon to select, acknowledge or change a setting.
6	Left arrow	Move to previous screen.
7	Right arrow	Move to next screen

<sup>1</sup> The Bluetooth connection and the battery status of the reader is only displayed on wireless readers.

# Base Station Overview

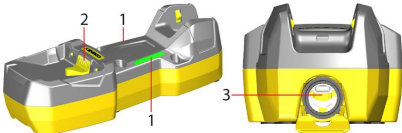
DMB8700 Intelligent Base Station	
	
1	<p>Base station status indicators</p> <p>Reader on base station:</p> <ul style="list-style-type: none"><li>• RED = charging, or indicating contact status with the cradle</li></ul> <p>Reader off base station:</p> <ul style="list-style-type: none"><li>• BLUE = connected via BT</li><li>• OFF = no connection</li></ul>
2	<p>Connection point with the reader:</p> <ul style="list-style-type: none"><li>• pairing reader and base station</li><li>• non-wireless communication</li><li>• charging</li></ul>
3	<p>Cable plug</p>

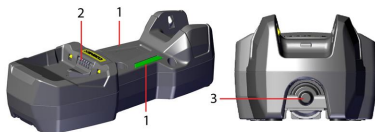

### DMB8700 Charging Base Station





1	Base station status indicators Reader on base station: <ul style="list-style-type: none"><li>• RED = charging</li></ul> Reader off base station: <ul style="list-style-type: none"><li>• OFF = no connection</li></ul>
2	Connection point with the reader: <ul style="list-style-type: none"><li>• Charging</li></ul>
3	Non-removable cable

# DataMan 8700 Accessories







## Base Stations

Accessory Name	Accessory Number	Accessory Image
DM8700 Base Station with RS-232 Slide-in	DMB-8700-RS	
DM8700 Base Station with USB Slide-in	DMB-8700-USB	
DM8700 Base Station with Ethernet Slide-in	DMB-8700-E	
DM8700 Base Station Charge-Only	DMB-8700-CHARGE	

## Power Supplies









Accessory Name	Accessory Number	Accessory Image
Power Supply for USB and RS-232 communication on the corded reader or wireless base station reader and base station	DM8700-PWR-00	
5000 mAh Battery for the wireless reader	DMA-BATTERY-5000-1	
4-bay Battery Charger for 5000 mAh Batteries	DMA-MBC-5000	

## Cables

Accessory Name	Product ID	Illustration
Flying lead cable for the C-base	DMB8700-CHARGE-FL	
RS-232 coiled cable, 2.5 m with Dsub-9 connector, power over pin 9	DMC-HH-RS232P-02C	
RS-232 coiled cable, 2.5 m with Dsub-9 connector	DMC-HH-RS232-02C	
RS-232 coiled cable, 4 m with Dsub-9 connector	DMC-HH-RS232-05C	
RS-232 Firmware update cable, RS-232 to USB converter included with RS-232 kits	DMC-HH-RS232-USB	
USB straight cable, 2.5 m with USB type-A connector	DMC-HH-USBA-02	
USB coiled cable, 2.5 m with USB type-A connector	DMC-HH-USBA-02C	
USB straight cable, 2.5m with USB type-C connector	DMC-HH-USBC-02	
USB coiled cable, 2.5m with USB type-C connector	DMC-HH-USBC-02C	
Ethernet coiled cable, 5m with RJ45 connector	DMC-HH-ENET-05C	
Ethernet straight cable, 2.5m with RJ45 connector	DMC-HH-ENET-02	
Ethernet straight cable, 5m with RJ45 connector	DMC-HH-ENET-05	
Ethernet straight cable, 30m with RJ45 connector	DMC-HH-ENET-30	
Ethernet coiled cable, 5 m with M12 X-coded connector	DMC-HH-ENETM12-05C	

**Note:** Collimated cable length for Ethernet does not have to exceed 50m.

## Miscellaneous Accessories

Accessory Name	Accessory Number	Accessory Image
DM8700 slide-in communication USB conversion kit	DM8700-USB-KIT	
DM8700 slide-in communication Ethernet conversion kit	DM8700-ENET-KIT	
DM8700 slide-in communication RS-232 conversion kit	DM8700-RS-KIT	
4 Port 24 V DC Industrial PoE Supply	CPS-24V-POE4	
PoE injector for one device	CPS-AC-POE1A-xx <sup>1</sup>	
Wall Mount Bracket	DMA-WALL-8700	
Presentation Stand, can be used with wall mount bracket (DMA-WALL-8700)	DM-STAND-00	
Holster	DMA-HOLSTER-8700	

<sup>1</sup> xx can be US, EN, UK, or JP.

# Field of View and Reading Distances for 8700DX

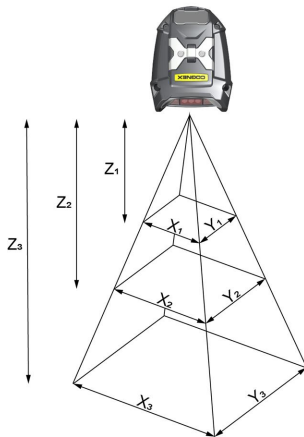

DM8700 DX Field of View Values		
Working Distance	Horizontal Values	Vertical Values
$Z_1 = 40 \text{ mm (1.5 in)}$	$X_1 = 63 \text{ mm (2.5 in)}$	$Y_1 = 47 \text{ mm (1.8 in)}$
$Z_2 = 140 \text{ mm (5.5 in)}$	$X_2 = 126 \text{ mm (5 in)}$	$Y_2 = 95 \text{ mm (3.7 in)}$
$Z_3 = 300 \text{ mm (11.8 in)}$	$X_3 = 228 \text{ mm (11.3 in)}$	$Y_3 = 171 \text{ mm (6.7 in)}$



**Note:** All values beginning with 0 denote the minimum distance where the Field of View is able to see the entire code.

<b>DM8700 DX Depth of Field Values</b>			
<b>Distances in mm / 1D min code</b>		<b>Distances in mm / 2D min code</b>	
18-58	3 MIL	10-71	5 MIL
10-175	10 MIL	10-155	10 MIL
0-650	50 MIL	0-650	50 MIL
0-1000	100 MIL	0-1000	100 MIL

# Field of View and Reading Distance for DataMan 8700 DQ

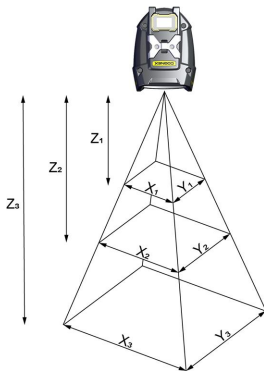

DM8700 DQ Field of View Values		
Working Distance	Horizontal Values	Vertical Values
$Z_1 = 48 \text{ mm (1.9 in)}$	$X_1 = 79 \text{ mm (3.1 in)}$	$Y_1 = 60 \text{ mm (2.4 in)}$
$Z_2 = 140 \text{ mm (5.5 in)}$	$X_2 = 148 \text{ mm (5.8 in)}$	$Y_2 = 111 \text{ mm (4.4 in)}$
$Z_3 = 300 \text{ mm (11.8 in)}$	$X_3 = 275 \text{ mm (10.8 in)}$	$Y_3 = 206 \text{ mm (8.1 in)}$

**DM8700 DQ Depth of Field Values**

<b>Distances in mm / 1D min code</b>		<b>Distances in mm / 2D min code</b>	
25-70	3 MIL	10-60	5 MIL
55-300	30 MIL		

# Field of View and Reading Distances for DataMan 8700 LX

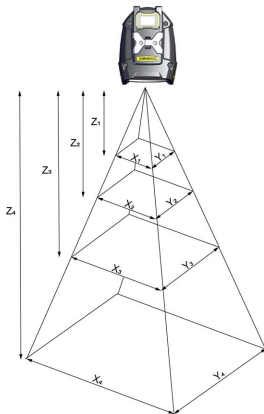

**DM8700 LX Field of View Values**

Working Distance	Horizontal Values	Vertical Values
$Z_1 = 30 \text{ mm (1.2 in)}$	$X_1 = 11 \text{ mm (0.4 in)}$	$Y_1 = 15 \text{ mm (0.6 in)}$
$Z_2 = 180 \text{ mm (7.1 in)}$	$X_2 = 116 \text{ mm (4.5 in)}$	$Y_2 = 87 \text{ mm (3.4 in)}$

<b>DM8700 LX Field of View Values</b>		
<b>Working Distance</b>	<b>Horizontal Values</b>	<b>Vertical Values</b>
Z <sub>3</sub> = 300 mm (11.8 in)	X <sub>3</sub> = 193 mm (7.6 in)	Y <sub>3</sub> = 149 mm (5.9 in)
Z <sub>4</sub> = 650 mm (25.6 in)	X <sub>4</sub> = 418 mm (16.5 in)	Y <sub>4</sub> = 320 mm (12.6 in)

<b>DM8700 LX Depth of Field Values</b>			
<b>Distances in mm / 1D min code</b>		<b>Distances in mm / 2D min code</b>	
70-180	4 MIL	30-270	10 MIL
45-300	6 MIL		
40-650	20 MIL		

# Field of View and Reading Distances for DataMan 8700 HD

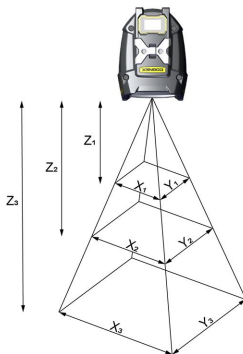

DM8700 HD Field of View Values		
Working Distance	Horizontal Values	Vertical Values
$Z_1 = 20 \text{ mm (0.8 in)}$	$X_1 = 25 \text{ mm (0.9 in)}$	$Y_1 = 20 \text{ mm (0.8 in)}$
$Z_2 = 45 \text{ mm (1.8 in)}$	$X_2 = 35 \text{ mm (1.4 in)}$	$Y_2 = 25 \text{ mm (0.9 in)}$
$Z_3 = 90 \text{ mm (3.5 in)}$	$X_3 = 55 \text{ mm (2.1 in)}$	$Y_3 = 40 \text{ mm (1.6 in)}$

**DM8700 HD Depth of Field Values**

<b>Distances in mm / 1D min code</b>		<b>Distances in mm / 2D min code</b>	
27-50	3 MIL	25-40	2 MIL
85-100	20 MIL	20-50	5 MIL

# Connecting the Reader

Wireless reader Battery Insertion:

1. Pull out metal tab to open the end cap.
2. Insert the battery.
3. Close the end cap by pressing the metal tab.



Cable connection to the base station:

1. Connect the USB or RS-232 cable with external power or the Power over Ethernet (PoE) cable to the base station.

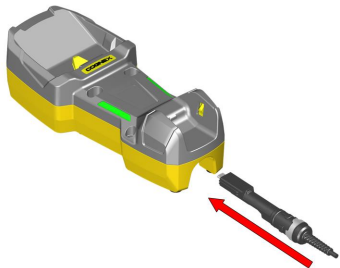

2. Connect the other end of the cable to the computer or to the hub.

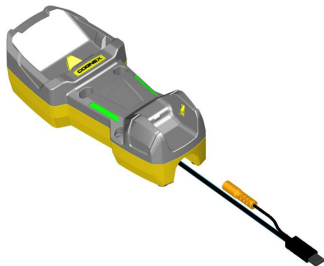

3. If using PoE cable, skip this step. For cables with RS-232 or USB-A connector, connect the 5.5 V power supply.



4.

**Note:**

When you connect the reader through USB, always use a power supply. When using a DM8700 DX with a USB cable (DMC-HH-USBA-02 or DMC-HH-USBC-02), make sure to connect the USB connector to a USB hub that stays enabled even if the PC or notebook goes to sleep.



When using other models including base station, connecting to a USB hub that is always enabled is not obligatory, but strongly recommended.



**Note:** Disconnect the DataMan 8700 from power before inserting the communication modules.

#### Corded reader Cable insertion:

1. Use a small screwdriver or a pencil to press in the gray tab by the cable insertion.



2. Turn the cable insertion mechanism to the open position.



3. Insert the cable.
4. Lock the cable by turning the cable insertion mechanism to the opposite direction.



# Base Station Mounting Options

You can mount the base station in the following ways:

- Horizontal mounting:
  - Into wood: use a 10 x 2 inch rounded head screw.
  - Into metal: use a 10 x 1 5/8 inch socket head cap screw.
  - Into metal: use an M5 x 40 mm socket head cap screw.
- Vertical mounting:
  - Into wood: use a 10 x 2 1/4 inch rounded head screw.
  - Into metal: use a 10 x 1 7/8 inch socket head cap screw.
  - Into metal: use an M5 x 40 mm socket head cap screw.



**Note:** If you mount the base station into drywall, use additional drywall anchors.

Recommended torque for mounting the base station:

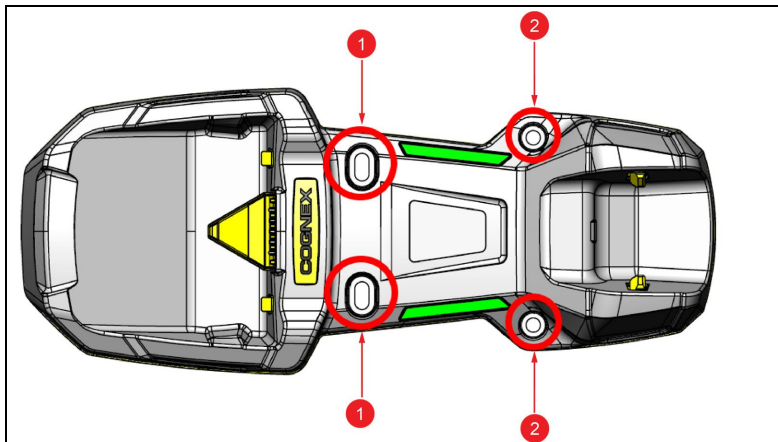

Number	Description	Maximum Recommended Torque
1	Top-side mounting holes	0.5 Nm
2	Top-side mounting holes	0.2 Nm

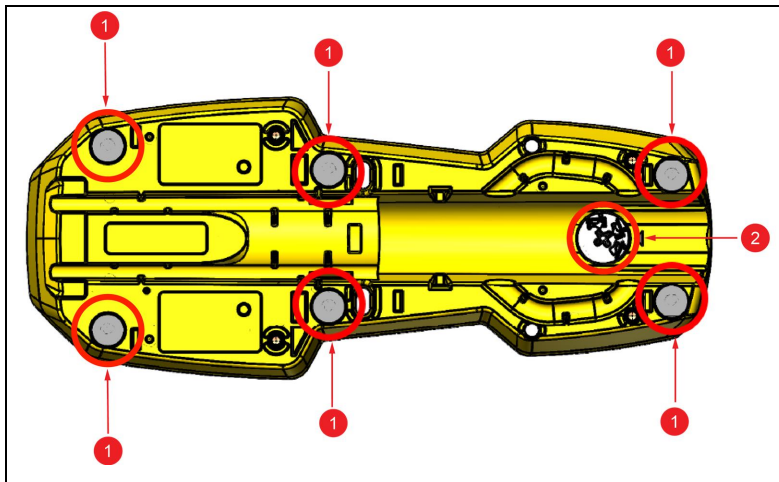

Number	Description	Maximum Recommended Torque
1	Bottom-side threaded inserts	0.5 Nm
2	Grip strength tuner	-

# Installation

Installation procedures are detailed in the *DataMan DM8700 Reference Manual*, which is installed with the DataMan Setup Tool. The DataMan Setup Tool is available from the DataMan support site: <http://www.cognex.com/support/dataman>.

To access documentation, open the Windows Start menu, select *All Programs > Cognex > DataMan Software vx.x.x > Documentation*.

---

**Note:**

- Cables are sold separately.
- If a standard component is missing or damaged, immediately contact your Cognex Authorized Service Provider (ASP) or Cognex Technical Support.



**CAUTION:** All cable connectors are "keyed" to fit the connectors on the DataMan system; do not force the connectors or damage may occur.

---

1. After installing the software, connect the DataMan 8700 to your PC.
2. Launch the DataMan Setup Tool and click **Refresh**.
3. Select your DataMan 8700 Series reader from the list and click **Connect**.

# DataMan 8700 Specifications

Specification	DataMan 8700 Reader
Weight	DX Corded: 463g (15.90 oz) + ~132g (4.60 oz) cables DX Wireless: 548 g (18.70 oz) (battery included)
	DQ Corded: 395 g (13.90 oz) + ~132 g (4.60 oz) cables DQ Wireless: 479 g (16.90 oz) (battery included)
	LX Corded: 399 g (14.07 oz) + ~132 g (4.60 oz) cables LX Wireless: 483 g (17.03 oz) (battery included)
	HD Corded: 409 g (14.43 oz) + ~132 g (4.60 oz) cables HD Wireless: 493 g (17.39 oz) (battery included)
Operating Temperature	0 °C — 40 °C (32 °F — 104 °F) 1
Storage Temperature	-40 °C — 60 °C (-40 °F — 140 °F)
Maximum Humidity	< 95% (non-condensing)
Environmental	Compliant with latest EU RoHS and China RoHS For indoor use only
Symbologies	<b>1-D barcodes:</b> Codabar, Code 39, Code 128, and Code 93, Interleaved 2 of 5, Postal, UPC/JAN, POSTNET, PLANET Code, GS1 IMB <b>2-D barcodes:</b> MaxiCode, Aztec Code, Data Matrix™, QR Code and microQR Code, PDF 417
Power Supply Requirements	Serial/USB: 5.5 V DC, 6.0 W maximum LPS or NEC Class 2 power supply Ethernet: PoE Class 2 power supply IEEE 802.3at Wireless: 3.6 V, 5000 mAh Li-ion battery
Battery life for wireless reader (typical use case)	The expected life time of the battery is 5 years.
Battery Run/Recharge Times	Charging time through PoE: 10-11 hours Charging time through USB with external power: 6.2 hours
Ethernet	10/100 Base-T FULL/HALF DUPLEX, IEEE 802.3at
Bluetooth (R00082, R00085, and R00086 only)	Bluetooth 4.2, Dual Mode (BR/EDR & Low Energy), 2.4~2.4835 GHz

Specification	DataMan 8700 Reader
Wi-Fi (R00082, R00085, and R00086 only)	IEEE 802.11 a/b/g/n/ac, 2.4~2.4835 GHz and 5.18-5.835 GHz
Protection	ISO 16750-5 IP67 Endures multiple drops from 2.5 m height on concrete

**Note:** A reader triggering at consistently high frequencies may overheat even when below the max operating temperature in some applications or environmental circumstances.

<sup>1</sup> In presentation mode, use the Motion Detection feature to prevent overheating as the reader generates significant heat when triggering constantly.

## DataMan 8700 Base Station Specifications

### Base Station Specifications

Specification	DMB-8700-USB, DMB-8700-RS, DMB-8700-E	DMB-8700-CHARGE
Weight	500 g (17.63 oz)	607 g (21.41 oz)
Operating Temperature	0 °C — 40 °C (32 °F — 113 °F)	
Storage Temperature	-40 °C — 60 °C (-40 °F — 140 °F)	
Maximum Humidity	95% (non-condensing)	

Specification	DMB-8700-USB, DMB-8700-RS, DMB-8700-E	DMB-8700-CHARGE
Power Supply Requirements	5.5 V DC, 6 W maximum LPS or NEC Class 2 power supply or PoE Class 2 power supply	Requirement: 24 V DC, min 0.5 A Consumption: Up to 12 W
Protection	IP65	
Ethernet	10/100 Base-T FULL/HALF DUPLEX, IEEE 802.3	N/A
Bluetooth	Bluetooth 4.2, BR/EDR, 2.4~2.4835 GHz	N/A
Wi-Fi	IEEE 802.11 a/b/g/n/ac, 2.4~2.4835 GHz and 5.18-5.835 GHz	N/A
Charge Time	N/A	< 8 hours
Cable Lengths	N/A	2.5 m + 2.5 m, 5 m total

## LED Wavelengths for DataMan 8700 Readers

**i** **Note:** The data below refer to the LED Illumination accessory of the reader, not to the LED indicators.

The following table shows LED types and the related wavelengths:

Reader Model	LED	$\lambda$ [nm]
DM8700 DX	RED	660
DM8700 DQ	WHITE	N/A
DM8700 LX	AMBER/RED-ORANGE	617
DM8700 HD	AMBER/RED-ORANGE	625

# Regulations and Conformity

The corded DataMan 8700 LX/HD, DX, and DQ readers have Regulatory Model R00081, R00083, and R00084 respectively. The wireless DataMan 8700 LX/HD, DX, and DQ readers have Regulatory Model R00082, R00085, and R00086 respectively and meets or exceeds the requirements of all applicable standards organizations for safe operation. However, as with any electrical equipment, the best way to ensure safe operation is to operate them according to the agency guidelines that follow. Please read these guidelines carefully before using your device.

 **Note:** For the most current CE declaration and regulatory conformity information, see the Cognex support site: [cognex.com/support](http://cognex.com/support).

The following specifications apply to the corded DataMan 8700 LX, HD, DX, and DQ readers:

Regulator	Specification
USA	FCC Part 15, Class A
Canada	ICES-003
European Community	EN 61010-1 EN 61326-1

The following table shows Safety and Regulatory Information for corded readers:

Safety and Regulatory	
Manufacturer	Cognex Corporation One Vision Drive Natick, MA 01760 USA

**Safety and Regulatory**

Corded DataMan 8700 LX and HD: Regulatory Model R00081  
Corded DataMan 8700 DX: Regulatory Model R00083  
Corded DataMan 8700 DQ: Regulatory Model R00084  
This is a Class A product. In a domestic environment this product may cause radio interference in which case the user may be required to take immediate measures. This equipment complies with the essential requirements of the EU Directive 2014/30/EU. Declarations are available from your local representative.

EU RoHS

Compliant to the most recent applicable directive.

FCC

FCC Part 15, Class A  
This equipment has been tested and found to comply with the limits for a Class A digital device, pursuant to part 15 of the FCC Rules. These limits are designed to provide reasonable protection against harmful interference when the equipment is operated in a commercial environment. This equipment generates, uses, and can radiate radio frequency energy and, if not installed and used in accordance with the instruction manual, may cause harmful interference to radio communications. Operation of this equipment in a residential area is likely to cause harmful interference in which case the user will be required to correct the interference at his own expense.

Canada

This Class A digital apparatus complies with Canadian ICES-003. Cet appareil numérique de la classe A est conforme à la norme NMB-003 du Canada.

<b>Safety and Regulatory</b>	
Brazil	<p>Corded DataMan 8700 LX and HD: Regulatory Model R00081            Corded DataMan 8700 DX: Regulatory Model R00083            Corded DataMan 8700 DQ: Regulatory Model R00084            Este equipamento não tem direito à proteção contra interferência prejudicial e não pode causar interferência em sistemas devidamente autorizados.            Para maiores informações, consulte o site da ANATEL <a href="http://www.anatel.gov.br">www.anatel.gov.br</a>.</p>
TÜV	<p>Corded DataMan 8700 LX and HD: Regulatory Model R00081            Corded DataMan 8700 DX: Regulatory Model R00083            Corded DataMan 8700 DQ: Regulatory Model R00084            NRTL: TÜV SÜD SCC/NRTL OSHA Scheme for UL/CAN 61010-1.            CB report available upon request. TÜV SÜD, IEC/EN 61010-1.</p>
Korea 	<p>Corded DataMan 8700 LX and HD: Regulatory Model R00081            Corded DataMan 8700 DX: Regulatory Model R00083            Corded DataMan 8700 DQ: Regulatory Model R00084            This device is certified for office use only and if used at home, there can be frequency interference problems.            이 장치는 사무실 전용으로 인증받았으며, 가정에서 사용할 경우 주파수 간섭 문제가 발생할 수 있습니다.</p>
Mexico	<p>Corded DataMan 8700 LX and HD: Regulatory Model R00081            Corded DataMan 8700 DX: Regulatory Model R00083            Corded DataMan 8700 DQ: Regulatory Model R00084            La operación de este equipo está sujeta a las siguientes dos condiciones:            (1) Es posible que este equipo o dispositivo no cause interferencia perjudicial y            (2) Este equipo o dispositivo debe aceptar cualquier interferencia, incluyendo la que pueda causar su operación no deseada.</p>

The following specifications apply to the DataMan 8700 LX, HD, DX and DQ wireless reader:

Regulator	Specification
USA	FCC Part 15B, Class A FCC Part 15C contains FCC ID: TXH-50165
Canada	ICES-003 RSS 247 contains IC: 6315A-50165
European Community	For Bluetooth and Wi-Fi EN61010-1 EN ETSI 301 489-1/-17 EN ETSI 300 328, EN ETSI 301893, EN ETSI 300440

The following table shows Safety and Regulatory Information for wireless readers:

Safety and Regulatory	
Manufacturer	Cognex Corporation One Vision Drive Natick, MA 01760 USA
	Wireless DataMan 8700 LX and HD: Regulatory Model R00082 Wireless DataMan 8700 DX: Regulatory Model R00085 Wireless DataMan 8700 DQ: Regulatory Model R00086 This is a Class A product. In a domestic environment this product may cause radio interference in which case the user may be required to take immediate measures. This equipment complies with the essential requirements of the EU Directive 2014/53/EU. Declarations are available from your local representative.
EU RoHS	Compliant to the most recent applicable directive.
FCC	FCC Part 15 This device complies with part 15 of the FCC Rules and Industry Canada license-exempt RSS standard(s). Operation is subject to the following two conditions: (1) This device may not cause harmful interference, and (2) this device must accept any interference received, including interference that may cause undesired operation. Changes or modifications not expressly approved by the party responsible for compliance could void the user's authority to operate the equipment.

### Safety and Regulatory

Canada	<p>This device complies with part 15 of the FCC Rules and Industry Canada license-exempt RSS standard(s). Operation is subject to the following two conditions: (1) This device may not cause harmful interference, and (2) this device must accept any interference received, including interference that may cause undesired operation.</p> <p>Le présent appareil est conforme aux Innovation, Science and Economic Development Canada applicables aux appareils radio exempts de licence. L'exploitation est autorisée aux deux conditions suivantes: (1) l'appareil ne doit pas produire de brouillage, et (2) l'utilisateur de l'appareil doit accepter tout brouillage radioélectrique subi, même si le brouillage est susceptible d'en compromettre le fonctionnement.</p>
Brazil	<p>Wireless DataMan 8700 LX and HD: Regulatory Model R00082, ANATEL ID: 07649-22-08330 Wireless DataMan 8700 DX: Regulatory Model R00085, ANATEL ID: 12815-21-08330, 07185-22-08330 Wireless DataMan 8700 DQ: Regulatory Model R00086, ANATEL ID: 12815-21-08330, 07188-22-08330</p> <p>Este produto está homologado pela ANATEL de acordo com os procedimentos regulamentados para avaliação da conformidade de produtos para telecomunicações e atende aos requisitos técnicos aplicados, incluindo os limites de exposição da Taxa de Absorção Específica referente a campos elétricos, magnéticos e eletromagnéticos de radiofrequência. O máximo valor medido da Taxa de Absorção Específica referente à exposição localizada no tronco foi de 0,0009250 W/kg.</p> <p>Para maiores informações, consulte o site da ANATEL <a href="http://www.anatel.gov.br">www.anatel.gov.br</a>.</p>
TÜV	<p>Wireless DataMan 8700 LX and HD: Regulatory Model R00082 Wireless DataMan 8700 DX: Regulatory Model R00085 Wireless DataMan 8700 DQ: Regulatory Model R00086 NRTL: TÜV SÜD SCC/NRTL OSHA Scheme for UL/CAN 61010-1. CB report available upon request. TÜV SÜD, IEC/EN 61010-1.</p>

### Safety and Regulatory

<p>Korea</p> 	<p>Wireless DataMan 8700 LX and HD: Regulatory Model R00082, KC ID: R-R-CGX-R00082            Wireless DataMan 8700 DX: Regulatory Model R00085, KC ID: R-R-CGX-R00085, R-R-CGX-R00085A            Wireless DataMan 8700 DQ: Regulatory Model R00086, KC ID: R-R-CGX-R00086, R-R-CGX-R00086A            This device is certified for office use only and if used at home, there can be frequency interference problems.            이 장치는 사무실 전용으로 인증받았으며, 가정에서 사용할 경우 주파수 간섭 문제가 발생할 수 있습니다.</p>
<p>Mexico</p>	<p>Wireless DataMan 8700 LX and HD: Regulatory Model R00082            Wireless DataMan 8700 DX: Regulatory Model R00085, IFETEL ID: RCPCOR022-1453            Wireless DataMan 8700 DQ: Regulatory Model R00086, IFETEL ID: RCPCOR022-1453-A1            La operación de este equipo está sujeta a las siguientes dos condiciones:            (1) Es posible que este equipo o dispositivo no cause interferencia perjudicial y            (2) Este equipo o dispositivo debe aceptar cualquier interferencia, incluyendo la que pueda causar su operación no deseada.</p>
<p>Taiwan</p>	<p>Wireless DataMan 8700 LX and HD: Regulatory Model R00082            Wireless DataMan 8700 DX: Regulatory Model R00085            Wireless DataMan 8700 DQ: Regulatory Model R00086            取得審驗證明之低功率射頻器材，非經核准，公司、商號或使用者均不得擅自變更頻率、加大功率或變更原設計之特性及功能。低功率射頻器材之使用不得影響飛航安全及干擾合法通信，經發現有干擾現象時，應立即停用，並改善至無干擾時方得繼續使用。前述合法通信，指依電信管理法規規定作業之無線電通信。低功率射頻器材須忍受合法通信或工業、科學及醫療用電波輻射性電機設備之干擾  <b>Warning users:</b>            To avoid electromagnetic interference, this product should not be installed or used in a residential environment.</p>
<p>Japan</p>	<p>Wireless DataMan 8700 LX: Regulatory Model R00082, MIC ID: R 003-210336            Wireless DataMan 8700 DX: Regulatory Model R00085, MIC ID: R 201-210058, R 003-210336            Wireless DataMan 8700 DQ: Regulatory Model R00086, MIC ID: R 201-210058, R 003-210336</p>

**Safety and Regulatory**

China

Wireless DataMan 8700 LX: Regulatory Model R00082, CMIIT ID: 2022AJ1367  
Wireless DataMan 8700 DX: Regulatory Model R00085, CMIIT ID: 2021DJ8188,  
2022AJ1323  
Wireless DataMan 8700 DQ: Regulatory Model R00086, CMIIT ID: 2021DJ15763,  
2022AJ1235

## For European Community Users

Cognex complies with Directive 2012/19/EU OF THE EUROPEAN PARLIAMENT AND OF THE COUNCIL of 4 July 2012 on waste electrical and electronic equipment (WEEE).

This product has required the extraction and use of natural resources for its production. It may contain hazardous substances that could impact health and the environment, if not properly disposed.

In order to avoid the dissemination of those substances in our environment and to diminish the pressure on the natural resources, we encourage you to use the appropriate take-back systems for product disposal. Those systems will reuse or recycle most of the materials of the product you are disposing in a sound way.



The crossed out wheeled bin symbol informs you that the product should not be disposed of along with municipal waste and invites you to use the appropriate separate take-back systems for product disposal.

If you need more information on the collection, reuse, and recycling systems, please contact your local or regional waste administration.

You may also contact your supplier for more information on the environmental performance of this product.

## Compliance Statements: DataMan Wireless Base Station

The DataMan Wireless Base Station has the Regulatory model R00087 and meets or exceeds the requirements of all applicable standards organizations for safe operation. However, as with any electrical equipment, the best way to ensure safe operation is to operate them according to the agency guidelines that follow.

 **Note:** For the most current CE declaration and regulatory conformity information, see the Cognex support site: [cognex.com/support](http://cognex.com/support).

Please read these guidelines carefully before using your device.

Regulator	Specification
USA	FCC Part 15B, Class A FCC Part 15C contains FCC ID: TXH-50165
Canada	ICES-003 RSS 247 contains IC: 6315A-50165
European Community	For Bluetooth and WiFi EN61010-1 EN ETSI 301 489-1/-17 EN ETSI 300 328, EN ETSI 301893, EN ETSI 300440

Safety and Regulatory	
Manufacturer	Cognex Corporation One Vision Drive Natick, MA 01760 USA
	Intelligent Base Station: Regulatory Model R00090 This is a Class A product. In a domestic environment this product may cause radio interference in which case the user may be required to take immediate measures. This equipment complies with the essential requirements of EU Directive 2014/53/EU. Declarations are available from your local representative.

<b>Safety and Regulatory</b>	
EU RoHS	Compliant to the most recent applicable directive.
FCC	<p>FCC Part 15            This device complies with part 15 of the FCC Rules and Industry Canada license-exempt RSS standard(s). Operation is subject to the following two conditions:</p> <p>(1) This device may not cause harmful interference, and            (2) this device must accept any interference received, including interference that may cause undesired operation.</p> <p>Changes or modifications not expressly approved by the party responsible for compliance could void the user's authority to operate the equipment.</p>
Canada	<p>This device complies with part 15 of the FCC Rules and Industry Canada license-exempt RSS standard(s). Operation is subject to the following two conditions:</p> <p>(1) This device may not cause harmful interference, and            (2) this device must accept any interference received, including interference that may cause undesired operation.</p> <p>Le présent appareil est conforme aux Innovation, Science and Economic Development Canada applicables aux appareils radio exempts de licence. L'exploitation est autorisée aux deux conditions suivantes:</p> <p>(1) l'appareil ne doit pas produire de brouillage, et            (2) l'utilisateur de l'appareil doit accepter tout brouillage radioélectrique subi, même si le brouillage est susceptible d'en compromettre le fonctionnement.</p>
Brazil	<p>DMB-8700-RS, DMB-8700-USB, and DMB-8700-E DataMan Base Station: Regulatory Model R00087, ANATEL ID: 13026-21-08330, 06820-22-08330            Este produto está homologado pela ANATEL de acordo com os procedimentos regulamentados para avaliação da conformidade de produtos para telecomunicações e atende aos requisitos técnicos aplicados, incluindo os limites de exposição da Taxa de Absorção Específica referente a campos elétricos, magnéticos e eletromagnéticos de radiofrequência. O máximo valor medido da Taxa de Absorção Específica referente à exposição localizada no tronco foi de 0,0009250 W/kg.            Para maiores informações, consulte o site da ANATEL <a href="http://www.anatel.gov.br">www.anatel.gov.br</a>.</p>
TÜV	<p>DMB-8700-RS, DMB-8700-USB, and DMB-8700-E DataMan Base Station: Regulatory Model R00087            NRTL: TÜV SÜD SCC/NRTL OSHA Scheme for UL/CAN 61010-1.            CB report available upon request. TÜV SÜD, IEC/EN 61010-1.</p>

<b>Safety and Regulatory</b>	
Korea	DMB-8700-RS, DMB-8700-USB, and DMB-8700-E DataMan Base Station: Regulatory Model R00087, KC ID: R-R-CGX-R00087 This device is certified for office use only and if used at home, there can be frequency interference problems. 이 장치는 사무실 전용으로 인증받았으며, 가정에서 사용할 경우 주파수 간섭 문제가 발생할 수 있습니다.
Mexico	La operación de este equipo está sujeta a las siguientes dos condiciones: (1) Es posible que este equipo o dispositivo no cause interferencia perjudicial y (2) Este equipo o dispositivo debe aceptar cualquier interferencia, incluyendo la que pueda causar su operación no deseada.
Taiwan	取得審驗證明之低功率射頻器材，非經核准，公司、商號或使用者均不得擅自變更頻率、加大功率或變更原設計之特性及功能。低功率射頻器材之使用不得影響飛航安全及干擾合法通信；經發現有干擾現象時，應立即停用，並改善至無干擾時方得繼續使用。前述合法通信，指依電信管理法規定作業之無線電通信。低功率射頻器材須忍受合法通信或工業、科學及醫療用電波輻射性電機設備之干擾 Warning users: To avoid electromagnetic interference, this product should not be installed or used in a residential environment.
Japan	DMB-8700-RS, DMB-8700-USB, and DMB-8700-E DataMan Base Station: Regulatory Model R00087, MIC ID: R 201-210058, R 003-210336
China	DMB-8700-RS, DMB-8700-USB, and DMB-8700-E DataMan Base Station: Regulatory Model R00087, CMIIT ID: 2021DJ8199, 2022AJ1646

## Compliance Statements: DataMan Charging Base Station

The DataMan Charging Base Station has the Regulatory model R00090 and meets or exceeds the requirements of all applicable standards organizations for safe operation. However, as with any electrical equipment, the best way to ensure safe operation is to operate them according to the agency guidelines that follow.

**i Note:** For the most current CE declaration and regulatory conformity information, see the Cognex support site: [cognex.com/support](http://cognex.com/support).

Please read these guidelines carefully before using your device.

Safety and Regulatory	
Manufacturer	Cognex Corporation One Vision Drive Natick, MA 01760 USA
<b>CE</b>	Charging Base Station: Regulatory Model R00090 This is a Class A product. In a domestic environment this product may cause radio interference in which case the user may be required to take immediate measures. This equipment complies with the essential requirements of EU Directive 2014/53/EU. Declarations are available from your local representative.
EU RoHS	Compliant to the most recent applicable directive.
FCC	FCC Part 15, Class A This equipment has been tested and found to comply with the limits for a Class A digital device, pursuant to part 15 of the FCC Rules. These limits are designed to provide reasonable protection against harmful interference when the equipment is operated in a commercial environment. This equipment generates, uses, and can radiate radio frequency energy and, if not installed and used in accordance with the instruction manual, may cause harmful interference to radio communications. Operation of this equipment in a residential area is likely to cause harmful interference in which case the user will be required to correct the interference at his own expense.
Canada	This Class A digital apparatus complies with Canadian ICES-003. Cet appareil numérique de la classe A est conforme à la norme NMB-003 du Canada.
TÜV	Charging Base Station: Regulatory Model R00090 NRTL: TÜV SÜD SCC/NRTL OSHA Scheme for UL/CAN 61010-1. CB report available upon request. TÜV SÜD, IEC/EN 61010-1.
Korea	Charging Base Station: Regulatory Model R00090, KC ID: R-R-CGX-R00090

# 中国大陆RoHS (Information for China RoHS Compliance)

根据中国大陆《电子信息产品污染控制管理办法》(也称为中国大陆RoHS),以下部份列出了本产品中可能包含的有毒有害物质或元素的名称和含量。



Table of toxic and hazardous substances/elements and their content, as required by China's management methods for controlling pollution by electronic information products.

Part Name 部件名称	Hazardous Substances 有害物质					
	Lead (Pb) 铅	Mercury (Hg) 汞	Cadmium (Cd) 镉	Hexavalent Chromium (Cr (VI)) 六价铬	Polybrominated biphenyls (PBB) 多溴联苯	Polybrominated diphenyl ethers (PBDE) 多溴二苯醚
Regulatory Model R00081	X	O	O	O	O	O
Regulatory Model R00082						
Regulatory Model R00083						
Regulatory Model R00084						
Regulatory Model R00085						
Regulatory Model R00086						
Regulatory Model R00087						
Regulatory Model R00090						

This table is prepared in accordance with the provisions of SJ/T 11364.

这个标签是根据SJ/T 11364的规定准备的。

**O:** Indicates that said hazardous substance contained in all of the homogeneous materials for this part is below the limit requirement of GB / T26572 - 2011.

表示本部件所有均质材料中含有的有害物质低于GB / T26572 - 2011的限量要求。

**X:** Indicates that said hazardous substance contained in at least one of the homogeneous materials used for this part is above the limit requirement of GB / T26572 - 2011.

表示用于本部件的至少一种均质材料中所含的危害物质超过GB / T26572 - 2011的限制要求。



Copyright © 2023  
Cognex Corporation. All Rights Reserved.