

## DataMan<sup>®</sup> 475 Verifier Reference Manual

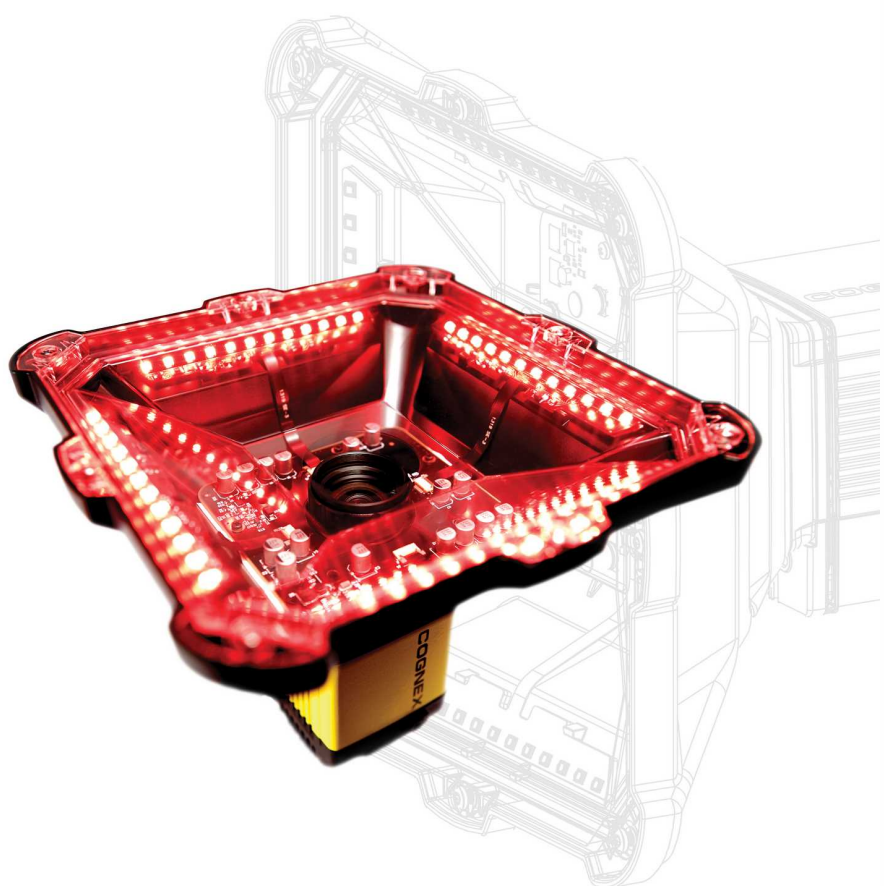

2023 March 28  
Revision: 23.1.0.9

# Legal Notices

The software described in this document is furnished under license, and may be used or copied only in accordance with the terms of such license and with the inclusion of the copyright notice shown on this page. Neither the software, this document, nor any copies thereof may be provided to, or otherwise made available to, anyone other than the licensee. Title to, and ownership of, this software remains with Cognex Corporation or its licensor. Cognex Corporation assumes no responsibility for the use or reliability of its software on equipment that is not supplied by Cognex Corporation. Cognex Corporation makes no warranties, either express or implied, regarding the described software, its merchantability, non-infringement or its fitness for any particular purpose.

The information in this document is subject to change without notice and should not be construed as a commitment by Cognex Corporation. Cognex Corporation is not responsible for any errors that may be present in either this document or the associated software.

Companies, names, and data used in examples herein are fictitious unless otherwise noted. No part of this document may be reproduced or transmitted in any form or by any means, electronic or mechanical, for any purpose, nor transferred to any other media or language without the written permission of Cognex Corporation.

Copyright © 2021. Cognex Corporation. All Rights Reserved.

Portions of the hardware and software provided by Cognex may be covered by one or more U.S. and foreign patents, as well as pending U.S. and foreign patents listed on the Cognex web site at: [cognex.com/patents](http://cognex.com/patents).

---

The following are registered trademarks of Cognex Corporation:

Cognex, 2DMAX, Advantage, AlignPlus, Assemblyplus, Check it with Checker, Checker, Cognex Vision for Industry, Cognex VSOC, CVL, DataMan, DisplayInspect, DVT, EasyBuilder, Hotbars, IDMax, In-Sight, Laser Killer, MVS-8000, OmniView, PatFind, PatFlex, PatInspect, PatMax, PatQuick, SensorView, SmartView, SmartAdvisor, SmartLearn, UltraLight, Vision Solutions, VisionPro, VisionView

The following are trademarks of Cognex Corporation:

The Cognex logo, 1DMax, 3D-Locate, 3DMax, BGAll, CheckPoint, Cognex VSoC, CVC-1000, FFD, iLearn, In-Sight (design insignia with cross-hairs), In-Sight 2000, InspectEdge, Inspection Designer, MVS, NotchMax, OCRMax, PatMax RedLine, ProofRead, SmartSync, ProfilePlus, SmartDisplay, SmartSystem, SMD4, VisiFlex, Xpand

Portions copyright © Microsoft Corporation. All rights reserved.

Portions copyright © MadCap Software, Inc. All rights reserved.

Other product and company trademarks identified herein are the trademarks of their respective owners.

# Table of Contents

<b>Legal Notices</b> .....	<b>2</b>
<b>Table of Contents</b> .....	<b>3</b>
<b>Symbols</b> .....	<b>6</b>
<b>Getting Started</b> .....	<b>7</b>
About the DataMan 475 Verifier .....	7
Supporting Documentation .....	7
DataMan 475 Verifier Accessories .....	8
Cables and Power Supply .....	8
Mounting Brackets .....	9
DataMan 475 Verifier Systems .....	9
<b>Setting Up Your DataMan 475 Verifier</b> .....	<b>10</b>
Reader Layout .....	10
Dimensions .....	12
DataMan 475 Verifier .....	12
DataMan 475 Verifier DPM .....	12
Removing Illumination Attachment .....	13
Additional Information .....	17
DataMan 475 Verifier and DPM Specifications .....	17
DataMan 475 Series Verifier Imager Specifications .....	19
LED Wavelengths .....	20
Calibration .....	21
<b>User Interface</b> .....	<b>25</b>
Toolbar .....	25
<b>Using Your DataMan 475 Verifier</b> .....	<b>26</b>
Verifying a 2D Barcode .....	26
Selecting Regions .....	27
Standards Based Grading .....	28
Verifications of Multiple Symbols .....	28
<b>Examining the Results</b> .....	<b>30</b>
1D & 2D Verification .....	30
Main Tab .....	30
General Characteristics Tab .....	31
Data Detail Tab .....	32
Modulation table legend .....	34
Quality Detail Tab .....	34
Advanced Detail Tab .....	35
Histogram Tab .....	36
Report Tab .....	37
<b>Settings</b> .....	<b>38</b>
The Settings Menu .....	38
Application Settings .....	39
Dot Peen .....	40

Min X-Dimension (mils) .....	40
Max X-Dimension (mils) .....	41
Pass Grade .....	41
Application Standards Settings .....	41
GS1 .....	42
UID (MIL-STD-130) .....	43
UDI (GS1 or HIBCC) .....	43
Auto .....	44
Cryptocode .....	44
Custom .....	44
Grading Standards .....	49
ISO/IEC 15416 (ANSI x3.182) Grading Parameters .....	50
ISO/IEC 15415 Grading Parameters .....	51
ISO/IEC 29158 2006 Grading Parameters .....	54
ISO/IEC 18004 QR Code Grading Parameters .....	57
Traditional (Non-Graded) Parameters .....	58
Calibration Settings .....	58
Trending Settings .....	58
User Information .....	59
Report Settings .....	60
Navigation .....	61
Results through Setup Tool (local machine) .....	61
Result Type .....	61
Result Formatting/Scripting .....	62
Results through FTP .....	62
Image FTP Settings .....	62
Result FTP Settings .....	63
Report (scripting) FTP Settings .....	63
Symbologies/Multi Mode .....	64
Symbologies/Number of Symbols .....	64
Scripting .....	64
Setting Up FTP Transfer .....	65
Image FTP Transfer .....	66
Result FTP Transfer .....	66
Report FTP Transfer .....	67
<b>Setting Up DataMan Setup Tool .....</b>	<b>68</b>
Reading your first Code .....	68
External Triggers .....	70
<b>Cleaning and Maintenance .....</b>	<b>71</b>
Cleaning the Verifier Housing .....	71

Cleaning the Verifier Lens Cover .....	71
<b>Compliance Information, Warnings and Notices .....</b>	<b>72</b>
Precautions .....	72
Regulations/Conformity .....	73
For European Community Users .....	73

# Symbols

The following symbols indicate safety precautions and supplemental information:

---

 **WARNING:** This symbol indicates a hazard that could cause death, serious personal injury or electrical shock.

---

---

 **CAUTION:** This symbol indicates a hazard that could result in property damage.

---

---

 **Note:** This symbol indicates additional information about a subject.

---

---

 **Tip:** This symbol indicates suggestions and shortcuts that might not otherwise be apparent.

---

# Getting Started

This section provides general information about the DataMan 475 Verifier and the DataMan 475 Verifier accessories and systems.

## About the DataMan 475 Verifier



The DataMan 475 Verifier provides immediate quality assurance benefits:

- Sets alerts for when code quality begins to degrade
- Grades up to 20 codes per second
- Exports verification results to PLC, database, or FTP server as CSV, HTML, PDF, and custom formats
- Improves processes with detailed analysis and diagnostic information for every code

The DataMan 475 Verifier LabelLight utilizes a four-quadrant, 45-degree lighting attachment and the DataMan 475 DPM utilizes either a four-quadrant 30-degree, 45-degree, or 90-degree lighting attachment. Both types of 475 verifiers are compliant with the International Organization for Standardization (ISO) requirements for grading 1D and 2D label-based barcodes. The included calibration card and robust grading algorithms ensure that the DataMan 475 Verifiers conform to ISO and application standards while providing accurate and repeatable results.

The DataMan 475 Verifiers are packaged in a rugged, IP65-rated housing, and provide numerous ease-of-use features, including one button to trigger and one button to start tuning.

## Supporting Documentation

This document provides basic information about how to configure and use the DataMan 475 Verifier. Additional information is available through the Windows **Start** menu or the DataMan Setup Tool **Help** menu once installing the DataMan software on your PC:

- The **DataMan Communications and Programming Guide** shows you how to integrate your DataMan verifier into your particular automation and factory environment.

Cognex->DataMan Software v x.x.x->Documentation->Communications->DataMan Communications and Programming Guide

- The **DataMan Industrial Protocols Manual** provides information on how to integrate DataMan verifier into your particular environment using industrial protocols.

Cognex->DataMan Software v x.x.x->Documentation->Communications->DataMan Industrial Protocols Manual

- The **DataMan Reader Configuration Codes** document provides printable 2-D codes that you can use to configure the DataMan verifier.  
Cognex->DataMan Software v x.x.x->Documentation->English->Reader Configuration Codes
- The **DataMan 475 Verifier Quick Reference Guide** provides essential information about the DataMan 475 Verifier.  
Cognex->DataMan Software v x.x.x->Documentation->English->DM475V Series->DM475V Quick Reference Guide
- The **DataMan Fixed-Mount Readers Reference** is a complete online hardware reference for the DataMan fixed-mount ID verifier.  
Cognex->DataMan Software v x.x.x->Documentation->English->DM475V ->Fixed-Mount Reference Manual
- The **DataMan Control Commands** lists DataMan Control Commands with all relevant information. You can view this help inside the Setup Tool or as a stand-alone help file.  
Cognex->DataMan Software v x.x.x->Documentation->English->DataMan Control Commands
- The **Setup Tool Reference Manual** describes the user interface of the DataMan Setup Tool software.  
Cognex->DataMan Software v x.x.x->Documentation->English->Setup Tool Reference Manual
- The **Release Notes** list detailed system requirements and additional information about this DataMan software release.  
Cognex->DataMan Software v x.x.x->Documentation->DataMan v x.x.x Release Notes

## DataMan 475 Verifier Accessories





**Note:** For ISO compliant verification, equip the DM475V with LabelLight 45° lighting accessory (DMV-475V-LBL-0200). Use other light accessories for DM475V for Standards Based Grading only.



**Note:** The product images below serve illustration purposes only. You can purchase the following components separately. For a list of options and accessories, contact your local Cognex sales representative.

## Cables and Power Supply



**Note:** Cables are sold separately.

**CAUTION:** All cable connectors are keyed to fit the connectors on the verifier. Do not force the connections or damage may occur.

Accessory Name	Accessory Product Number	Accessory Illustration
Power and I/O Breakout Cable, M12-12 to Flying Lead	CCB-PWRIO- xx (straight, xx specifies length: 5m, 10m, 15m) CCB-PWRIO-xxR (right-angled, xx specifies length: 5m, 10m, 15m)	
X-Coded to A-Coded Ethernet cable adapter, 0.5 m	CCB-M12X8MS-XCAC	
Ethernet Cable, X-coded M12-8 to RJ-45	CCB-84901-2001-xx (straight, xx specifies length: 2m, 5m, 10m, 15m, 30m)	
I/O extension cable, straight, 5 m	CKR-200-CBL-EXT	

Accessory Name	Accessory Product Number	Accessory Illustration
Connection module (up to 4 cameras including network switch) xx can be EU, UK, or JP	DMA-CCM-4X-xx	
Connection module (1 camera) xx can be US, EU, UK, or JP	DMA-CCM-1-xx	

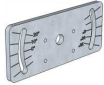
## Mounting Brackets

Accessory Name	Accessory Product Number	Accessory Illustration
Mounting Bracket Kit	DMBK-470-MNT	
Pivot Mounting Bracket	DM100-PIVOTM-00	
External Heat Sink	DMHS-370-470	

## DataMan 475 Verifier Systems

	Symbologies	Light Configurations	Verification Standards
DMV-475V-LBL-0200	1D, 2D, DPM	45° LabelLight	ISO/IEC 15415, 15416, 29158
DMV-475V-DPM-0100	1D, 2D, DPM	30°, 45°, 90° DPM	ISO/IEC 15415, 15416, 29158

# Setting Up Your DataMan 475 Verifier

This section provides information on the physical appearance of the DataMan 475 Verifier . It also details the steps of installing the lenses and filters of the verifier, and gives information on the imager.

## Reader Layout

The following image shows the lighting system of the DataMan 475 Verifier and the mounting holes underneath the plastic lighting cover.

Item	Description
1	Lens
2	Label Light attachment
3	Mounting holes (M3 x 5 mm)
4	Indicator light ring
5	Ethernet connection
6	External lighting connection (disabled for verification)
7	Breakout cable connection
8	DPM Light attachment

The image shows the back cover of the DataMan 475 Verifier and the functions of the indicator lights.

Item	Description
1	Trigger button

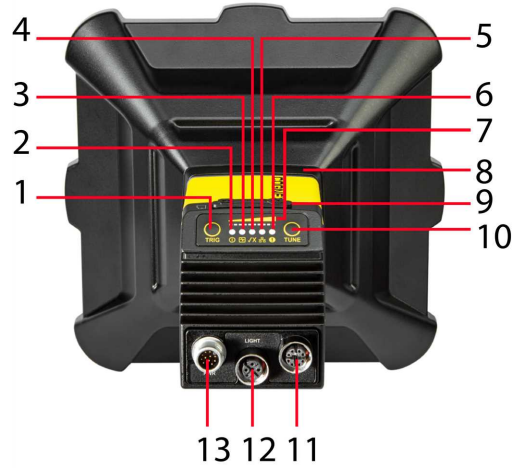

Item	Description
2	Power
3	Train status
4	Good/bad read
5	Network
6	Error
7	Peak meter
8	Indicator light ring
9	SD card slot
10	Tuning button
11	Ethernet
12	External light control
13	Power, I/O, and RS-232

The table explains the indicator light ring behavior.

Type	Signal	Color	Meaning
Status	Power	GREEN	Power ON
	Train status	GREEN	Trained
		YELLOW	Untrained
Error	RED	Error - check device log	
Action	Good/bad read	GREEN	Good read
		RED	Bad read
	Communication	YELLOW	Link up
		<i>blink</i>	Activity
Peak meter	-	Decode yield, train progress/quality	

## Dimensions

**Note:**



- Dimensions are in millimeters [inches] and are for reference purposes only.
- All specifications are for reference purposes only and can change without notice.

Observe the following DataMan 475 Verifier dimensions when installing your reader.

### DataMan 475 Verifier

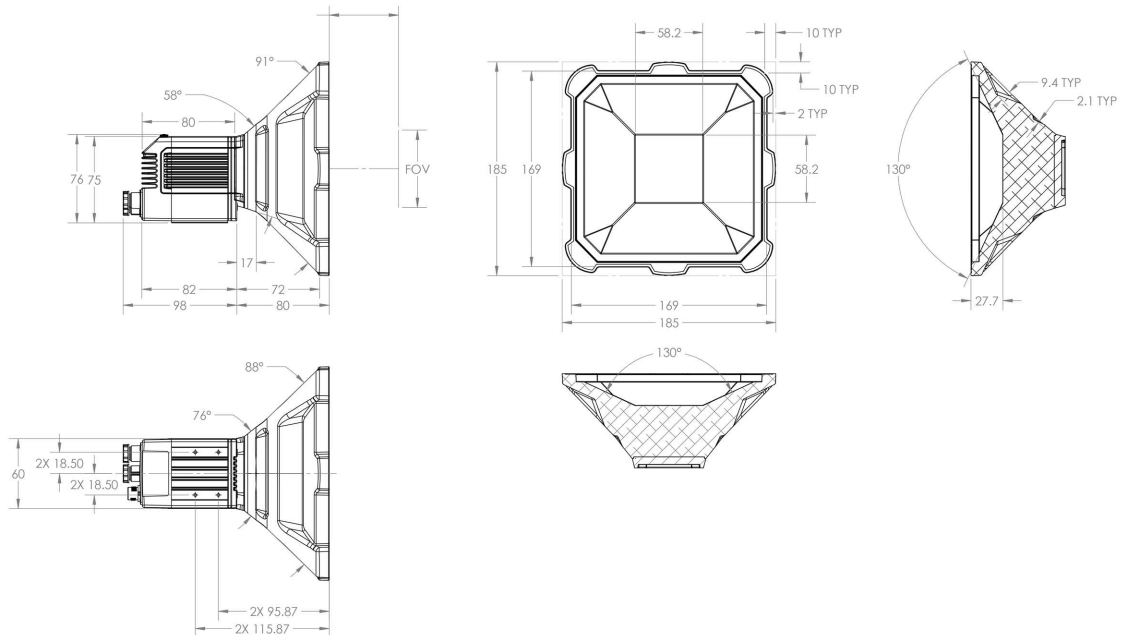

### DataMan 475 Verifier DPM

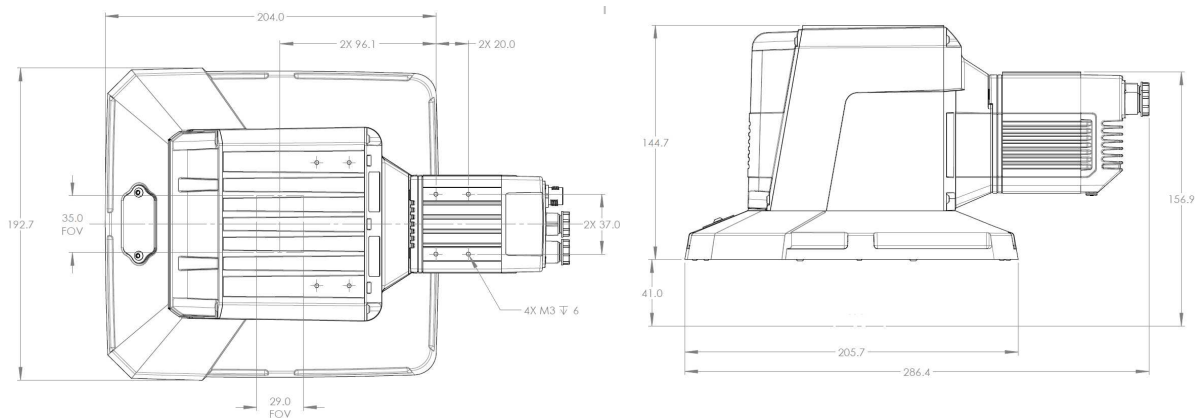

## Removing Illumination Attachment

You can remove the illumination attachment from the reader.

Perform the following steps to safely remove the illumination attachment:

1. Remove the marked screws then pull the side illumination attachment away.

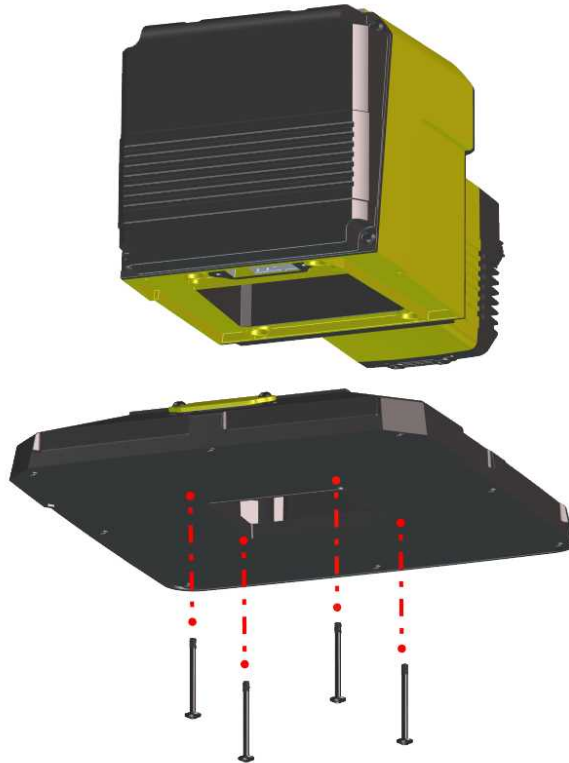

2. Remove the screws of the cover plate located on the top of the illumination attachment.

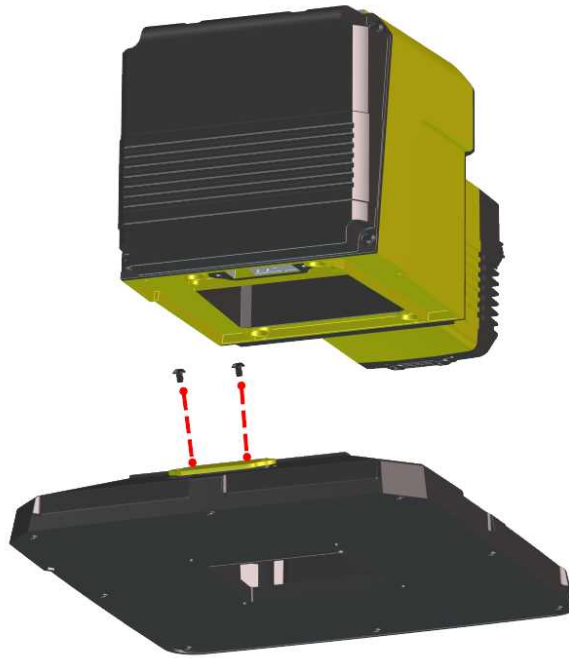

3. Pull the cover plate off from the top of the lighting attachment.

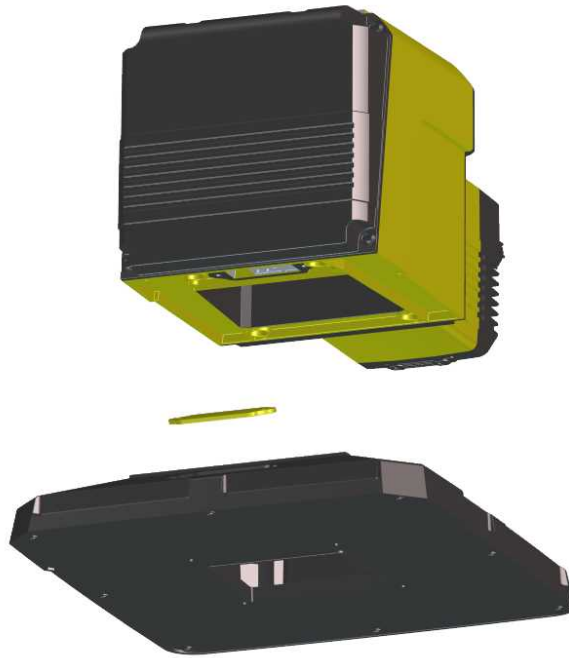

4. Install the cover plate on the underside of the main housing.

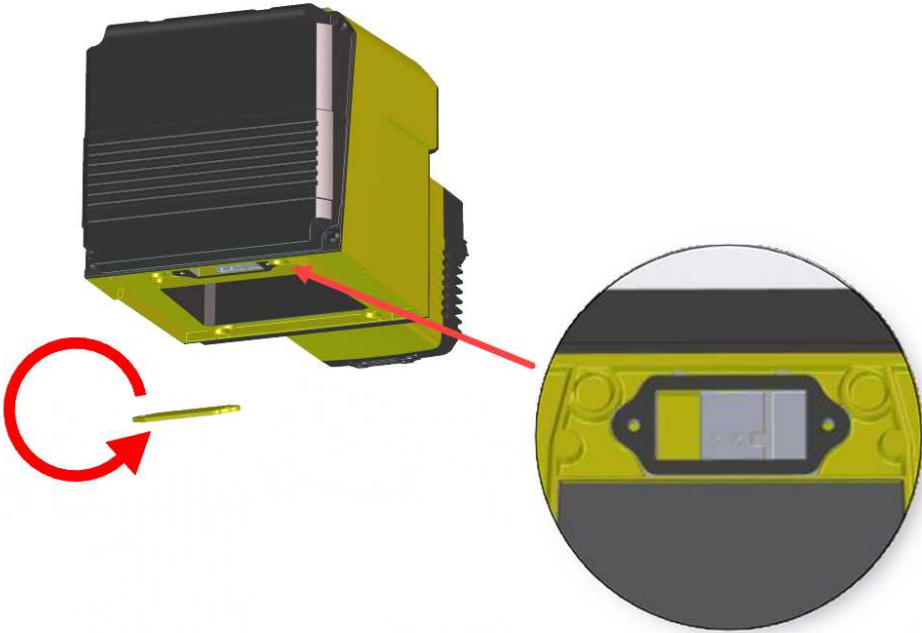

5. Fit the cover plate in place and tighten the screws with a torque value of 0.35 Nm for sealing.

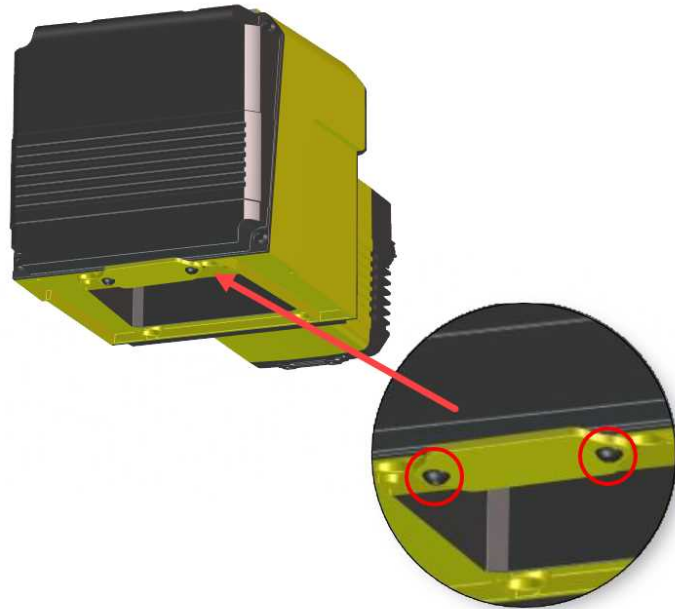

To reattach illumination attachment, follow this procedure in reversed order, than tighten the screws with a torque value of 0.35 Nm for sealing

## Additional Information

### DataMan 475 Verifier and DPM Specifications

Specification	DataMan 475 Verifier	DataMan 475V DPM
Lighting Types	660 nm, 45o, 4-quadrant	660 nm, 45o, 4-quadrant 660 nm, 30o, 1-quadrant, 2-quadrant, 4-quadrant 660 nm, 90o
Minimum X-Dimension	6 mil (0.15 mm)	3.75 mil (0.095 mm)
Working Distance	60 mm	41 mm

Specification	DataMan 475 Verifier	DataMan 475V DPM
Depth of Field (Working Distance tolerance)	+/- 3 mm	5 mil symbols: +/- 1.5 mm 15 mil symbols: +/- 2.5 mm
Weight	945 g	1002.7 g
Field of View	80 x 60 mm	35 x 29 mm
Dimensions	185 x 185 x 175 mm	286 x 144 x 190 mm
Lens Type	12 mm fixed focal length, f/4 fixed aperture, 2/3 inch sensor format, C-mount lens (you cannot alter lens)	35 mm fixed focal length, f/4 fixed aperture, 2/3 inch sensor format, C-mount lens (users cannot alter lens)
Power Consumption	24 VDC ±10%, 1.5 A maximum (Label Light, 36 W peak power consumption) Supplied by LPS or NEC class 2 only.	
Light Connector	0.4 A  <b>Note:</b> The Light Connector is disabled while the LabelLight or DPM accessory is in place.	
Case Temperature <sup>1</sup>	0°C – 57°C (32°F – 134.6°F)	
Operating Temperature <sup>2</sup>	0 °C – 40°C (32 °F – 104°F)	
Storage Temperature	-20°C – 80°C (-4°F – 176°F)	
Humidity	< 95% non-condensing	
Environmental characteristics	IP65	IP65 with cables and appropriate lens cover attached.
Shock (Shipping and Storage)	IEC 60068-2-27: 18 shocks (3 shocks in each polarity in each (X, Y, Z) axis) 80 Gs (800 m/s <sup>2</sup> at 11 ms, half-sinusoidal) with cables or cable plugs and appropriate lens cover attached.	-
Vibration (Shipping and Storage)	IEC 60068-2-6: vibration test in each of the three main axis for 2 hours @ 10 Gs (10 to 500 Hz at 100 m/s <sup>2</sup> / 15 mm) with cables or cable plugs and appropriate lens cover attached.	-
Supported Symbologies	1D codes: Codabar, Code 39, Code 128, and Code 93, Interleaved 2 of 5, UPC/EAN/JAN 2D codes: Data Matrix (ECC 200), QR Code, microQR Code Stacked codes: PDF 417	
Maximum Codes per Second	1D: 20 codes/second* 2D: 10 codes/second*	2D: 10 codes/second*
Maximum Linear Line Speed	3.6 ft/second (1.1 m/second)	4.6 ft/second (1.4 m/second)
Coplanarity Tolerance	+/- 3o of coplanar	+/- 2o of coplanar
Approvals	CE, TUV, FCC, KC	

Specification	DataMan 475 Verifier	DataMan 475V DPM	
Industry Standards Compliance	ISO/IEC 15415, ISO/IEC 15416, ISO/IEC 20158, ISO/IEC 15426-1. ISO/IEC 15426-2		
Application Standards	GS1, MIL-STD 130, UID, UDI, HIBCC, ISO 15434, Russian Crypto-code, Custom Application Standards		
Discrete I/O operating limits	HS Output 0,1,2,3	$I_{MAX}$ @ 12 VDC	50 mA
		$R_{MIN}$	200 $\Omega$
	Input 0 (Trigger)	$V_{IH}$	$\pm 15 - \pm 28$ V
	Input 1,2,3	$V_{IL}$	$0 - \pm 5$ V
		$I_{TYP}$ @ 12 VDC	2.0 mA
		@ 24 VDC	4.2 mA
Ethernet Speed	10/100/1000		
Image Sensor	2/3 inch CMOS, global shutter		
Image Sensor Properties	8.8 mm x 6.6 mm (H x V); 3.45 $\mu$ m square pixels		
Image Resolution (pixels)	2448 x 2048		

1  
Additional cooling measures may be required to keep the case temperature from exceeding 50°C. Examples of such measures include: extra heat sinking and/or air movement.

2  
In situations where the operating temperature exceeds 40 °C, an external heat sink is required.

### DataMan 475 Series Verifier Imager Specifications

Specification	DataMan 475 Imager
Image Sensor	2/3 inch CMOS, global shutter
Image Sensor Properties	8.8 mm x 6.6 mm (H x V); 3.45 $\mu$ m square pixels
Image Resolution (pixels)	2448 x 2048
Electronic Shutter Speed	Minimum exposure: 15 $\mu$ s Maximum exposure: 5000 $\mu$ s Typically set at 30 $\mu$ s by calibration process for ISO 15415.
	<b>Note:</b> If the user adjusts the shutter speed, there is no guarantee that the verifier retains compliance.
Image Acquisition at Full Resolution	37 Hz for imager without lighting.
	<b>Note:</b> Max. acquisition speed with 45 lighting degree accessory enabled is significantly less. Practical acquisition rate is application dependent.

## LED Wavelengths

The following table shows LED types and the related peak wavelengths:

LED	$\lambda$ [nm]
RED	660

# Calibration

Calibration informs the verifier about the grey scale levels and pixel dimensions of the verifier. This way, the verifier can report Symbol Contrast and X-dimension in true physical units.

For ISO compliant barcode verification, make sure that the verifier is in a calibrated state.

For Standards Based Grading, the verifier does not report all quality parameters without calibration.

In an uncalibrated state the verifier does not report:

- Aperture and Symbol Contrast (SC) for ISO/IEC 15415/15416 applications
- Minimum Reflectance (MR) for ISO/IEC TR29158 (AIM-DPM) applications

**Note:** In an uncalibrated state, the verifier does not report aperture value, but uses the default aperture selection: Auto 50% for 1D applications or Auto 80% for 2D applications.

To calibrate the DataMan 475 Verifier:

1. Click the **Calibration** icon in the top left corner in the TruCheck Verification window.
2. Enter the **Rmax** and **Rmin** values from the calibration card.

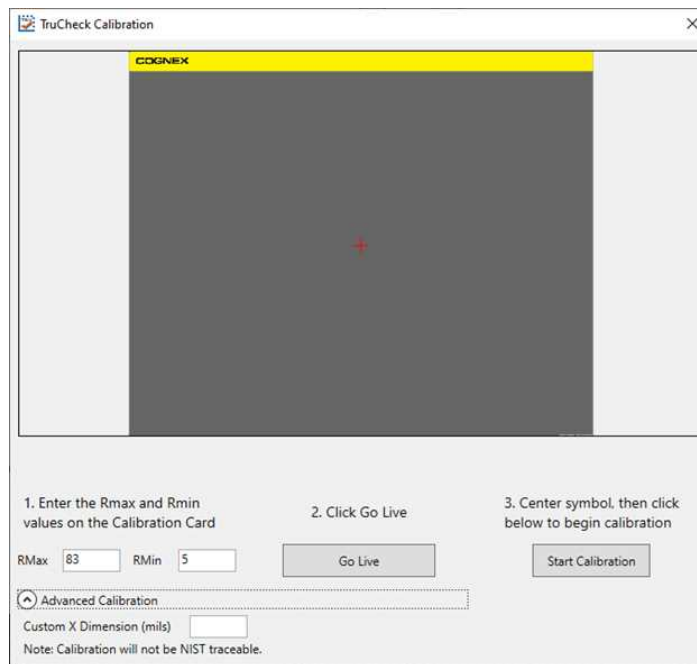

Use the Advanced Calibration option only if you use a non-NIST traceable calibration symbol. This option allows you to enter the Custom X-Dimension (mils) value of the barcode that you use to calibrate the unit. The calibration process uses the Custom X-Dimension (mils) value to calibrate dimension measurements.

3. Click **Center Target**.
4. A live image appears in the **Calibration** screen. Center the verifier over the calibration symbol.
5. Clicking **Start Calibration** prompts a Calibrating progress bar appear in the window



6. If the calibration is successful, one of two messages pop-up.

If you performed the calibration with one of the supported NIST-traceable calibration symbols, the pop-up displays the following :

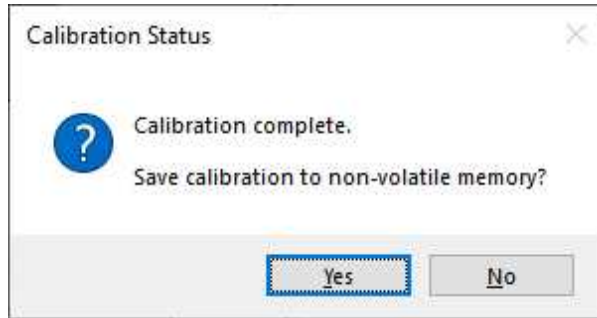

When you perform a successful calibration with a supported NIST-traceable calibration symbol, a calibration time date stamp appears on the bottom of the TruCheck window and is printed in the header of the report. For the list of NIST-traceable calibration symbols see the step list below.

If you performed the calibration successfully with any readable symbol other than the supported NIST-traceable calibration symbols, the pop-up displays the following:

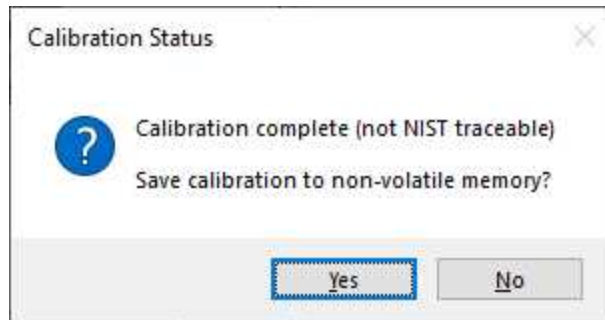

If you perform a successful calibration with a non NIST-traceable calibration symbol, no calibration date is recorded on the reports or displayed on the Main tab in the TruCheck window. Instead, The message reads "Calibration Complete (not NIST-traceable)".

If the calibration failed, see step 8.

7. For both successful calibration messages, you have the options to **Save Calibration** to non-volatile memory

If you select **Yes**, the unit saves the calibration for subsequent verifications and the values to non-volatile memory. If you power down the unit, the calibration will persist.

If you select **No**, the unit saves the calibration for subsequent verifications but does not save the values to non-volatile memory. If you power down the unit, the calibration values will be lost.

8. If the calibration failed, the pop-up displays the following message:

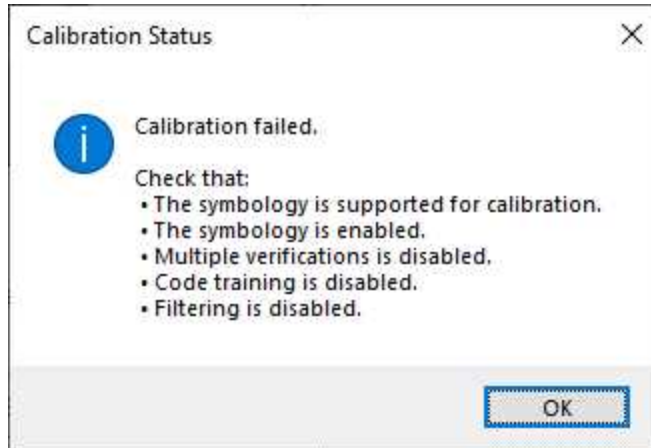

A failed calibration means that the calibration target was not detected. Ensure that:

- a valid, readable barcode is visible within the field of view
- you have selected the region of interest that includes the barcode that you use for calibration
- the calibration barcode symbology type is supported
- the calibration barcode symbology type is enabled in **Code Details** tab in the **Setup Tool** window.
- the unit is not set for multiple verifications
- no filtering is enabled

Supported NIST calibration symbols:

- 1D and 2D symbols on the Cognex Calibration Card (Cognex #DMV-CCC)
- Symbols 1 and 5 on the Applied Image Conformance Calibration Standard Enhanced Test Card for ISO IEC Datamatrix and GS1 Datamatrix (Cognex #DMV-DMCC)
- Symbol 1 on the GS1 ISO/IEC Data Matrix & GS1 Datamatrix Calibrated Conformance Standard Test Card (Cognex #DMV-GS1CC)
- EAN-13 MASTER GRADE and UPC-A MASTER GRADE symbols on the GS1 Calibrated Conformance Standard Test Card for EAN/UPC Symbol Verifiers (Cognex #DMV-AICC)

Calibrate your verifier as needed to ensure accurate verification results. Monthly calibration is recommended, or more frequently where required by internal quality guidelines.

**Note:** Store the calibration card away from direct light to avoid compromising the calibration symbol.

Enable a calibration reminder in Calibration Settings to alert you about the next scheduled calibration. After enabling the calibration reminder, set the number of days for prompting a calibration reminder. For more information, see [Calibration Settings on page 58](#)



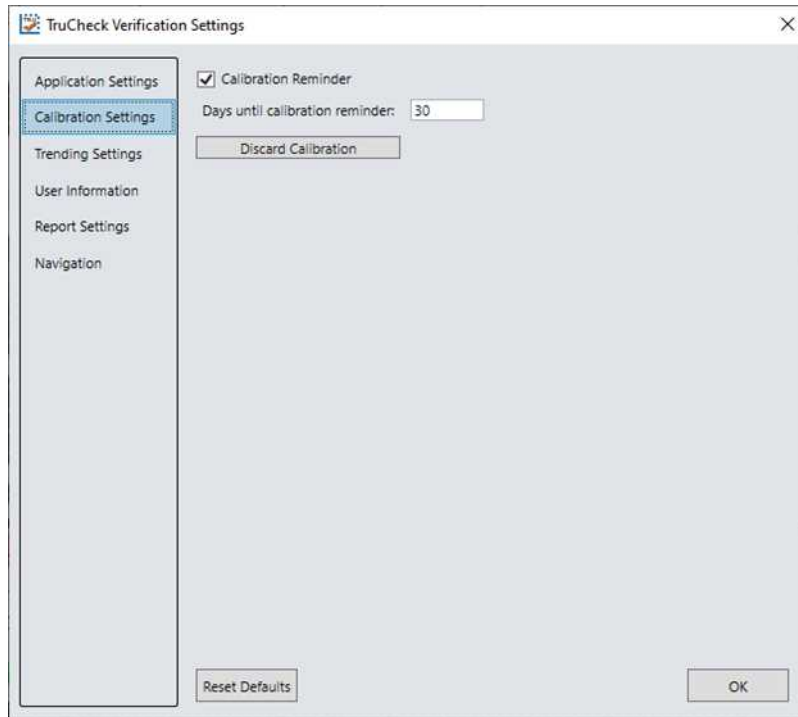







**Tip:** Click **Discard Calibration** to remove all calibration values and return the verifier to an uncalibrated state.



# User Interface

This section describes the settings and options of the TruCheck Verification window.

## Toolbar

Icon	Function
	<b>Settings:</b> Opens up the settings menu allowing changes in the Application Settings, Calibration Settings, Trending Settings, User Information, Report Settings, and Navigation menus. For more information, see <a href="#">Settings on page 38</a> .
	<b>Calibration:</b> Opens up the calibration window to calibrate the unit. For more information, see <a href="#">Calibration on page 21</a> .
	<b>Grid &amp; Modulation Circles:</b> Select <b>Grid &amp; Modulation Circles</b> to apply a grid or a modulation circle to the image after verification. Use the drop-down menu to apply a Real Grid, an Ideal Grid, or both. Select Mod Circles Filled or Mod Circles Outlined options according to your needs.
	<b>Original Image:</b> Shows the image as the imager has acquired the image before post processing.
	<b>45° illumination:</b> Enables 45° illumination. 45° four-sided illumination is used primarily for labels. 45° illumination is either not reported or reported as 45Q. If the system does not report illumination, it is assumed to be 45Q.  <b>Note:</b> This lighting option is available on both the DataMan 475V and the 475V DPM.
 	Select this icon for 30° two-sided illumination. 30° two-sided illumination can be from either the North/South or East/West. 30° two-sided illumination is useful on cylindrical surfaces. Select the sides in parallel to the axis of the cylinder. This illumination is reported as 30T.  <b>Note:</b> This lighting option is only available on DataMan 475V DPM.
	Select this icon to use one side of the 30° lighting. Use the drop down menu to select one of the four sides for 30° lighting. If you select this lighting option but you do not select any individual lighting side, the software uses top 30° lighting. The system reports one side 30° illumination as 30S.  <b>Note:</b> This lighting option is only available on DataMan 475V DPM.
	Select this icon to use four side 30° illumination. Four side 30° illumination reduces glare from some substrates, which cause poor Symbol Contrast or Modulation grading. The system reports four side 30° illumination as 30Q and is used primarily for DPM applications.  <b>Note:</b> This lighting option is only available on DataMan 475V DPM.
	Select this icon for 90° diffuse illumination. 90° diffuse illumination works well on very shiny substrates and Dot Peen Applications. 90° diffuse illumination is reported as 90.  <b>Note:</b> This lighting option is only available on DataMan 475V DPM.

# Using Your DataMan 475 Verifier

## Verifying a 2D Barcode

To verify a Data Matrix code or a QR code in the TruCheck Verification Window:

- 1. Navigate to the **Main** tab.
- 2. Click **Go Live** and center your symbol in the field of view, or press and release the trigger button to **Go Live**.

**Note:** After selecting **Go Live**, the button changes to **Verify**.

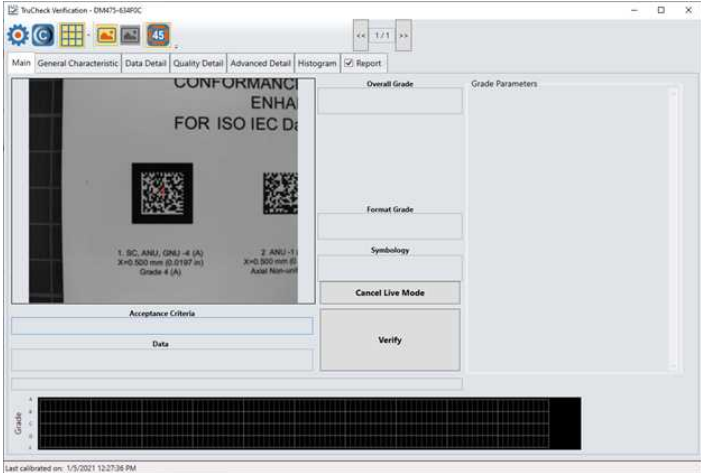

- 3. Draw a selection region around the code to be verified, if necessary.

**Note:** Make sure to draw the region around the outside perimeter of the code including quiet zones. More information on properly defining regions is explained in [Selecting Regions on page 27](#).

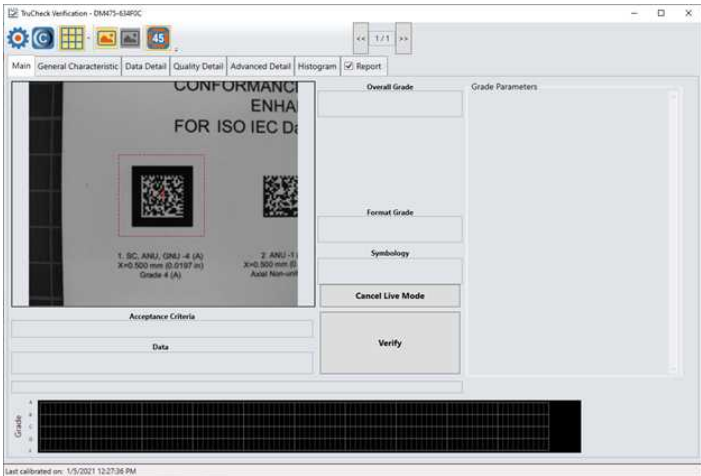

4. Click **Verify**, or press and release the trigger button on the verifier to begin verification.

**Note:** The following screenshot shows a successful 2D barcode verification. Additional details in the TruCheck window are displayed depending on grading and application standards.

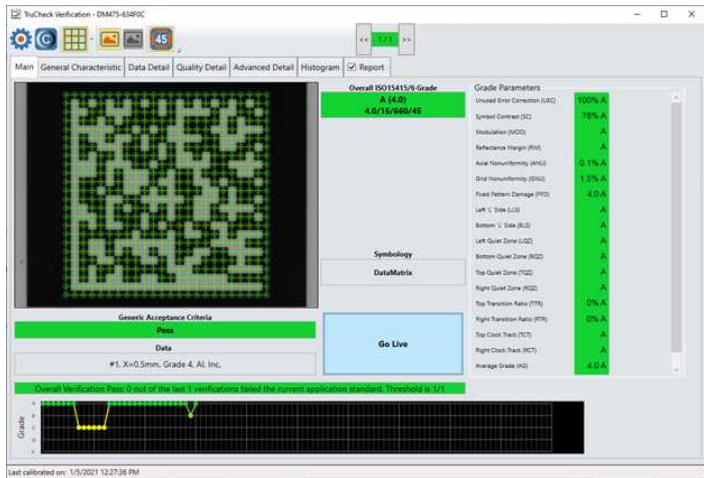

**Note:** Use the tool bar buttons and tabs on the screen for in-depth analysis of codes. For more information, see [Examining the Results on page 30](#).

## Selecting Regions

Requirements for specifying regions on the image are the following:

- Specify a small sampling area, to speed up the verification process on verifiers with large fields of view,
- Restrict a region for image brightness adjustments when grading according to AIM-DPM (ISO/IEC 29158)
- Specify a barcode for verification when more than one barcode is present in the field of view

If you do not specifying a region, the whole image is used for verification.

To specify a region, use the cursor to drag and drop.

For Data Matrix symbols and QR Codes, specify the region around the outside perimeter including quiet zones of the code to capture the entire finder pattern within the selection to properly grade the code.

When verifying a 1D symbol, select a region that includes the full width of the barcode including both quiet zones.

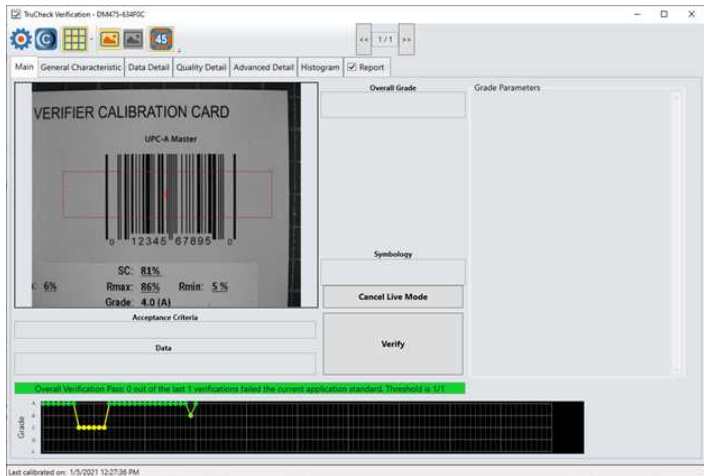

## Standards Based Grading

The Standards Based Grading option of the DM475V uses verification algorithms to produce well-defined, consistent results from the image of a code captured by a barcode reader in a real-world setup. The system utilizes Standards Based Grading if you do not use the provided LabelLite attachment.

**Note:** Standards Based Grading is a solution to produce reliable barcode verification results in situations where ISO compliance is not required, but please note that Standards Based Grading does not provide true verification results. For ISO compliant, true verification result, use the provided LabelLite attachment.

Aim for an optical setup that is as close as possible to a fully ISO compliant verifier – especially the lighting angle. The system calculates parameter values in the same way as with a verifier, so the closer the setup is to a true verifier, the closer the results are to true verification. If the lighting setup is the same, parameter values between standards based grading and verification converge. Standards Based Grading is the closest way to achieve verification results when it is not practical to conform to specific lighting angles, distances, or every ISO standard parameter.

Make sure that you calibrate the system if you want to perform Standards Based Grading. If the verifier is used without calibration, the verifier does not report all quality parameters. When you do not perform the calibration, the verifier does not report the aperture or Symbol Contrast (SC) for ISO/IEC 15415/15416 applications and Minimum Reflectance (MR) for ISO/IEC TR29158 (AIM-DPM) applications.

**Note:** In an uncalibrated state, the verifier does not report aperture value, but uses the default aperture selection: Auto 80% for 2D applications and Auto 50% for 1D applications.

## Verifications of Multiple Symbols

To enable the multiple barcode verification feature, complete the steps in DataMan Setup Tool before initiating verification in the TruCheck window.

1. Open DataMan Setup Tool.
2. To connect to the DM475 Verifier double click on the icon in the automatically generated list on the **Start up** page.

**Note:** If you have trouble connecting, refer to DataMan Setup Tool Reference manual.

3. Select **Code Details** from the **Application Steps** in Setup Tool.
4. Under the **Basic** tab, change the **Number of Codes** field to a value greater than 1 to see the expanded list of options available.

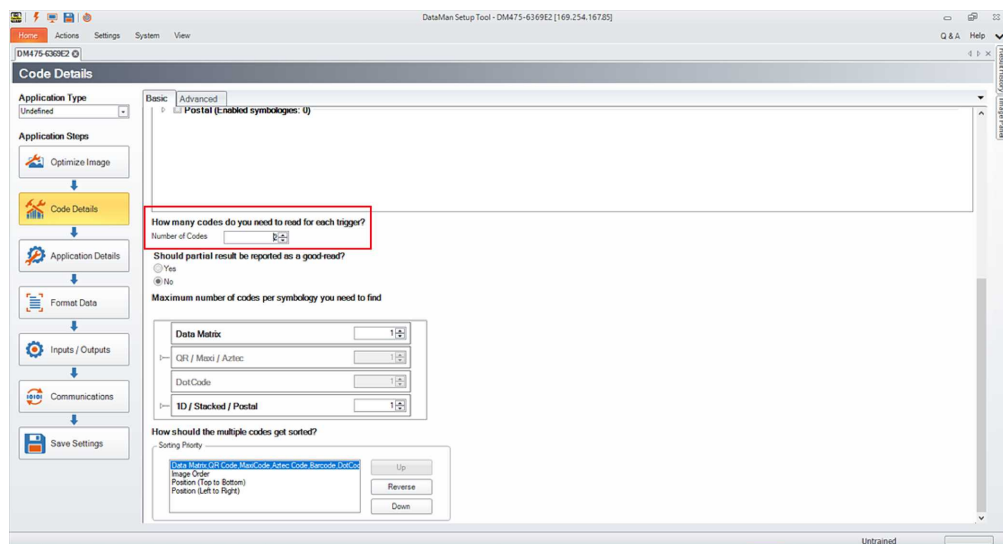

- 5. Select the **Number of Codes** to be verified during a single trigger.
- 6. For **Should partial result be reported as a good-read?** select **No**.

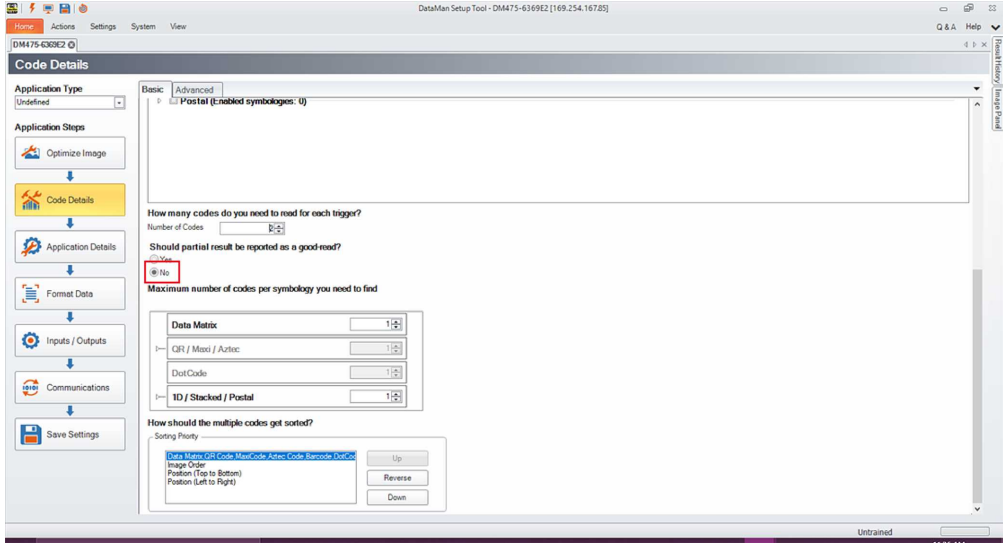

- 7. Select the quantity of each symbology type to be verified in a single trigger under **Maximum number of codes per symbology you need to find**.
- 8. Select the appropriate **Sorting Priority**.
- 9. Open the TruCheck window and initiate a verification.

For multiple verifications, select either a single region to identify all symbols for verification, or the entire field of view.

See the individual results in the tabs with the help of the arrows at the top of the TruCheck verification window, following the successful verification of multiple symbols. If all verifications pass, the box is green. If any verification fails, the box is red.



Saved Code Quality reports include an appended report containing individual result for each verified barcode.

# Examining the Results

This section details how to view and analyze the verification results.

## 1D & 2D Verification

The following chapters discuss the user interface of the TruCheck Verification. The image displays the TruCheck Verification window.

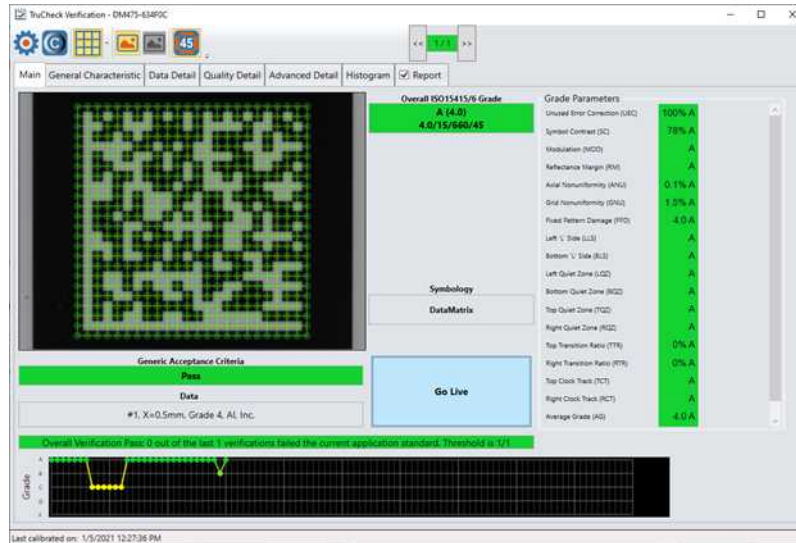

## Main Tab

The **Main** tab shows a snapshot of the verification results.

**Acceptance Criteria:** Provides a Pass or Fail grade for the barcode and is dependent on the **Application Standard** selected. For more information, see [Application Settings on page 39](#).

**Data:** Shows the decoded data.

**Overall Grade:** Shows the overall grade results for the barcode as both a letter grade (A) and numeric grade (4.0). A Formal Grade is provided in the format “Grade/Aperture/Wavelength/Lighting”.

For example, a Formal Grade of “4.0/08/660/45” is interpreted as receiving a grade of 4.0 using 8 mil aperture (0.2 mm), 660 nm wavelength, and 45° lighting.

**Format Grade:** Indicates PASS or FAIL, depending on the **Application Standard** or **Data Format Check** criteria selected. For more information, see [Application Settings on page 39](#)

**Symbology:** The name of the type of barcode (for example, *Data Matrix* or *Code 128*).

**Grade Parameters:** Provides information on the Quality Parameters grading for the barcode. For more information, see [Quality Detail Tab on page 34](#).

**Grade Trending:**



The TruCheck window shows the grade trending values for symbol verified over time. The graph at the bottom of the **Main** window shows data points associated with the overall grade for each symbol verified. The grade trending reports the data point for each Overall Grade.

In verifications where a symbol passes all quality parameters but, for another reason, fails the acceptance criteria such as data parsing error or x-dimension range, the grade is shown as an F. For example, if a symbol receives an overall grade of A (4.0) but fails for an X-dimension out of range, grade trending marks the data point as an F.

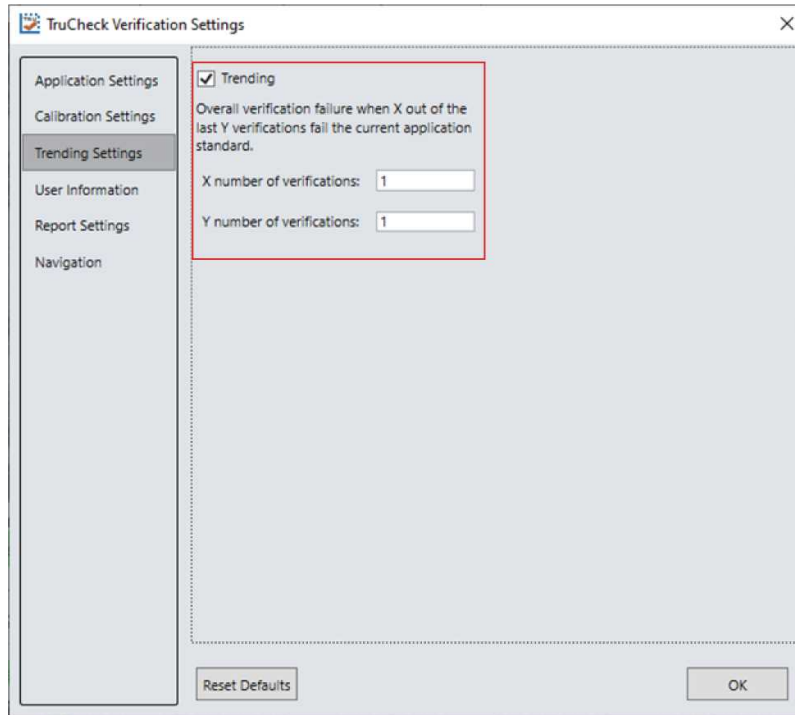

1. Enable or disable **Grade Trending** using the **Trending** checkbox in the **Trending Settings** menu.
2. Set a tolerance range for the number of verifications (x) allowed to fail out of the total number of verifications (y) specified.

If the trending point falls below the specified threshold, trending is reported as an Overall Verification Failure. The Pass Grade value set in the **Application Settings** menu determines if a symbol is a pass or fail for Grade Trending purposes. Grade Trending does not show data points for verifications that result in a NO DECODE evaluation.

**Note:** Grade Trending data points remain populated and continue to trend on the **Main** window until you disconnect the power from the verifier.

## General Characteristics Tab

The **General Characteristic** Tab shows the physical characteristics of the verified barcode.

The image shows the characteristics of a Data Matrix barcode:

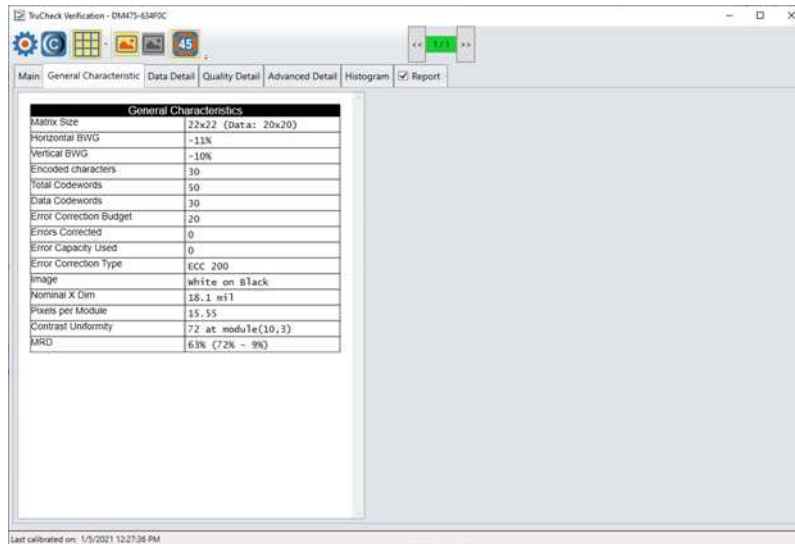

**Contrast Uniformity** verifies conformance with ISO/IEC 15426-2 as shown in the **General Characteristics** tab. Some of the contents of this screen depend on the symbology and settings on the **Report Settings** menu.

The image shows the characteristics of a 1D barcode:

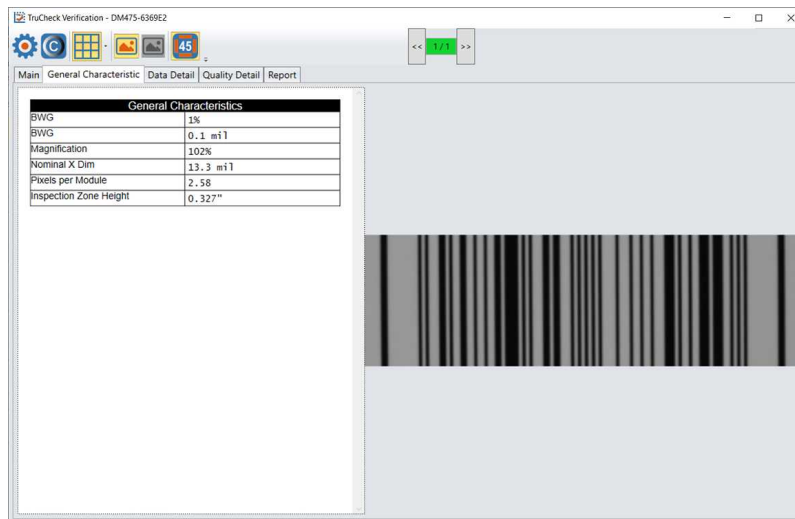

## Data Detail Tab

The **Data Detail** tab shows all of the data encoded in the symbology in various ways, and makes the understanding of the symbology easier. The verbose interpretation of the symbology is especially helpful when the data is encoded incorrectly. The level of detail depends on the symbology and the selected **Application Standards**.

The image shows the encoding information of a Data Matrix and the depiction of the symbol showing each module:

The **Data Detail** tab contains the following parameters:

Data Parameter	Content
<b>Data</b>	refers to the data decoded from the symbology in normal, printable characters.
<b>Unicode Data</b>	shows the data interpreted as Unicode characters. The characters are the same as the characters in Data section, except when the data in the symbology encodes non-latin characters, such as Kanji, using Unicode encodation.
<b>ASCII Values</b>	gives ASCII value of each decoded character. ASCII values are helpful in case an unprintable character is encoded in the symbology and you need to confirm that the character is correct. For example, by looking at the ASCII values table you can see that a <GS> in the decoded data is actually the ASCII character with decimal value of 29, and not the four characters: “less than”, G, S, “greater than”.
<b>Codewords</b> if applicable	section lists the values of the raw codewords encoded in the symbology, including the error correction codewords. An asterisk (*) denotes codewords which were decoded incorrectly and determined through error correction decoding.
<b>Encodation Analysis</b> if applicable	shows the detailed conversion of raw codewords into decoded ASCII values using the encodation and compression methods defined for the symbology. For example, in Data Matrix an encodation method known as C40. The C40 method encodes 3 ASCII characters in only two codewords. Similarly, PDF417 and other 2D symbologies have various methods of encoding different types of data (such as numeric only data) in efficient ways. The encodation analysis table can show you the process of this encodation or decoding.

## Modulation table legend

To help interpret the color coding associated with the modulation table on the Data Detail tab, the software provides a legend. The letter grade associated with each modulation value range is shown on the left. The colors are distinguished based on whether the module is light (white) or dark (black).

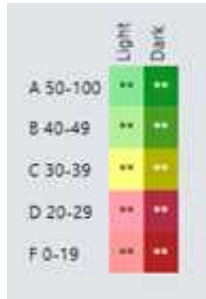

When a data checking failure occurs, a message indicates the cause of the failure.

For example, if a check digit is incorrect, a message indicates the expected check digit value. When the verification detects an error, the application stops the parsing and generates a report.

When you hover over the codewords in the Data Matrix **Codeword table**, the Code module display highlights modules constituting the 8-bit codeword are highlighted within the image to show where the data is encoded within a Data Matrix symbol.

The screenshot displays the 'Quality Detail' tab of the TruCheck Verification software. The interface includes a navigation menu at the top with options: Main, General Characteristic, Data Detail, Quality Detail, Advanced Detail, Histogram, and Report. The 'Quality Detail' tab is active, showing a summary of the data and a detailed modulation grid.

**Data Summary:**

- Data:** #1, X=0.5mm, Grade 4, AI, Inc.
- Unicode Data:** #1, X=0.5mm, Grade 4, AI, Inc.
- ASCII Values:** 035 049 044 032 088 061 048 046 051 109 109 044 032 071 114 097 100 101 032 052 044 032 065 073 044 032 073 110 099 046
- Codewords:** 240 143 027 032 099 220 031 239 008 082 166 146 069 059 048 167 109 020 254 053 045 033 066 074 045 033 074 111 100 047 073 237 225 008 179 041 084 135 217 150 105 164 102 236 146 224 215 052 119 075
- Encoding Analysis:**

Codeword	Mode	Result
240	ASCII	SWITCH TO EDIFAC MODE
143, 027, 032	EDIFAC	#1,
099, 220, 031	EDIFAC	X=0
239	ASCII	SWITCH TO TEXT MODE
008, 082	Text	.S

The modulation grid on the right shows a 22x22 grid of modules. The grid is color-coded according to the modulation table legend, with most modules being light green (Grade A) and some being dark green (Grade A) or light yellow (Grade B). The grid is used to visualize the data encoding within the Data Matrix symbol.

## Quality Detail Tab

The **Quality Detail** tab shows the measured quality parameters and lists the formal grade. Different symbologies and quality grading standards display pertinent data on the **Quality Detail** tab.

Characteristics of a 2D Data Matrix code graded according to ISO 15415:

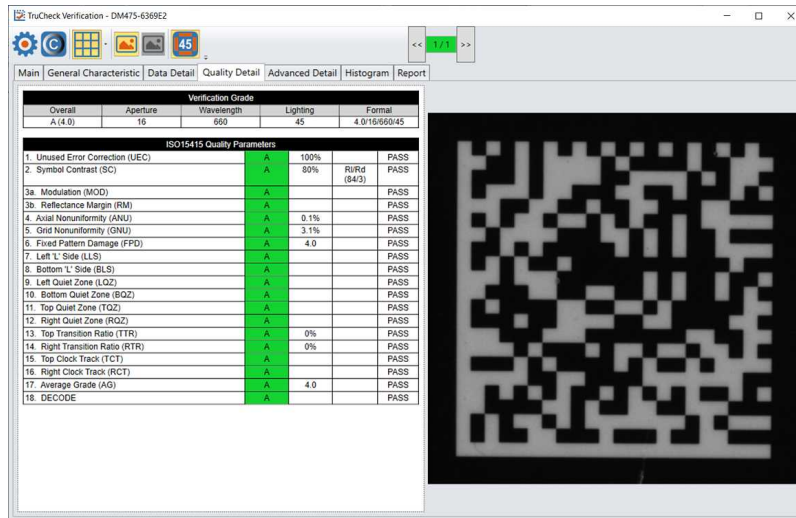

Characteristics of a 1D UPC-A symbol graded according to ISO 15416:

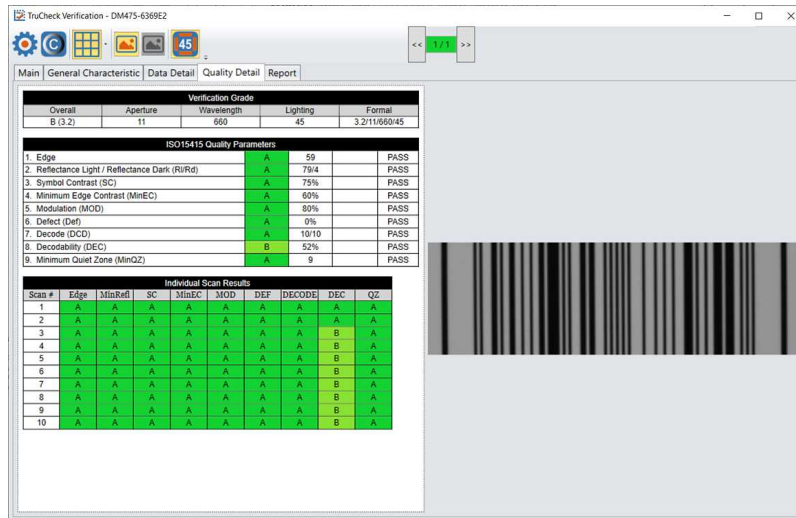

For more information on grading standards, see [Grading Standards and their Parameters on page 1](#).

## Advanced Detail Tab

The **Advanced Detail** tab shows in-depth information on the verified code. Depending on the type of the 1-D or 2-D code that was verified, the information on the **Advanced Detail** tab may vary.

The example shows the modulation values from a Data Matrix symbol:

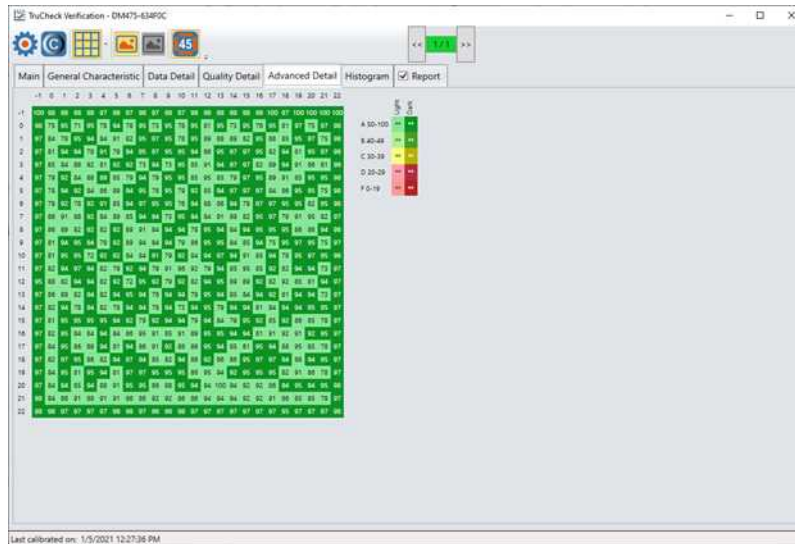

For more information on modulation calculation, see [Grading Standards and their Parameters on page 1](#).

## Histogram Tab

The **Histogram** tab shows the analysis of the reflectivity of each cell and associated grade.

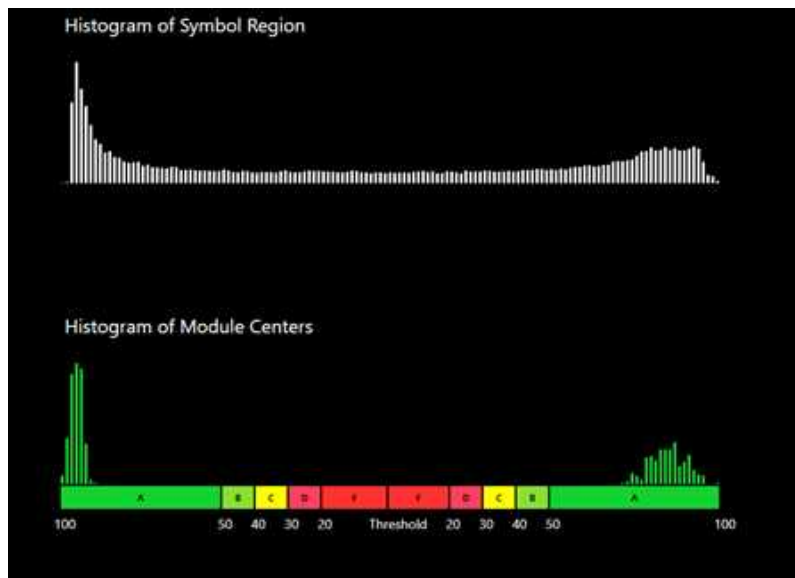

The horizontal axis on the **Histogram** represents the brightness level with the dark elements on the left side and the bright elements on the right side. As the element's brightness increases, the **Histogram** displays the element farther to the right of the **Histogram**. The height of each bar represents the number of elements with the same brightness associated with the elements' positions on the horizontal axis.

The top graph of the **Histogram** represents the brightness of all the pixels in the code region. The bottom graph of the **Histogram** represents the sampled module locations in the symbol.

The horizontal axis contains markers showing the global threshold, and all modulation levels are separated for both dark and light elements.

**Note:** When grading according to ISO/IEC TR29158 (AIM-DPM), the **Histogram** gets different labeling. The location of the 0% and 100% labels on the horizontal axis are at the means of the dark and light lobes of the Histogram and there is no C level because the DPM grading method uses only A, B, D and F levels for Cell Modulation.

## Report Tab

To enable the Code Quality report to become available in the **Report** tab, enable the **Generate Code Quality reports** in the **Results History** panel of Setup Tool.

**Note:** Minimize TruCheck window and click Setup Tool window on the taskbar.

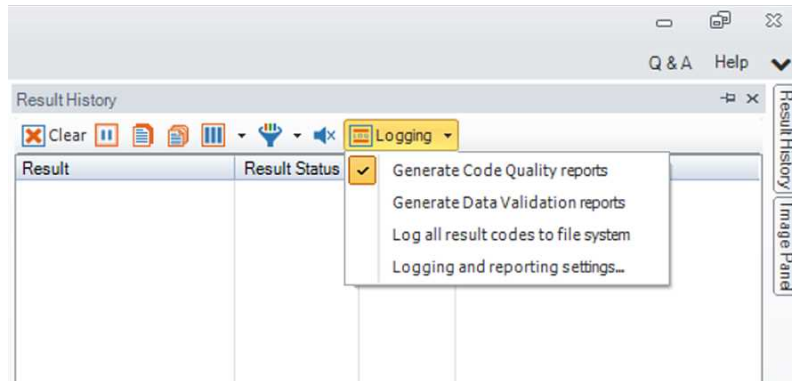

**Note:** The Code Quality report contains the results specific to verification when the verification feature key is installed and verification is enabled in the Setup Tool window. The Code Quality report contains the results and separate from the previous Code Quality results that Process Control Metrics (PCM) generate.

When you enable the **Code Quality report**, the **Report** tab becomes available in the **TruCheck Verification** window showing full verification results formatted into a printable report.

Alternatively, you can check the the checkbox on the **Report** tab in the **TruCheck Verification** window.



# Settings

This section describes the settings and the options available in the **TruCheck Verification** window.

## The Settings Menu

To access **Settings**, select **Settings** in the upper left corner of the **TruCheck Verification** window.

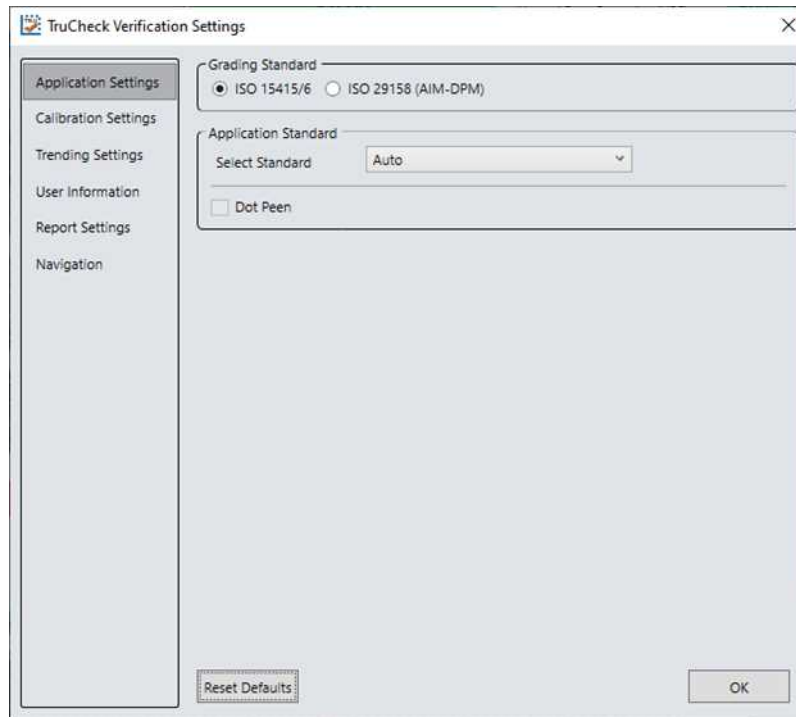

# Application Settings

The content of the **Application Settings** window depends on which **Application Standard** you select. The application standard setting automatically sets many of the parameters.

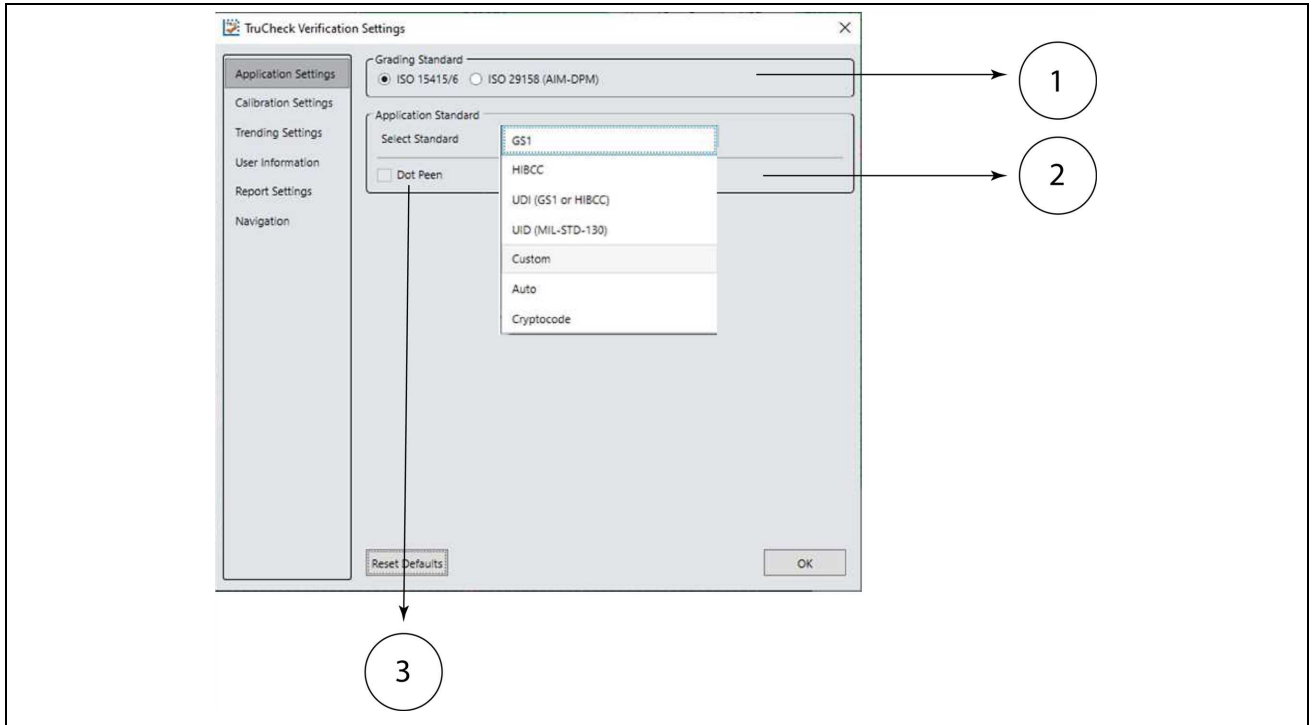

Number	Element	Description
1	Grading Standard	For any <b>Application Standard</b> selected, you need to select a <b>Grading standard</b> , depending on your application. For more information, see <a href="#">Grading Standards on page 49</a> . Available options are: <ul style="list-style-type: none"> <li>• ISO/IEC 15416 (ANSI x3.182)</li> <li>• ISO/IEC 15415</li> <li>• ISO 29158 (AIM DPM) 2006</li> <li>• ISO 18004</li> <li>• Traditional (Non-Graded)</li> </ul>
2	Application Standard	You can select pre-defined and custom application standards. For more information, see <a href="#">Application Standards Settings on page 41</a> <ul style="list-style-type: none"> <li>• Selecting a pre-defined application standard ensures that the DM475 Verifier uses the appropriate grading parameters for your application.</li> <li>• <b>Custom</b> application standard allows you to customize all adjustable verification and process parameters.</li> </ul>

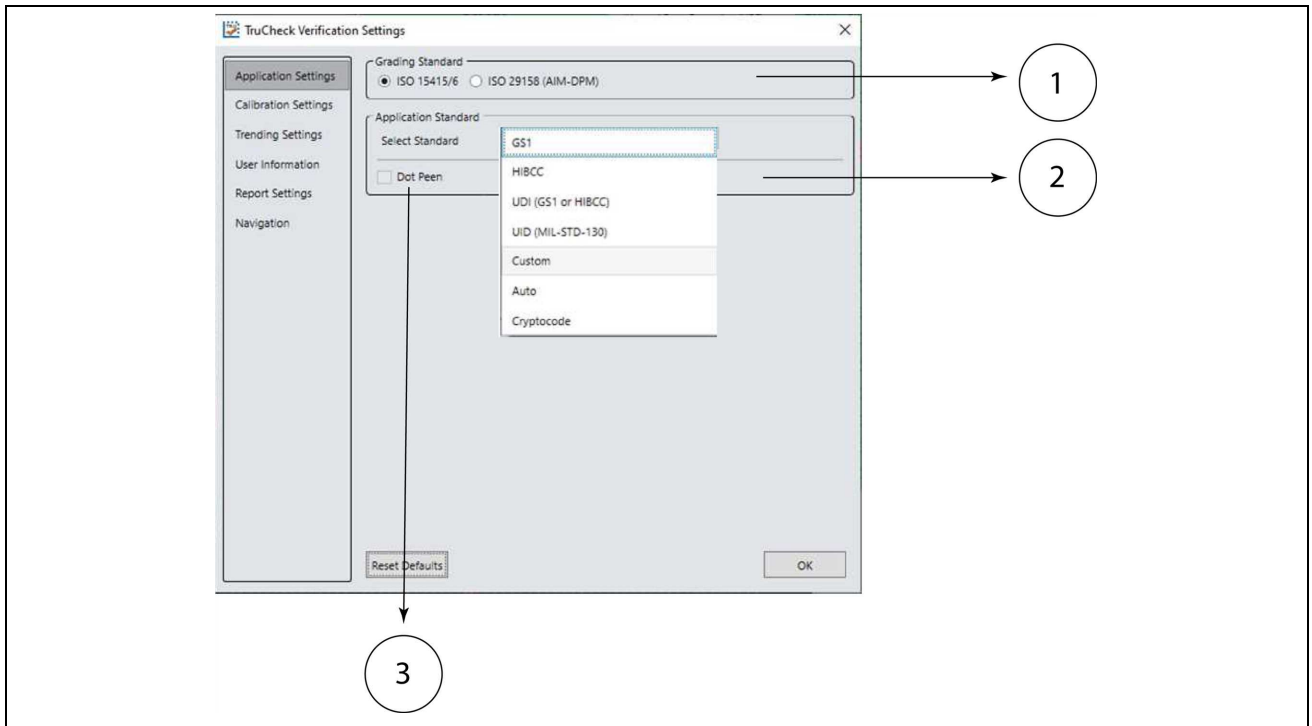

Number	Element	Description
3	Dot Peen	<p>The <b>Dot Peen</b> option helps you connect dots in case of codes created through a process where dots are peened onto a metal surface. Select <b>Dot Peen</b> to use the AIM-DPM Stick algorithm to connect dots. For more information, see in <a href="#">Dot Peen on page 40</a>.</p> <p>Available options are:</p> <ul style="list-style-type: none"> <li>• Min X-Dimension (mils)</li> <li>• Max X-Dimension (mils)</li> <li>• Pass Grade</li> </ul>

The **Reset Defaults** button resets the **Application Settings** menu to the default settings (Auto).

After clicking **Reset Defaults**, you must calibrate the verifier before using it. For more information, see [Calibration on page 21](#).

## Dot Peen

Use the dot peen option for codes created through a process where dots are peened onto a metal surface. Select **Dot Peen** to use the AIM-DPM Stick algorithm to connect dots.

**Note:** You can select **Dot Peen** only if you select ISO 29158 (AIM-DPM) as **Grading Standard**. For more information, see [Grading Standards on page 49](#).

### Min X-Dimension (mils)

Set the minimum x-dimension value. It is not possible to set the value lower than 1 mil. Any code that falls below the minimum x-dimension receives a grade of Fail (X-Dimension out of Range). If you do not specify a minimum x-dimension, the application default is 5 mils.

## Max X-Dimension (mils)

Set the highest possible x-dimension value. The highest value that can be set is 100 mils. Any code that is above the maximum x-dimension receives a grade of Fail (X-Dimension out of Range). If you do not specify a maximum x-dimension, the application defaults to 30 mils.

## Pass Grade

Select a minimum passing grade based on a letter and a number which is C >1.5. Any verified code that does not receive an Overall Grade above the Pass Grade minimum receives a grade of Fail for Pass Grade on the User Interface and in the Report.

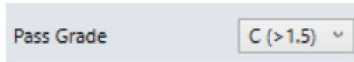

## Application Standards Settings

Application Standards configure the verifier to grade according to pre-defined rules established by an industry standards body or other industry requirements.

Select one of the options provided in the drop down box to specify the application standard.

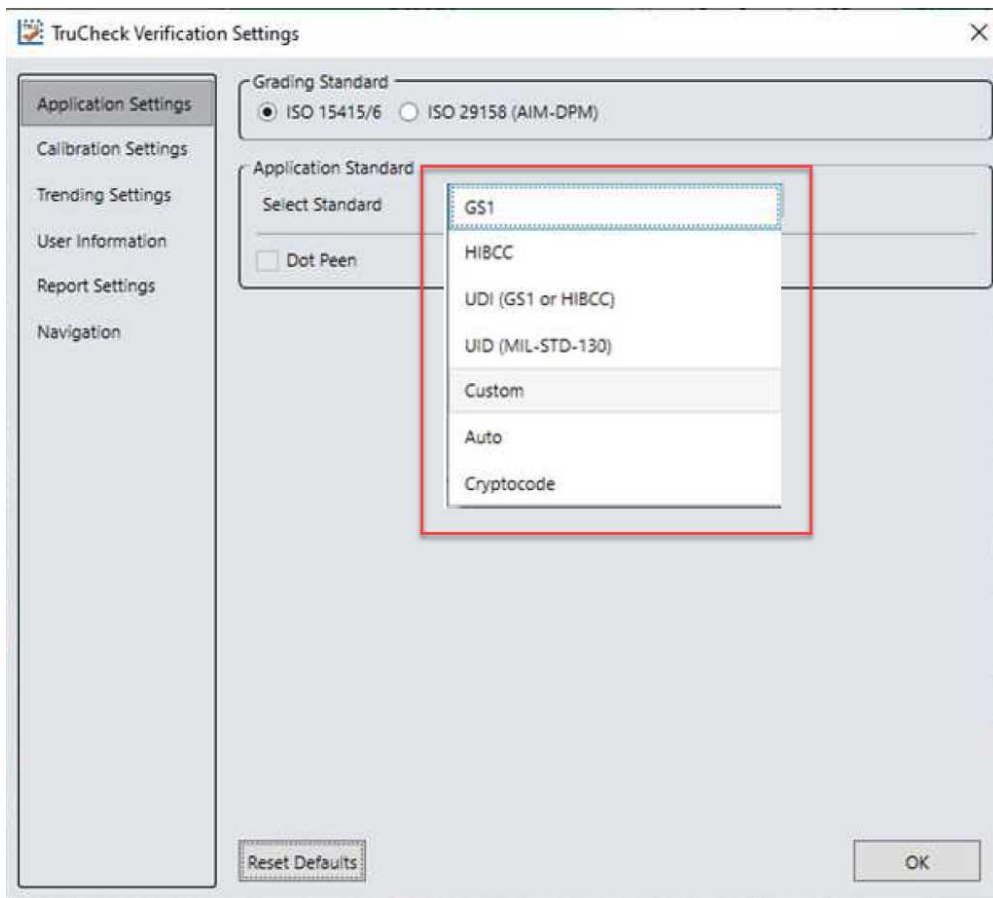

The available options are:

- Pre-defined
  - GS1
  - HIBCC
  - UDI (GS1 or HIBCC)
  - UID (MIL-STD-130)
  - Auto
  - Cryptocode
- Custom

## GS1

GS1 application standard follows GS1 General Specification guidelines in code verification. GS1 General Specification Tables 1-11 describe several categories of applications. Select from the tables to specify the application category for your codes.

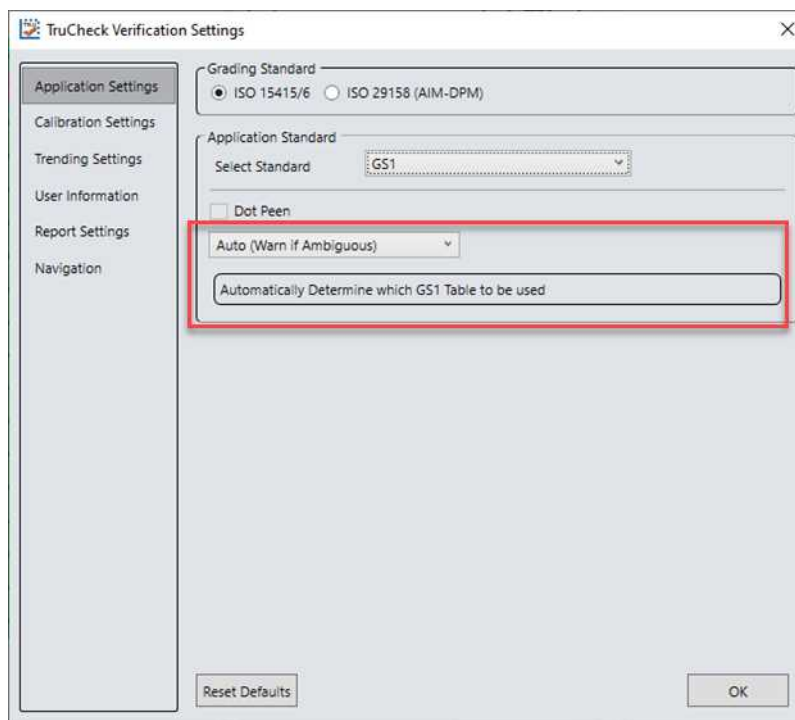

If you select Auto (Warn if Ambiguous), the most applicable General Specification Table is automatically selected for you.



**Note:** The DM475 Verifier uses the X-dimension of the decoded symbol to deduce which table applies. If the X-dimension is outside the range allowed in your application, results will be incorrect. To make sure that the verifier checks all the correct requirements for your application, select the Table in the GS1 General Specifications that applies to your application.

The selected GS1 table is available in the **Notes** section of the report. For more information on the tables used for analysis, see [GS1 General Specifications Standard](#).

Select **Dot Peen**, if applicable.

## UID (MIL-STD-130)

The UID (MIL-STD-130) application standard reports the quality standard according to the MIL-STD 130 specifying UID marks Construct 1 and Construct 2 that use data structure and code grade for verification. The MIL-STD 130 spells out acceptable grades and requirements for data format.

Specify either the ISO 15415 grading or the ISO 29158 (AIM-DPM) grading for the MIL-STD-130 UID Application Standard. For more information, see [Grading Standards and their Parameters on page 1](#).

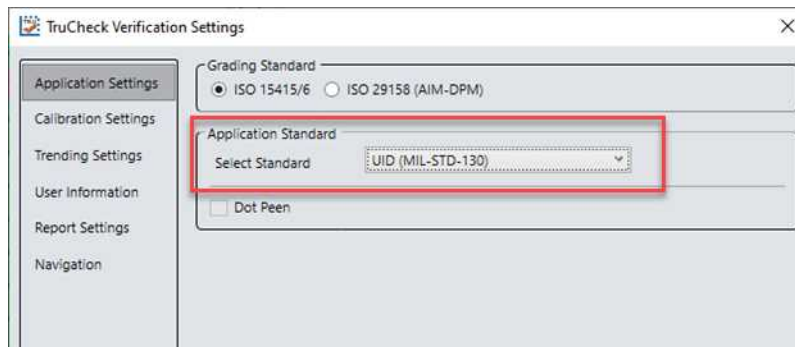

Select **Dot Peen**, if applicable.

## UDI (GS1 or HIBCC)

The UDI (GS1 or HIBCC) application standard checks symbols that meet UDI requirements using either GS1 or HIBCC guidelines.

Specify the ISO 15415 grading or the ISO 29158 grading. For more information, see [Grading Standards and their Parameters on page 1](#).

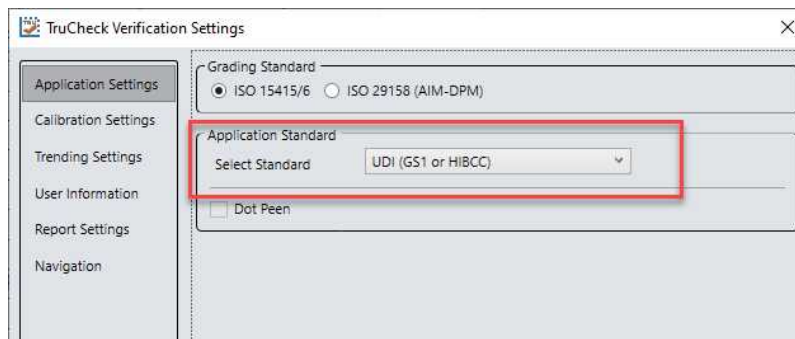

UDI compliance requires data content that varies depending on the medical device the data is applicable to, so the DM475V only validates the format, not the content. Validating format is automatic and in accordance with formatting rules of the chosen grading standard guidelines.

Select **Dot Peen**, if applicable.

## Auto

Apply the **Auto** application standard option to allow the verifier to select the correct application standard based on the format of the data encoded in the symbology. If the verifier detects GS1, HIBCC or MIL-STD 130 standards within a symbology during verification, the verifier uses the correct application standard, respectively.

**Note:** Select the **Custom** application standard instead of **Auto** if the symbology contains data structure that the grading of the automatic standards do not apply.

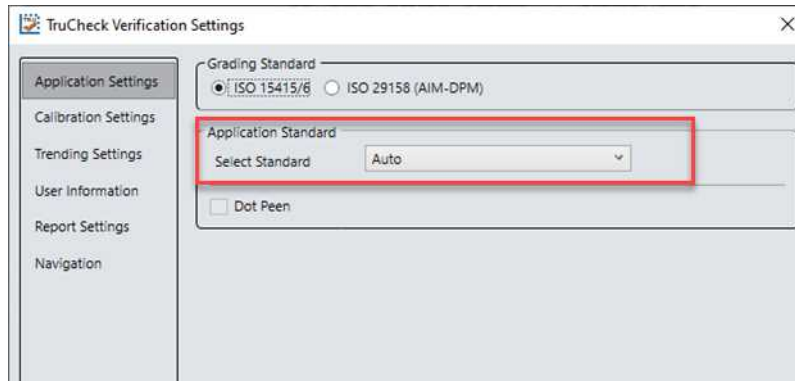

## Cryptocode

The **Cryptocode** application standard checks symbols that meet Russian Cryptocode standard or other Cryptocode applications.

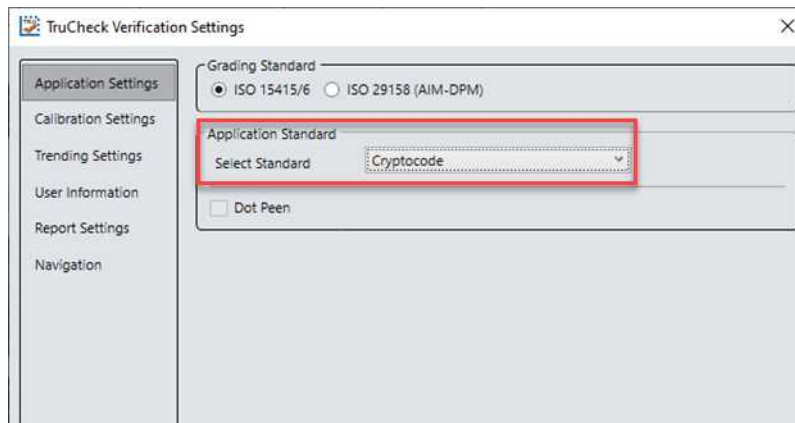

## Custom

Apply the **Custom** standard option when you are grading a code that is not expected to adhere to any pre-defined industry conformance standard, and so it can be customized with specific settings for:

- Grading Standard: ISO 15415 or ISO 29158, for more information, see [Grading Standards and their Parameters on page 1](#).
- Minimum and Maximum X-dimension
- Overall Pass Grade
- Data Format Check
- Aperture Size

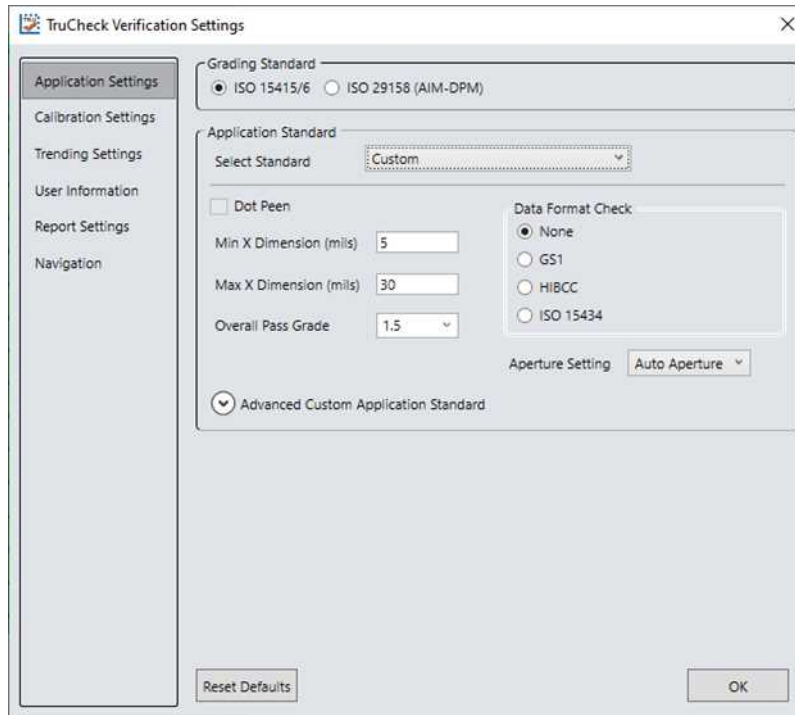

The **Custom** application setting options include **Advanced Custom Application Standard** option for the customization of grading by each individual quality parameter. The **Advanced Custom Application Standard** options allow you to select individual pass thresholds for each Quality Parameter for 1D and 2D symbologies. If a pass grade is selected for any of the Quality Parameters, the Overall Pass Grade, the Acceptance Criteria evaluation of Pass or Fail is overridden for that parameter.

**Note:** For example: if you set the Overall Pass Grade to 1.5 and the Grid Non-Uniformity value individually to 3.5, a symbol graded with a GNU value below 3.5 will be given an Acceptance Criteria of Fail (Quality) even if the Overall Grade is greater than 1.5. If you set all Advanced Custom options to N/A, the verification does not apply any advanced custom application standard settings and will evaluate the Quality Parameters according to the value in the Overall Pass Grade only.

Utilize the **Advanced Custom Application Standard** settings only in specific cases by users with a strong understanding of their application. Changing the Advanced Custom Application Standards will directly impact the Overall Grade during verification.

In addition, the **Advanced Custom Application Standard** menu provides options to choose between ISO 18004 Quiet Zone (QZ) Requirement of a 4-module quiet zone or the ISO 16480 QZ Requirement of a 1-module quiet zone.

**Advanced Custom Application Standard** gives users the option to select between the ISO 29158:2011 standard or the ISO 29158:2020 standard.

At the bottom of the menu, a button is provided to Clear Advanced Parameters and reset all values back to N/A.

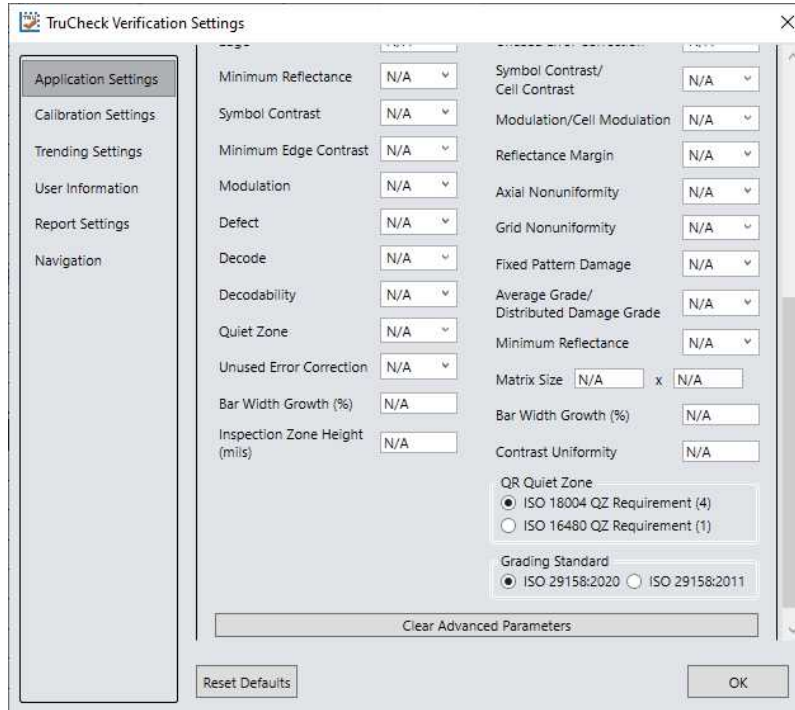
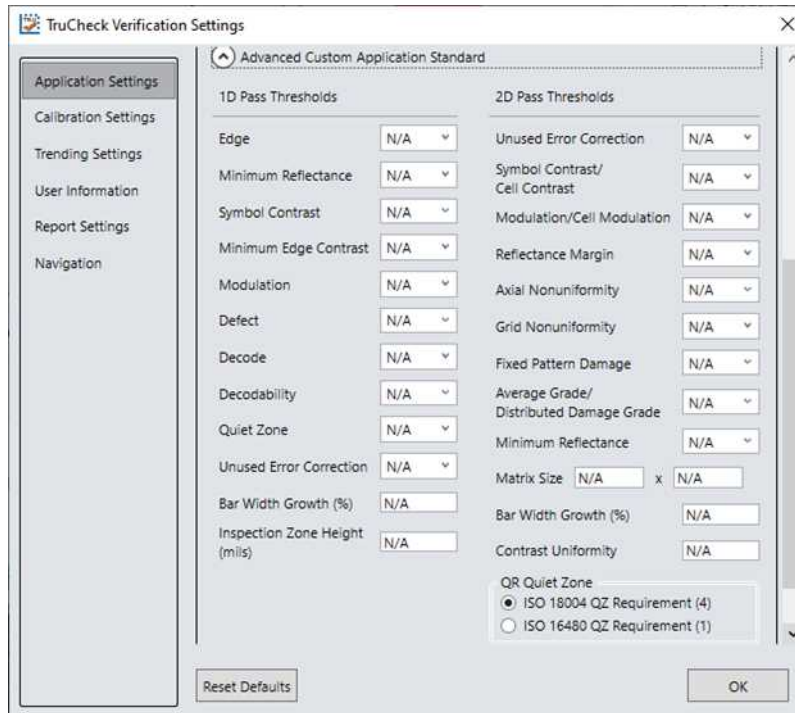

## Data Format Check

You can apply a specific **Data Format Check** criteria to the data content of the code or leave the option as **None**. If you apply a specific Data Format Check, a **Data Format Check** grading box becomes available on the main screen of the User Interface to show the Pass or Fail grade. The report contains a Data Format Check table showing detailed parsing information.

- **GS1**: The GS1 option checks the format of the data against GS1 formatting rules. GS1 codes generally begin with a Function 1 <F1> character.

- **HIBCC:** The HIBCC option checks the format of the data against HIBCC formatting rules. HIBCC codes generally begin with a + character.
- **ISO 15434:** The ISO 15434 option checks data for many industry standards which encode information using ISO/IEC 15434 data structures. ISO 15434 codes generally begin with the sequence ]]><RS>nn<GS> where nn are two digits which are typically 05, 06 or 12. MIL-STD-130 and some shipping container applications use this formatting style.

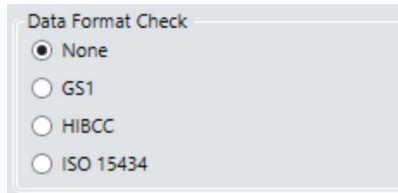

### Aperture Setting

Aperture setting refers to a synthetic aperture as opposed to an optical aperture. Aperture is a circular region imposed on the pixels which comprise the individual modules making up the code. This process is mandated by the ISO 15415 and 15416 standards. Set the aperture settings when choosing Generic Application Standards.

Aperture Size setting is compatible with ISO/IEC 15415 only. AIM-DPM grading includes a blurred reference image, similar to ISO 15415. The AIM-DPM grading method dictates the aperture size to be either 50% or 80% of the symbol X-dimension.

**Note:** Aperture setting must match the Application Standard.

Larger aperture sizes reduce:

- Sensitivity to printing defects
- Ability to resolve small elements in a code

The size of the aperture is limited by the X-dimension of your symbols, or the X-dimension of your symbols is limited by the size of your aperture. Chose aperture size in application specification, quality specification or both. If you do not know the correct aperture size to select, choose **Auto** and the verifier uses guidelines in ISO 15415 to choose an aperture size based on the X-dimension of the code.

Always specify an aperture size for the Generic Application Standard when using ISO/IEC 15415 Grading Standard.

In the drop down menu, select:

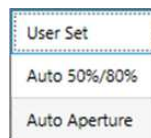

### User Set

The application allows you to specify the **Aperture Setting**. If you select **User Set**, an additional drop down menu shows up for you to select the aperture.

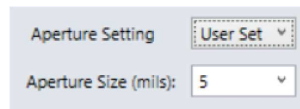

### Auto 50% or 80%

The application automatically sets an aperture size based on 50% of the X-dimension for 1D symbologies and 80% of the X-dimension for 2D symbologies.



## Auto Aperture

This chapter describes available automatic aperture settings.

### Auto Aperture for 1D Barcodes

The application automatically sets an aperture size based on the X-dimension in accordance with the suggestion in ISO/IEC 15416. For the Generic Application Standard, the following table applies for most symbologies:

X-Dimension	Aperture
$\leq 7.0$ mil	03 (3 mil)
$7.1 \text{ mil} < x \leq 13$ mil	05 (5 mil)
$13 \text{ mil} < x \leq 25$ mil	10 (10 mil)
$> 25$ mil	20 (20 mil)
For UPC/EAN, regardless of X-dimension or magnification	06 (6 mil)

You can override these rules by determining a specific aperture directly for any application that requires a specified aperture. An application specification (such as GS1 Gen Spec, or MIL-STD 129) specifies an aperture value which can be different than what the rules in the table would yield.

### Auto Aperture for 2D Barcodes

The application automatically sets an aperture size based on the X-dimension in accordance with the suggestion in ISO/IEC 15415. For the Generic Application Standard, the following table applies for most symbologies.



X-Dimension	Aperture
$\leq 6$ mil	02 (2 mil)
$6 \text{ mil} < x \leq 7.5$ mil	03 (3 mil)
$7.5 \text{ mil} < x \leq 10$ mil	05 (5 mil)
$10 \text{ mil} < x \leq 20$ mil	08 (8 mil)
$20 \text{ mil} < x \leq 30$ mil	16 (16 mil)
$\geq 30$ mil	20 (20 mil)

**Note:** AIM-DPM grading (ISO/IEC TR 29158) always selects an aperture automatically based on the X- Dimension of the decoded symbol, which overrides the above rules. These rules apply to ISO/IEC 15415 grading if **Auto Aperture** is selected.

## Grading Standards

For any **Application Standard** selected, you need to select either **ISO/IEC 15415/6**, or **ISO/IEC 29158 (AIM DPM)** grading standard depending on your application.

- 1D barcodes use **ISO/IEC 15416**.
- 2D barcodes printed on a label use **ISO/IEC 15415**.
- 2D DPM barcodes use **ISO/IEC TR 29158**, also known as **AIM DPM**.

Barcode Type	Marked substrate	ISO Standard
1D (Linear) 	Label	ISO/IEC 15416
2D 	Label	ISO/IEC 15415
	Direct Part Mark (DPM)	ISO/IEC TR 29158 (also called AIM DPM)

For more information, visit [support.cognex.com](http://support.cognex.com), and navigate to Resources > Introduction to Barcode Verification.

## ISO/IEC 15416 (ANSI x3.182) Grading Parameters

The 1D ISO/IEC standard is based on the following workflow:





- 10 individual scan lines are created throughout the height of a code.
- Each scan line is graded against the nine quality parameters. The lowest graded quality parameter for that line becomes the line grade.
- the software averages the ten scan lines to generate a formal overall grade for the barcode.

The software grades scan lines in phases.

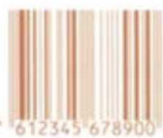
In the first phase, the scan line has to pass minimum reflectance, decode, or minimum edge contrast. If the scan line does not pass these parameters, the scan line automatically receives an “F” grade.

If all three pass, the software grades symbol contrast, modulation, defects, and decodability parameters, on a scale of A to F. The lowest parameter grade value becomes the overall grade for that scan line.

Quality parameters for 1D codes	Description	Possible solution
Edge Count (EDGE)	Pass or fail parameter that is counting the number of edges in the code.	<ul style="list-style-type: none"> <li>• A no decode could mean that the barcode does not have the proper edge count, it could be incomplete.</li> <li>• The bar space edges are not crossing the global threshold.</li> <li>• Try a smaller aperture size to see if the code can decode.</li> <li>• Double check that the code is not inverted in color.</li> </ul>
Minimum Reflectance (RI/Rd) 	Graded as A or F, the reflectance value for at least one bar must be less than half the highest reflectance value for a space.	<ul style="list-style-type: none"> <li>• To improve your minimum reflectance grade, the bars need to be darker or less reflective and the substrate or spaces need to be brighter or more reflective.</li> </ul>

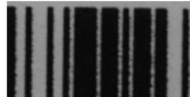

Quality parameters for 1D codes	Description	Possible solution
Symbol Contrast (SC) 	A graded value that measures the difference between the maximum reflectivity in the lightest space and the minimum reflectivity in the darkest bar.	<ul style="list-style-type: none"> <li>To improve contrast, make the bars darker and the spaces lighter or less shiny.</li> </ul>
Minimum Edge Contrast (MinEC)	A pass or fail parameter checking the level of contrast between adjacent spaces and bars is at least 15%.	<ul style="list-style-type: none"> <li>Try using a lighter substrate and darker ink or increasing the x-dimension.</li> <li>Be sure to use an appropriate aperture based on the application specification.</li> </ul>
Modulation (MOD) 	The minimum edge contrast as a fraction of overall symbol contrast, that is, MinEC divided by SC.	<ul style="list-style-type: none"> <li>Try making narrow spaces slightly wider than narrow bars this may increase the modulation grade (that is, bar width reduction).</li> <li>Alternatively, try using a smaller aperture.</li> </ul>
Decode (DCD) 	A pass or fail parameter looking to see if the code can be decoded using the standard reference decode algorithm with the selected aperture.	<ul style="list-style-type: none"> <li>Try using less ink or a different kind of ink.</li> <li>Change paper or substrate.</li> <li>Adjust artwork to accommodate known growth.</li> <li>Clean print head.</li> <li>Reduce thermal or laser heat.</li> </ul>
Defects (Def) 	A graded value that refers to a spot in a space or a void in a bar. The formula for defect is element reflectance non uniformity max divided by symbol contrast.	<ul style="list-style-type: none"> <li>Defects can be caused by dirty print heads, fusers, improper media match, low heat on thermal printers, worn printer plates, or texture of the material that the code is marked on.</li> <li>Make sure the proper aperture size is selected according to the application spec.</li> </ul>
Decodability (DEC) 	A measure of how closely the element widths match their nominal sizes and are identified with margin-for-error by the reference decode algorithm.	<ul style="list-style-type: none"> <li>To improve decodability, ensure element widths are correct.</li> <li>Barcode generation software must account for printer resolution (dots-per-inch or dots-per-mm). The printed x-dimension must be an integer multiple of the printer's raster pitch.</li> </ul>
Quiet Zone (MinQZ)	Checks that there is enough open space to the left and the right of the barcode.	<ul style="list-style-type: none"> <li>Double check artwork.</li> <li>Change placement of barcode.</li> <li>Increase label size.</li> </ul>

## ISO/IEC 15415 Grading Parameters

The 2D barcodes are graded against eight different parameters. The grading process begins with a pass/fail test. The lowest individual grade becomes the overall grade for the code. If the software can decode the code, the code passes the first test. If the software cannot decode the code, the software automatically assigns an "F" grade to the code. The parameter list:

- Symbol contrast (SC)
- Modulation (MOD)
- Reflectance margin (RM)
- Fixed pattern damage (FPD)
- Axial non-uniformity (ANU)
- Grid non-uniformity (GNU)
- Unused error correction (UEC)

The software decodes a code, then grades it for symbol contrast, modulation, reflectance margin, fixed pattern damage, axial non-uniformity, grid non-uniformity, and unused error correction.

Quality parameters for 2D codes	Description	Possible solutions
Unused Error Correction (UEC)	This is the percentage of error correction capability that is available for further incorrect modules.	<ul style="list-style-type: none"> <li>• Modify artwork by changing the module colors that are failing to the opposite color.</li> <li>• Check for physical damage to the code .</li> <li>• Look for bar width growth or print growth.</li> </ul>
Symbol contrast (SC)  	The difference in reflectivity between the brightest module and the darkest module.	<ul style="list-style-type: none"> <li>• Change the paper type.</li> <li>• Change ink color or amount.</li> <li>• Add a light-colored background behind the code.</li> <li>• Change the lighting angle.</li> </ul>
Modulation and Reflectance Margin (MOD) and (RM)  	This is a grade based on the amount of variability in reflectivity of the modules. A multi-step process is used to get the modulation grade. MOD and RM are often the same, differing only when some modules are determined to be the wrong color and error correction is used.	<ul style="list-style-type: none"> <li>• Reduce BWG by adjusting the amount of ink used.</li> <li>• Change the speed or temperature of the marking process.</li> <li>• Adjust the scale of the artwork.</li> <li>• Look for defects in the print.</li> <li>• Is there show through with the paper choice?</li> </ul>

Quality parameters for 2D codes	Description	Possible solutions
Decode (DEC)	<p>Report whether the 2D Symbol was decoded in accordance with the reference decode algorithm with the specified aperture.</p> <p><b>Note:</b> Note that when Auto Aperture or Auto 80% is selected for Aperture, it is possible for decoded results to be reported but for a failure to occur when decoding using the selected aperture.</p> <p><b>i</b> In this case, the DECODE grade will be F and a message will be reported in the grade section of the report.</p>	<ul style="list-style-type: none"> <li>• Are you using the correct aperture?</li> <li>• Are you using the right ISO Standard?</li> <li>• Are you using the right lighting angle?</li> <li>• Is the symbology enabled?</li> <li>• Is the symbol “mirrored”?</li> <li>• Is the camera in focus?</li> <li>• Is the code in the center of the FOV?</li> <li>• Do the cell sizes look proportionate to one another?</li> <li>• Are the edges of the cells crisp?</li> <li>• Are all the components of the finder pattern present?</li> <li>• Is the inkjet nozzle blocked?</li> <li>• Is the thermal element faulty?</li> </ul>
Fixed pattern damage (FPD)	<p>Overall grade for all the fixed pattern components.</p> <p>This grade is equal to the lowest grade of the finder pattern components.</p>	<ul style="list-style-type: none"> <li>• Issues with printer nozzle, needle, laser, or thermal element.</li> <li>• Physical damage to the code.</li> <li>• Are there gaps in the L, or dirt in the quiet zone?</li> </ul>
Axial Non-Uniformity (ANU)	<p>Tests for uneven scaling of the symbol, which would make readability more difficult at some non- normal viewing angles.</p> <p>In other words, a measure of the overall aspect ratio of the symbol.</p>	<p>Can be caused by:</p> <ul style="list-style-type: none"> <li>• Improper printing.</li> <li>• Marking speed or speed mismatch.</li> <li>• Printing software errors.</li> </ul>

Quality parameters for 2D codes	Description	Possible solutions
Grid Non-Uniformity (GNU) 	Measures and grades the largest vector deviation for the grid intersections from their ideal calculated position. In other words, when module grid alignment is not centered based on the calculated grid.	Can be caused by: <ul style="list-style-type: none"> <li>• Inconsistent print or marking speeds, vibration, or slippage interference</li> <li>• Odd shaped parts and incorrect print distance, angle, or speed.</li> <li>• Poorly managed artwork or pixel round off.</li> </ul>

### ISO/IEC 29158 2006 Grading Parameters

The ISO/IEC 29158 (AIM DPM) method of grading Data Matrix symbols modifies the process of ISO/IEC 15415 grading parameters, and is appropriate for direct part marking (DPM) applications.

The quality parameters and grading process for DPM codes are similar to ISO 15415, with a few key differences.

The first is the way the global threshold is determined. Global threshold is essentially the dividing line between light and dark cells. Global threshold defines whether a cell is closer to light or dark. To accommodate a variety of background surfaces, ISO/IEC 29158 calculates global threshold using a more sophisticated algorithm than ISO/IEC 15415 which results in an improved modulation.

ISO/IEC 29158 also allows the use of 30°, 90°, and dome lighting in addition to 45°. This makes verification on parts that are curved, reflective, or marked using dot peen possible.

ISO/IEC 29158 Parameter Name	Description	Possible solutions
Cell Contrast(CC)	Essentially the same as Symbol Contrast but made relative to light background.	<ul style="list-style-type: none"> <li>• Modify the substrate to incorporate more contrast between the light and dark modules</li> <li>• Add a light-colored background behind the code</li> <li>• Change the lighting angle</li> </ul>
Cell Modulation (CM)	A measure of the consistency of brightness, with the grading scale range from Global Threshold to Mean of distributions, rather than maximum and minimum reflectance. The DPM version of modulation.	<ul style="list-style-type: none"> <li>• Reduce BWG by adjusting the amount of ink used</li> <li>• Change the speed or temperature of the marking process Change pin size or replace with new pin</li> </ul>

ISO/IEC 29158 Parameter Name	Description	Possible solutions
Distributed Damage (DD)	<p>Similar to AG in ISO 15415, this parameter takes into account the effect of multiple segments of the fixed pattern having imperfections. Where multiple segments have a low grade, the effect of this “distributed damage” is reflected in a lower grade for DDG than the lowest of the individual segments.</p> <p>All the Fixed Pattern Damage grading are not renamed but are functionally different since the global threshold and modulation grading scale are different.</p>	<ul style="list-style-type: none"> <li>• In general, symbols will obtain a significantly higher grade according to AIM DPM than ISO 15415. Therefore, grading according to AIM DPM is appropriate only when called for in an application specification.</li> <li>• Modulation overlay uses only A, B, and F levels instead of A, B, C, D, and F.</li> </ul>
Minimum Reflectance (MR)	<p>Checks that the brightness of the light elements is sufficient so that the exposure adjustment is not too extreme. Strictly speaking, the mean of the light elements must be at least 5% on an absolute calibrated scale of diffuse reflection. If this requirement is met, the grade will be A, otherwise it will be F.</p>	<ul style="list-style-type: none"> <li>• If the symbol has less than 5% contrast before the auto adjustment to the image ISO/IEC TR 29158 makes, it will fail.</li> <li>• Increasing brightness of the light elements could be done by pre-conditioning the substrate.</li> <li>• Try different lighting options.</li> <li>• MR is not graded, and given a pass automatically, when using 90 light.</li> </ul>

### Differences between ISO/IEC 15415 and ISO/IEC 29158 grading standards

There are two verification standards from the International Organization for Standardization (ISO) that govern two-dimensional (2D) and direct part mark (DPM) codes.

- 2D codes printed on a label use ISO/IEC 15415.
- 2D DPM codes use ISO/IEC TR 29158, also known as AIM DPM.

ISO/IEC 29158, the standard for DPM codes, is a modification to the ISO/IEC 15415 standard to accommodate the variety of substrates and marking types for DPM codes.

The differences between ISO/IEC 15415 and ISO/IEC 29158 are the following:

#### Aperture

Aperture refers to the circular sample that is captured at grid intersections. Each of those sample circles are what the software will use to determine whether a cell is dark or light. Too big or too little aperture will cause your grade to be less accurate.

- **In ISO/IEC 15415:** you can select your own aperture size. It is typically recommended that the aperture size is 80% of the module size.
- **In ISO/IEC TR 29158 (AIM DPM):** the software varies the size of the aperture until the symbol is decoded, and then repeats the grading with two different aperture sizes (50% and 80%). The better of the two grades is reported as the final grade.

When the reference decode algorithm fails to decode a symbol with both 50% and 80% aperture, the DECODE grade will be “F” and a note will be printed on the grade section of the report, even if the symbol is recognized and decoded with a different aperture size in an earlier phase of the grading procedure.

## Global Threshold

The global threshold is essentially the point on a scale from dark to light that determines if a cell is closer to light or closer to dark.

- **In ISO/IEC 15415:** the global threshold is a simple calculation of the median between the highest and lowest reflectivity values. The highest brightness ( $R_{\max}$  or RL) and the lowest brightness ( $R_{\min}$  or RD) are identified and then the global threshold is just the midpoint between these two extreme values.
- **In ISO/IEC TR 29158 (AIM DPM):** there are often some spots of glare which causes  $R_{\max}$  to be very different from most of the other spaces in the code. This is a problem because it makes the global threshold higher, and then some of the other spaces are close to that threshold which makes them get a low modulation value.

In the ISO/IEC 29158 standard for DPM codes, a more optimal threshold is calculated using an algorithm commonly known as "Otsu's Algorithm." At a high level, this algorithm computes the minimum of the variances between dark and light elements. This is a more ideal global threshold that will result in higher values of modulation. This is the most important reason why ISO /IEC TR 29158 gives higher grades than ISO 15415, especially on DPM codes.

## Lighting Options

- **In ISO/IEC 15415:** the default is four-sided 45° light.
- **In ISO/IEC TR 29158 (AIM DPM):** allows additional lighting angles to make illuminating challenging DPM codes possible: 30° lighting from four sides, 30° from two sides (which can be either north/south or east/west), and 90° diffuse on-axis lighting. The light source that is used is reported using a notation that includes the angle, and a letter (Q for 4, T for 2, and S for 1).

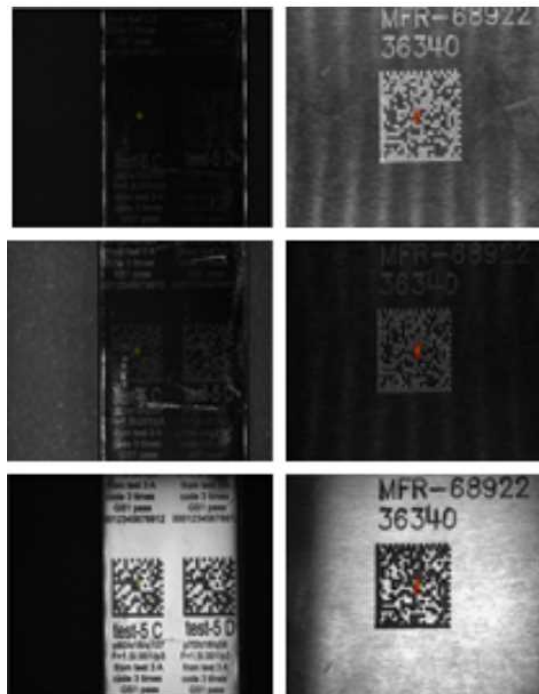

## Image Sensor

The image sensor works the same for ISO/IEC 15415 as with ISO/IEC TR 29158. However, in 29158, the exposure is adjusted automatically to brighten the image so that a darker code will look brighter and the full range of grayscale is used in the sensor. For both 15415 and 29158 the illumination intensity is very high so that ambient light has no practical contribution to the image. However, the exposure value is changed in 29158 compared to 15415.

## Calibration

Calibration is the process of mapping a camera's measurement to actual reflectance levels.

The process is done to find an exposure time that is needed to give a full brightness image on the calibration card. A calibration card has barcode symbols that are measured against a National Institute of Standards and Technology (NIST) traceable judge card to determine the exact Symbol Contrast  $R_{\min}/R_{\max}$  values. These values are entered into the verification software at the beginning of the process so that the software can adjust the camera accordingly.

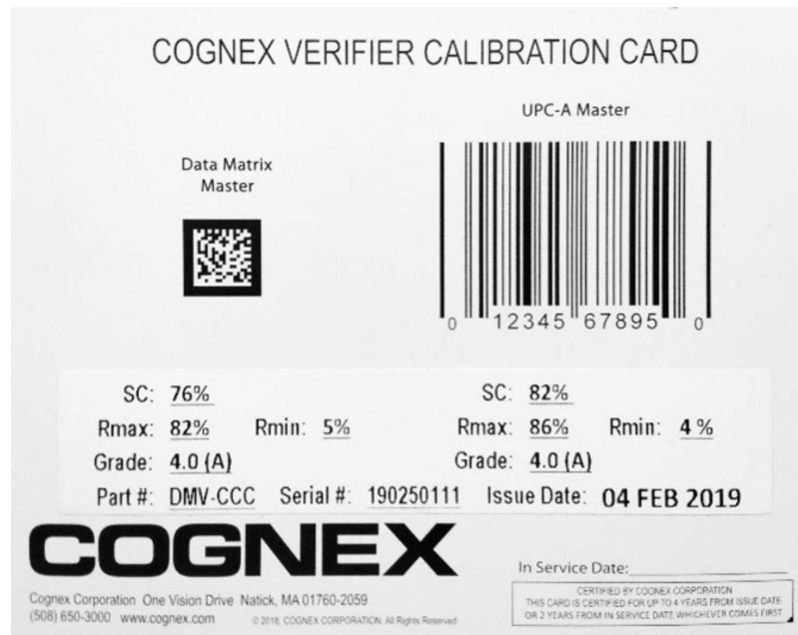

Currently, there are no DPM-specific calibration cards to challenge ISO/IEC 29158. A Data Matrix conformance test card can be used, but the contrast values will never perfectly match the value on the card because of the image adjustment used in 29158. Testing with the 29158 grading standard can be done to check for correct operation but will yield results that are different than those shown on the conformance card. It is recommended that the verifier also be tested using ISO/IEC 15415.

You can learn more about the differences of ISO/IEC 15415 and ISO/IEC 29158 grading standards [here](#).

## ISO/IEC 18004 QR Code Grading Parameters

- **ULP** (Upper Left Pattern), **URP** (Upper Right Pattern) and **LLP** (Lower Left Pattern): three identical components of the finder pattern found in the respective corners of the QR Code symbol. Each finder pattern is composed of 7x7 dark modules, 5x5 light modules, and 3x3 dark modules. MicroQR code contains one finder pattern in the upper left corner of the symbol.
- **HCT** (Horizontal Clock Track): The horizontal timing pattern consisting of a one module row of alternating dark and light modules.
- **VCT** (Vertical Clock Track): The vertical timing pattern, consisting of a one module row of alternating dark and light modules.
- **ALP** (Alignment Pattern): The alignment pattern consists of 5x5 dark modules, 3x3 light modules, and a single central dark module. The alignment pattern is only present in QR Codes version 2 or higher.
- **FIB** (Format Information Block): The format information block is the encoded pattern containing information on symbol characteristics such as the Error Correction Level and the data mask pattern.
- **VIB** (Version Information Block): The version information block is the encoded pattern containing information on the symbol version. The version information block is present on QR Codes version 7 or higher.

## Traditional (Non-Graded) Parameters

### PCS

A way of Quantifying Contrast is Print Contrast Signal (PCS), an older and rarely used measure of contrast. With Contrast you can quantify the difference between the bars and the spaces in reflectance. To calculate PCS mathematically:

$$PCS = (R_{max} - R_{min}) / R_{max}$$

PCS is equivalent to the percentage of the light background accounted for by the difference between the bars and spaces. PCS was defined as a measure of contrast the human eye perceives before and outside the context of measuring the barcode contrast. The measurement is made relative to the brightness of the background. The darker or the worse the background color is, the higher and supposedly the better the value of PCS. Scanners are sensitive to the absolute difference between the reflectance of bars and spaces. Readers are especially sensitive to variations in contrast within the same scan.

### MRD

Minimum Reflectance Difference (MRD) quantifies the minimum difference anywhere across the barcode. These worst-case bars and spaces are not necessary adjacent to one another.

### BWG

Bar width grow parameter indicates how much the amount a bar or element size deviates from the ideal size.

## Calibration Settings

The **Calibration Settings** menu allows you to enable a reminder for calibration as well as set the number of days that have elapsed since the previous calibration for the reminder. In addition, there is a button to **Discard Calibration** and return the verifier to an uncalibrated state.

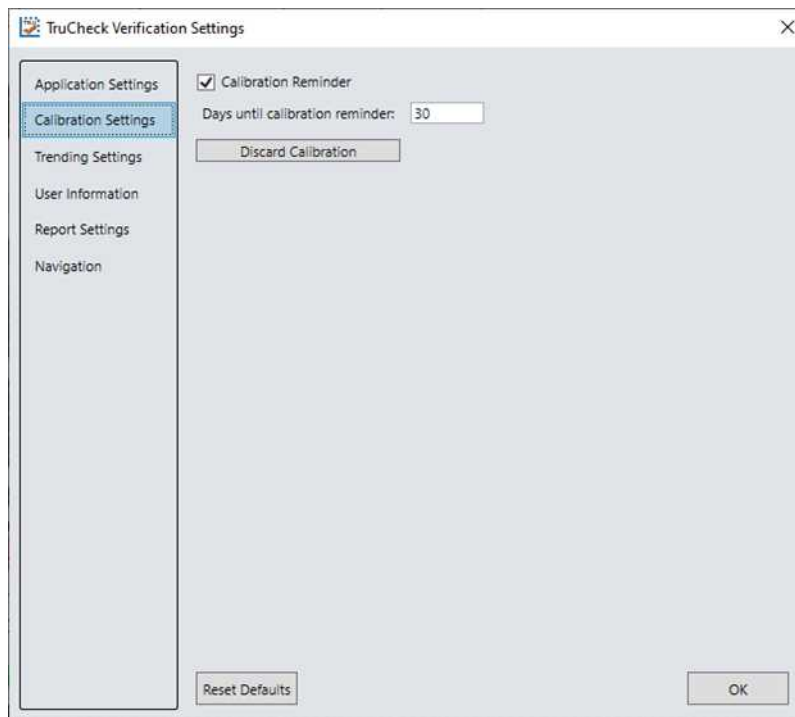

## Trending Settings

The **Trending Settings** menu allows users to set the threshold that determines if the trending is evaluated as Pass or Fail. With the option to set the values for x and y, you can establish an overall verification failure when X out of the last Y verifications fail the current application standard.

For example, if you set X to 3 and Y to 10, a message will show above the trending graph stating "Overall Verification Failure: 0 out of the last 0 verifications failed the current application standard. Threshold is 3/10" whenever 3 or more of the last 10 verifications resulted in a failing Overall Grade.

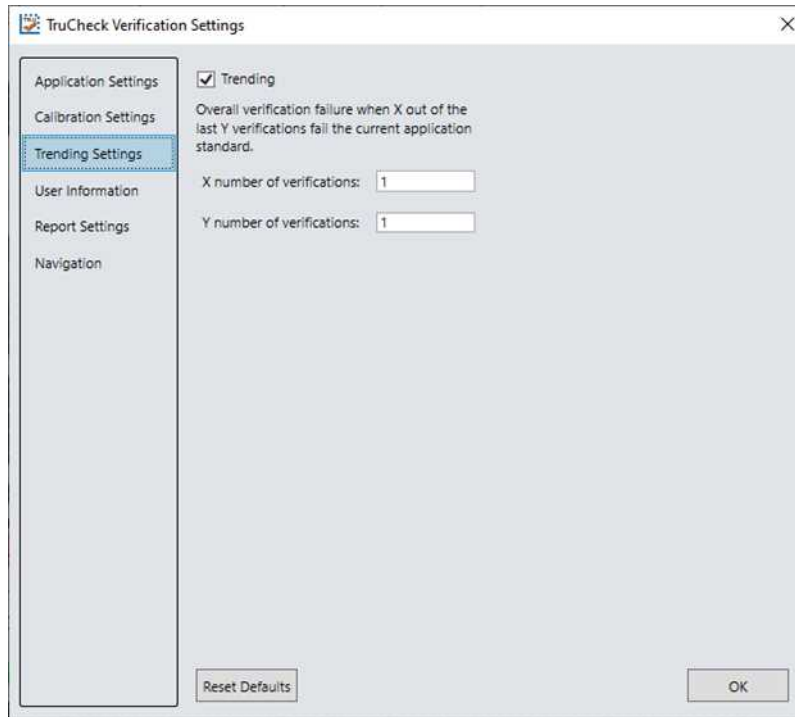

## User Information

The **User Information** menu provides fields for the user to include the Company Name, Operator Name, and Batch Number that are then added to the header of the report. Auto Batch check-box allows any batch number that is detected in the barcode to be added to the report. For example, if a GS1 DataMatrix symbol is verified that includes the Application Identifier for batch number, the batch number included is reported. Custom Note allows you to add a wide variety of information to the report.

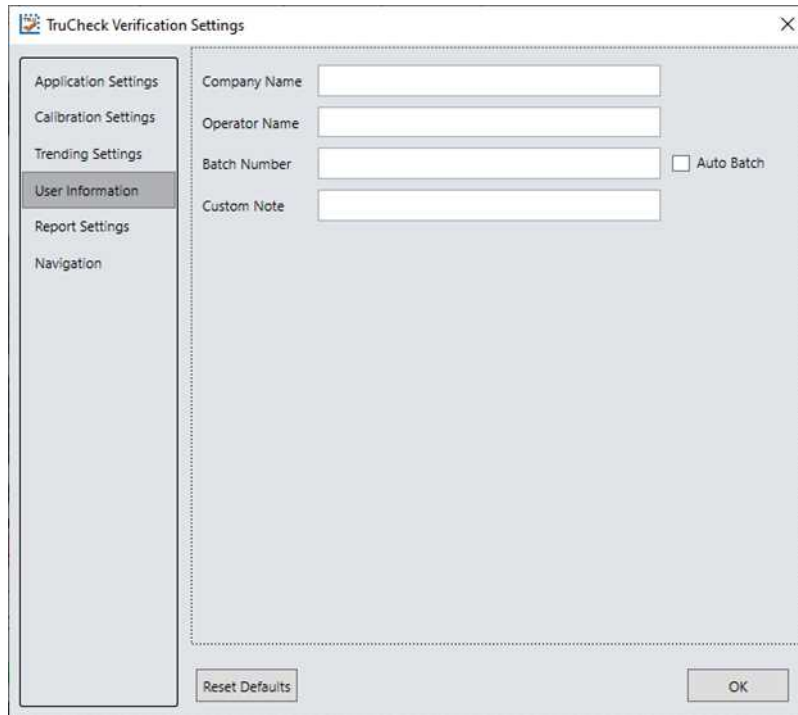

## Report Settings

The **Report Settings** menu allows you to select the unit of measurement for reporting values such as X-dimension.

The available options are: mils (thousandths of an inch), mm (millimeters), or um (micrometers).

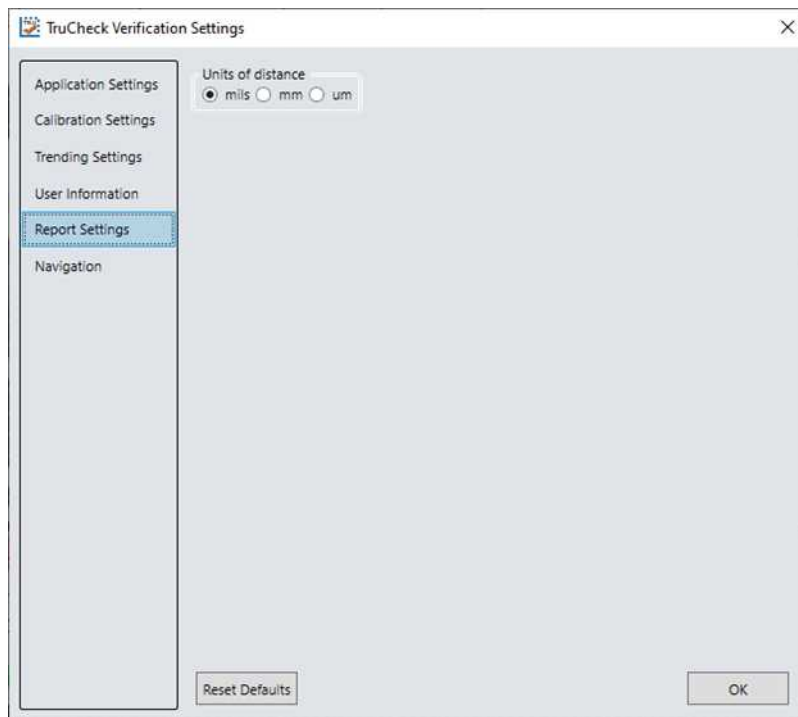

# Navigation

The **Navigation** menu allows you to access certain options in the Setup Tool window to configure exporting results either through Setup Tool or FTP. The Navigation menu also provides a shortcut to enable or disable symbologies and to set up the verifier to verify multiple symbols in one verification. Click the View button to re-direct to the settings of each reporting option in Setup Tool.

**Note:** Maximize Setup Tool for the shortcuts to work. For more information on Setup Tool Panes, see the **Setup Tool Reference Manual**.

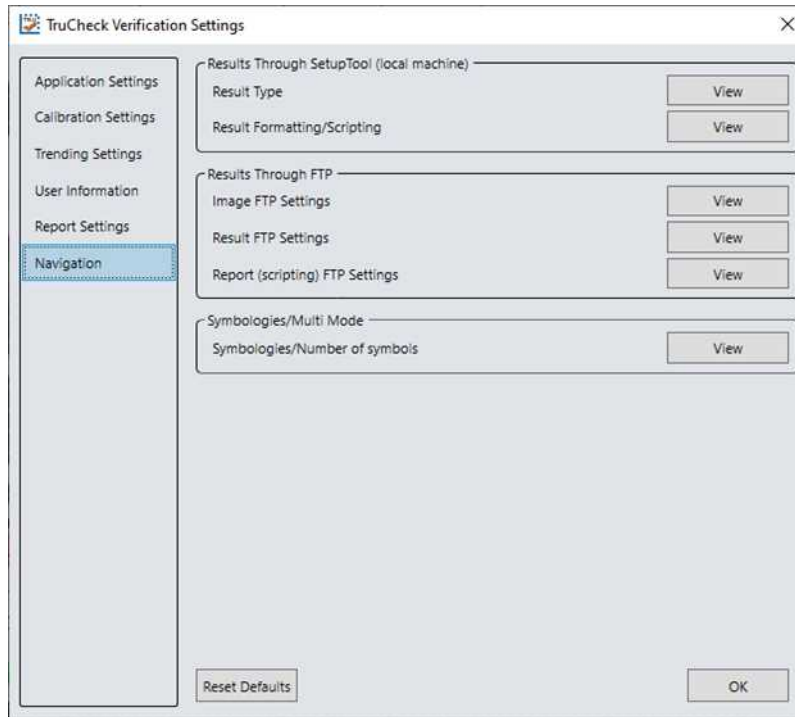

## Results through Setup Tool (local machine)

In the **Results through Setup Tool (local machine)** section, two options are available to navigate to the Setup Tool windows to set up a scripting menu for exporting verification results either as an HTML or CSV report:

- Result Type
- Result Formatting/Scripting

For more information on the scripting options available for verification, see [Scripting on page 64](#). For more information on broad scripting options available in Setup Tool, refer to the **Scripting** section of the **DataMan Communications & Programming Guide**.

### Result Type

Click **Result Type** to open the **Basic** tab in the **Format Data** application step in Setup Tool. Select **Script-Based Formatting** to enable scripting for export of verification data to CSV or to custom, script-defined format.

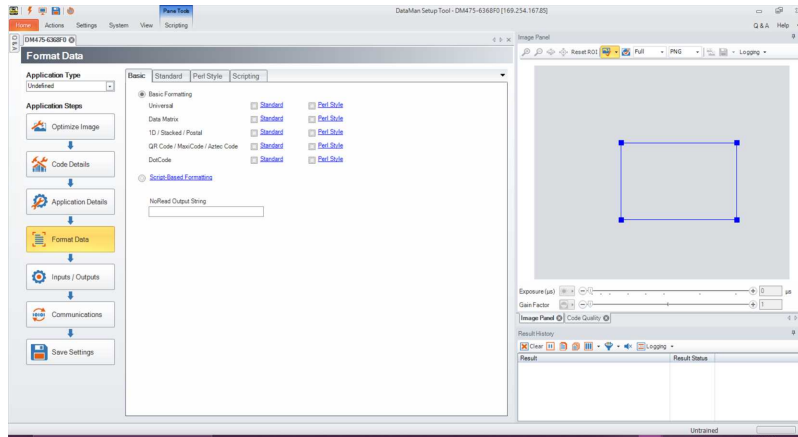

## Result Formatting/Scripting

Click **Result Formatting/Scripting** to open the **Scripting** tab in the **Format Data** application step in Setup Tool. Create a script for outputting results or load a pre-written snippet in this window.

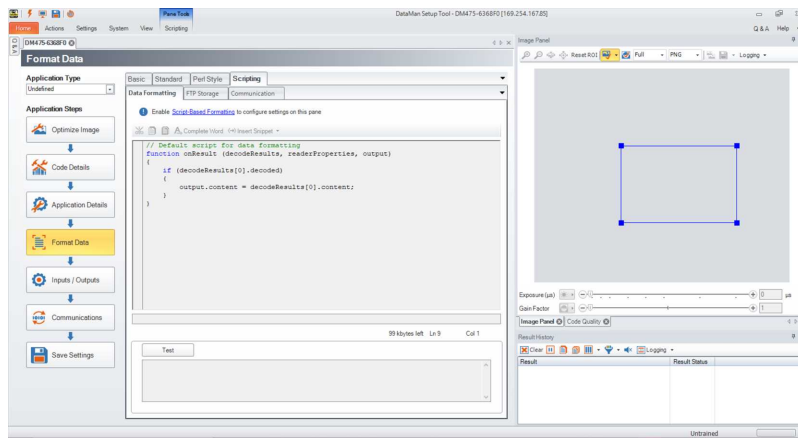

## Results through FTP

In the **Results through FTP** section, three options are available to navigate to windows in the Setup Tool that connect to an FTP server for exporting verification:

- Image FTP Settings
- Result FTP Settings
- Report (scripting) FTP Settings

For more information, see [Setting Up FTP Transfer on page 65](#).

## Image FTP Settings

Click **Image FTP Settings** to open the **Image Transfer** tab in the **Format Data** application step in Setup Tool. Enter information in this window to set up image export via FTP transfer.

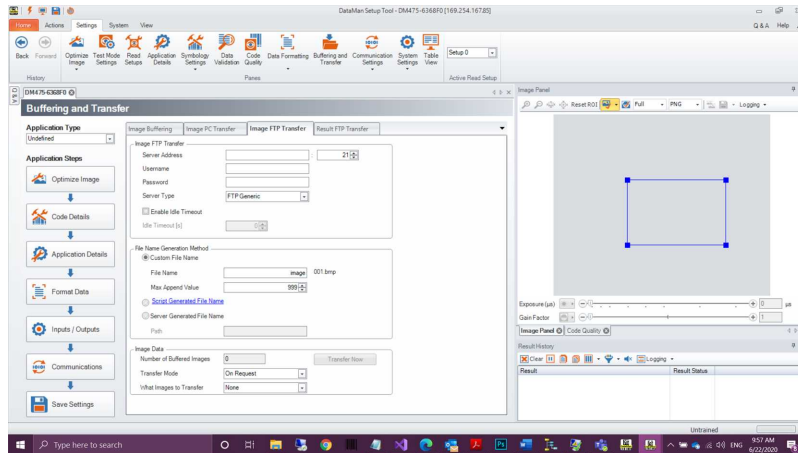

## Result FTP Settings

Click **Result FTP Settings** to open the **Result FTP Transfer** tab in the **Format Data** pane in Setup Tool. Enter information in this window to export verification results via FTP transfer.

**Note:** Minimize TruCheck window and click Setup Tool window on the taskbar.

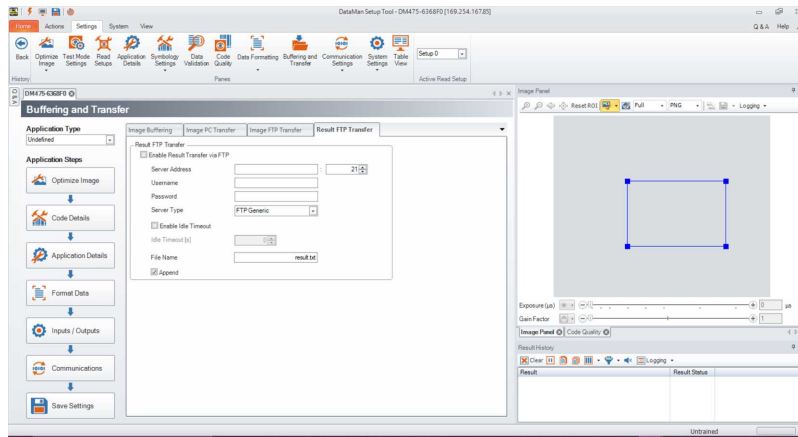

## Report (scripting) FTP Settings

Click **Report FTP Settings** to open the **Report FTP Transfer** tab in the **Code Quality** application step in Setup Tool. Enter information in this window to export verification results via FTP Transfer.

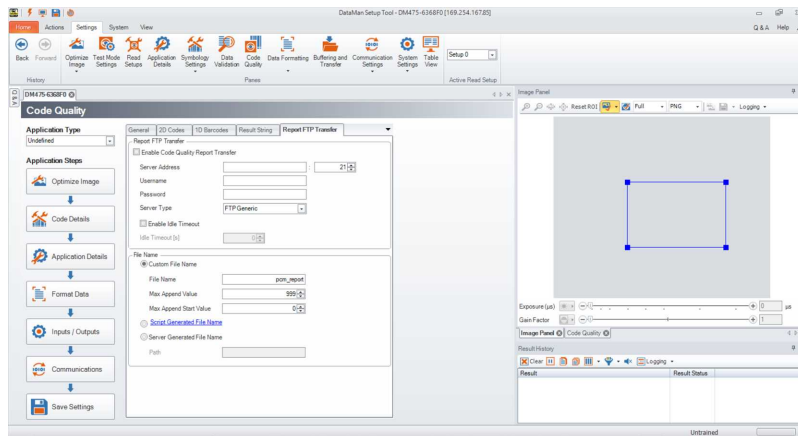



2. Select the **Scripting** tab on the ribbon menu.

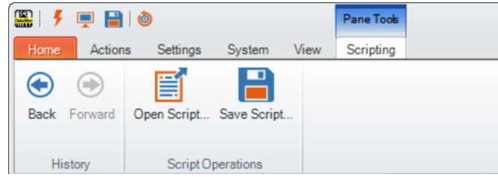

3. In the **Scripting** pane on the ribbon, click **Open Script**.
4. Navigate to the location of the Scripting templates: C:\Program Files (x86)\Cognex\DataMan\DataMan Software vx.x.x\Scripts. One scripting template generates results to a .CSV file and the other generates results to an .HTML file.
5. To save the output to a file, click the **Results History** window on the right.
6. In the **Logging** option, check the box to **Log all result codes to file system** and select the option for **Logging and reporting settings....**

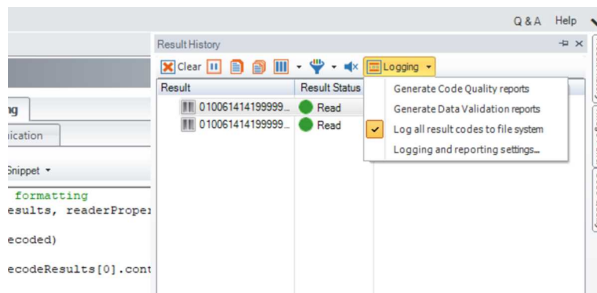

7. In the **Logging and reporting settings** menu, enter a file **Path** and **File Name** under the **Result Code** section. After providing a **File Name**, you must include either .CSV or .HTML depending on which template is selected.
8. Select **OK** to save and exit.

**Note:** If you do not include .CSV or .HTML after the file name, Setup Tool will not save the report correctly.

Result Code

Path

File Name

You can customize the scripts to show more or less detail. For the full list of scripting options, see the **DataMan Communications and Programming Guide**.

## Setting Up FTP Transfer

To configure the Dataman 475V to export verification results through FTP, change settings in Setup Tool to communicate with an external FTP server. Setup Tool can export information about:

- The image used for verification
- The result information provided from the **Result History** pane in Setup Tool
- The verification results provided in the **Code Quality** report.

To begin setting up an FTP server, configure an FTP server to communicate with Setup Tool. To set up the necessary information in the Setup Tool window, choose from three panes available for FTP transfer depending on what you would like to transfer:

- Image FTP Transfer
- Result FTP Transfer
- Report (scripting) FTP Transfer

The TruCheck window provides shortcuts to the three Setup Tool panes *Settings>Navigation>Results through FTP* menu. For more information, see [Results through FTP on page 62](#).

You can also click **Settings** in Setup Tool on the ribbon menu and open **Buffering and Transfer** to access the FTP settings.

## Image FTP Transfer

To set up image transfer via FTP, fill in the **Server Address**, the **Username**, and the **Password** (if applicable) fields depending on the setup of your FTP server settings.

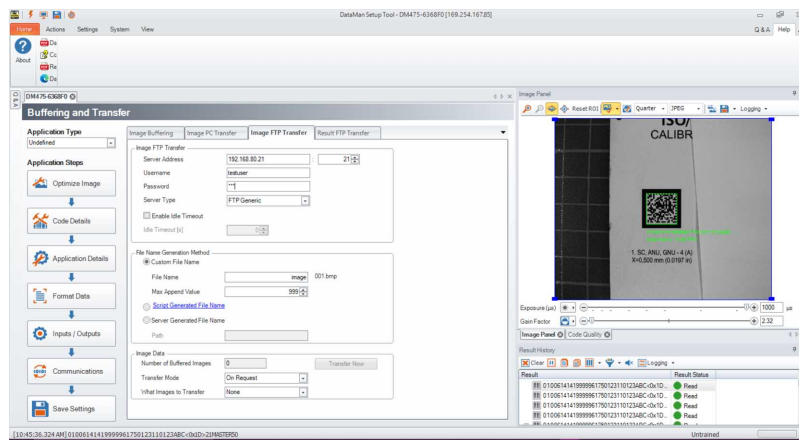

## Result FTP Transfer

To set up result transfer via FTP, fill in the **Server Address**, the **Username**, and, if the software prompts you, the **Password** fields, depending on the setup of your FTP server. Selecting this option exports the results available in the **Result History** pane of Setup Tool for exporting to the FTP server. After all required fields are filled in, select the box next to **Enable Result Transfer via FTP**. Use the FTP Transfer setting when exporting verification results using scripting. In case of using one of the included CSV script snippets, include the .csv file extension at the end of the **File Name** field, for example *VerificationResults.csv*.

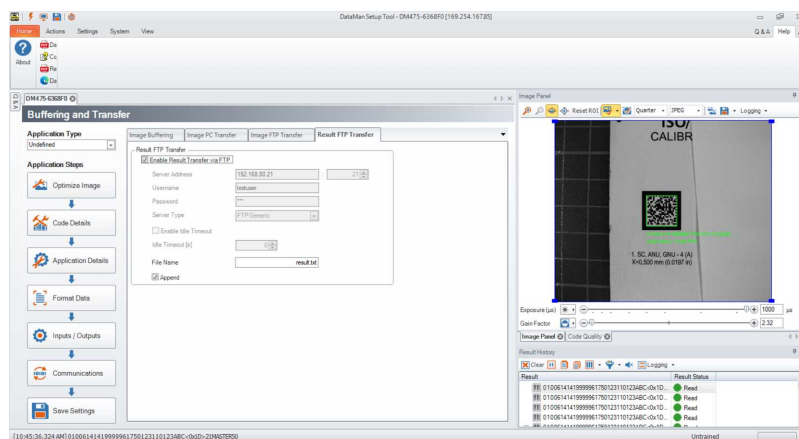

# Report FTP Transfer

To set up report transfer via FTP, fill in the **Server Address**, the **Username**, and the **Password** (if applicable) fields depending on the setup of your FTP server settings. Selecting this option exports the **Code Quality** report information to an FTP server. After all required fields are filled in, select the box next to **Enable Code Quality Report Transfer**.

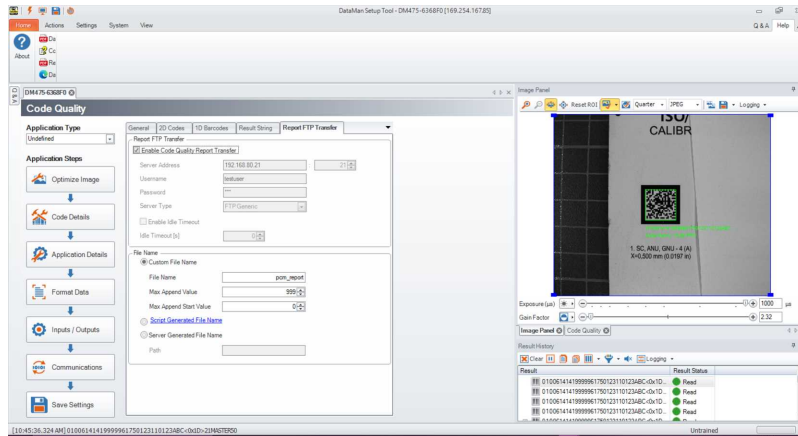

# Setting Up DataMan Setup Tool

This section provides information on the installation process of the DataMan Setup Tool and external triggers.

## Reading your first Code

Follow the steps below to install and connect your verifier to the DataMan Setup Tool:

1. Download the latest version of the DataMan Setup Tool from <http://www.cognex.com/support/dataman> and follow the on-screen steps.
2. Check the DataMan **Release Notes** for a full list of system requirements found at C:\Program Files (x86)\Cognex\DataMan\DataMan Software v6.1.9\Documentation\English.
3. Connect the DataMan 475 Verifier to your PC using the x-coded Ethernet cable and power the reader using the breakout cable.
4. Launch the DataMan Setup Tool and click **Refresh**.

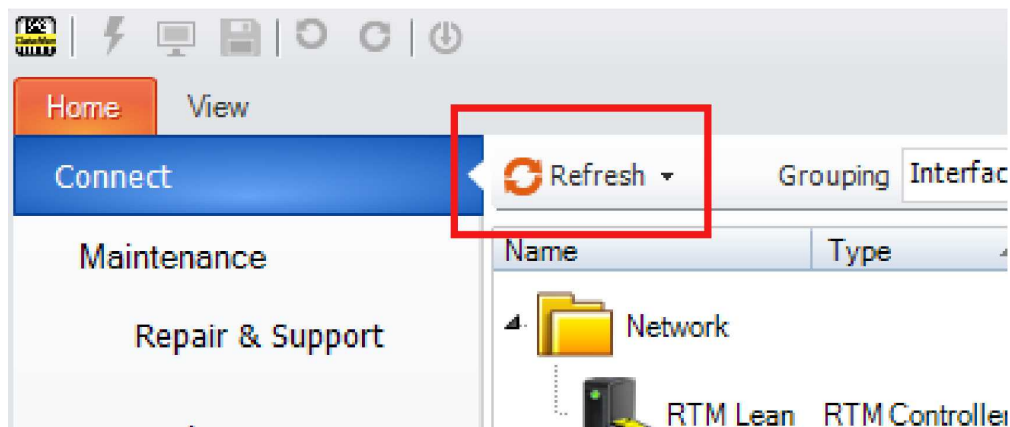

**Note:** Detected readers appear under **COM ports** or **Network devices**, or both.

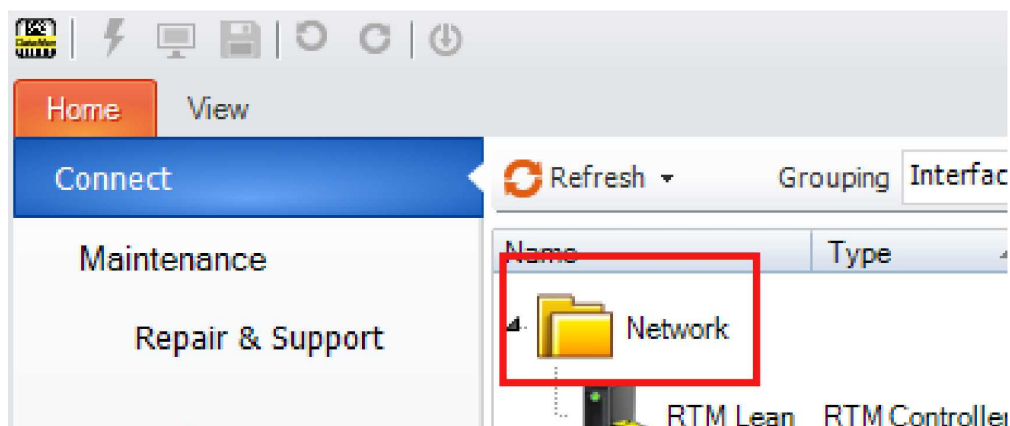

If the verifier does not appear in the list of devices, you can use either the **Add Device** or **Force Network Settings** options in the DataMan Setup Tool under **Repair & Support**. For more information, see the DataMan *Setup Tool Reference Manual*.

5. Select a verifier from the list and double click it or click **Connect**.

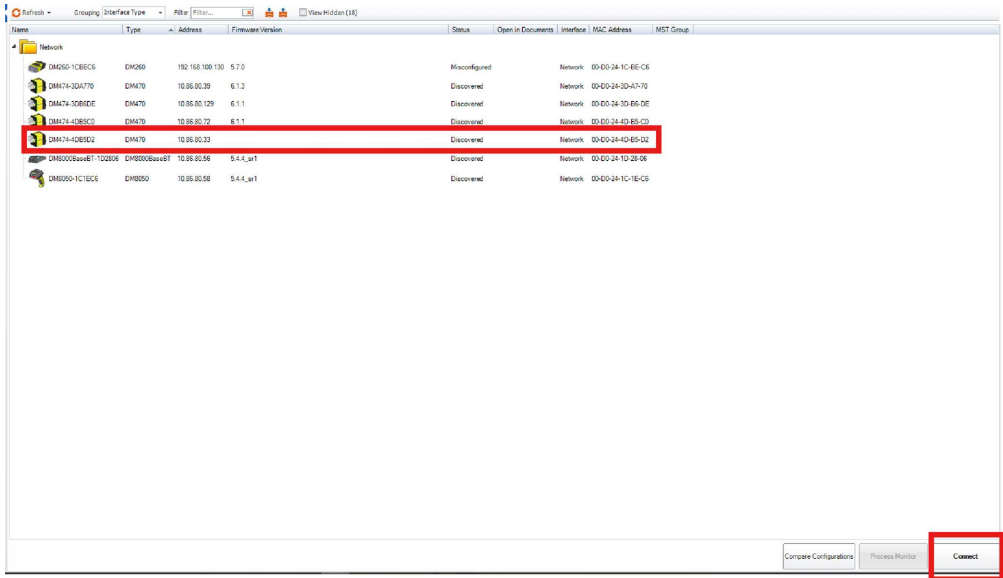

6. After connecting, the TruCheck window automatically opens.

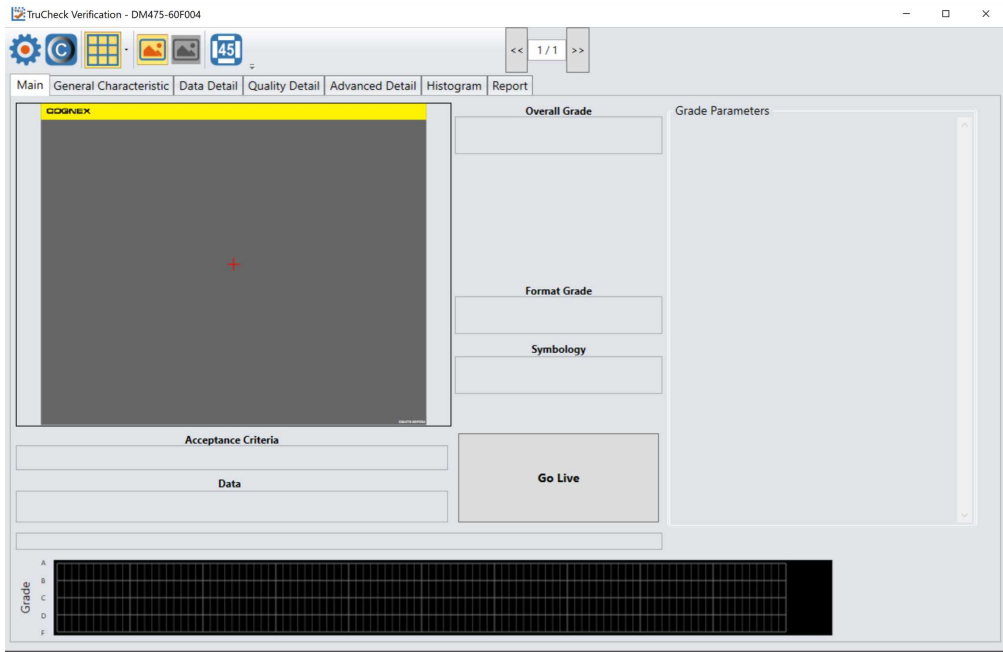

**Note:** If TruCheck window does not open or needs to be re-opened at any point during verification, select the TruCheck window icon under the **View menu on the ribbon bar** in Setup Tool.

**Note:** If you are running the DM475V at line speed, you may need to disconnect Setup Tool and obtain results through the device output interface.

**WARNING:** Do not stare into the beam when adding, removing, or changing cables. Cognex recommends to disconnect the reader from power whenever you make physical changes to it.

Follow the steps below to connect your reader to power and network:

**CAUTION:** Make sure that the verifier is not receiving power before you perform any I/O wiring or adjustments to I/O devices.

**CAUTION:** Make sure that the Ethernet cable is grounded at the far end. Whatever this cable is plugged into (usually a switch or router) should have a grounded Ethernet connector. Use a digital voltmeter to validate the grounding. If the far end device is not grounded, add a ground wire in compliance with local electrical codes.

1. Connect the I/O+RS232+24V cable to your reader.
2. Connect your reader through an Ethernet cable to your network for a network connection.
3. Connect the cable to a 24V power supply.

## External Triggers

If you are using external triggering, you can use any of the following methods to trigger your DataMan 475 Verifier :

- Press the trigger button on the reader.
- Send a pulse on the I/O cable:
  - Trigger + (orange or red)
  - Trigger - (black)
- Send a serial trigger command over the RS-232 connection connection.
- Press <CTRL-T> on the keyboard while the DataMan Setup Tool has the input focus.
- Click the **Trigger** button in the DataMan Setup Tool:

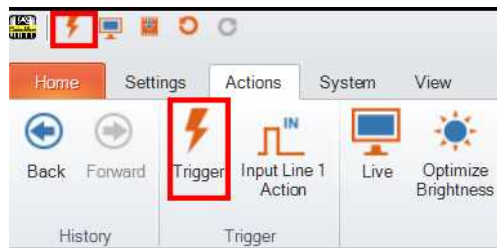

# Cleaning and Maintenance

## Cleaning the Verifier Housing

To clean the outside of the verifier housing, use a small amount of mild detergent cleaner or isopropyl alcohol on a cleaning cloth. Do not pour the cleaner directly onto the verifier housing.



**CAUTION:** Do not attempt to clean any DataMan product with harsh or corrosive solvents, including lye, methyl ethyl ketone (MEK) or gasoline.

---

## Cleaning the Verifier Lens Cover

To remove dust from the lens cover, use a pressurized air duster. The air must be free of oil, moisture or other contaminants that could remain on the lens cover. To clean the plastic window of the lens cover, use a small amount of isopropyl alcohol on a cleaning cloth. Do not scratch the plastic window. Do not pour the alcohol directly on the plastic window.

# Compliance Information, Warnings and Notices

## Precautions

To reduce the risk of injury or equipment damage, observe the following precautions when you install the Cognex product:

- The verifier is intended to be supplied by a UL or NRTL listed power supply with a 24VDC output rated for at least 2A continuous and a maximum short circuit current rating of less than 8A and a maximum power rating of less than 100VA and marked Class 2 or Limited Power Source (LPS). Any other voltage creates a risk of fire or shock and can damage the components. Applicable national and local wiring standards and rules must be followed.
- Route cables and wires away from high-current wiring or high-voltage power sources to reduce the risk of damage or malfunction from the following causes: over-voltage, line noise, electrostatic discharge (ESD), power surges, or other irregularities in the power supply.
- Do not install Cognex products where they are exposed to environmental hazards such as excessive heat, dust, moisture, humidity, impact, vibration, corrosive substances, flammable substances, or static electricity.
- Do not expose the image sensor to laser light. Image sensors can be damaged by direct, or reflected, laser light. If your application requires laser light that might strike the image sensor, use a lens filter at the corresponding laser wavelength. For suggestions, contact your local integrator or application engineer.
- Changes or modifications not expressly approved by the party responsible for regulatory compliance could void the user's authority to operate the equipment.
- Include service loops with cable connections.
- Ensure that the cable bend radius begins at least six inches from the connector. Cable shielding can be degraded or cables can be damaged or wear out faster if a service loop or bend radius is tighter than 10X the cable diameter.
- This device should be used in accordance with the instructions in this manual.
- All specifications are for reference purposes only and can change without notice.

## Regulations/Conformity

**Note:** For the most current CE declaration and regulatory conformity information, see the Cognex support site: [cognex.com/support](http://cognex.com/support).

DataMan 475 Verifier has Regulatory Model R00062, Label Light (DMV-475V-LBL-0200) has Accessory Model 50162, and meet or exceed the requirements of all applicable standards organizations for safe operation. However, as with any electrical equipment, the best way to ensure safe operation is to operate them according to the agency guidelines that follow. Please read these guidelines carefully before using your device.

Safety and Regulatory	
Manufacturer	Cognex Corporation One Vision Drive Natick, MA 01760 USA
USA	TÜV SÜD SCC/NRTL OSHA Scheme for UL/CAN 61010-1. FCC Part 15, Class A This equipment has been tested and found to comply with the limits for a Class A digital device, pursuant to part 15 of the FCC Rules. These limits are designed to provide reasonable protection against harmful interference when the equipment is operated in a commercial environment. This equipment generates, uses, and can radiate radio frequency energy and, if not installed and used in accordance with the instruction manual, may cause harmful interference to radio communications. Operation of this equipment in a residential area is likely to cause harmful interference in which case the user will be required to correct the interference at his own expense.
Canada	TÜV SÜD SCC/NRTL OSHA Scheme for UL/CAN 61010-1. ICES-003, Class A This Class A digital apparatus complies with Canadian ICES-003. Cet appareil numérique de la classe A est conforme à la norme NMB-003 du Canada.
Europe	DM475 (Regulatory Model R00062) Label Light (DMV-475V-LBL-0200) (Accessory Model 50162) The CE mark on the product indicates that the system has been tested to and conforms to the provisions noted within the 2014/30/EU Electromagnetic Compatibility Directive and the 2011/65/EU RoHS Directive. For further information, please contact: Cognex Corporation, One Vision Drive, Natick, MA 01760, USA. Cognex Corporation shall not be liable for use of our product with equipment (i.e., power supplies, personal computers, etc.) that is not CE.
Korea	A급 기기(업무용 방송통신기자재): 이 기기는 업무용(A급) 전자파적합기기로서 판매자 또는 사용자는 이 점을 주의하시기 바라며, 가정외의 지역에서 사용하는 것을 목적으로 합니다. DM475 (Regulatory Model R00062) Label Light (DMV-475V-LBL-0200) (Accessory Model 50162)
International Product Safety	Conforms to IEC 61010-1, CAN/CSA-C22.2 No. 61010-1:2012 + UPD No. 1:2015-07, UL 61010-1:2012 + R:2015-07, UL 61010-1:2012 + R:2015-07, EN 61010-1:2010.
CB	TÜV SÜD, IEC/EN 61010-1. CB report available upon request.

### For European Community Users

Cognex complies with Directive 2012/19/EU OF THE EUROPEAN PARLIAMENT AND OF THE COUNCIL of 4 July 2012 on waste electrical and electronic equipment (WEEE).

This product has required the extraction and use of natural resources for its production. It may contain hazardous substances that could impact health and the environment, if not properly disposed.

In order to avoid the dissemination of those substances in our environment and to diminish the pressure on the natural resources, we encourage you to use the appropriate take-back systems for product disposal. Those systems will reuse or recycle most of the materials of the product you are disposing in a sound way.



The crossed out wheeled bin symbol informs you that the product should not be disposed of along with municipal waste and invites you to use the appropriate separate take-back systems for product disposal.

If you need more information on the collection, reuse, and recycling systems, please contact your local or regional waste administration.

You may also contact your supplier for more information on the environmental performance of this product.

