

PC Vision Wiring Guide

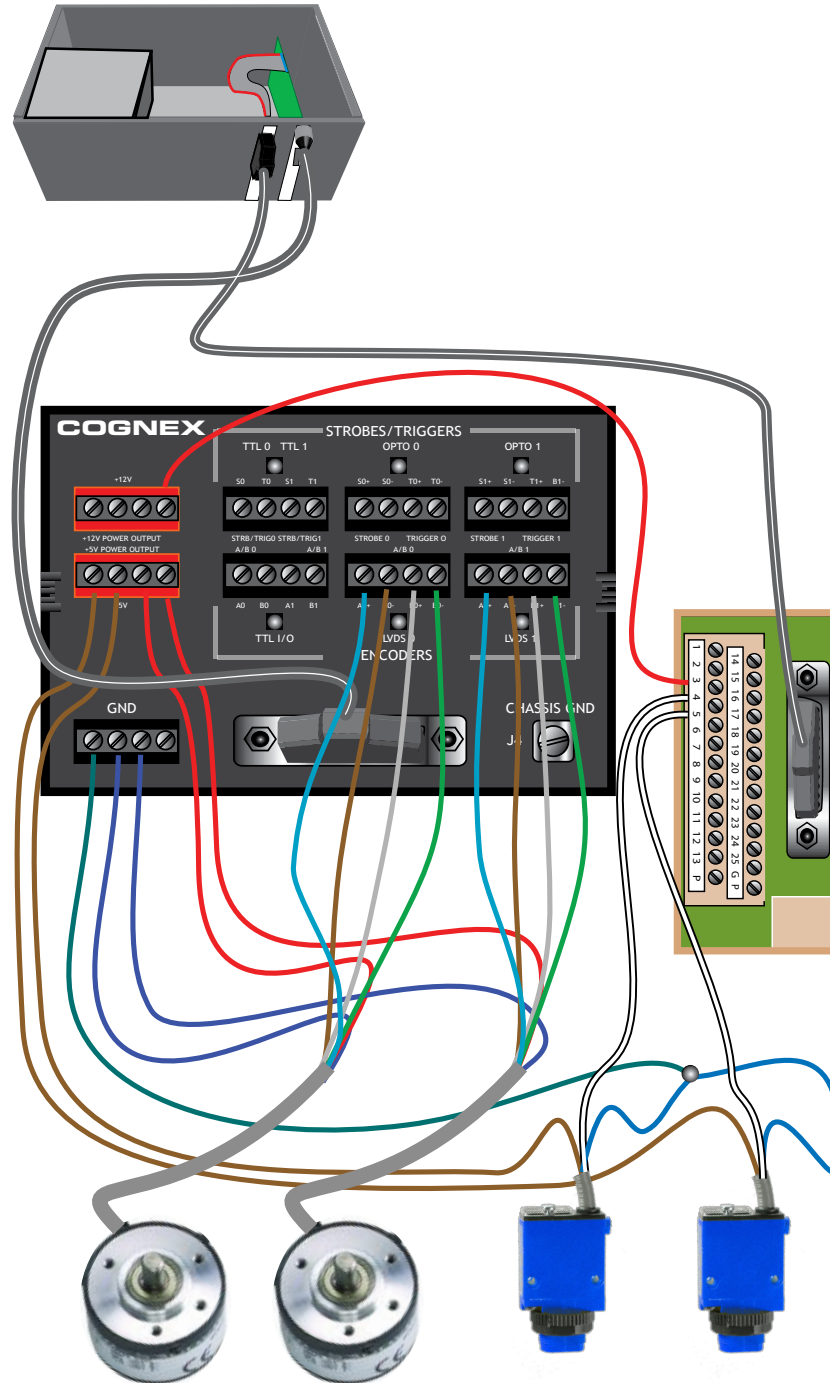

PC Vision Wiring Guide

About this Manual

The *PC Vision Wiring Guide* is a supplemental document that provides illustrated examples of how to solve common wiring problems when using Cognex PC Vision products.

Unless otherwise stated, all of the products and accessories described in this document are supported by both VisionPro and CVL.

For detailed information, including pin-out tables, electrical and mechanical characteristics, environmental requirements, certification information, and detailed circuit diagrams, refer to the hardware manuals for the products included on the product DVD and installed on your PC by default. You can also obtain this documentation from Cognex's support web site (<http://support.cognex.com>) and through the links in this document.

The wiring configurations shown in this document are *examples* of how you can connect Cognex equipment to common devices such as photoelectric sensors, PLC input and output modules, and stack lights. There are many additional methods that you can use to connect this equipment to these and other devices; consult the reference documentation for detailed information.









© Copyright 2015 Cognex Corporation All Rights Reserved

Table of Contents

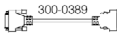

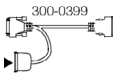









MVS-8500 and MVS-8600 I/O Products	4
Basler scout and pilot Trigger and Strobe	6
Basler ace Trigger and Strobe	8
CIC Series Trigger and Strobe	10
Basler runner Line Scan	12
General-Purpose I/O Modules	
General-Purpose Digital I/O (PCI Bus Adapter)	14
General-Purpose Digital I/O (USB Adapter)	16
Cognex Communication Card with Terminal Block	18
MVS-8500 I/O	
MVS-8500 Opto-Isolated Wiring	20
MVS-8500 TTL Wiring	22
MVS-8600 I/O	
MVS-8600 Opto-Isolated Trigger and Strobe (Area Scan)	24
MVS-8600 TTL Trigger and Strobe (Area Scan)	26
MVS-8600 Opto-Isolated General-Purpose I/O	28
MVS-8600 Single LVDS Encoder (Line Scan)	30
MVS-8600 Dual LVDS Encoder (Line Scan)	32
MVS-8600 Single/Dual TTL Encoder (Line Scan)	34
MVS-8700	
MVS-8704e 4-Port GigE Vision Frame Grabber	36

MVS-8500 and MVS-8600 I/O Products

MVS-8500 I/O Modules, Cables, and Accessories

I/O Kit/Cable	Product ID	Provides	Includes	Component Part Number
TTL I/O Kit	IO-TTL-8500	16 bidirectional TTL lines	Breakout box 	800-5818-1
			Cable 	300-0390-5R
Opto I/O Kit	IO-OPTO-8500	8 opto-isolated inputs 8 opto-isolated outputs	Breakout box 	800-5712-3R
			Cable 	300-0389-5R
TTL <i>plus</i> Opto I/O Kit	IO-OPTO-TTL-8500	8 bidirectional TTL lines 4 opto-isolated inputs 4 opto-isolated outputs	Breakout box 	800-5712-3R
			Y-cable 	300-0399-5R
4-camera breakout cable (15")	300-0232-015R	Connect four cameras to MVS-8500 series	Cable 	300-0232-015R
4-camera breakout cable with power	300-0230-015R	Connect four cameras to MVS-8500 series	Cable 	300-0230-015R
2-camera breakout cable	300-9116-015R	Connect two cameras to MVS-8500Le	Cable 	300-9116-015R

MVS-8600 I/O Modules, Cables, and Accessories

I/O Kit/Cable	Product ID	Provides	Includes	Component Part Number
TTL Option I/O Module	CIO-8600-TTL	2 TTL or opto-isolated trigger inputs 1 or 2 TTL encoder inputs	Breakout box 	800-5885-1R
			Cable 	300-0540-5R
LVDS Option I/O Module	CIO-8600-LVDS	2 TTL or opto-isolated trigger inputs 2 TTL or opto-isolated strobe outputs 1 LVDS encoder input	Breakout box 	800-5885-1R
			Cable 	300-0539-5R
Dual-LVDS Option I/O Module	CIO-8600-DLVDS	1 or 2 LVDS encoder inputs	Breakout box 	800-5885-1R
			Cable 	300-0538-5R
			1 Cable/faceplate 	300-0240-011R
Dual-LVDS Trigger Kit	CIO-8600-DLVDS-TRG	2 TTL triggers for use with Dual-LVDS encoder inputs (use with CIO-8600-DLVDS)	1 Wiring block 	195-0330
			1 Extension cable 	185-0334
General Purpose I/O	CIO-8600-GPIO	2 TTL trigger inputs 2 TTL strobe outputs 8 opto-isolated input lines 8 opto-isolated output lines	2 Wiring blocks 	195-0330
			2 Extension cables 	185-0334
			2 Cables/faceplates 	300-0240-011R
Camera Link Cables	CCB-8600-M2S-nn (nn = 15 or 30)	Non-PoCL high-flex mini-to-standard connectors (15' and 30')	Cable	CCB-8600-M2S-nn (nn = 15 or 30)
	185-0241 (15') 185-0242 (30')	Non-PoCL high-flex standard-to-standard connectors (15' and 30')	Cable	185-0241 (15') 185-0242 (30')
	CCL-POCL-M25-15	PoCL-compatible high-flex cable, mini-to-standard connectors (15')	Cable	CCL-POCL-M25-15

Basler scout and pilot Trigger and Strobe

The Basler scout and pilot GigE Vision cameras provide trigger and strobe support. The cameras provide 2 general-purpose I/O lines, but these are not available through Cognex I/O programming interface. Refer to the camera documentation for information on using these lines.

- ▶ **You must use the Cognex GigE Vision Configurator to configure these cameras before using them.**

General Wiring Notes

- ▶ **The standard I/O cable (CGE-IO-CBL-BAS-3M) is intended for use in low-voltage TTL (5V) and CMOS (3.3V) environments only. Use the 24V cable (CGE-IO-CBL-BAS-24V) with 24V equipment such as PLCs and relays.**

Camera power and ground are supplied through 4 pins on the 12-pin Hirose connector. If you provide power through the flying lead cable, make sure to use all four leads to avoid excessive voltage drop. If you are using the Basler power supply, which is equipped with a Hirose connector, you must use the Y-cable (CGE-IO-CBL-BAS-Y) in addition to the I/O cable (CGE-IO-CBL-BAS-3M or CGE-IO-CBL-BAS-24V) to connect trigger and strobe lines. Both types of wiring are shown on the next page. Refer to the camera documentation for specific power requirements.

To connect GigE Vision cameras to your PC you must use a dedicated network interface card (NIC) that is separate from the NIC your PC uses for network traffic. A Cognex-supplied NIC (CGE-NIC1-1, CGE-NIC2, or CGE-NIC-4) is recommended.

The wiring diagram on the right shows how to use a network switch (CGE-SWITCH5) to connect multiple cameras. You can use additional switches, bridges, and routers to connect more cameras. You can also use a multi-port NIC. This NIC must be separate from the NIC your PC uses for network traffic.

The trigger and strobe I/O Cable (CGE-IO-CBL-BAS-3M or CGE-IO-CBL-BAS-24V) provides access to trigger and strobe connections as well as power. All trigger and strobe lines are opto-isolated. Both cables have the same wire colors, as listed in the following table.

Pin	Wire Color	Signal
1	White	Camera Input Power Ground. Pins 1 and 2 are connected inside the camera.
2	Green	Camera Input Power Ground. Pins 1 and 2 are connected inside the camera.
3	Blue	Input 1 (+5 to +24 VDC) (Trigger)
4	Red	Input 2 (+5 to +24 VDC)
5	Grey	I/O Input Ground
6	Black	I/O Output 1 (Strobe)
7	Purple	I/O Output 2
8	Brown	Camera Input Power, +12 to +24 VDC. Pins 8 and 9 are connected inside the camera.
9	Yellow	Camera Input Power, +12 to +24 VDC. Pins 8 and 9 are connected inside the camera.
10	Pink	I/O Output Power (+5 to +24 VDC)
11	Grey/Pink	I/O Output 3
12	Red/Blue	I/O Output 4

For more information:

- See VisionPro or CVL documentation topics on GigE Vision acquisition.
- See the GigE Vision manual supplied with VisionPro.
- See the camera hardware manual:
<http://www.baslerweb.com/Downloads-13469.html?type=3&series=0&model=0>

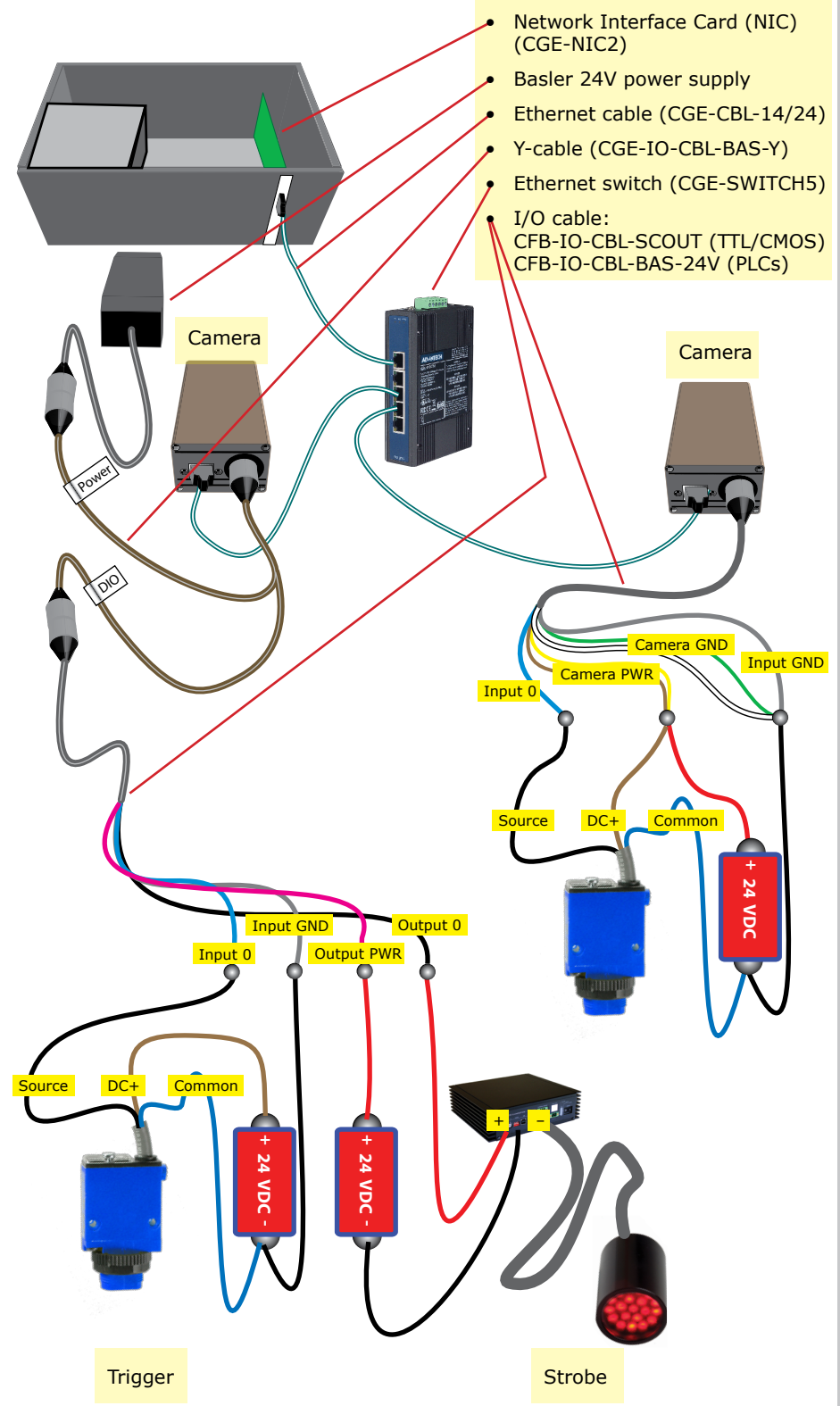

- Network Interface Card (NIC) (CGE-NIC2)
- Basler 24V power supply
- Ethernet cable (CGE-CBL-14/24)
- Y-cable (CGE-IO-CBL-BAS-Y)
- Ethernet switch (CGE-SWITCH5)
- I/O cable:
 CFB-IO-CBL-SCOUT (TTL/CMOS)
 CFB-IO-CBL-BAS-24V (PLCs)

CIC Series Trigger and Strobe

The following Cognex Industrial GigE Vision Cameras provide trigger and strobe support:

- CAM-CIC-300-120-G
- CAM-CIC-2000-20-G
- CAM-CIC-4000-25-G
- CAM-CIC-5000R-14-G

▶ **You must use the Cognex GigE Vision Configurator to configure these cameras before using them.**

General Wiring Notes

▶ **The standard I/O cable (COG-IO-CBL-6P-10M) is intended for use in low-voltage TTL (5V) and CMOS (3.3V) environments only. Use the 24V cable (COG-IO-CBL-6P-PLC) with 24V equipment such as PLCs and relays.**

Camera power and ground may be supplied in two ways: through the RJ-45 Ethernet connector using the Power over Ethernet (PoE) standard or through pins 1 and 6 on the 6-pin Hirose connector. If power is supplied through both sources, the camera will draw from the first connection that is detected.

If you use the power supply (CGE-PWR-ACE), you will not have access to the camera trigger and strobe lines.

To connect GigE Vision cameras to your PC, you must use a dedicated network interface card (NIC) that is separate from the NIC your PC uses for network traffic. A Cognex-supplied NIC (CGE-NIC1-1, CGE-NIC2, or CGE-NIC4) is recommended.

You can use a stand-alone PoE injector (CGE-POE-INJ-ACE) to provide power over the Ethernet connection, or you can use a PoE-enabled NIC (CGE-POE-NIC2) to provide power to the camera. Alternately, you can use an integrated PoE injector/switch (CGE-POE-SWITCH8) to power multiple cameras over Ethernet.

The wiring diagram on the right shows two externally powered cameras connected to a non-PoE network switch (CGE-SWITCH5) as well as a third camera powered over Ethernet using a PoE injector (CGE-POE-INJ-ACE).

Refer to the GigE Vision Cameras User's Guide for information on jumbo frame support if you are using the NETGEAR GS110TP Power over Ethernet switch.

The trigger and strobe I/O Cable (COG-IO-CBL-6P-10M or COG-IO-CBL-6P-PLC) provides access to trigger and strobe connections as well as power. All trigger and strobe lines are opto-isolated.

▶ **The lead colors for the I/O cables are different. The table below lists the lead colors for both cables.**

Pin	Wire Color		Signal
	COG-IO-CBL-6P-10M	COG-IO-CBL-6P-PLC	
1	Brown	Brown	Camera Input Power (+12 VDC)
2	Pink	Green	Input 0 (+5 to +24 VDC) (Trigger)
3	Green	Pink	not connected
4	Yellow	Yellow	Output 0
5	Grey	Grey	I/O Ground
6	White	White	Camera Input Power Ground

▶ **Refer to the CIC Getting Started Guide included with your camera for more installation and usage information.**

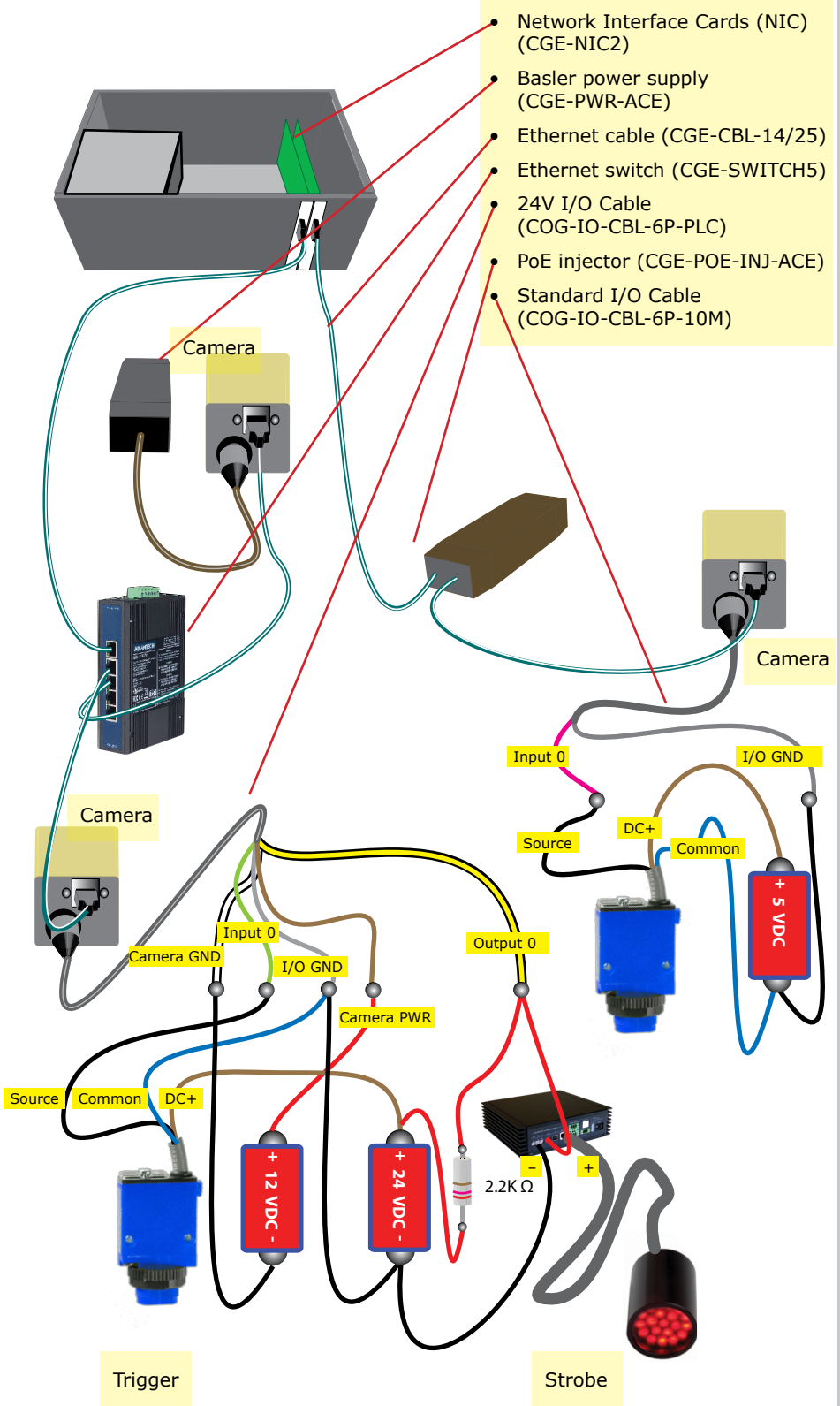

Basler runner Line Scan

To connect a Basler runner GigE Vision line scan camera to an encoder or a TTL or opto-isolated trigger, use the Basler I/O cable CGE-10-CBL-RNR-10M, with the following pin assignments:

Pin	Wire Color	Signal
1	White	I/O Input 1-
2	Brown	I/O Input 1+
3	Green	I/O Input 3-
4	Yellow	I/O Input 3+
8	Black	I/O Input 2-
9	Violet	I/O Input 2+

I/O line assignments are programmable. You can control which I/O pair receive encoder signals and frame triggers.

General Notes

- Cognex recommends the Basler I/O cable (CGE-IO-CBL-RNR-10M) for connecting the camera to the encoder and trigger.
- Reduce the output voltage from the trigger source from 24V to 5V to avoid damaging the GigE Vision camera.

You must configure the following parameters in order to use a Basler runner GigE Vision line scan camera:

- ROI parameters to define what will constitute a frame (4095 maximum height);
- Acquisition properties such as TriggerSelector, TriggerMode, and TriggerActivation;
- I/O properties such as line debounce and termination;

While it is possible to perform the camera configuration using CVL or VisionPro, Cognex recommends using the Basler pylon Viewer standalone application supplied with the camera.

For more information, see the Basler User's Manual for GigE Vision cameras at:

<http://www.baslerweb.com/Downloads-13469.html?type=3&series=7&model=0>

In addition, see the application note here:

<http://www.baslerweb.com/Downloads-13469.html?type=4&series=7&model=0>

To set the IP address of the GigE Vision network adapter and GigE Vision camera, use the GigE Vision Configuration Tool, installed with your CVL or VisionPro software.

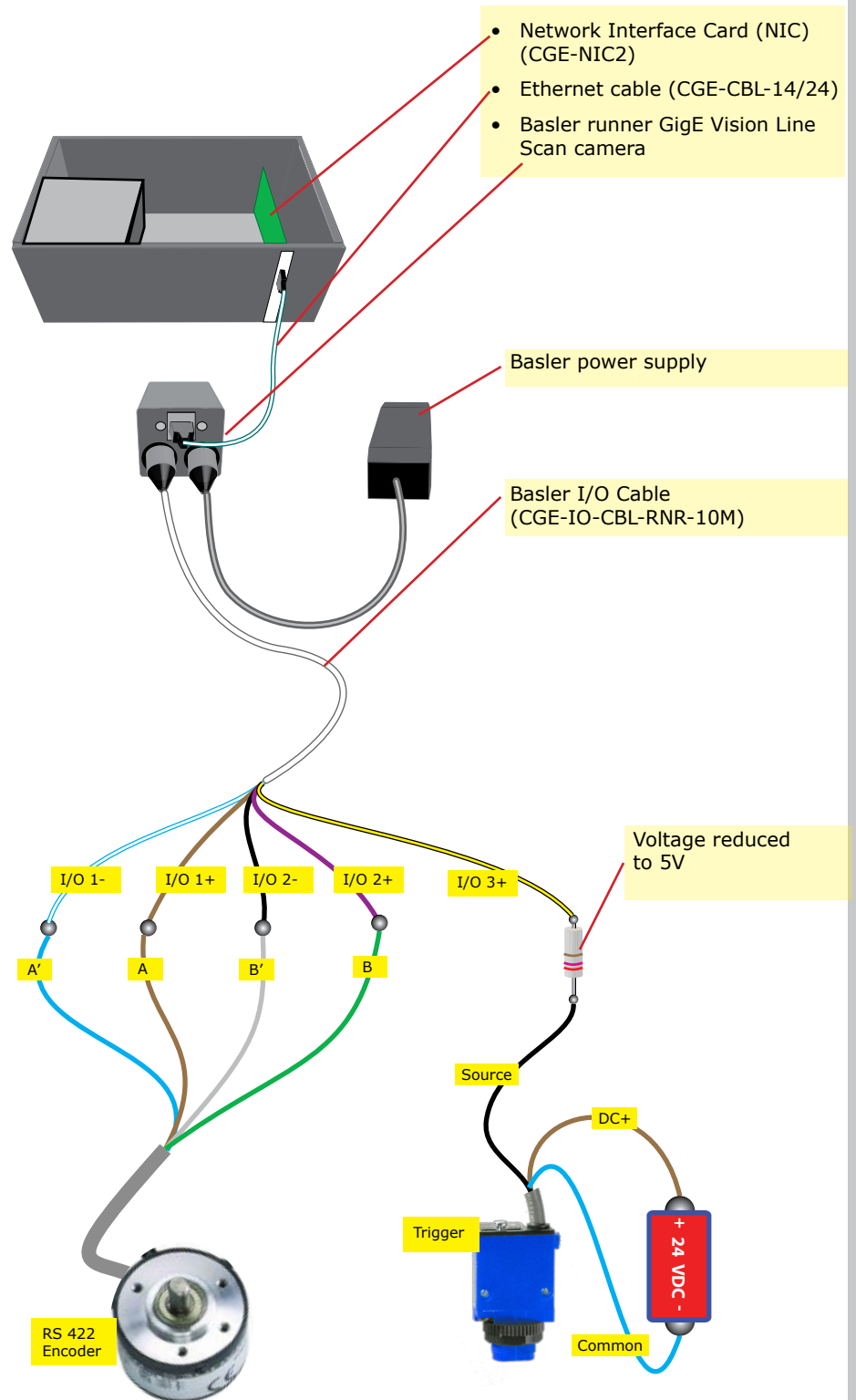

General-Purpose Digital I/O (PCI Bus Adapter)

► **Note: Only supported for VisionPro.**

General Wiring Notes

The CIO-PCI-P24S general-purpose digital I/O kit provides 24 bidirectional I/O lines, configurable using opto-isolated wiring. This kit can be used with any Cognex hardware, GigE Vision cameras, FireWire cameras, or third-party image acquisition devices.

The kit includes:

- A PCI bus adapter card for your PC
- A 3m cable
- An external circuit board providing wiring terminals and supporting standard solid-state relays (SSRs) for opto-isolation.
- The 8-line version of the I/O module, CIO-PCI-P8S, also includes a DIN rail mounting kit (173-0107).

The board's 24 lines are divided into four banks: lines 0-7, 8-15, 16-19, and 20-23. All lines within a bank must be configured as input or output lines.

The kit is not supplied with solid-state relays. They can be obtained from numerous vendors.

Signal Names

The lines are referred to in software as lines 0-23, corresponding to the line numbers on the module. In the Communications Explorer, the lines are shown as **Bidirectional 0-23**.

► **Note: If you are using the 8-line version of the I/O module, CIO-PCI-P8S, then the 8 lines on the I/O module correspond to lines 16-23 in the Communications Explorer.**

For more information:

- See topics on I/O line numbering and Communications Explorer in VisionPro online documentation.
- See the Measurement Computing Hardware Manuals:
 - <http://www.measurementcomputing.com/PDFManuals/PCI-DIO24-S.pdf>
 - <http://www.measurementcomputing.com/PDFManuals/SSR-RACK24.pdf>

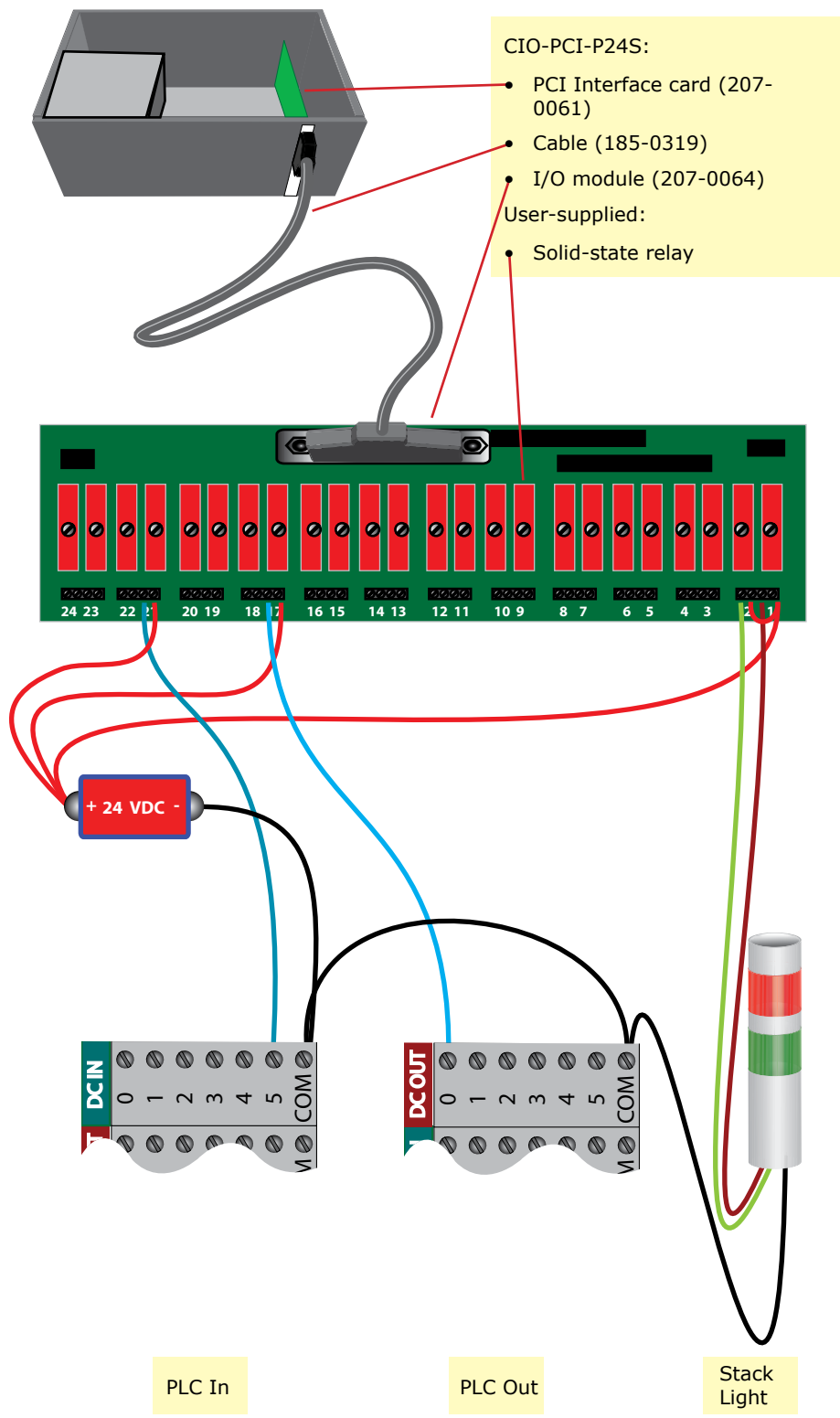

General-Purpose Digital I/O (USB Adapter)

► **Note: Only supported for VisionPro.**

General Wiring Notes

The CIO-USB-P24S Measurement Computing 1024LS/USB device provides 24 bidirectional TTL lines. The device provides 5V output and ground lines that you can use to perform contact-closure wiring. The device does not provide opto-isolation.

The 24 lines are divided into four banks: lines 0-7, 8-15, 16-19, and 20-23. All lines within a bank must be configured as input or output lines.

Signal Names

Pin assignments are listed below. **Pin** refers to the number printed on the device, **Signal** is the signal name used in the Measurement Computing documentation, and **Comm. Explorer Name** is the name to select in the VisionPro QuickBuild interface:

Pins 1-20			Pins 21-40		
Pin	Signal	Comm. Explorer Name	Pin	Signal	Comm. Explorer Name
1	C0	Bidirectional 16	21	A0	Bidirectional 0
2	C1	Bidirectional 17	22	A1	Bidirectional 1
3	C2	Bidirectional 18	23	A2	Bidirectional 2
4	C3	Bidirectional 19	24	A3	Bidirectional 3
5	C4	Bidirectional 20	25	A4	Bidirectional 4
6	C5	Bidirectional 21	26	A5	Bidirectional 5
7	C6	Bidirectional 22	27	A6	Bidirectional 6
8	C7	Bidirectional 23	28	A7	Bidirectional 7
9	GND		29	GND	
10	N/C		30	+5V	
11	N/C		31	GND	
12	GND		32	B0	Bidirectional 8
13	N/C		33	B1	Bidirectional 9
14	N/C		34	B2	Bidirectional 10
15	GND		35	B3	Bidirectional 11
16	N/C		36	B4	Bidirectional 12
17	GND		37	B5	Bidirectional 13
18	N/C		38	B6	Bidirectional 14
19	GND		39	B7	Bidirectional 15
20	CTR		40	GND	

For more information:

- See topics on I/O line numbering and Communications Explorer in VisionPro online documentation.
- See the Measurement Computing Hardware Manual: <http://www.measurementcomputing.com/PDFManuals/USB-1024LS.pdf>

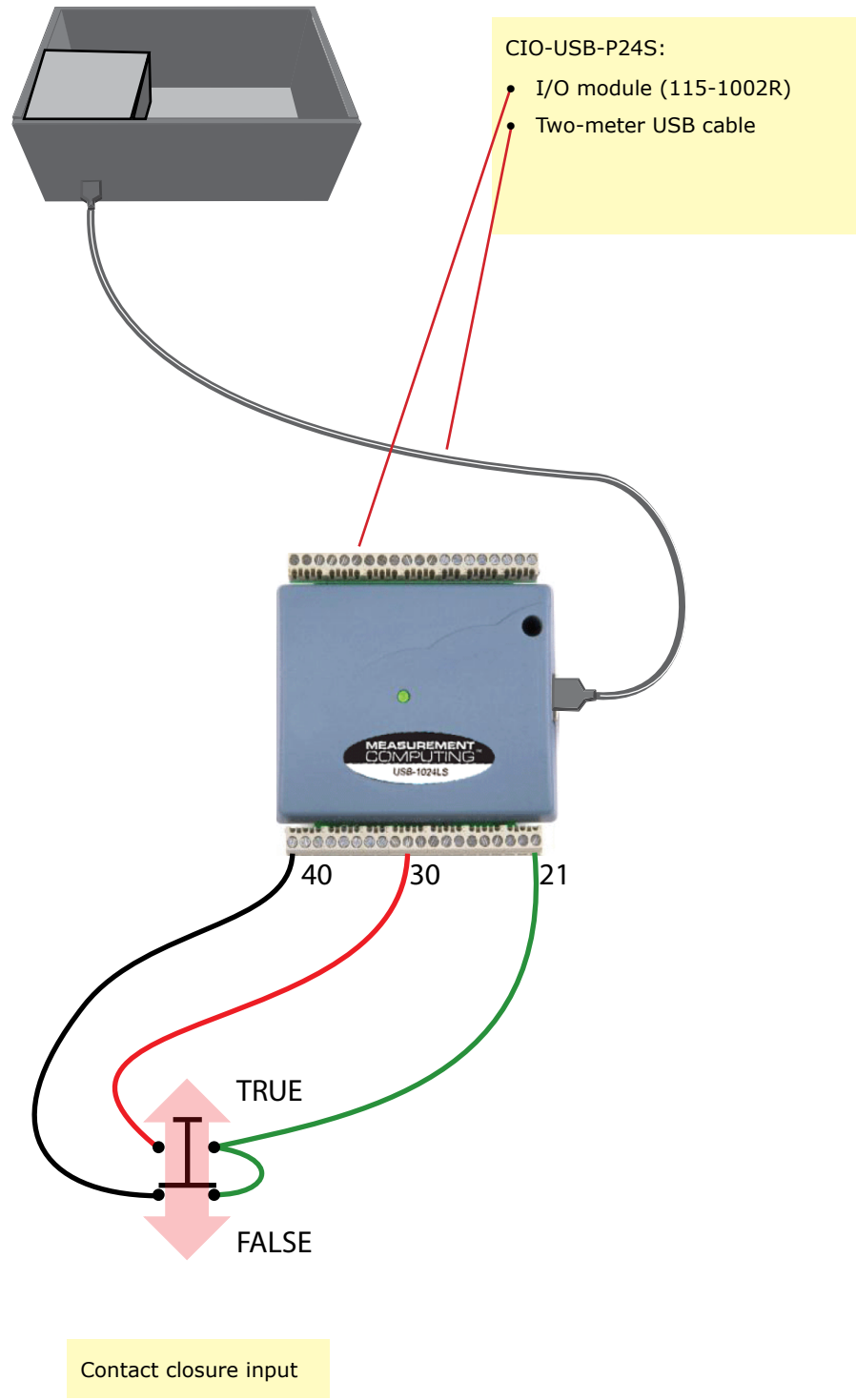

Cognex Communication Card with Terminal Block

The Communication card supports the connection of PLCs and photoelectric sensors, as well as general use I/O devices, such as relays, indicator lights and reject mechanisms. The Communication card also supports connection to either a single-ended or differential encoder.

► **Note: Only supported for VisionPro.**

General Wiring Notes

Recommended wiring is 12 - 24 AWG, solid or stranded wire. The maximum torque that can be applied to the I/O terminal connectors is 0.5 Nm to 0.6 Nm (4.4 in-lb to 5.3 in-lb). Applying torque above this limit can damage the connectors.

There are two sets of inputs: INPUTS 0 - 3 share the INPUT COMMON 1 connection and INPUTS 4 - 7 share the INPUT COMMON 2 connection. Therefore the input devices for each set of inputs must be the same; either current sinking or current sourcing.

There are four sets of outputs: OUTPUTS 0 - 3 share the OUTPUT COMMON 1 connection; OUTPUTS 4 - 7 share the OUTPUT COMMON 2 connection; OUTPUTS 8 - 11 share the OUTPUT COMMON 3 connection; and OUTPUTS 12 - 15 share the OUTPUT COMMON 4 connection. Therefore the output devices for each set of outputs must be the same; either current sinking or current sourcing.

OUTPUTS 0 - 7 provide up to 50mA current (maximum). OUTPUTS 8 - 15 provide up to 100mA of current (maximum).

Signal Names

Pin Label	Signal	Pin Label	Signal	Pin Label	Signal
I0	INPUT 0	O0	OUTPUT 0	O8	OUTPUT 8
I1	INPUT 1	O1	OUTPUT 1	O9	OUTPUT 9
I2	INPUT 2	O2	OUTPUT 2	O10	OUTPUT 10
I3	INPUT 3	O3	OUTPUT 3	O11	OUTPUT 11
I4	INPUT 4	O4	OUTPUT 4	O12	OUTPUT 12
I5	INPUT 5	O5	OUTPUT 5	O13	OUTPUT 13
I6	INPUT 6	O6	OUTPUT 6	O14	OUTPUT 14
I7	INPUT 7	O7	OUTPUT 7	O15	OUTPUT 15
IC1	INPUT COMMON 1	OC1	OUTPUT COMMON 1	OC3	OUTPUT COMMON 3
IC2	INPUT COMMON 2	OC2	OUTPUT COMMON 2	OC4	OUTPUT COMMON 4
B-	ENCODER B-	B+	ENCODER B+	N/A	UNUSED
A-	ENCODER A-	A+	ENCODER B-	N/A	UNUSED
GND	ENCODER GROUND	CG	CHASSIS GROUND	LG	LED GROUND

For more information and additional wiring examples:

- See the Cognex Communication Card Installation Manual.

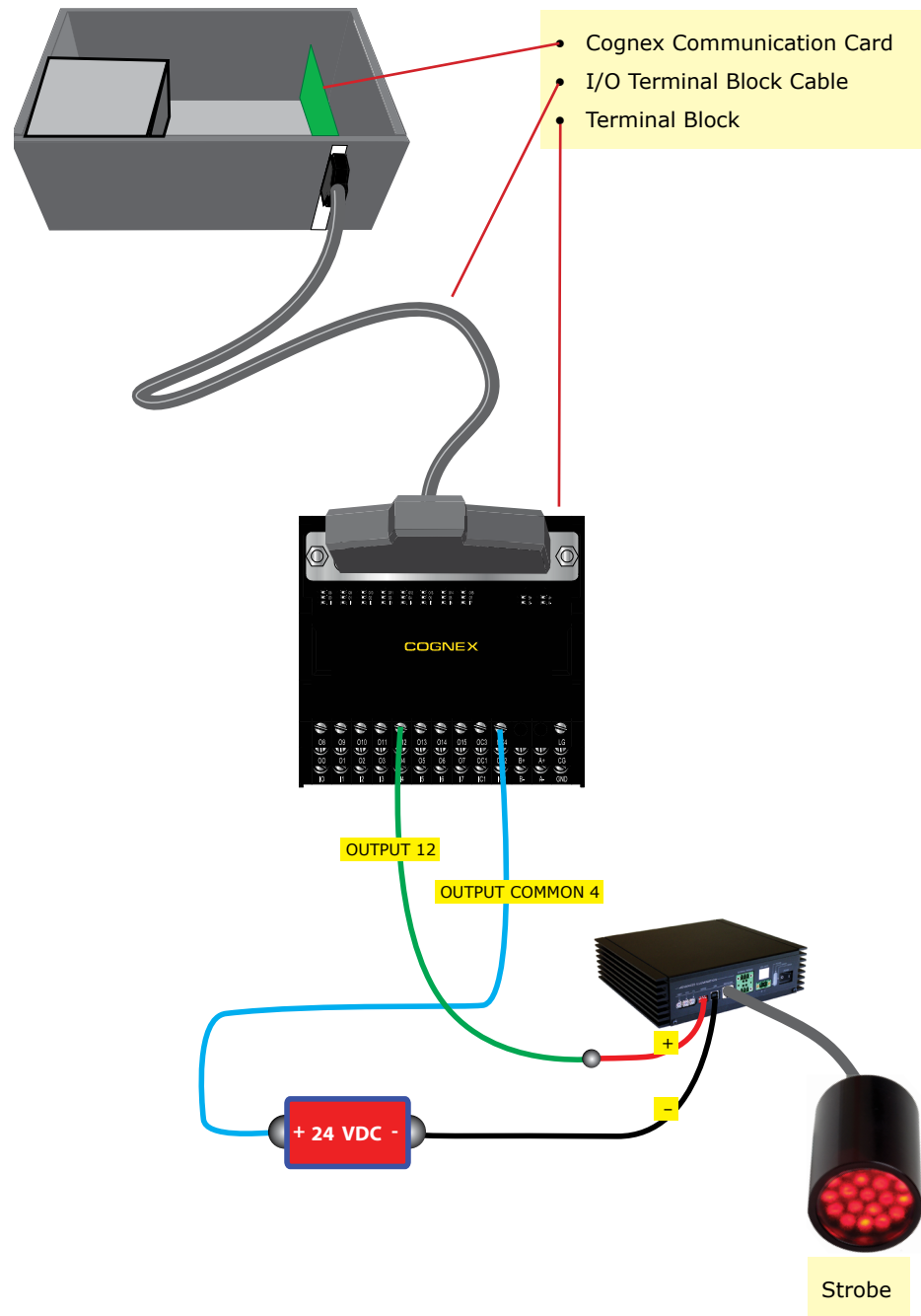

Strobe

MVS-8500 Opto-Isolated Wiring

The MVS-8500 provides opto-isolated connections for trigger inputs, strobe outputs, and general-purpose inputs and outputs using the IO-OPTO-8500 kit, which comprises an I/O module (800-5712-3R) and cable (300-0389-5R).

General Wiring Notes

Physical line state of Opto I/O module output lines is inverted from other modules. Logical true means no current flow; logical false means current flow.

Opto I/O module provides no power for input or output devices. All lines are polarity independent and can be connected to sinking or sourcing devices.

Keep in mind that you must specify, in software, which I/O configuration you are using.

Signal Names

The following table maps module lines to VisionPro software lines and Communications Explorer line names.

Inputs			Outputs		
Label	Software Line	Comm. Explorer Name	Label	Software Line	Comm. Explorer Name
IN0	0	Input 0	OUT0	4	Output 4
IN1	1	Input 1	OUT1	5	Output 5
IN2	2	Input 2	OUT2	6	Output 6
IN3	3	Input 3	OUT3	7	Output 7
IN4	8	T Input 8	OUT4	9	S Output 9
IN5	10	T Input 10	OUT5	11	S Output 11
IN6	12	T Input 12	OUT6	13	S Output 13
IN7	14	T Input 14	OUT7	15	S Output 15

Lines IN4-IN7 reserved as triggers for Camera 0-3; Lines OUT4-OUT7 reserved as strobes for cameras 0-3.

For more information:

- See MVS-8500 Hardware Manual.
- See topics on I/O line numbering and Communications Explorer in VisionPro online documentation.

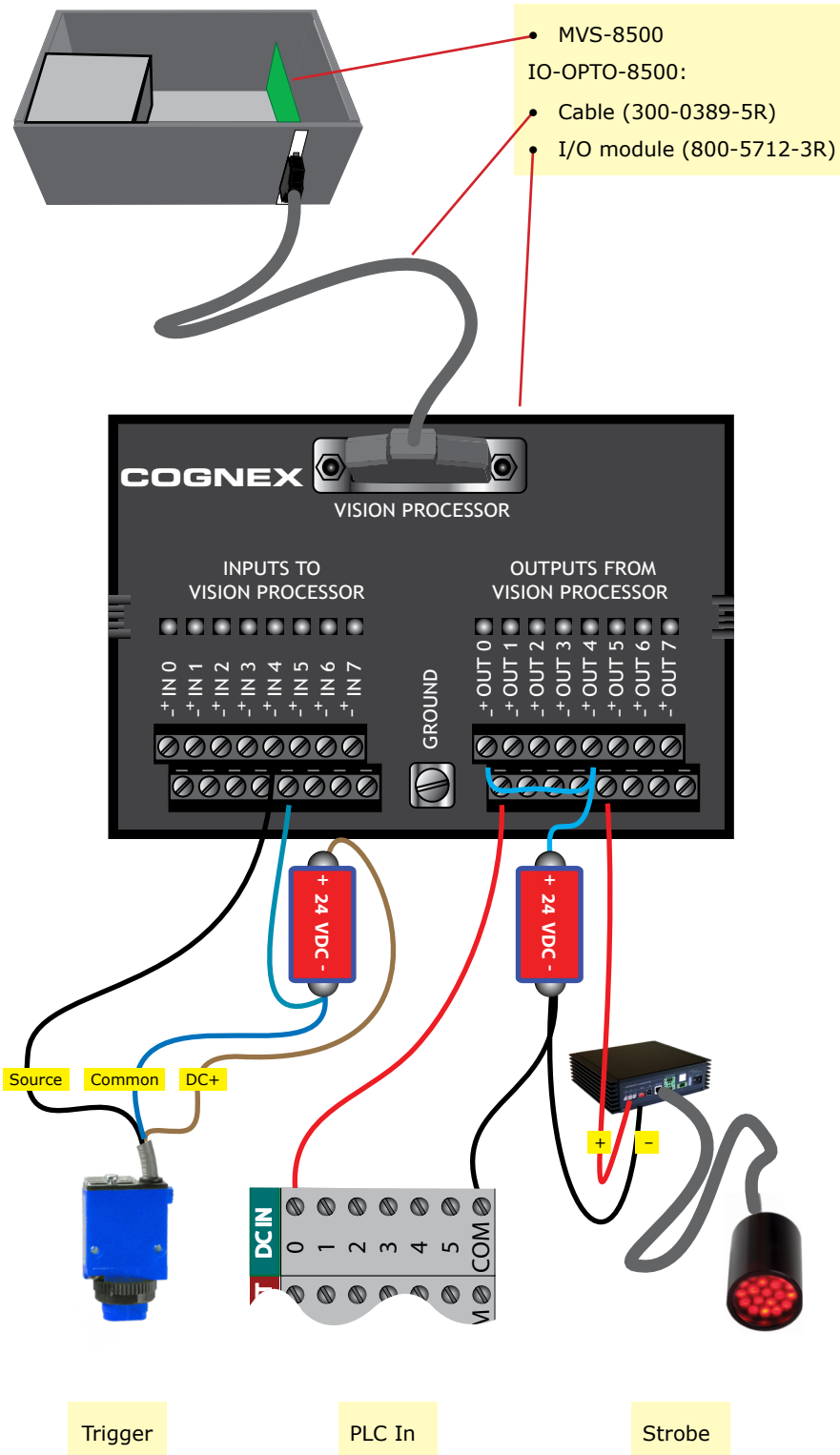

MVS-8500 TTL Wiring

The MVS-8500 provides TTL-level connections for triggers, strobes, and bidirectional I/O lines through the MDR-20 connector on the faceplate. Cognex recommends the use of the TTL I/O Kit (IO-TTL-8500), which provides an I/O module and extension cable.

General Wiring Notes

The lines designated as trigger and strobe lines can also be used for general-purpose I/O. To use them as triggers and strobes, they must be disabled as input or output lines.

Signal Names

The following table maps module lines to VisionPro software lines and Communications Explorer line names. The "Label" name refers to the printed label on the I/O module.

Label	Software Line	Comm. Explorer Name	Label	Software Line	Comm. Explorer Name
T1	8	TRIGGER1	B0	0	Bidirectional 0
S1	9	STROBE1	B1	1	Bidirectional 1
T2	10	TRIGGER2	B2	2	Bidirectional 2
S2	11	STROBE2	B3	3	Bidirectional 3
T3	12	TRIGGER3	B4	4	Bidirectional 4
S3	13	STROBE3	B5	5	Bidirectional 5
T4	14	TRIGGER4	B6	6	Bidirectional 6
S4	15	STROBE4	B7	7	Bidirectional 7

Pins labeled **G** are ground; pins labeled **NC** are not connected.

Combined (Split) TTL and Opto-Isolated Wiring

The IO-OPTO-TTL-8500 kit provides a combination of TTL and Opto-isolated wiring. This kit is described in detail in the MVS-8500 Hardware Manual.

For more information:

- TTL wiring and the TTL I/O module are described in detail in the MVS-8500 Hardware Manual.
- See topics on I/O line numbering and Communications Explorer in VisionPro online documentation.

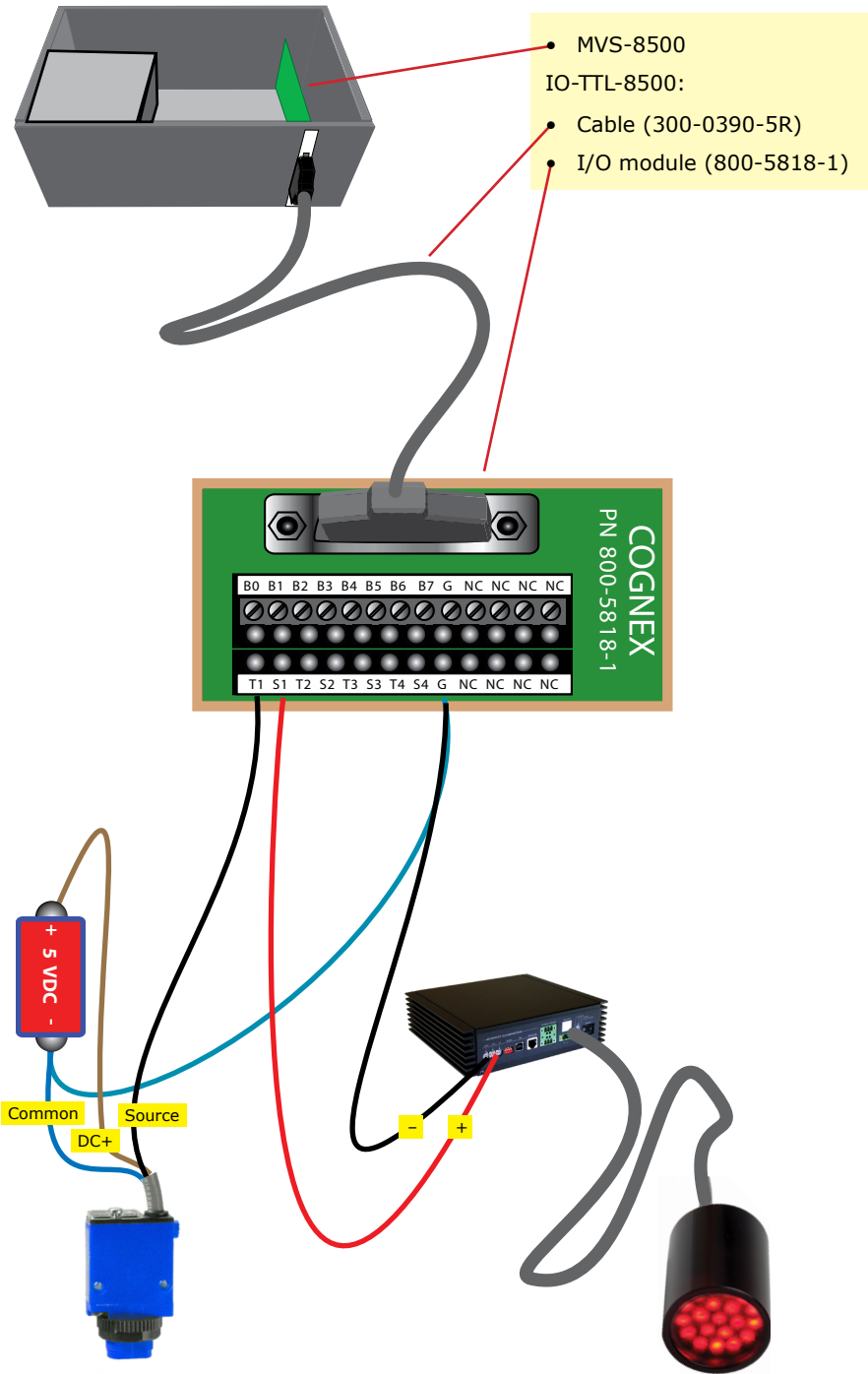

Trigger

Strobe (TTL Controller)

MVS-8600 Opto-Isolated Trigger and Strobe (Area Scan)

Both TTL and Opto-Isolated trigger and strobe wiring are supported through the CIO-8600-LVDS and CIO-8600-TTL I/O module kits.

If you are using an area scan camera, then you can use either CIO-8600-LVDS or CIO-8600-TTL; the only difference between these kits is which type of encoder they support.

Keep in mind that you must specify, in software, which I/O configuration you are using.

General Wiring Notes

The I/O module provides both +5V and +12V power for TTL and Opto-Isolated devices. This power is supplied by the MVS-8600 through the Hirose connector.

The I/O module provides separate labeled connections for TTL strobe outputs (1 and 2), TTL trigger inputs (1 and 2), Opto-isolated strobe outputs (1 and 2), and Opto-isolated trigger outputs (1 and 2). Each connection point is clearly labeled on the I/O module.

For more information:

- See the MVS-8600 Hardware Manual.

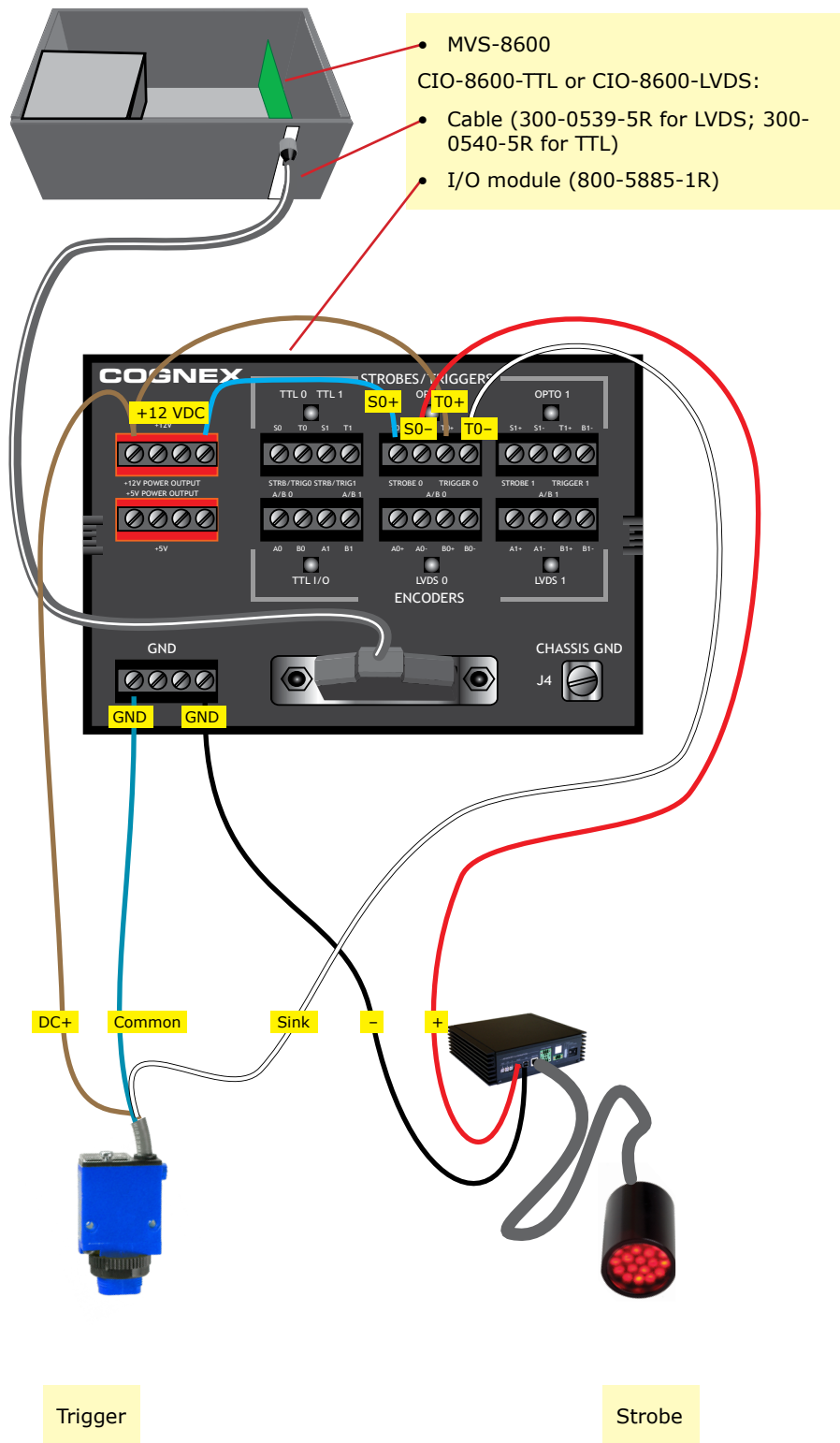

MVS-8600 TTL Trigger and Strobe (Area Scan)

Both TTL and Opto-Isolated trigger and strobe wiring are supported through the CIO-8600-LVDS and CIO-8600-TTL I/O module kits.

If you are using an area scan camera, then you can use either CIO-8600-LVDS or CIO-8600-TTL; the only difference between these kits is which type of encoder interface (TTL or LVDS) they support.

Keep in mind that you must specify, in software, which I/O configuration you are using.

General Wiring Notes

The I/O module provides both +5V and +12V power for TTL and Opto-Isolated devices. This power is supplied by the MVS-8600 through the Hirose connector.

The I/O module provides separate labeled connections for TTL strobe outputs (1 and 2), TTL trigger inputs (1 and 2), Opto-isolated strobe outputs (1 and 2), and Opto-isolated trigger outputs (1 and 2). Each connection point is clearly labeled on the I/O module.

For more information:

- See the MVS-8600 Hardware Manual.

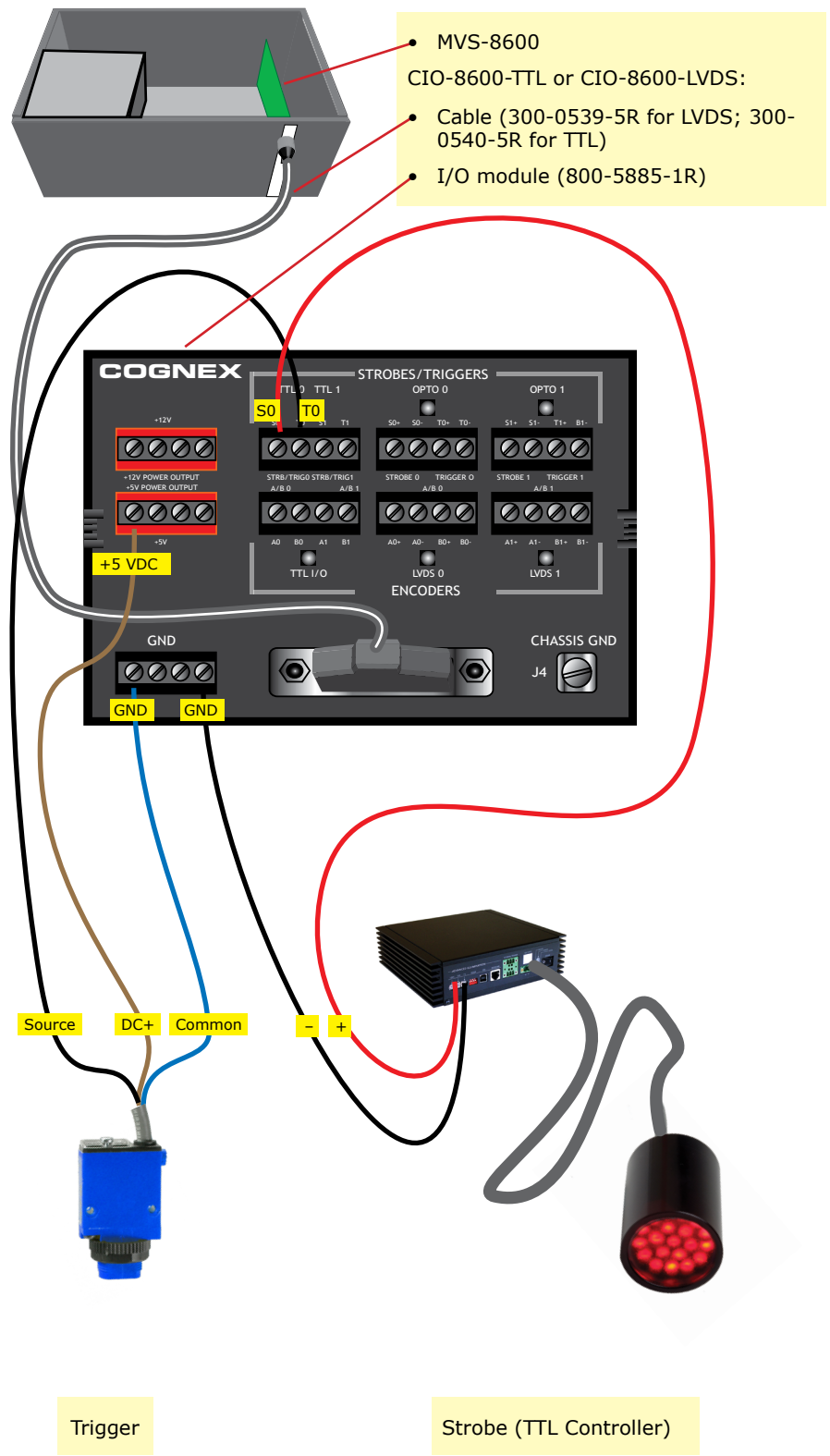

MVS-8600 Opto-Isolated General-Purpose I/O

On the MVS-8600, opto-isolated programmable I/O is supported through the CIO-8600-GPIO kit.

General Wiring Notes

Adjacent pairs of input lines share a common VDC+ pin, so if you want to use all the lines, you must wire the MVS-8600 as a current sink.

In addition to the general-purpose I/O lines, this module also provides access to TTL-level trigger and strobe connections. If you are using the Dual-LVDS configuration, you must use these lines to trigger your cameras, but for other configurations Cognex recommends that you use the appropriate I/O module for access to these lines. The I/O module also provides access to supplemental camera power outputs and both TTL and LVDS encoder inputs. Cognex recommends not using the camera power outputs and using the appropriate I/O module for encoder connections (those connections are shown in blue in the table).

Signal Names

The following table maps module lines to VisionPro software lines and Communications Explorer line names. The "Label" name refers to the printed label on the I/O module.

Label	P4/P6 Pin	P4 Block Signal	P6 Block Signal
1	1	OUTPUT 1 +	OUTPUT 5 +
2	3	OUTPUT 1 -	OUTPUT 5 -
3	5	INPUT 0 & 1 +	INPUT 4 & 5 +
4	7	INPUT 0 -	INPUT 4 -
5	9	INPUT 1 -	INPUT 5 -
6	11	ENCODER0 A+ (800-5885-1R)	STROBE 0 / ENCODER1 A+ (800-5885-1R)
7	13	ENCODER0 A- (800-5885-1R)	STROBE 1 / ENCODER1 A- (800-5885-1R)
8	15	CAMERA 1 POWER VDC+ (NR)	CAMERA 1 POWER VDC+ (NR)
9	17	OUTPUT 2 +	OUTPUT 6 +
10	19	OUTPUT 2 -	OUTPUT 6 -
11	21	INPUT 2 & 3 +	INPUT 6 & 7 +
12	23	INPUT 2 -	INPUT 6 -
13	25	INPUT 3 -	INPUT 7 -
14	2	VDC+ INPUT FOR OUTPUT LINES 0-3	VDC+ FOR OUTPUT LINES 4-7
15	4	OUTPUT 0 +	OUTPUT 4 +
16	6	OUTPUT 0 -	OUTPUT 4 -
17	8	GROUND	GROUND
18	10	CAMERA 0 POWER VDC+ (NR)	CAMERA 0 POWER VDC+ (NR)
19	12	GROUND	GROUND
20	14	N/C	N/C
21	16	GROUND	GROUND
22	18	OUTPUT 3 +	OUTPUT 7 +
23	20	OUTPUT 3 -	OUTPUT 7 -
24	22	ENCODER0 B+ (800-5885-1R)	TRIGGER 0 / ENCODER1 B+ (800-5885-1R)
25	24	ENCODER0 B- (800-5885-1R)	TRIGGER 1 / ENCODER1 B- (800-5885-1R)

For more information:

- See the MVS-8600 Hardware Manual.

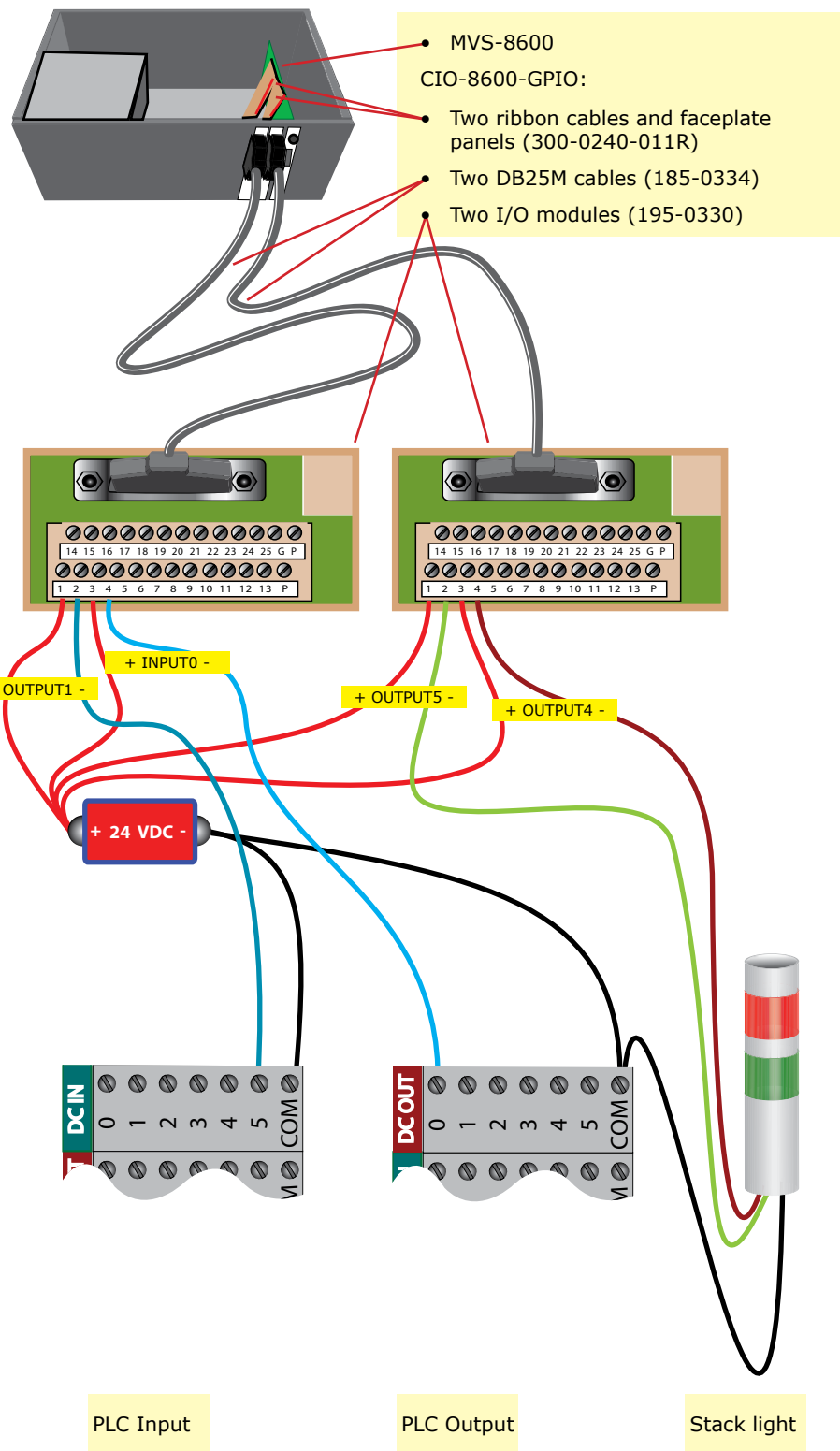

- MVS-8600
- CIO-8600-GPIO:
- Two ribbon cables and faceplate panels (300-0240-011R)
- Two DB25M cables (185-0334)
- Two I/O modules (195-0330)

MVS-8600 Single LVDS Encoder (Line Scan)

To connect a single LVDS encoder for use with one or two line scan cameras, use the CIO-8600-LVDS I/O kit. This configuration lets you connect trigger inputs, strobe outputs, and LVDS encoder inputs for a single line scan camera, one line scan and one area scan camera, or two line scan cameras sharing a single LVDS encoder.

General Wiring Notes

The MVS-8600 clamps encoder inputs to +5V. Cognex recommends that you use encoders that output no more than +5VDC.

Both TTL and opto-isolated trigger and strobe connections are supported.

Keep in mind that you must specify, in software, which I/O configuration you are using.

For more information:

- See MVS-8600 Hardware Manual.
- See the Cognex Line Scan Acquisition White Paper available at: <http://support.cognex.com>
- See the Cognex Technical Bulletin on Selecting Encoders available at: <http://support.cognex.com>
- See topics on I/O line numbering and Communications Explorer in VisionPro online documentation.

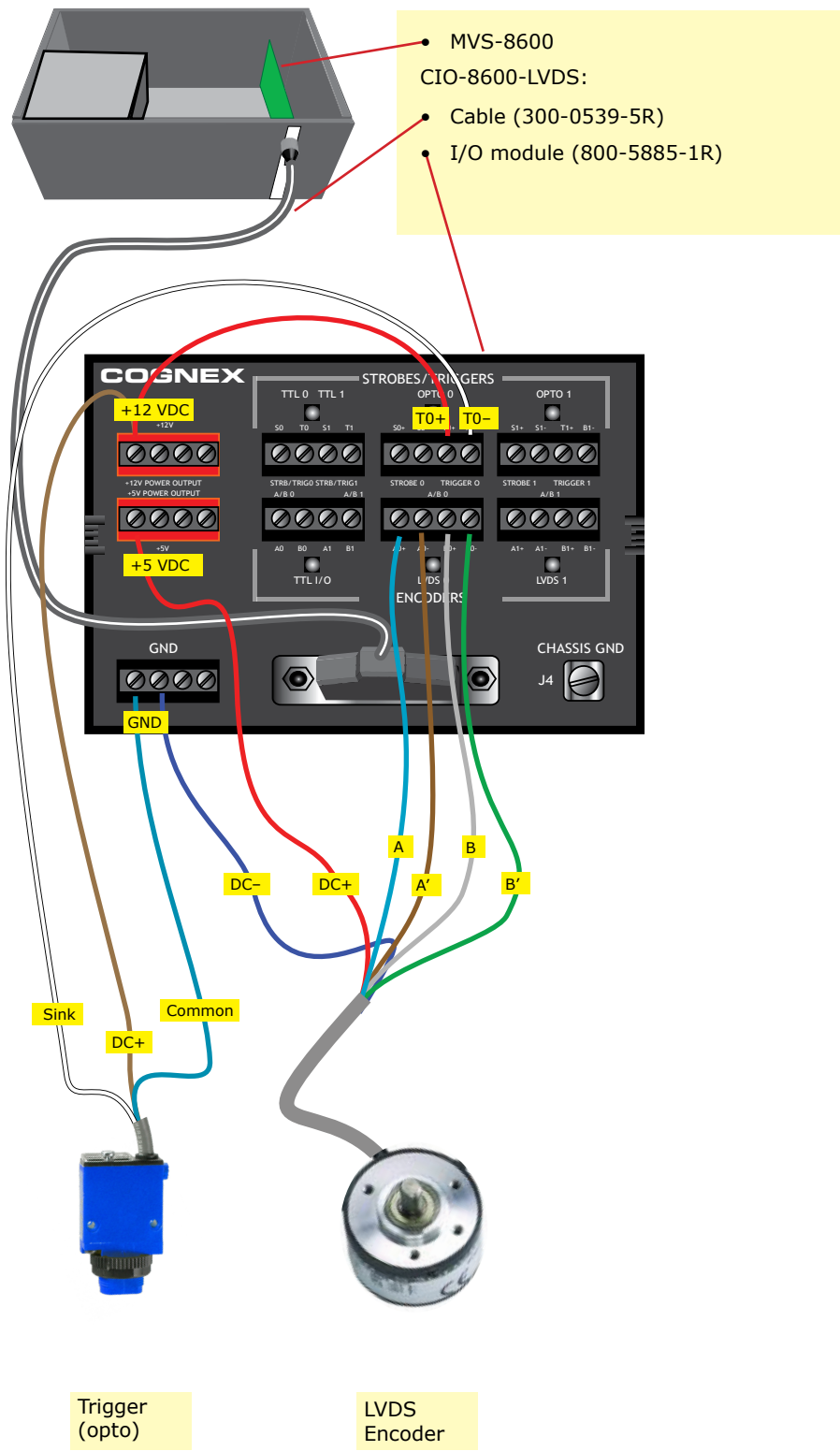

MVS-8600 Dual LVDS Encoder (Line Scan)

To connect dual LVDS encoders for use with a line scan camera, use the CIO-8600-DLVDS I/O kit. This configuration lets you connect LVDS encoder inputs from two LVDS encoders. Unlike the single LVDS or single/dual TTL configurations, the dual LVDS configuration does not allow you to connect any trigger inputs or strobe outputs directly to the I/O module.

Instead, use the CIO-8600-DLVDS-TRG kit to connect a trigger input or inputs (opto-isolated only).

General Wiring Notes

The MVS-8600 clamps encoder inputs to +5V. Cognex recommends that you use encoders that output no more than +5VDC.

In addition to providing for trigger inputs, the CIO-8600-GPIO kit also provides full access to the general-purpose programmable input and output lines.

Keep in mind that you must specify, in software, which I/O configuration you are using.

For more information:

- See MVS-8600 Hardware Manual.
- See the Cognex Line Scan Acquisition White Paper available at: <http://support.cognex.com>
- See the Cognex Technical Bulletin on Selecting Encoders available at: <http://support.cognex.com>

See topics on I/O line numbering and Communications Explorer in VisionPro online documentation.

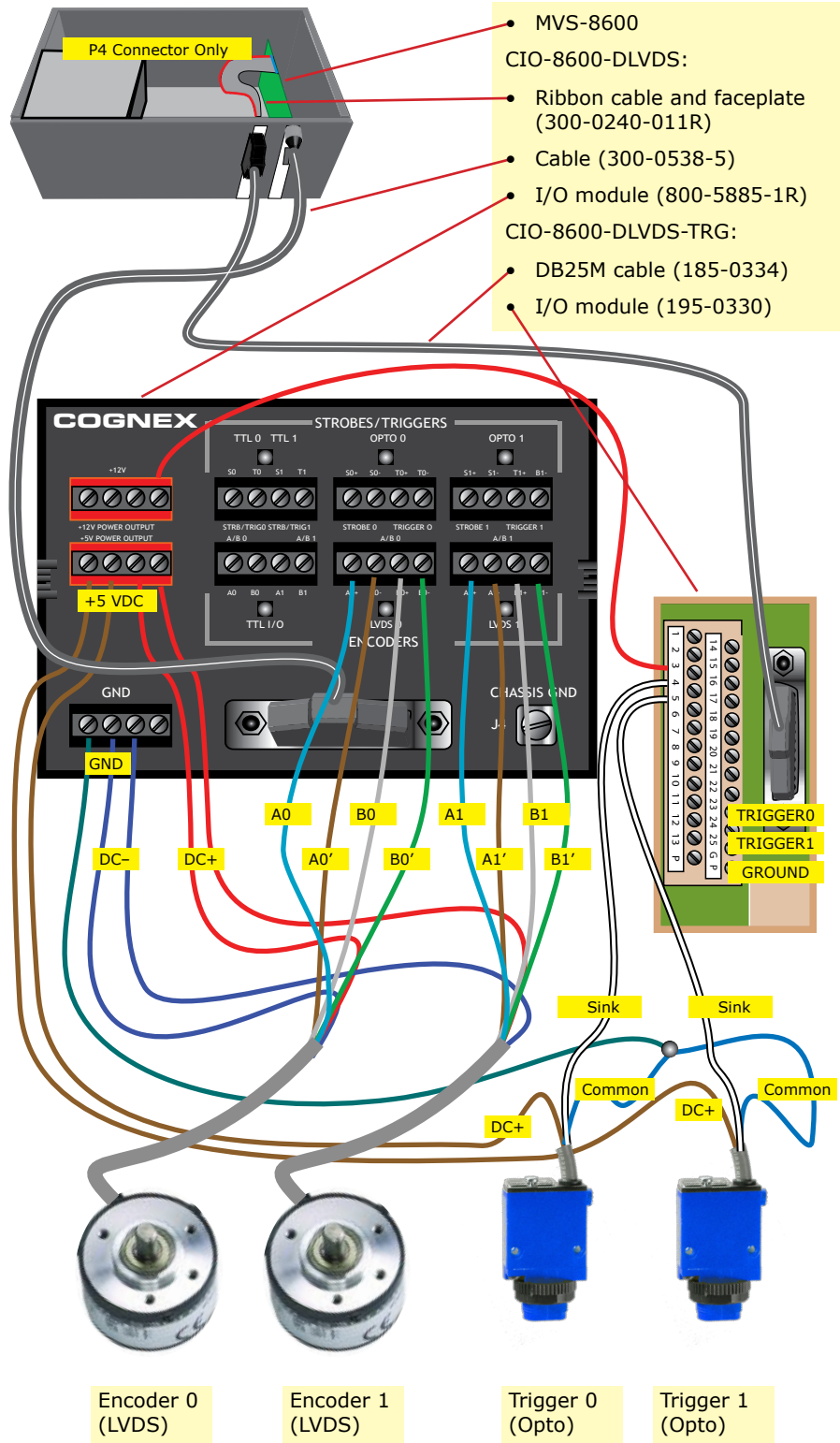

- MVS-8600
- CIO-8600-DLVDS:
- Ribbon cable and faceplate (300-0240-011R)
- Cable (300-0538-5)
- I/O module (800-5885-1R)
- CIO-8600-DLVDS-TRG:
- DB25M cable (185-0334)
- I/O module (195-0330)

MVS-8600 Single/Dual TTL Encoder (Line Scan)

To connect a single or dual TTL encoder for use with a line scan camera or cameras, use the CIO-8600-TTL I/O kit. This configuration lets you connect TTL encoder inputs from two TTL encoders. You can also connect TTL or opto-isolated trigger inputs for 1 or 2 line scan cameras.

General Wiring Notes

Both TTL and opto-isolated trigger and strobe connections are supported.
 Keep in mind that you must specify, in software, which I/O configuration you are using.

For more information:

- See MVS-8600 Hardware Manual.
- See the Cognex Line Scan Acquisition White Paper available at: <http://support.cognex.com>

See topics on I/O line numbering and Communications Explorer in VisionPro online documentation.

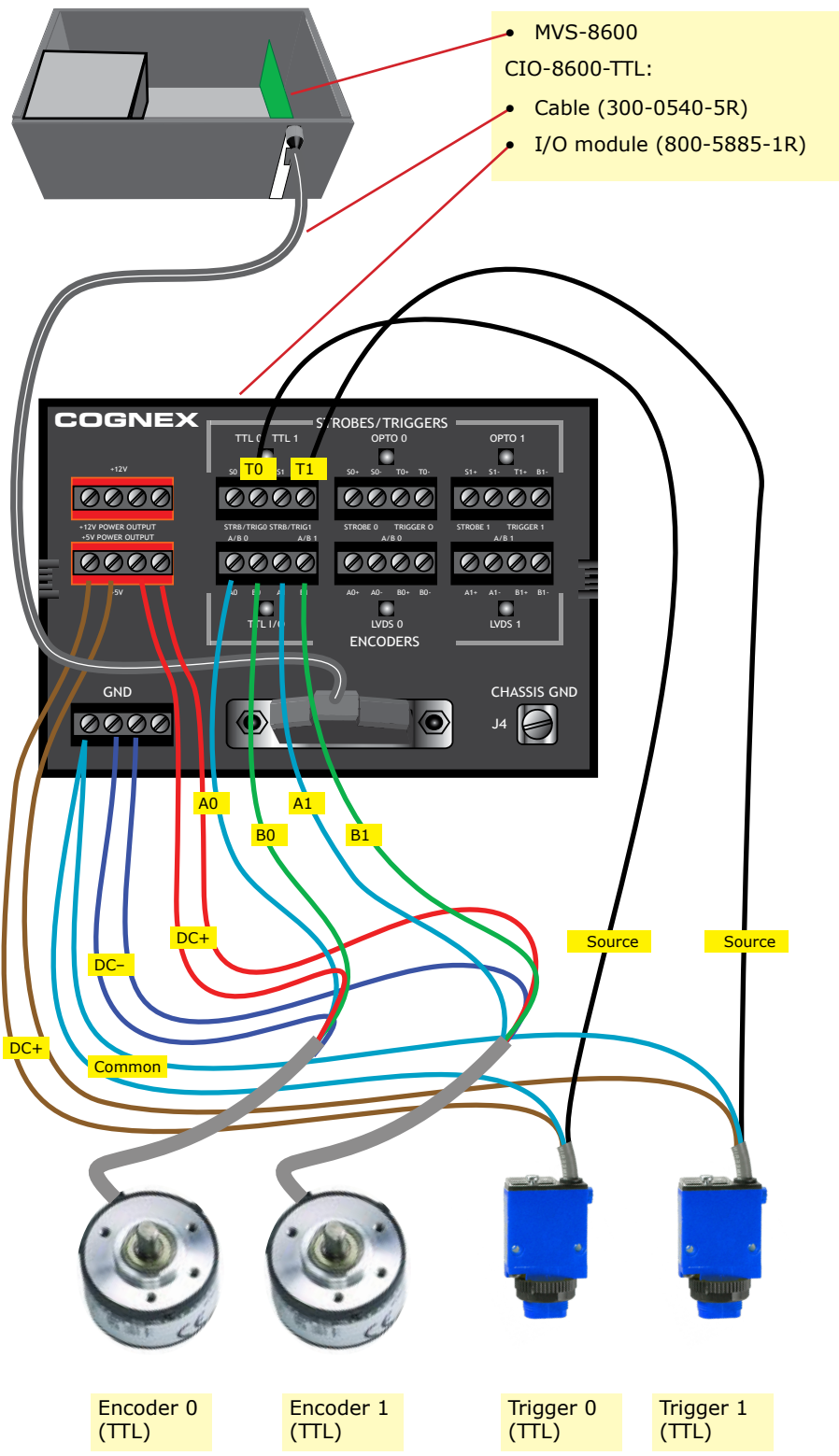

MVS-8704e 4-Port GigE Vision Frame Grabber

The MVS-8704e is a 4-port GigE Vision frame grabber that supports the Power over Ethernet (PoE) standard. Use an MVS-8704e as a dedicated network interface card (NIC) for GigE Vision cameras.

► **You must use the Cognex GigE Vision Configurator to configure all connected cameras before using them.**

Camera power and ground depends on the specific camera you are using, and can be supplied through the RJ-45 Ethernet connector or through the connector on the camera. See your camera documentation for more information.

General Wiring Notes

The wiring diagram to the right displays one PoE Gige Vision camera and one GigE Vision camera that does not support PoE.

A trigger and strobe I/O cable (COG-IO-CBL-6P-10M or COG-IO-CBL-6P-PLC) provides access to trigger and strobe connections as well as power.

For more information:

- See the MVS-8700 Series Hardware Manual
- See the GigE Vision guide supplied with VisionPro.

